

element • Roku TV



QUICK START GUIDE

MODEL # E4SC4018RKU

4K

ULTRA HD

3840 x 2160 RESOLUTION

IMPORTANT SAFETY INSTRUCTIONS

- **Read these instructions** - All the safety and operating instruction should be read before this product is operated.
- **Keep these instructions** - The safety and operating instruction should be retained for future reference.
- **Heed all warnings** - All warnings on the appliance and in the operating instructions should be adhered to.
- **Follow all instructions** - All operating and use instructions should be followed.
- **Do not use this apparatus near water** - The appliance should not be used near water or moisture - for example, in a wet basement or near a swimming pool, and the like.
- Clean only with dry cloth.
- **Do not** block any ventilation openings . Install in accordance with the manufacturer's instructions.
- **Do not** in stall near any heat sources such as radiators, heat registers, stoves, or other apparatus (including amplifiers) that produce heat.
- **Do not** defeat the safety purpose of the polarized or grounding-type plug. A polarized plug has two blades with one wider than the other. A grounding-type plug has two blades and a third grounding prong. The wide blade or the third prong are provided for your safety. If the provided plug does not fit into your outlet, consult an electrician for replacement of the obsolete outlet.
- Protect the power cord from being walked on or pinched particularly at plugs, convenience receptacles, and the point where they exit from the apparatus.
- Only use attachments/accessories specified by the manufacturer.
- Use only with the cart, stand, tripod, bracket, or table specified by the manufacturer, or sold with the apparatus. When a cart is used, use caution when moving the cart/apparatus combination to avoid injury from tip-over.



- Unplug this apparatus during lightning storms or when unused for long periods of time.
- Refer all servicing to qualified service personnel. Servicing is required when the apparatus has been damaged in any way, such as power-supply cord or plug is damaged, liquid has been spilled or objects have fallen into the apparatus, the apparatus has been exposed to rain or moisture, does not operate normally, or has been dropped.

- Please keep the unit in a well-ventilated environment.

WARNING: To reduce the risk of fire or electric shock, do not expose this apparatus to rain or moisture. The apparatus should not be exposed to dripping or splashing. Objects filled with liquids, such as vases should not be placed on apparatus.

WARNING: The batteries shall not be exposed to excessive heat such as sunshine, fire or the like.

WARNING: The main plug is used as disconnect device, the disconnect device shall remain readily operable.

WARNING: To reduce the risk of electric shock, do not remove cover (or back) as there are no user-serviceable parts inside. Refer servicing to qualified personnel.



This lightning flash with arrowhead symbol within an equilateral triangle is intended to alert the user to the presence of non-insulated "dangerous voltage" within the product 's enclosure that may be of sufficient magnitude to constitute a risk of electric shock.



The exclamation point within an equilateral triangle is intended to alert the user to the presence of important operating and maintenance instructions in the literature accompanying the appliance.



This equipment is a Class II or double insulated electrical appliance. It has been designed in such a way that it does not require a safety connection to electrical earth.



This product contains electrical or electronic materials. The presence of these materials may, if not disposed of properly, have potential adverse effects on the environment and human health. Presence of this label on the product means it should not be disposed of as unsorted waste and must be collected separately. As a consumer, you are responsible for ensuring that this product is disposed of properly.

ROKU, ROKU TV and the ROKU logo are the trademarks or registered trademarks of Roku, Inc. All other trademarks and logos herein are the property of their respective owners.

WHAT'S INCLUDED

- TV Set
- Remote Control with 2 (AAA) Batteries
- Quick Start Guide
- TV Stand
- 4 pcs (M4 x 25 mm) screws



Stand



Element Roku TV



Remote control

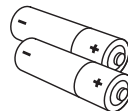

2 x AAA batteries
for remote control

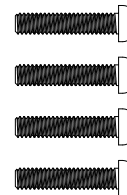

4 screws

WHAT YOU NEED (not included)

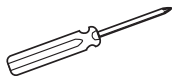

Phillips head screwdriver

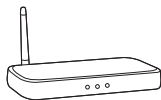

Wireless router
(needed for streaming)



Computer, tablet or
smart phone
(needed for setup)

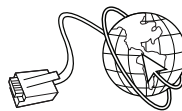

Internet connection
(needed for streaming)

For additional support, please see User Manual at www.elementelectronics.com.

Key things to know: A paid subscription or other payments may be required for some streaming channels. Channel availability subject to change and varies by country.

INSTALLING THE BASE

I. UNPACK TV & STAND

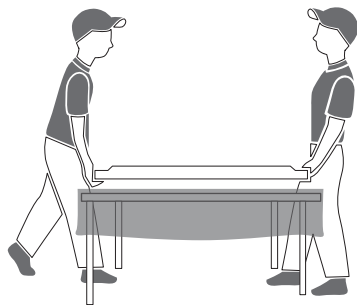

It is recommended that two people take part in the stand installation. Remove any plastic wrapping from the TV and stand.

Place the TV screen down on a clean, flat surface. To prevent scratches or damage to the screen, place the TV on a soft surface such as a carpet, rug, or blanket and avoid any sharp edges.

2. ATTACH STAND

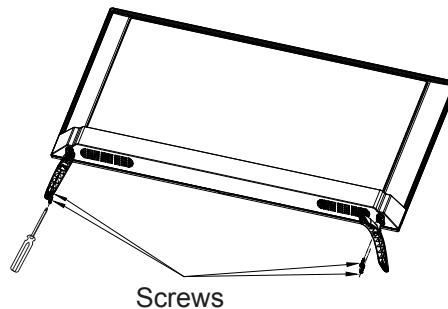

Install Bridge-Shaped stand to the TV. Secure the stand to the TV with the (4) screws included. Insert the screws into the bottom of the TV and tighten them using a screw driver.











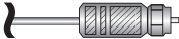

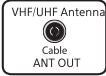

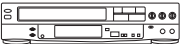

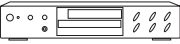

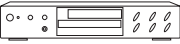







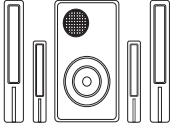

When you are finished, place the TV on a stable and level surface.

CONNECT DEVICES TO YOUR TV

Check to ensure that you have selected the right cables for the ports and that they are connected securely.

Loose connections can affect the quality of the picture image and color. (Cables and External Equipment not included.)

TV label	Port	Cable	External Equipment	Brief Description	
RF (75Ω)			 Antenna  VHF/UHF Antenna Cable ANT OUT	Connect an outdoor or indoor antenna.	
HDMI				Connect a High Definition Multimedia Interface (HDMI®) cable from an external device.	
AV IN	CVBS		 Yellow		Connect a composite video cable and left-right audio cables from an external AV device.
	AUDIO-L		 White		
	AUDIO-R		 Red	 Video Camera  Set-top Box  Satellite Receiver  Satellite antenna cable	
OPTICAL			 Audio Amplifier  Speaker	Connect an optical cable from an external digital audio system.	

TV label	Port	Cable	External Equipment	Brief Description
				Connect headphone for audio out of the TV.
LAN			 LAN	Connect an Ethernet cable to access a network or the Internet. The TV also has a wireless connectivity feature.
USB 5V \pm 500mA				Connect a USB device for browsing photos, music and movies. Use a USB drive 16GB or larger for pausing Live TV while watching Antenna TV. The unit only recognizes a USB Memory Stick.
RESET		Restart or factory reset your TV.		

SETTING UP YOUR TV

1. Place Batteries in Remote

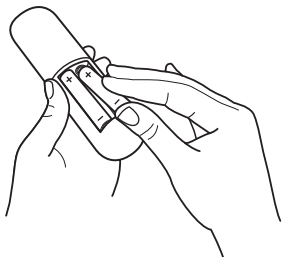

Power your TV remote by inserting the included batteries carefully matching (+) and (-) indicated inside the battery compartment.

TIP: Always replace dead batteries with two brand-new batteries from the same manufacturer. Never use damaged batteries.

If your remote gets warm/hot during use, discontinue use and contact customer support immediately.

2. Plug in and turn on TV

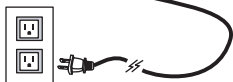
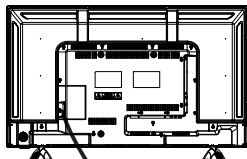

Connect your power cord to the TV, then plug it in to the wall outlet.



Press the power button on your TV remote control.

3. Follow the on screen instructions



Once your Roku TV powers on, follow the on-screen instructions. Your Roku TV will walk you through initial setup and help connect to your preferred wireless network.

Your TV will automatically detect wireless networks in your area. Have your network name and password handy and follow the easy on-screen instructions.

Once connected your TV will automatically update with the latest software. This can take a few minutes to update.

If you aren't ready to connect your TV to a wireless network, you can still use it as a regular TV.

4. Activate your smart TV

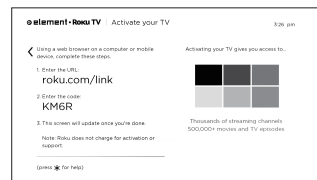

You need a Roku account to activate your Roku TV and access entertainment across thousands of streaming channels.

From your smartphone, tablet, or computer, go to www.roku.com/link and enter the unique link code that is displayed on your TV screen.

NOTE: Roku does not charge for activation support - **beware of scams.**

Roku accounts are free and while a valid credit card number is not required to create a Roku account, saving your credit card information makes renting and purchasing entertainment from the Roku Channel Store fast and convenient.

CONNECTING AN ANTENNA (optional)

With the built-in tuner you can connect your TV to an antenna and enjoy over-the-air entertainment.

1. When the setup wizard is complete select the Antenna TV icon from the home screen
2. Follow the on-screen instructions.
3. Whenever you want to watch antenna TV, select the Antenna icon.



4. Live TV Pause feature: Pause up to 90 minutes of live antenna TV when you connect a 16 GB or larger USB drive to your TV.

UNIVERSAL REMOTE SETUP

Using your Cable Set-top Box or Satellite Receiver Remote as a Universal Remote.

If you prefer to use your cable set-top box or satellite receiver remote as a Universal Remote, please refer to the manual that your cable or satellite service provided. It includes instructions on how to program their remote to your television. You can find codes that work with your Element Roku TV and the most common cable and satellite provider's universal remote control at www.roku.com/universalremote.

REMOTE CONTROL

The Roku TV remote should feel right at home in your hand. We designed it to be incredibly intuitive for watching TV and navigating on-screen menus.

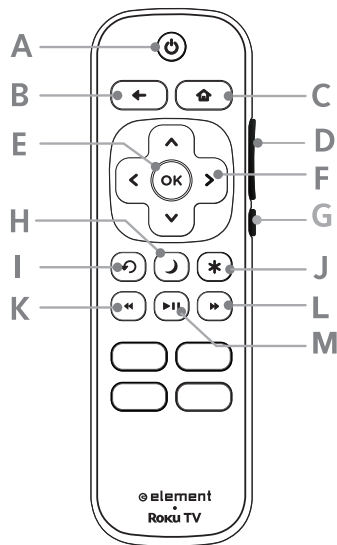

(Remotes may vary)

- A. **POWER** Turn TV on and off
- B. **BACK** Return to previous screen
- C. **HOME** Return to Roku Home screen
- D. **VOLUME** Raise and lower volume
- E. **OK** Select an option from a menu
- F. **UP or DOWN** Move up or down;
LEFT or RIGHT Move left or right
- G. **MUTE** Mute and restore sound
- H. **SLEEP** Set the sleep timer
- I. **INSTANT REPLAY** Replay the last few seconds of streaming video
- J. **OPTIONS** Access to picture settings, more streaming channel icons and more
- K. **RWD SCAN** Rewind streaming video, scroll left one page at a time
- L. **FWD SCAN** Fast forward streaming video, scroll right one page at a time
- M. **PLAY/PAUSE** Start or pause playback

D-Pad Left: Brings up the Smart Guide (EPG) while watching Antenna TV.

Play/Pause: Pauses and resumes Live TV while watching Antenna TV.

REW: Rewinds the paused Live TV Pause buffer.

FF: Fast forwards the paused Live TV Pause buffer.

D-Pad Left and D-Pad Right: Choose scenes while using Live TV Pause.

TIP: The button gives you easy access to picture settings, display options and more. Try it on every screen.

ELEMENT LCD TV LIMITED WARRANTY TO ORIGINAL CONSUMER LCD TV– 40 inches and under Screen Size Models (the “Product”)

This Product (including any accessories included in the original packaging) as supplied and distributed in new condition, is warranted by Element TV Company, LP (“Element”) to the original purchaser against defects in material and workmanship (“Warranty”) as follows:

1. **WARRANTY SERVICE (Parts, Labor and/or Replacement):** For a period of two (2) years from the date of the original customer purchase (“the Warranty Period”), if this Product or any of its parts are determined by Element or an Element authorized customer service provider to be defective in material or workmanship, Element will, at its sole discretion and option: (i) supply, at no charge to the original customer, new or rebuilt replacement parts in exchange for defective parts, (ii) repair the Product and pay the labor charges of such Element authorized service provider for same, at no charge to the original customer, (iii) replace the Product with a new or refurbished product of similar or better quality, at no charge to the original customer, or (iv) refund the original purchase price of the Product (excluding tax) to the original customer. After the Warranty Period, the customer must pay for all parts, labor and replacement costs associated with the Product, regardless of any defects in the Product.

A. **SHIPPING COSTS:** Notwithstanding the foregoing, the customer is responsible for any shipping or transportation charges incurred to ship or otherwise deliver the Product or part(s) to Element or an Element authorized service provider for diagnosis, repair or replacement. The customer shall not return the Product to Element without Element’s prior written consent. Element recommends that the customer insure the Product for its full replacement cost when shipping.

B. **TIMING AND PROCEDURE:** Before Warranty service can commence, the original customer purchaser must contact Element for problem determination and service procedures. Proof of purchase in the form of a bill of sale or receipted invoice, evidencing that the Product is within the Warranty Period, MUST be presented to an Element authorized customer service provider in order to obtain the requested service. Please call the Toll Free Customer Service Line at (888) 842-3577 to obtain Warranty Service and Troubleshooting information. Please have your model and serial number available, along with your date of purchase of the Product. You can also visit us online at: www.elementelectronics.com.

2. **EXCLUSIONS AND LIMITATIONS TO WARRANTY SERVICE:** This Warranty covers manufacturing defects in materials and workmanship encountered in the normal, non-commercial use of the Product, and does not cover (a) damage or failure caused by or attributable to Product abuse or misuse, failure to follow instructions, improper installation or maintenance, alteration, accident, or excess voltage or current; (b) improper or incorrectly performed repairs by non-authorized service facilities; (c) onsite customer instruction or adjustments; (d) transportation, shipping, delivery, insurance, installation or set-up costs; (e) costs of product removal, transportation or reinstallation costs; (f) ordinary wear and tear, cosmetic damage or damage due to acts of nature, including but not limited to water, floods, wind, tornado, earthquake or fire, or due to damage caused by automobile accidents or extraordinary impact events, such as dropping or crushing; (g) commercial use of the Product; (h) modification of the Product or to any part of the Product. In addition, this Warranty does not cover images “burnt” into the screen.

This Warranty applies to the original consumer only and does not cover Products sold AS IS or WITH ALL FAULTS, or consumables (e.g., fuses, batteries, bulbs etc.).The Warranty is invalid if the factory-applied serial number has been altered or removed from the Product. This Warranty is valid only in the United States and Canada, and only applies to products purchased and serviced in the United States and Canada. All replaced parts and Products, and Products on which a refund is made, become the property of Element. The addition of equipment or features to the Product that are not manufactured or recommended by Element could affect the intended function of the Product, and therefore may void the Warranty. The Warranty is contingent upon the proper use, maintenance and care of the Product. The Warranty may be void if the Product has been used in a manner contradictory to or in violation of the terms of the user's manual, warnings or instructions accompanying the Product.

This Warranty is made in lieu of and supersedes all other warranties or conditions of merchantability or fitness for a particular purpose or general use, whether express, implied, collateral, statutory, or provided by common law, the Uniform Commercial Code or otherwise. Element further disclaims all warranties after the end of the Warranty Period defined above. No other express warranty or guaranty given by any other person, firm or entity with respect to the Product shall be binding on Element. Repair, replacement, or refund of the original purchase price, at Element's sole discretion, are the exclusive remedies of the customer. Element shall not be liable for any incidental or consequential damages caused by the use, misuse or inability to use the Product. These include but are not limited to any damages in the form of lost profits, loss of use, legal fees, economic loss, personal injuries, or any other damages caused by circumstances beyond the control of Element. Notwithstanding the foregoing, the customer's recovery shall not exceed the purchase price of the Product. This Warranty shall not extend to anyone other than the original customer who purchased the Product, and is not transferrable. No person is authorized to alter, extend or waive the Warranty of Element.

Some states do not allow the exclusion or limitation of incidental or consequential damages, or allow limitations on warranties, so the above limitations or exclusions may not apply to you. This Warranty gives you specific rights, and you may have other rights, which vary from state to state. The exclusions and limitations to the Warranty apply to the maximum extent permitted by law and unless restricted or prohibited by law. Where any term of this Warranty is prohibited by applicable law, it shall be null and void, but the remainder of this Warranty shall remain in effect.

PLEASE DIRECT ALL CORRESPONDENCE TO:

Element TV Company, LP Customer Service
customerservice@elementelectronics.com
(888) 842-3577
www.elementelectronics.com

PLEASE CONTACT CUSTOMER SERVICE TO CONFIRM ADDRESSES AND PROCEDURES FOR WARRANTY SERVICE.

TAKE A MOMENT TO REGISTER YOUR PRODUCT AT: Elementelectronics.com/product-registration

Why Register?



Customized Support

Get assistance quickly by pre-registering your product.



News & Offers

Take advantage of the latest news and special offers from Element.



Safety & Satisfaction

Stay up-to-date with important product updates and notifications.

DO YOU HAVE QUESTIONS? FIND ANSWERS.

<http://www.elementelectronics.com/>

Find help with:

- New product setup
- Connecting your devices
- Technical problems
- Product updates and more

You can also contact our award-winning support team at:

Phone: (888) 842-3577

Email: customerservice@elementelectronics.com

Hours of Operation:

24 hours a day/ 7 days a week (except major holidays)

Element Roku TV setup support:

go.roku.com/roktv

Download the Roku TV User Guide at:

<https://go.roku.com/tvmanual>

Download the complete User Manual at:

<https://www.elementelectronics.com/>

© **element** • **Roku TV**

Free Manuals Download Website

<http://myh66.com>

<http://usermanuals.us>

<http://www.somanuals.com>

<http://www.4manuals.cc>

<http://www.manual-lib.com>

<http://www.404manual.com>

<http://www.luxmanual.com>

<http://aubethermostatmanual.com>

Golf course search by state

<http://golfingnear.com>

Email search by domain

<http://emailbydomain.com>

Auto manuals search

<http://auto.somanuals.com>

TV manuals search

<http://tv.somanuals.com>