

***Emerson***<sup>®</sup>

***Stereo Radio, CD-R/RW Player  
with Dual Alarm Clock***

***OWNER'S MANUAL***

***CKD1100 (Silver Color)***

***CKD1100BL (Blue Color)***

***CKD1100GN (Green Color)***



***CKD1100PK (Pink Color)***

Visit our web site at [www.emersonradio.com](http://www.emersonradio.com)



## CAUTION

TO PREVENT FIRE OR SHOCK HAZARD, DO NOT USE THIS PLUG WITH AN EXTENSION CORD, RECEPTACLE OR OTHER OUTLET UNLESS THE BLADES CAN BE FULLY INSERTED TO PREVENT BLADE EXPOSURE. TO PREVENT FIRE OR SHOCK HAZARD, DO NOT EXPOSE THIS APPLIANCE TO RAIN OR MOISTURE.

 <p>The lightning flash with arrow-head symbol, within an equilateral triangle is intended to alert the user to the presence of uninsulated 'dangerous voltage' within the product's enclosure that may be of sufficient magnitude to constitute a risk of electric shock to persons.</p>	<p style="text-align: center;"><b>CAUTION</b> RISK OF ELECTRIC SHOCK DO NOT OPEN</p> <p><b>WARNING: TO REDUCE THE RISK OF ELECTRIC SHOCK DO NOT REMOVE COVER (OR BACK), NO USER SERVICEABLE PARTS INSIDE REFER SERVICING TO QUALIFIED SERVICE PERSONNEL.</b></p>	 <p>The exclamation point within an equilateral triangle is intended to alert the user to the presence of important operating and maintenance (servicing) instructions in the literature accompanying the appliance.</p>
--	--	---

The Caution Marking maybe located at the bottom enclosure of the apparatus.

## IMPORTANT SAFETY INSTRUCTIONS

- 1.) Read these instructions. Keep these instructions. Follow all instructions. Heed all warnings.
- 2.) Do not use this apparatus near water.
- 3.) Clean only with dry cloth.
- 4.) Do not block any ventilation openings. Install in accordance with the manufacturer's instructions.
- 5.) Do not install near any heat sources such as radiators, heat registers, stoves, or other apparatus (including amplifiers) that produce heat.
- 6.) Do not defeat the safety purpose of the polarized or grounding-type plug. A polarized plug has two blades with one wider than the other. A grounding type plug has two blades and a third grounding prong. The wide blade or the third prong is provided for your safety. If the provided plug does not fit into your outlet, consult an electrician for replacement of the obsolete outlet.
- 7.) Protect the power cord from being walked on or pinched particularly at plugs, convenience receptacles, and the point where they exit from the apparatus.
- 8.) Only use attachments / accessories specified by the manufacturer.
- 9.) Unplug this apparatus during lightning storms or when unused for long periods of time.
- 10.) Refer all servicing to qualified service personnel. Servicing is required when the apparatus has been damaged in any way, such as power-supply cord or plug is damaged, liquid has been spilled or objects have fallen into the apparatus, the apparatus has been exposed to rain or moisture, does not operate normally, or has been dropped.
- 11.) This appliance shall not be exposed to dripping or splashing water and no object filled with liquids such as vases shall be placed on the apparatus.
- 12.) Use only with the cart, stand, tripod, bracket, or table specified by the manufacturer, or sold with the apparatus. When a cart is used, use caution when moving the cart/apparatus combination to avoid injury from tip-over.
- 13.) Do not overload wall outlet. Use only power source as indicated.
- 14.) Use replacement parts as specified by the manufacturer.
- 15.) The product may be mounted to a wall only if recommended by the manufacturer.
- 16.) Upon completion of any service or repairs to this product, ask the service technician to perform safety checks.



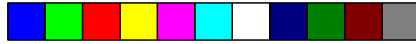

## Before We Begin

Thank you for purchasing this Emerson audio product. The Emerson brand is your assurance of quality, performance and value.

Our engineers have included many useful and convenient features in this product. Please be sure to read this Owner's Manual completely to make sure you are getting the maximum benefit from each feature.

This product was manufactured using the highest quality components and standards of workmanship. It was tested by Emerson inspectors and found to be in perfect working order before it left our factory. However, there is always the chance that some problem may occur because of rough handling during shipment to the retail store or to the final consumer.

If, after reading this Manual, you experience any problems with the operation of this product, please refer to the instructions for obtaining service at the end of this Manual. Emerson and Emerson retailers are committed to your satisfaction.

Once again, thanks for purchasing this Emerson audio product.

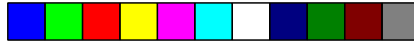

## IMPORTANT NOTES

### CLASS 1 LASER PRODUCT

CLASS 1 LASER PRODUCT  
 APPAREIL À LASER DE CLASSE 1  
 PRODUCTO LASER DE CLASE 1

CAUTION  
 INVISIBLE LASER RADIATION  
 WHEN OPEN AND INTERLOCKS  
 DEFEATED.  
 AVOID EXPOSURE TO BEAM



**This product contains a low power Laser Device.**

- Avoid installing this unit in places exposed to direct sunlight or close to heat radiating appliances such as electric heaters, on top of other stereo equipment that radiates too much heat, places lacking ventilation or dusty areas, places subject to constant vibration and/or humid or moist areas.
- Operate controls and switches as described in the manual.
- Before turning on the power, make certain that the AC power cord is properly installed.
- When moving the set, be sure to first disconnect the AC power cord and remove cords connected to other equipment.

### FCC Information

This equipment has been tested and found to comply with the limits for a class B digital Device, pursuant to part 15 of the FCC Rules. These limits are designed to provide reasonable protection against harmful interference in a residential installation. This equipment generates, uses, and can radiate radio frequency energy and, if not installed and used in accordance with the instructions, may cause harmful interference to radio communications. However, there is no guarantee that interference will not occur in a particular installation. If this equipment does cause harmful interference to radio or television reception, which can be determined by turning the equipment off and on, the user is encouraged to try to correct the interference by one or more of the following measures:

- Reorient or relocate the receiving antenna.
- Increase the separation between the equipment and receiver.
- Connect the equipment into an outlet on a circuit different from that to which the receiver is connected.
- Consult the dealer or an experienced radio/TV technician for help.

This device complies with part 15 of the FCC Rules. Operation is subject to the following two conditions:

- (1) This device may not cause harmful interference, and
- (2) This device must accept any interference received, including interference that may cause undesired operation.

Changes or modifications not expressly approved by the party responsible for compliance could void the user's authority to operate the equipment.

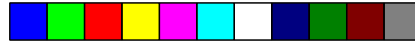

## PREPARATION FOR USE

### Unpacking And Set Up

- Remove the unit from the carton, and remove all packing materials from the unit.
- Save the carton and packing materials in case the unit ever needs to be returned for service. Using the original carton and packing materials is the only way to safely repack the unit for shipment.
- Remove any descriptive labels or stickers from the top or front of the unit. Do not remove any labels from the back or bottom of the cabinet.
- Remove any small strips of tape that may have been used to prevent the CD door from opening in transit.
- Press the CD door in the area marked **OPEN/CLOSE** button to open the CD door and remove the 'dummy CD' protection card from the CD player and discard it. Close the CD door.
- Unwind the FM wire antenna on the back cabinet and extend it to its full length.
- Unwind the AC power cord and extend it to its full length.
- Place the unit on a stable, level surface such as a table, desk, shelf, etc within easy reach of an AC outlet, out of direct sunlight, and away from sources of excessive heat, dust, moisture or humidity.



## Power Source

This system is designed to operate on 120V AC 60Hz house current only. Connecting this system to any other power source may cause damage to the system and such damage is not covered by your warranty.

**NOTE:** The system has polarized AC plug with one wide blade and one narrow blade. The plug will only fit into matching polarized AC outlets.

This is a safety feature to reduce the possibility of electric shock. If the plug will not fit in your AC outlet, you probably have an outdated non-polarized outlet. You should have your outdated outlet changed by a qualified, licensed electrician. Do not file the wide blade on the plug, or use an adapter to make the plug fit into your outlet. This defeats the safety feature and could expose you to electric shock.

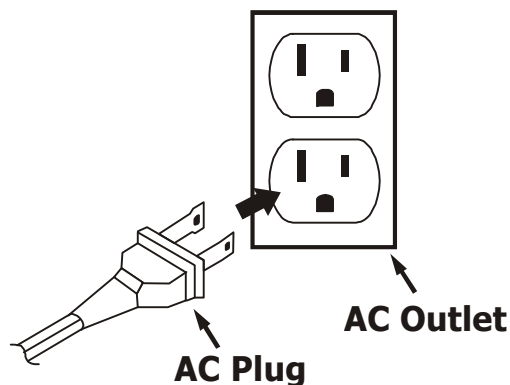

## Protect Your Furniture

This model is equipped with non-skid rubber 'feet' to prevent the product from moving when you operate the controls. These 'feet' are made from non-migrating rubber material specially formulated to avoid leaving any marks or stains on your furniture. However certain types of oil based furniture polishes, wood preservatives, or cleaning sprays may cause the rubber 'feet' to soften, and leave marks or a rubber residue on the furniture. To prevent any damage to your furniture we strongly recommend that you purchase small self-adhesive felt pads, available at hardware stores and home improvement centers everywhere, and apply these pads to the bottom of the rubber 'feet' before you place the product on fine wooden furniture.

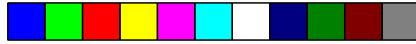

## Battery Back Up System

This unit uses a single 9-Volt battery (not included) to maintain the time and alarm settings in the event that it is accidentally unplugged, or you experience a temporary power failure. We recommend that you install a well-known brand of Alkaline battery for longest life and best performance. To keep the battery back up system operational you should install a new battery every 6 to 9 months.

To install the back up battery, turn the unit upside down.

- 1.) Press on the small tab to remove the battery door.

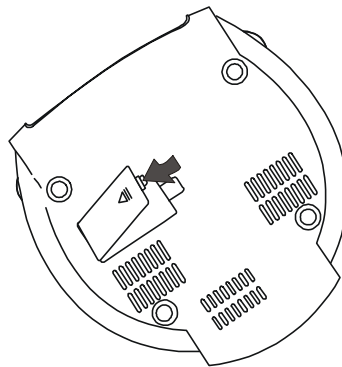

- 2.) Connect the battery to the battery terminal.

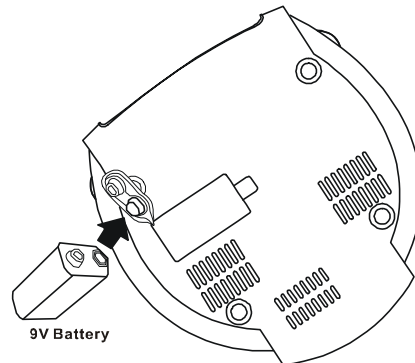

- 3.) Push the battery back into the compartment and replace the battery door.

If the power is interrupted the clock display will go off but the battery will maintain the clock and alarm time settings. When power is restored the time display will be correct and your alarm setting will also be maintained.

If you notice that the time display is completely wrong you probably experienced a power failure with a weak or exhausted battery in the compartment. Reset the clock and replace the battery as soon as possible.

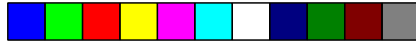

# LOCATION OF CONTROLS AND INDICATORS

## Front Panel

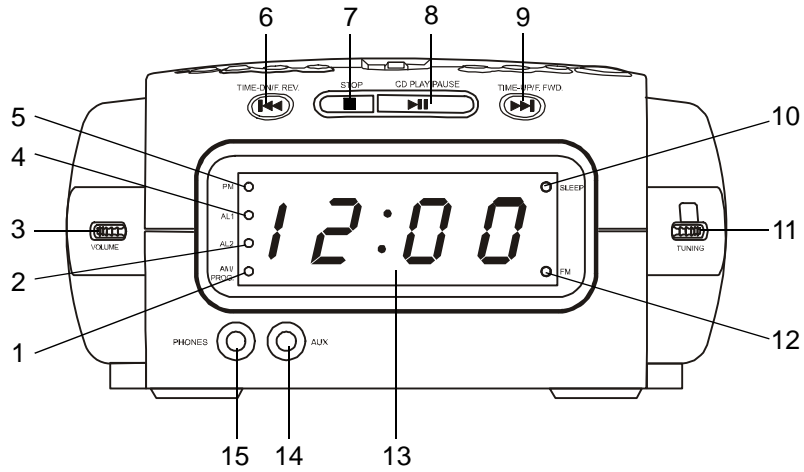

## Top Panel

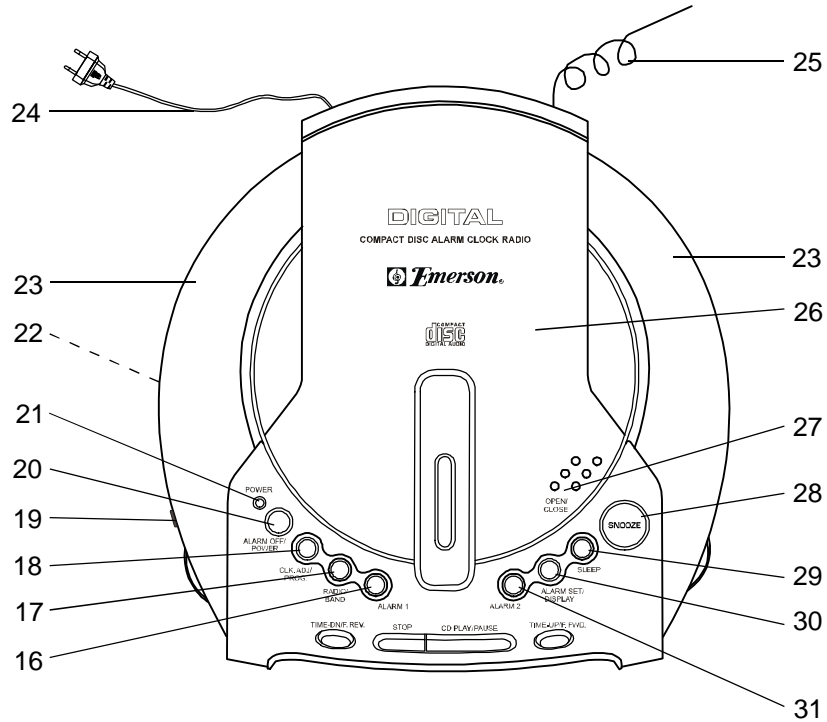



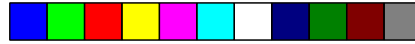

- 1.) **AM/PROG.** (AM Radio 'On' or CD Program Track) Indicator.
- 2.) **AL2** (Alarm 2) 'On' Indicator.
- 3.) **VOLUME** Control.
- 4.) **AL1** (Alarm 1) 'On' Indicator.
- 5.) **PM** Indicator.
- 6.) **⏮ TIME-DN/F.REV** Button.
- 7.) **■ STOP** Button.
- 8.) **⏸ CD PLAY/PAUSE** Button.
- 9.) **⏭ TIME-UP/F.FWD** Button.
- 10.) **SLEEP** Indicator.
- 11.) **TUNING** Control.
- 12.) **FM** Radio 'On' Indicator.
- 13.) LED Display.
- 14.) **AUX** Jack.
- 15.) **PHONES** Jack.
- 16.) **ALARM 1** Button.
- 17.) **RADIO/BAND** Button.
- 18.) **CLK.ADJ/PROG.** Button.
- 19.) **DIMMER (HIGH/LOW)** Selector Switch.
- 20.) **ALARM OFF/POWER** Button.
- 21.) **POWER** 'On' LED Indicator.
- 22.) Back Up Battery Compartment (At bottom cabinet)
- 23.) Speakers.
- 24.) AC Power Cord.
- 25.) FM Wire Antenna.
- 26.) CD compartment.
- 27.) CD Door **OPEN/CLOSE** Position.
- 28.) **SNOOZE** Button.
- 29.) **SLEEP** Button.
- 30.) **ALARM SET/DISPLAY** Button.
- 31.) **ALARM 2** Button.

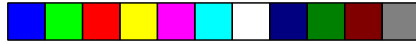

## OPERATING INSTRUCTIONS

### Setting The Correct Time And Day

**NOTE:** Connect the power cord to your AC outlet. Make sure to use an outlet that is always 'live'. Do not use an outlet that is controlled by a wall switch.

- 1.) When the unit is plugged in for the first time, the clock display will begin flashing "12:00" (AM).



- 2.) Depress and hold the **CLK.ADJ/PROG.** button for at least two seconds until only the Hour digits continue to flash.



- 3.) While the Hour digits are flashing press the **◀** or **▶** buttons repeatedly to set the clock to the correct Hour. Be sure to observe the **PM** indicator to set the hour correctly.



If the **PM** indicator is 'On' the hour displayed is PM.

- 4.) When the correct hour is flashing, press the **CLK.ADJ/PROG.** button again. The Minute digits begin flashing.



- 5.) While the Minute digits are flashing press the **◀** or **▶** buttons repeatedly to set the clock to the correct Minutes.



- 6.) Press the **CLK.ADJ/PROG.** button. The Day indicator "d:1" begins to flash.

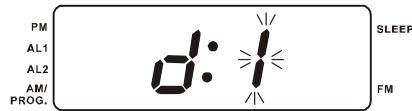

- 7.) While the day indicator is flashing, press the **◀** or **▶** buttons repeatedly to set the display to the correct 'Day'.



(1 = Monday, 2 = Tuesday, etc.)



8.) When the correct 'day' (digit) appears on the display press the **CLK.ADJ/PROG.** button once more to exit the clock-setting mode.

The display stops flashing and returns to the correct time and the clock begins to run.



**IMPORTANT:** After you press the **CLK.ADJ/PROG.** button you must make your time adjustments within 10 seconds while the display is flashing. After 10 seconds the display stops flashing and no time adjustments can be made. If this occurs you must begin with Step 2 above and start the time adjustment process again.

**NOTE:** After the Clock is set, pressing the **ALARM SET/DISPLAY** Button repeatedly will display the Alarm 1, Alarm 2, Week Day, Correct Time in sequence.





## Listening To The Radio

- 1.) Press the **ALARM OFF/POWER** button on the top panel to turn the unit 'On'. The **POWER** LED indicator comes on.
- 2.) Press the **RADIO/BAND** button to select the Radio function. Either the **AM/PROG** or the **FM** indicator will come on to confirm which band is selected. Press the **RADIO/BAND** button again to repeatedly switch between the **AM** and **FM** bands.
- 3.) Rotate the **TUNING** control on the right side panel to tune to the desired station.
- 4.) Rotate the **VOLUME** control on the left side panel to adjust the volume level.
- 5.) When you are finished listening press the **ALARM OFF/POWER** button to turn the unit 'Off'. The **POWER** LED indicator goes off.

## Antenna Information

### AM

The AM ferrite bar antenna is inside the cabinet. If AM reception is unsatisfactory try turning the entire unit slightly until you find the direction that provides the best reception for the desired station.

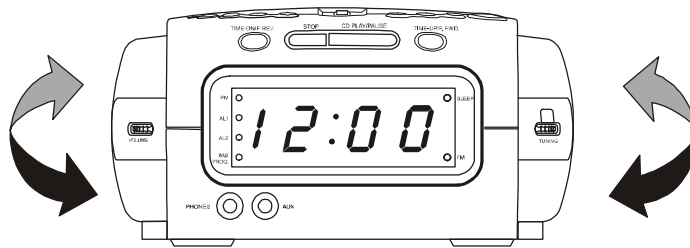

### FM

Make sure the FM lead wire antenna is extended to its full length. You may have to vary the direction of the wire antenna to find the position that provides the best reception.

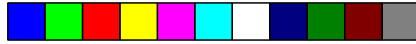

## Playing Compact Discs

**NOTE:** Although this CD player can read CD-R and CD-RW discs, in addition to normal CDs, however the playability of CD-R/RW discs may be affected by the type of software that was used to create the discs, as well as the quality and condition of the blank media you are using. 100% playability cannot be guaranteed. This is not an indication of a problem with the player.

### Normal Playback

- 1.) Press the **ALARM OFF/POWER** button to switch the unit 'On'. The **POWER** LED indicator comes 'On'.
- 2.) Press the **▶|| CD PLAY/PAUSE** button to enter CD playing mode.
- 3.) Press on the CD door in the area marked **OPEN/CLOSE** to open the door. If you have not already done so, remove the 'dummy CD' transit protection card from the CD player and discard it
- 4.) Place your disc on the center spindle with the printed label side facing up. Press down near the center of the disc to make sure it is firmly 'seated' on the spindle, press **OPEN/CLOSE** area to close the CD door.

- 5.) Two dashes "cd --" flash while the player reads the table of contents of the disc.

The display will show the total number of tracks for a few seconds and then return to the correct time.

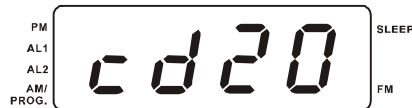
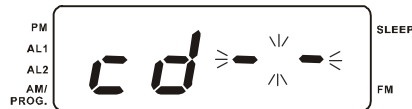

To see the track number at any time during playback press the **ALARM SET/ DISPLAY** button. The track number will appear for several seconds and then the display returns to the correct time.

**NOTE:** If the disc is inserted incorrectly, or if the disc is badly scratched and cannot be read by the player, "cd00" will appear on the display for a few seconds, and then the display returns to the correct time.





6.) Press the **▶|| CD PLAY/PAUSE** button to begin playback.

The display will briefly show "cd: 1"  
(Track 1) and playback on track 1 begins.



After a few seconds the display returns to the correct time.

7.) To Pause briefly during playback press the **▶|| CD PLAY/PAUSE** button.

The two dots " : " flash and after a few seconds the display returns to correct time. The sound stops, but the disc continues to spin.



Press **▶|| CD PLAY/PAUSE** button again to cancel pause and resume playback.

8.) To skip forward or backward to other tracks repeatedly press the **▶▶** or **◀◀** buttons until the desired track number appears in the display. Playback will begin on the selected track.

9.) To stop playback at any time press the **■ STOP** button. After the last track has played the disc stops automatically. Press the **OPEN/CLOSE** button to open the CD door and remove your disc.

**IMPORTANT NOTE:**

*You cannot stop CD playback by pressing the **ALARM OFF/POWER** button. You must press the **CD ■ STOP** button to stop CD playback first, and then you can press the **ALARM OFF/POWER** button to shut the power off.*



## To Start Playback From A Specific Track

Load your disc and wait until the display shows the total number of tracks.

Press the **▶▶** or **◀◀** buttons to select the desired track.

While the track number is still appearing press the **▶|| CD PLAY/PAUSE** button. Playback will begin on the selected track and continue until the end of the disc.



## High Speed Music Search

You can search rapidly forward or backward within a track to locate a specific musical passage.

Depress and hold the **▶▶** or **◀◀** buttons to begin high speed search.

The display will show the current track and the player moves rapidly forward or backward.

When you reach the desired passage release the **▶▶** or **◀◀** button and normal playback resumes.

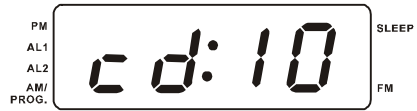

**NOTE:** The volume level is automatically reduced during high speed music search.

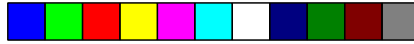

## Programmed Playback

The CD player in this unit has a **20** track programmable memory which allows you to program any disc to play just the tracks you want to hear in the exact order that you want to hear them. You may program a track or tracks to play more than once if desired.

**NOTE:** Programming can only be done while the player is in the Stop mode. If a disc is playing press the **■ STOP** button to stop playback before performing the programming steps below.

- 1.) Turn the unit 'On', press the **▶▶ CD PLAY/PAUSE** button to select **CD** function and load the desired disc in the player. Wait until the player reads the disc and the display shows the total track number.



- 2.) Press the **CLK.ADJ/PROG.** button.  
The **AM/PROG.** indicator and the Program Number "**0 1**" flash in the display, indicating that you can select the first track to be programmed.



- 3.) Press the **▶▶** or **◀◀** buttons to select the first track. The desired track number appears on the display.



Example: Track "7".

- 4.) Press the **CLK.ADJ/PROG.** button again.  
The selected track is entered in Program memory number 01 and the display advances to "**0 2**" indicating that you can select the next track to be programmed.



- 5.) Repeat Steps 3 and 4 to program up to 20 tracks in the memory.





6.) After you have programmed all the desired tracks press the **▶|| CD PLAY/ PAUSE** button to begin programmed playback. The **AM/PROG.** indicator stops flashing and remains 'On'. Playback will begin on the first track you programmed and continue until all programmed tracks have been played.

As each programmed track starts playing the display will briefly show the track number being played and then return to the correct time.

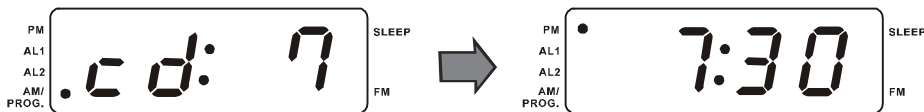

**NOTES:**

- After all programmed tracks have played the player stops but the program remains in the memory.

Press the **CLK.ADJ/PROG.** button and then the **▶|| CD PLAY/PAUSE** button to begin programmed playback again.

- To clear the program from the memory after the disc stops, press the **CLK.ADJ/PROG.** button and then press the **■ STOP** button.

Opening the CD door, pressing the **ALARM OFF/POWER** button to shut the unit 'Off', or switching to the Radio function also clears the program.

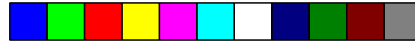

## Adjusting the Wake-up Times

This clock radio has two separate wake-up alarms that can be set and used independently. To set or adjust the wake-up times please proceed as follows:

- 1.) Depress and hold the **ALARM SET/ DISPLAY** button for at least two seconds until just the Hour digits and the **AL1** (Alarm 1) indicator are flashing.



- 2.) While the **AL1** Hour digits are flashing press the **▶▶** or **◀◀** buttons repeatedly to set the display to the correct wake-up hour.

Example: **7:00 AM**



Observe the **PM** indicator to make sure you have set the wake-up hour correctly. If the **PM** indicator is 'On' the wake-up time displayed is "PM". If the **PM** indicator is 'Off' the wake-up time displayed is "AM".

- 3.) When the correct wake-up hour is flashing press the **CLK. ADJ/PROG.** button again.



The Hour digits stop flashing and the minute digits begin to flash.

- 4.) While the Minute digits are flashing press the **▶▶** or **◀◀** buttons repeatedly to set the display to the correct wake-up minute.

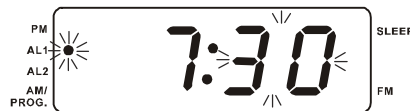

- 5.) When the desired Alarm 1 wake-up time is showing on the display, press the **CLK. ADJ/PROG.** button to store the Alarm 1 wake-up time in the timer memory.

The **AL2** (Alarm 2) indicator and the Alarm 2 Hour digits begin flashing.



**NOTE:** If you do not need to adjust the Alarm 2 wake up time you may just wait 10 seconds. After 10 seconds the Alarm 2 display stops flashing and the clock returns to the correct time.

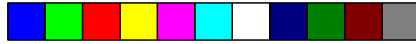

- 6.) While the Alarm 2 Hour digits are flashing press the ►► or ◀◀ buttons repeatedly to set the display to the correct wake-up hour.

Example: **9:00 AM**



Observe the **PM** indicator to make sure you have set the wake-up hour correctly. If the **PM** indicator is 'On' the wake-up time displayed is "PM". If the **PM** indicator is 'Off' the wake-up time displayed is "AM".

- 7.) When the correct wake-up hour is flashing press the **CLK. ADJ/PROG.** button again.



The Hour digits stop flashing and the minute digits begin to flash.

- 8.) While the Minute digits are flashing press the ►► or ◀◀ buttons repeatedly to set the display to the correct wake-up minute.



- 9.) When the desired Alarm 2 wake-up time is showing on the display, press the **CLK. ADJ/PROG.** button to store the Alarm 2 wake-up time in the timer memory.

The display stops flashing and returns to the correct time. The Alarm 2 indicator disappears.



**IMPORTANT:** After you press the **CLK. ADJ/PROG.** button you must make your wake-up time adjustments within 10 seconds while the wake-up time display is flashing. After 10 seconds the wake-up time display stops flashing, the display returns to the correct time, and no wake-up time adjustments can be made. If this occurs you must begin with Step 1 above and start the wake-up time adjustment process again.



## Setting The Alarms / Selecting The Wake-up Mode

After you have adjusted the wake-up times on one or both alarms you must press the respective **ALARM 1** and/or **ALARM 2** buttons one, two or three times, to activate the alarms and select the wake-up mode.

The color of the **AL1** and **AL2** indicators will change according to the wake-up mode that you select - Buzzer, Radio, or CD.

- Press the **ALARM 1** or **ALARM 2** button **once**.

The **AL** indicator is **Red**. This indicates the **Wake To Buzzer** mode is selected and the alarm is 'On'.

- Press the **ALARM 1** or **ALARM 2** button **twice**.

The **AL** indicator is **Green**. This indicates the **Wake To Radio** mode is selected and the alarm is 'On'.

- Press the **ALARM 1** or **ALARM 2** button **three times**.

The **AL** indicator is **Yellow**. This indicates the **Wake To CD** mode is selected and the alarm is 'On'.

- Press the **ALARM 1** or **ALARM 2** button a **fourth time** and the **AL1** or **AL2** indicators disappear. This indicates that the alarms are canceled.

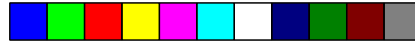

## Wake To Buzzer

- 1.) Check the wake-up time settings for Alarm 1, Alarm 2, or both alarms and adjust the wake up times if necessary.
- 2.) Press the **ALARM 1** and/or **ALARM 2** buttons once. The **AL1** and/or **AL2** indicators appear Red.
- 3.) At the selected wake up times the buzzer will turn on. It will continue for one hour and then stop automatically and reset itself for the following day.
- 4.) To stop the buzzer immediately, press the **ALARM OFF/POWER** button.

## Wake To Radio

- 1.) Check the wake-up time settings for Alarm 1, Alarm 2, or both alarms and adjust the wake up times if necessary.
- 2.) Turn the Radio 'On', tune to the desired station and set the **VOLUME** control to the desired level to wake you up, then turn the radio 'Off' again.
- 3.) Press the **ALARM 1** and/or **ALARM 2** buttons twice. The **AL1** and/or **AL2** indicators appear Green.
- 4.) At the selected wake up times the Radio will turn on. It will continue for one hour and then stop automatically and reset itself for the following day.
- 5.) To stop the Radio immediately, press the **ALARM OFF/POWER** button.



## Wake To CD

- 1.) Check the wake-up time settings for Alarm 1, Alarm 2, or both alarms and adjust the wake up times if necessary.
- 2.) Insert the desired CD in the CD player, start playback and adjust the **VOLUME** to the desired level. Then press the **■ STOP** button to stop the disc and the **ALARM OFF/POWER** button to shut the power 'Off'.
- 3.) Press the **ALARM 1** and/or **ALARM 2** buttons three times. The **AL1** and/or **AL2** indicators appear Yellow.
- 4.) At the selected wake up times the CD player will turn on. It will play for one hour, or until the end of the disc, whichever comes first, and then stop automatically and reset itself for the following day.
- 5.) To stop the CD player immediately, press the **ALARM OFF/POWER** button.

**NOTE:** *If there's no CD inserted, or the CD is damaged, it will automatically change to Buzzer.*



## Canceling The Alarms

To cancel the alarms completely press the respective **ALARM 1** and/or **ALARM 2** buttons until the **AL1** and/or **AL2** indicators disappear.

## Snooze/Repeat Alarm

After the alarm turns on in the morning you can press the **SNOOZE** button for a few extra minutes sleep. The alarm will stop for approximately 9 minutes and then come on again. Snooze operation can be repeated several times if desired, but after one hour the alarm will not turn 'On' again.

## Dimmer Control

The display **DIMMER** selector switch located on the left side cabinet was set to the **HIGH** position at our factory.

If you find the display to be too bright for sleeping, slide the **DIMMER** selector switch to the **LOW** position.



## Sleep To Music Timer

You can use the sleep timer to fall asleep to the Radio or CD player up to 90 minutes and have the unit shut off automatically.

- 1.) Press the **ALARM OFF/POWER** button to turn the power 'On'. Operate the Radio or CD player as usual. Adjust the **VOLUME** to the desired level. The level you select for "Sleep To Music" is the same level you will hear when the alarm turns 'On' in the morning.

- 2.) Press and hold the **SLEEP** button to select the desired amount of sleep timer from 90 minutes to one minute. The **SLEEP** indicator comes 'On'.



- 3.) When the display shows the desired amount of time, release the **SLEEP** button.

After 5 seconds the display changes back to the correct time.



The Radio or CD play will continue until the sleep timer counts down to "00" and then shut off automatically.

- 4.) To stop the Radio or CD player before the sleep timer counts down to "00", press the **ALARM OFF/STANDBY** button to turn the unit "Off".

**NOTE:** *If you are falling asleep to CD, the sound stops when the disc ends, even if a longer sleep time was selected.*





## Auxiliary Input Jack (Connection Cable Not Included)

This unit includes an **AUX** input jack to allow you to connect external devices, such as an iPod® or portable MP3 player, and listen to the music stored on your external device through the speakers of this radio.

Connect the headphone jack of your external device to the **AUX** input jack located on the front panel of this unit. The connection cable is not included.

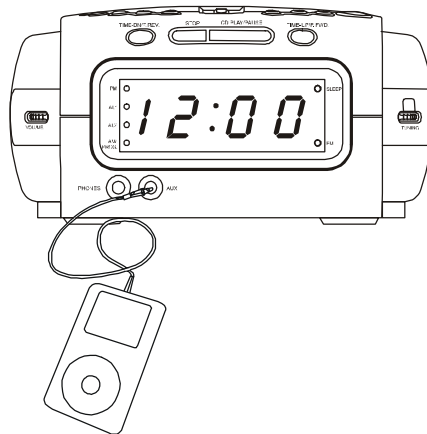

### **IMPORTANT:**

*When you connect a cable to the **AUX** input jack of this unit the 'function' selector automatically switches from Radio or CD to Auxiliary Input. You must disconnect the cable from the **AUX** input jack in order to listen to the Radio or CD again.*

*After connecting your external device to the **AUX** input jack, slowly adjust both the volume controls on this unit and your external device to find the desired setting. Please note that if the **VOLUME** control on this radio is set to a low level while the **VOLUME** control on your external device is set too high, the sound will be distorted.*

*Remember to disconnect the connection cable after use in order to be able to listen to the Radio or CD player again.*

**NOTE:** *If an external audio source is connected to the **AUX** (Auxiliary Input) jack at the wake-up time the alarm will automatically default to the Buzzer mode, regardless of the mode you selected.*

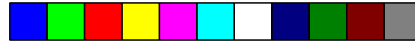

## Headphone (PHONES) Jack

This unit includes a 3.5mm **PHONES** (headphone) jack on the front panel. This allows you to connect a set of stereo headphones (not included) for private listening without disturbing others. When headphones are connected the built-in speakers are automatically disconnected.

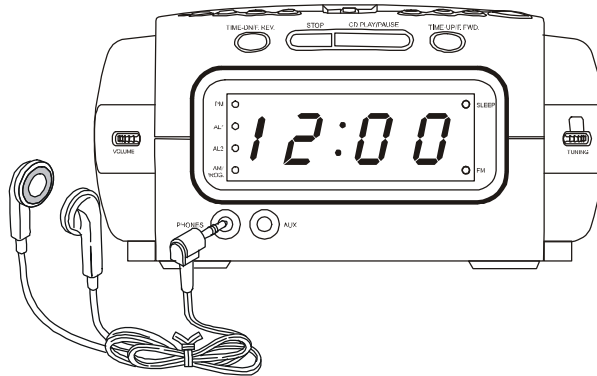

**IMPORTANT!** When using stereo headphones always set the volume control to a low level before you put on the headphones. Then put on the headphones and gradually adjust the volume control to the desired level.

Remember that prolonged listening with headphones or ear buds at high volume levels may eventually cause hearing loss.

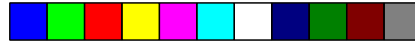

## CARE AND MAINTENANCE

### Compact Disc Care

- To remove a disc from its storage case, press down on the center of the case and lift the disc out, holding it carefully by the edges.

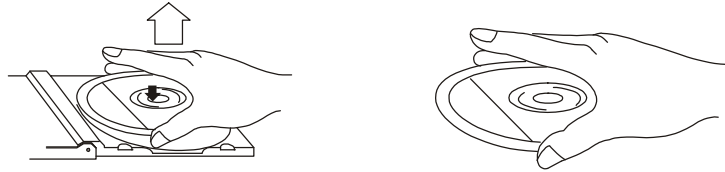

- Fingerprints and dust should be carefully wiped off the disc's recorded surface with a soft cloth. Unlike conventional records, compact discs have no grooves to collect dust and microscopic debris, so gently wiping with a soft cloth should remove most particles. Wipe in a straight line from the inside to the outside of the disc. Small dust particles and light stains will have absolutely no effect on reproduction quality.

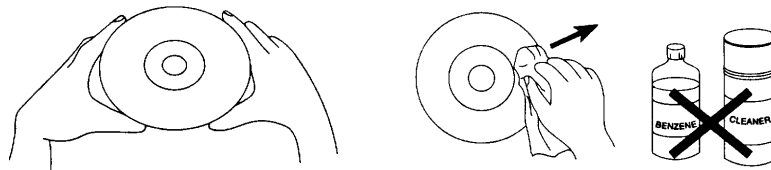

- Clean the disc periodically with a soft, lint-free, dry cloth. Never use detergents or abrasive cleaners to clean the disc. If necessary, use a CD cleaning kit.
- Never write on or affix labels to the surface of compact discs.

### Care Of The Cabinet

- If the cabinet becomes dusty wipe it with a soft dry dust cloth. Do not use any wax or polish sprays on the cabinet.
- If the front panel becomes dirty or smudged with fingerprints it may be cleaned with a soft cloth slightly dampened with a mild soap and water solution. Never use abrasive cloths or polishes as these will mar the finish of your unit.

### Caution

Never allow any water or other liquids to get inside the unit while cleaning.

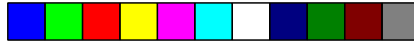

## TROUBLESHOOTING GUIDE

Should this unit exhibit a problem, check the following before seeking service.

Symptom	Possible Cause	Solution
<b>Radio</b>		
Noise or sound distorted on AM or FM broadcasts.	Station not tuned properly for AM or FM.	Retune the AM or FM broadcast station.
	<b>FM:</b> FM Wire antenna is not extended.	Extend FM Wire antenna.
	<b>AM:</b> The bar antenna is not positioned correctly.	Reposition the unit until best reception is obtained.
AM or FM, no sound.	Volume at minimum.	Increase Volume.
<b>Compact Disc Player</b>		
CD Player will not play.	CD is not installed or installed incorrectly.	Insert CD with label side up.
CD skips while playing.	Disc is dirty or scratched.	Wipe disc with cloth or use another disc.
CD does not shut off when pressing the ALARM OFF/POWER button during playback.	This is normal operation.	You must always press the ■ STOP button to stop CD playback, then press the ALARM OFF/POWER button.



TO FIND THE LOCATION AND PHONE NUMBER OF YOUR NEAREST SERVICE CENTER PERMITTED TO PERFORM WARRANTY...

CALL TOLL FREE: 1-800-695-0098

FOR ADDITIONAL SET-UP OR OPERATING ASSISTANCE  
PLEASE CALL:  
1-800-898-9020

FOR CUSTOMER SERVICE, PLEASE WRITE TO:  
Emerson Radio Corp.,  
Consumer Affairs Dept.,  
5101 Statesman Drive,  
Irving, TX 75063.



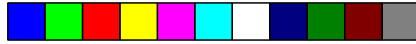

**LIMITED WARRANTY**

Emerson Radio Corp. warrants manufacturing defects in original material, including original parts and workmanship, under normal use and conditions, for a period of ninety (90) days from the date of original purchase in the U.S. With your dated proof of purchase, we will provide repair service at no charge for labor and parts at an authorized Depot Repair Facility, or replace the product in our discretion. For repair or replacement, pack your unit in a padded box, enclose your check or money order payable to Emerson Radio Corp. in the amount of \$9.00 (not required by California residents) to cover shipping and handling costs, and enclose a copy of your proof of purchase. Send your unit to:

Emerson Radio Corp.,  
5101 Statesman Drive,  
Irving, TX 75063.

This warranty does not cover damage from negligence, misuse, abuse, accident, failure to follow operating instructions, commercial use, rental, repairs by an unauthorized facility, or products purchased, used, serviced or damaged outside of the United States.

**THIS WARRANTY GIVES YOU SPECIFIC LEGAL RIGHTS, AND YOU MAY ALSO HAVE OTHER RIGHTS WHICH VARY FROM STATE TO STATE.**

**AU898M**

The Serial Number of your unit is located on a label on the bottom cabinet.

Please take a moment to locate the Serial Number of your unit and write it in the space provided below. You may be asked to provide this number when calling to request customer service.

Model No: **CKD1100/CKD1100BL/CKD1100GN/CKD1100PK**

Serial Number: \_\_\_\_\_





CKD1100-052107-03

Printed in China



## Free Manuals Download Website

<http://myh66.com>

<http://usermanuals.us>

<http://www.somanuals.com>

<http://www.4manuals.cc>

<http://www.manual-lib.com>

<http://www.404manual.com>

<http://www.luxmanual.com>

<http://aubethermostatmanual.com>

Golf course search by state

<http://golfingnear.com>

Email search by domain

<http://emailbydomain.com>

Auto manuals search

<http://auto.somanuals.com>

TV manuals search

<http://tv.somanuals.com>