



***Emerson***<sup>®</sup>

***Stereo Radio, CD-R/RW Player  
with Dual Alarm Clock***



***OWNER'S MANUAL***

***CKD9906***



Visit our web site at [www.emersonradio.com](http://www.emersonradio.com)





## CAUTION

TO PREVENT FIRE OR SHOCK HAZARD, DO NOT USE THIS PLUG WITH AN EXTENSION CORD, RECEPTACLE OR OTHER OUTLET UNLESS THE BLADES CAN BE FULLY INSERTED TO PREVENT BLADE EXPOSURE. TO PREVENT FIRE OR SHOCK HAZARD, DO NOT EXPOSE THIS APPLIANCE TO RAIN OR MOISTURE.

 <p>The lightning flash with arrow-head symbol, within an equilateral triangle is intended to alert the user to the presence of uninsulated 'dangerous voltage' within the product's enclosure that may be of sufficient magnitude to constitute a risk of electric shock to persons.</p>	<p style="text-align: center;"><b>CAUTION</b> RISK OF ELECTRIC SHOCK DO NOT OPEN</p> <p><b>WARNING: TO REDUCE THE RISK OF ELECTRIC SHOCK DO NOT REMOVE COVER (OR BACK), NO USER SERVICEABLE PARTS INSIDE REFER SERVICING TO QUALIFIED SERVICE PERSONNEL.</b></p>	 <p>The exclamation point within an equilateral triangle is intended to alert the user to the presence of important operating and maintenance (servicing) instructions in the literature accompanying the appliance.</p>
--	--	---

The Caution Marking was located at the bottom enclosure of the apparatus.

## IMPORTANT SAFETY INSTRUCTIONS

- 1.) Read these instructions.
- 2.) Keep these instructions.
- 3.) Heed all warnings.
- 4.) Follow all instructions.
- 5.) Do not use this apparatus near water.
- 6.) Clean only with dry cloth.
- 7.) Do not block any ventilation openings. Install in accordance with the manufacturer's instructions.
- 8.) Do not install near any heat sources such as radiators, heat registers, stoves, or other apparatus (including amplifiers) that produce heat.
- 9.) Do not defeat the safety purpose of the polarized or grounding-type plug. A polarized plug has two blades with one wider than the other. A grounding type plug has two blades and a third grounding prong. The wide blade or the third prong is provided for your safety. If the provided plug does not fit into your outlet, consult an electrician for replacement of the obsolete outlet.
- 10.) Protect the power cord from being walked on or pinched particularly at plugs, convenience receptacles, and the point where they exit from the apparatus.
- 11.) Only use attachments / accessories specified by the manufacturer.
- 12.) Unplug this apparatus during lightning storms or when unused for long periods of time.
- 13.) Refer all servicing to qualified service personnel. Servicing is required when the apparatus has been damaged in any way, such as power-supply cord or plug is damaged, liquid has been spilled or objects have fallen into the apparatus, the apparatus has been exposed to rain or moisture, does not operate normally, or has been dropped.
- 14.) This appliance shall not be exposed to dripping or splashing water and no object filled with liquids such as vases shall be placed on the apparatus.
- 15.) Do not overload wall outlet. Use only power source as indicated.
- 16.) Use replacement parts as specified by the manufacturer.
- 17.) The product may be mounted to a wall only if recommended by the manufacturer.
- 18.) Upon completion of any service or repairs to this product, ask the service technician to perform safety checks.



## Before We Begin

Thank you for purchasing this Emerson audio product. The Emerson brand is your assurance of quality, performance and value.

Our engineers have included many useful and convenient features in this product. Please be sure to read this owner's manual completely to make sure you are getting the maximum benefit from each feature.

This product was manufactured using the highest quality components and standards of workmanship. It was tested by Emerson inspectors and found to be in perfect working order before it left our factory. However, there is always the chance that some problem may occur because of rough handling during shipment to the retail store or to the final consumer.

If, after reading this manual, you experience any problems with the operation of this product, please refer to the instructions for obtaining service at the end of this manual. Emerson and Emerson retailers are committed to your satisfaction.

Once again, thanks for purchasing this Emerson audio product.



## IMPORTANT NOTES

- Avoid installing this unit in places exposed to direct sunlight or close to heat radiating appliances such as electric heaters, on top of other stereo equipment that radiates too much heat, places lacking ventilation or dusty areas, places subject to constant vibration and/or humid or moist areas.
- Operate controls and switches as described in the manual.
- Before turning 'On' the power, make certain that the power cord is properly installed. When moving the set, be sure to first disconnect the power cord.
- Store your CDs, in a cool area to avoid damage from heat.

### CLASS 1 LASER PRODUCT

CLASS 1 LASER PRODUCT  
APPAREIL À LASER DE CLASSE 1  
PRODUCTO LASER DE CLASE 1

CAUTION  
INVISIBLE LASER RADIATION  
WHEN OPEN AND INTERLOCKS  
DEFEATED.  
AVOID EXPOSURE TO BEAM



**This product contains a low power Laser Device.**

### FCC Information

This equipment has been tested and found to comply with the limits for a class B digital Device, pursuant to part 15 of the FCC Rules. These limits are designed to provide reasonable protection against harmful interference in a residential installation. This equipment generates, uses, and can radiate radio frequency energy and, if not installed and used in accordance with the instructions, may cause harmful interference to radio communications. However, there is no guarantee that interference will not occur in a particular installation. If this equipment does cause harmful interference to radio or television reception, which can be determined by turning the equipment off and on, the user is encouraged to try to correct the interference by one or more of the following measures:

- Reorient or relocate the receiving antenna.
- Increase the separation between the equipment and receiver.
- Connect the equipment into an outlet on a circuit different from that to which the receiver is connected.
- Consult the dealer or an experienced radio/TV technician for help.

This device complies with part 15 of the FCC Rules. Operation is subject to the following two conditions:

- (1) This device may not cause harmful interference, and
- (2) This device must accept any interference received, including interference that may cause undesired operation.

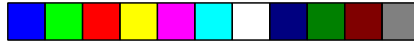

## PREPARATION FOR USE

### Unpacking And Set Up

- Remove the unit from the carton, and remove all packing materials from the unit.
- Save the carton and packing materials in case the unit ever needs to be returned for service. Using the original carton and packing materials is the only way to safely repack the unit for shipment.
- Remove any descriptive labels or stickers from the top or front of the unit. Do not remove any labels from the back or bottom of the cabinet.
- Remove any small strips of tape that may have been used to prevent the CD door from opening in transit.
- Press on the **OPEN/CLOSE** area on the CD door to open the CD door, and remove the dummy CD protection card from the CD compartment. Discard it and close the CD door.
- Unwind the FM wire antenna on the back cabinet and extend it to its full length.
- Unwind the AC power cord and extend it to its full length.
- Place the unit on a stable, level surface such as a table, desk, shelf, etc within easy reach of an AC outlet, out of direct sunlight, and away from sources of excessive heat, dust, moisture or humidity.

### Protect Your Furniture

This model is equipped with non-skid rubber 'feet' to prevent the product from moving when you operate the controls. These 'feet' are made from non-migrating rubber material specially formulated to avoid leaving any marks or stains on your furniture. However certain types of oil based furniture polishes, wood preservatives, or cleaning sprays may cause the rubber 'feet' to soften, and leave marks or a rubber residue on the furniture. To prevent any damage to your furniture we strongly recommend that you purchase small self-adhesive felt pads, available at hardware stores and home improvement centers everywhere, and apply these pads to the bottom of the rubber 'feet' before you place the product on fine wooden furniture.



## Power Source

This system is designed to operate on 120V AC 60Hz house current only. Connecting this system to any other power source may cause damage to the system and such damage is not covered by your warranty.

**Note:** *The system has polarized AC plug with one wide blade and one narrow blade. The plug will only fit into matching polarized AC outlets.*

This is a safety feature to reduce the possibility of electric shock. If the plug will not fit in your AC outlet, you probably have an outdated non-polarized outlet. You should have your outdated outlet changed by a qualified, licensed electrician.

Do not file the wide blade on the plug, or use an adapter to make the plug fit into your outlet. This defeats the safety feature and could expose you to electric shock.

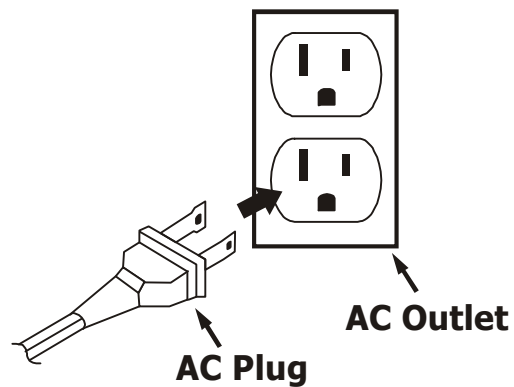



## Battery Back Up System

This unit uses a single **9-Volt** battery (not included) to maintain the time and alarm settings in the event that it is accidentally unplugged, or you experience a temporary power failure. We recommend that you install a well-known brand of Alkaline battery for longest life and best performance. To keep the battery back up system operational you should install a new battery every 6 to 9 months. Some people find it convenient to replace the back up batteries in their alarm clocks, clock radios, and smoke detectors too, at the beginning and end of Daylight Saving Time.

To install the back up battery, turn the unit upside down, and

- 1.) Press on the battery door “” mark and slide it in the direction of the “arrow” to open.
- 2.) Connect the battery to the battery terminal, push the battery back into the compartment and replace the battery door.

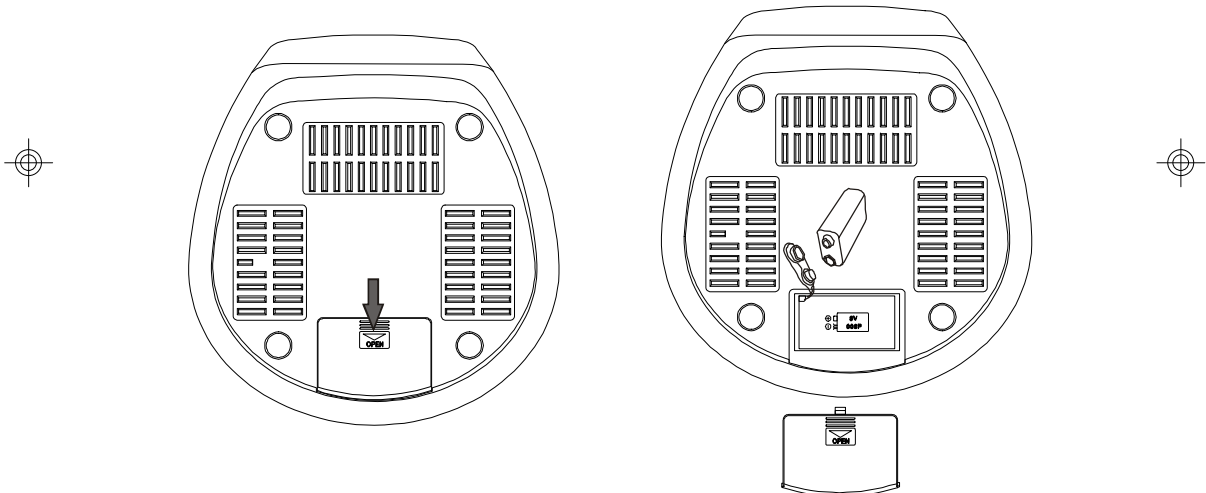

If the power is interrupted the clock display will go off but the battery will maintain the clock and alarm time settings. When power is restored the time display will be correct and your alarm setting will also be maintained.

If you notice that the time display is “flashing” you probably experienced a power failure with a weak or exhausted battery in the compartment. Reset the clock and replace the battery as soon as possible.



# LOCATION OF CONTROLS AND INDICATORS

## Top Panel

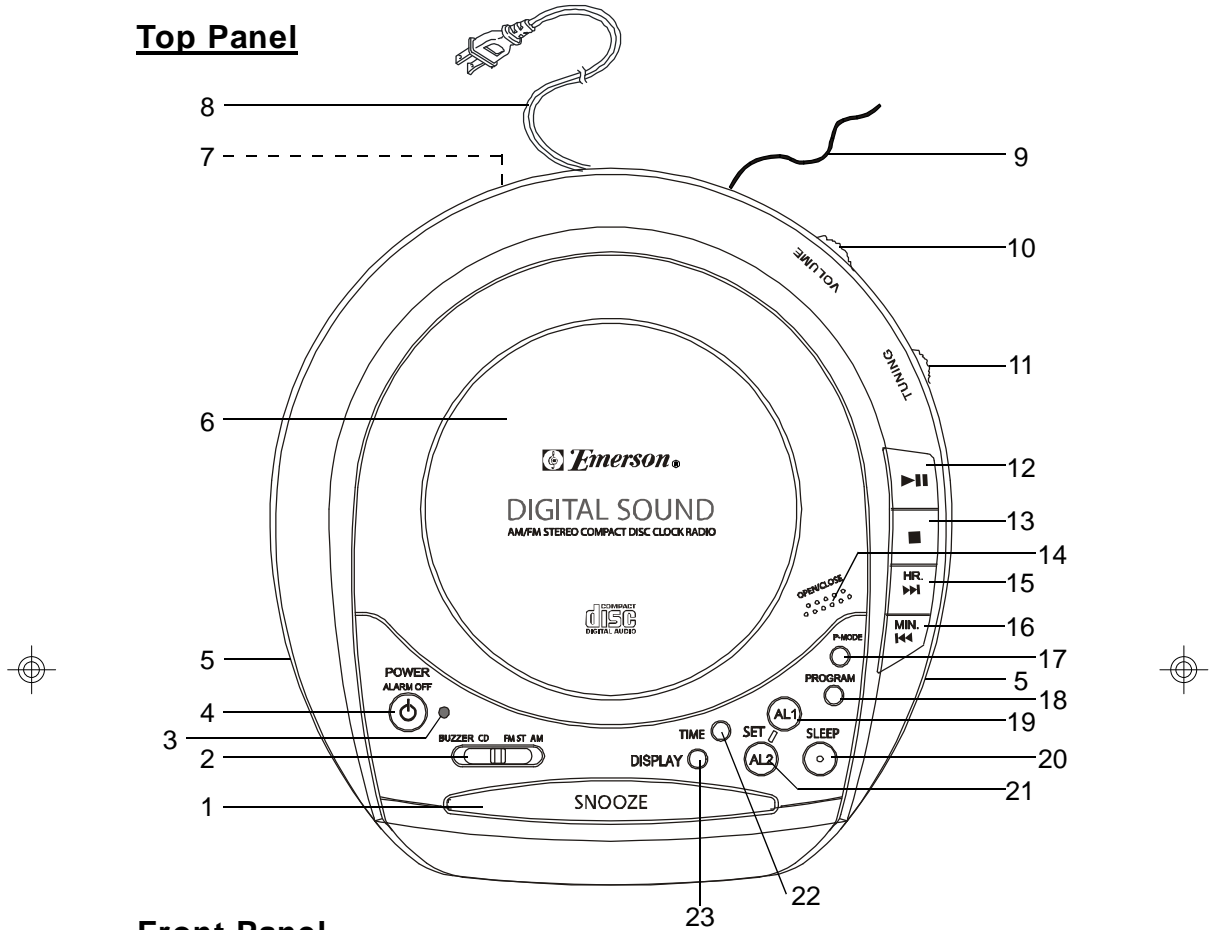



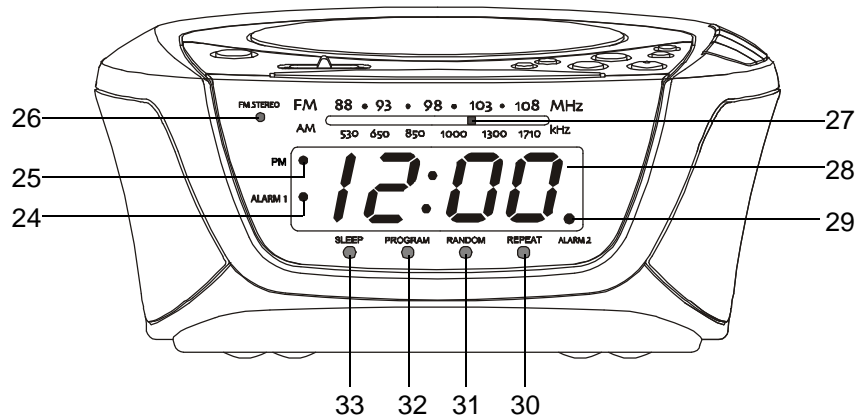

## Front Panel

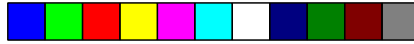





- 1.) **SNOOZE** Button.
- 2.) **BUZZER-CD-FM ST-AM** Selector Switch.
- 3.) Power 'On' Indicator.
- 4.)  **POWER**(On/Off)/**ALARM OFF** Button.
- 5.) Speakers.
- 6.) CD compartment.
- 8.) AC Power Cord.
- 7.) Back Up Battery Compartment (At bottom cabinet).
- 9.) FM Wire Antenna.
- 10.) **VOLUME** Control.
- 11.) **TUNING** Control.
- 12.)  Play/Pause Button.
- 13.)  Stop Button.
- 14.) CD Door **OPEN/CLOSE** Area.
- 15.)  Skip Search Forward/**HR.**(Hour) Button.
- 16.)  Skip Search Reverse/**MIN.**(Minute) Button.
- 17.) **P-MODE** Button.
- 18.) **PROGRAM** Button.
- 19.) **AL**(Alarm) **1 SET** Button.
- 20.) **SLEEP** Button.
- 21.) **AL**(Alarm) **2 SET** Button.
- 22.) **TIME** Button.
- 23.) **DISPLAY** Button.
- 24.) **ALARM 1** 'On' Indicator.
- 25.) **PM** Indicator.
- 26.) **FM STEREO** Indicator.
- 27.) Tuning Dial pointer.
- 28.) LED Display.
- 29.) **ALARM 2** 'On' Indicator.
- 30.) **REPEAT** Indicator.
- 31.) **RANDOM** Indicator.
- 32.) **PROGRAM** Indicator.
- 33.) **SLEEP** Indicator.



## OPERATING INSTRUCTIONS

### Setting The Time Of Day

- Connect the power cord to your AC outlet. Make sure to use an outlet that is always 'live'. Do not use an outlet that is controlled by a wall switch.
- When the unit is plugged in for the first time the display will show flashing "12:00" (AM).



- 1.) While the display is flashing, press the ►► **HR.** button to set the hour. Be sure to observe the **PM** indicator to set the hour correctly. If the **PM** indicator is 'On' the hour displayed is PM.
- 2.) Press ►► **MIN.** button to set the minute correctly.

- 3.) Press the **TIME** button once. The time is set.  
The display remains 'On'.



**Note:** You may proceed to re-set the time again by pressing the **TIME** button once during Power-off or CD, FM, AM, Buzzer modes.

### Important Notes !!

If you press and hold the **TIME** button any time, the clock will change to European 24-Hour format, and vice versa.

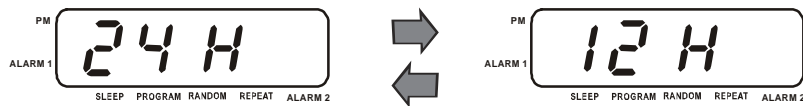



## Setting The Wake Up Times

The unit has two separate wake up alarms that can be set and used independently.

- 1.) Press the **AL 1** or **AL 2** button once. The display will change from the respective time of the day to wake up time and begin flashing.

The **ALARM 1** or **ALARM 2** indicator comes "On".

- 2.) Press the **▶▶ HR.** button to set the wake up hour. Set correctly for AM or **PM**.

- 3.) Press the **◀◀ MIN.** button to set the minute correctly.

Press the respective **AL** button once. The Alarm time is set.

The display returns to correct time.



**Note:** Press the **AL 1** or **AL 2** button once to turn the respective Alarm time 'Off'. The **ALARM 1** or **ALARM 2** indicator will go 'Off'.



## Listening To The Radio

- 1.) Press the **POWER/ALARM OFF** Button to turn the unit 'On'. The Power indicator comes 'On'.
- 2.) Set the **BUZZER-CD-FM ST-AM** selector to **FM ST** or **AM** position.
- 3.) Turn the **TUNING** control to find the desired station.

If you slide the selector to **FM ST** position, and tune to a FM Stereo station, the **FM STEREO** indicator light comes 'On'.



- 4.) Adjust the **VOLUME** control to the desired level.
- 5.) When you are finished listening press the **POWER/ALARM OFF** button to turn the unit 'Off'. The Power indicator goes 'Off'.



## Antenna Information

### AM

The AM ferrite bar antenna is inside the cabinet. If AM reception is unsatisfactory try turning the entire unit slightly until you find the direction that provides the best reception for the desired station.

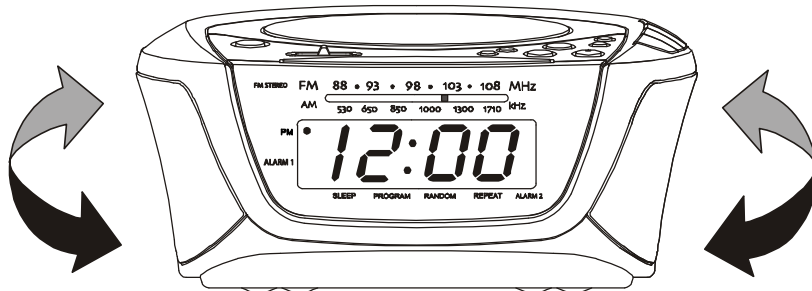

### FM

Make sure the FM lead wire antenna is extended to its full length. You may have to vary the direction of the wire antenna to find the position that provides the best reception.

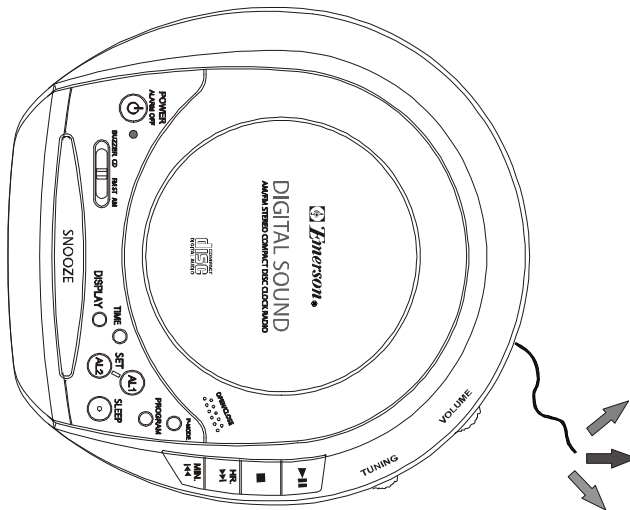



## Playing Compact Discs

**Note:** Although this CD player can read CD-R and CD-RW discs, in addition to normal CDs, however the playability of CD-R/RW discs may be affected by the type of software that was used to create the discs, as well as the quality and condition of the blank media you are using. 100% playability cannot be guaranteed. This is not an indication of a problem with the player.

### Normal Playback

- 1.) Press the **POWER/ALARM OFF** button to turn the unit 'On'. The Power indicator comes 'On'.
- 2.) Set the **BUZZER-CD-FM ST-AM** selector to the **CD** position.
- 3.) Press on the **OPEN/CLOSE** position on CD door to open the CD door.
- 4.) Place your disc on the center spindle with the printed label side facing up. Close the CD door.

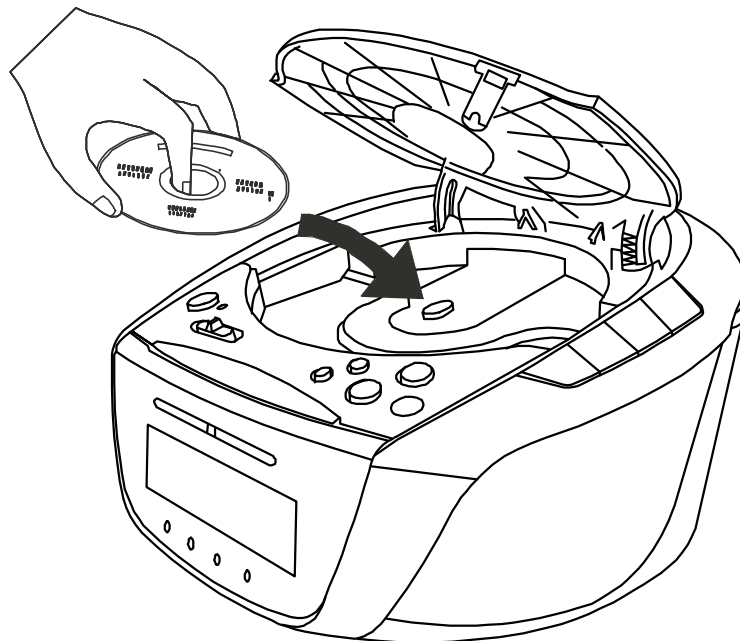



- 5.) Two dashes “--” flash while the player reads the table of contents of the disc. The display will show the total number of tracks for a few seconds and then return to the correct time.

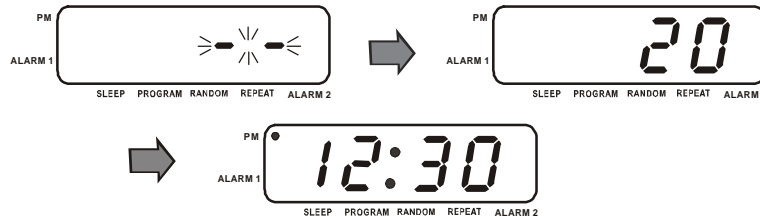

**Note:** If the disc is inserted incorrectly, or if the disc is badly scratched and cannot be read by the player, “no” will appear on the display for a few seconds, and then the display returns to the correct time.



- 6.) Press the ►|| button to begin playback. The display will briefly show “01” (Track 01) and playback on track 01 begins. After a few seconds the display returns to the correct time.



Press the **DISPLAY** button to return to Track number again for few seconds.

- 7.) To Pause briefly during playback press the ►|| button. The track number flashes briefly and the sound stops, but the disc continues to spin.

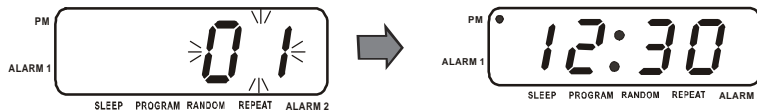

Press ►|| button again to cancel pause and resume playback.

- 8.) To skip forward or backward to other tracks repeatedly press the ►|| or ◀◀ buttons until the desired track number appears in the display. Playback will begin on the selected track.
- 9.) To stop playback at any time press the ■ Stop button. After the last track has played the disc stops automatically. Open the CD door and remove your disc.



## To Start Playback From A Specific Track

Load your disc and wait until the display shows the total number of tracks.

Press the ►► or ◀◀ buttons to select the desired track.

While the track number is still flashing press the ►► button.



Playback will begin on the selected track and continue until the end of the disc.

## High Speed Music Search

You can search rapidly forward or backward within a track to locate a specific musical passage.

Depress and hold the ►► or ◀◀ buttons to begin high speed search. The display will show the current track and the player moves rapidly forward or backward. When you reach the desired passage release the ►► or ◀◀ button and normal playback resumes.

**Note:** *The volume level is automatically reduced during high speed music search.*

## Random Playback

To listen to the tracks on a disc in random order:

1.) Load your disc and wait until the total track number is displayed.

2.) Press the **P-MODE** button three times.

The **RANDOM** indicator comes 'On'.



3.) Press the ►► button. The player will select a track at random and playback begins on that track. The selected track number appears in the display for a few seconds.

After each track has played once the player stops automatically.

To cancel random playback at any time, press the **P-MODE** button until **RANDOM** indicator goes 'Off'.



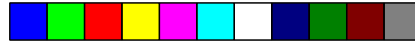

## Repeat Playback

You can program the player to repeat a single track or the entire disc continuously.

### One Track Repeat

1.) Load your disc and wait until the total track number is displayed.

2.) Press the **P-MODE** button once.

The **REPEAT** indicator flashes.



3.) Press **▶▶** or **◀◀** button to select the track to be repeated.

When the track number is still flashing, press the **▶▶** button. The selected track will be repeated continuously.



### All Tracks Repeat

1.) Load your disc and wait until the total track number is displayed.

2.) Press the **P-MODE** button twice.

The **REPEAT** indicator remains 'On'.



3.) Press the **▶▶** button. All tracks will be repeated continuously.

To cancel repeat playback press the **P-MODE** button until the **REPEAT** indicator goes 'Off', or press the **■** Stop button.



## Programmed Playback

The CD player in this unit has a **20** track programmable memory which allows you to program any disc to play just the tracks you want to hear in the exact order that you want to hear them. You may program a track or tracks to play more than once if desired.

**Note:** Programming can only be done while the player is in the Stop mode. If a disc is playing press the ■ Stop button to stop playback before performing the programming steps below.

- 1.) Turn the unit 'On', select the **CD** function and load the desired disc in the player. Wait until the player reads the disc and the display shows the total track number.
- 2.) Press the **PROGRAM** button. The **PROGRAM** indicator flashes and the display briefly shows "P 01" then "00" flashes indicating that you can select the first track to be programmed.



- 3.) Press the ►► or ◀◀ buttons to select the first track. The desired track number flashes on the display.



- 4.) Press the **PROGRAM** button again. The selected track is entered in program memory number 01 and the display advances to "P 02" then "00" flashes again indicating that you can select the next track to be programmed.



- 5.) Press the ►► or ◀◀ buttons to select the next track to be programmed, and press the **PROGRAM** button to enter the track in the memory.
- 6.) Repeat step 5 to program up to 20 tracks in the memory.



7.) After you have programmed all the desired tracks press the ►|| button to begin programmed playback.

The **PROGRAM** indicator stops flashing and remains 'On'. Playback will begin on the first track you programmed and continue until all programmed tracks have been played.



**Notes:**

- After all programmed tracks have played the player stops but the program remains in the memory.

Press the **PROGRAM** button and then the ►|| button to begin programmed playback again.

- To clear the program from the memory after the disc stops, press the **PROGRAM** button and then press the ■ Stop button.

Opening the CD door, pressing the ⏻ **POWER/ALARM OFF** button to shut the unit 'Off', or by switching to other function also clears the program.

**Program Repeat Playback**

You may use the Program and Repeat features together to repeat a programmed sequence of tracks.

Simply enter the desired tracks in the program memory as described on page 17, then press the **P-MODE** button twice to select 'All Tracks Repeat'.

The **PROGRAM** and **REPEAT** indicators will both come 'On'.



Press ►|| to begin Program Repeat playback.



## Alarm Operation

This unit gives you the option of waking to an electronic Buzzer alarm, the AM/FM Radio, or the CD player.

**Note:** *Whichever alarm mode you select – **BUZZER, CD, FM ST** or **AM** – will apply to both alarms.*

Refer to “**Setting The Wake Up Times**” on page 10. Adjust the wake up time(s) if necessary.

- 1.) Set the **BUZZER-CD-FM ST-AM** selector to the desired wake up mode.
- 2.) Press the **AL 1** and/or **AL 2** buttons once. The respective alarm time flashes for few seconds, then returns to correct time.



The **ALARM 1, ALARM 2** or both indicators come ‘On’.

- 3.) At the selected wake up time the selected alarm mode turns ‘On’.

The **ALARM** indicator flashes.



The selected alarm will continue for 60 minutes and then turn ‘Off’ and reset itself for the following day.

- 4.) To stop the alarm immediately, press the **POWER/ALARM OFF** button. The alarm stops and resets itself for the following day.
- 5.) To cancel the alarm completely press the **AL 1** and/or **AL 2** buttons once to turn ‘Off’. The respective **ALARM** indicator disappears.



**Notes:**

- A.) *If “Waking to Radio”, make sure you have tuned to the desired station and adjusted the volume to the desired level.*
- B.) *If “Waking to CD”, make sure there is a CD in the player and the volume is set to the desired level.*
- C.) *In CD wake up mode the CD will play for 60 minutes, or until the end of the disc, whichever comes first.*

**Snooze/Repeat Alarm**

After the alarm turns ‘On’ in the morning you can press the **SNOOZE** button for a few extra minutes sleep. The alarm will stop for approximately 6 minutes and then come on again. Snooze operation can be repeated several times if desired, but after one hour the alarm will not turn ‘On’ again.



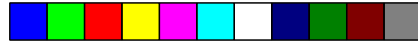

## Sleep To Music Timer

You can use the sleep timer to fall asleep to the Radio or CD player for **90, 60, 30** or **15** minutes and have the unit shut off automatically.

- Press the  **POWER/ALARM OFF** button or simply the **SLEEP** button to turn the power 'On'.  
Operate the Radio or CD player as usual. Adjust the volume to the desired level. The level you select for "Sleep To Music" is the same level you will hear when the alarm turns 'On' in the morning.
- Press the **SLEEP** button to select the desired amount of sleep time as follows:



	<u>Display</u>	<u>Meaning</u>
1st Press	"90"	90 Minutes Till Shut Off.
2nd Press	"60"	60 Minutes Till Shut Off.
3rd Press	"30"	30 Minutes Till Shut Off.
4th Press	"15"	15 Minutes Till Shut Off.
5th Press	"Correct Time"	Sleep Off.

- When the display shows the desired amount of time, stop pressing the **SLEEP** button.

After 5 seconds the display changes back to the correct time.



The Radio or CD player will continue until the sleep timer counts down to "00" and then shut off automatically.

- To stop the Radio or CD player before the sleep timer counts down to "00", press the  **POWER/ALARM OFF** button to turn the unit 'Off'.

### Notes:

- *If you set the sleep time for either 90 or 60 minutes and you are playing a CD that is only 48 minutes long, for example, playback will stop at the end of the disc.*
- *Be sure the **BUZZER-CD-FM ST-AM** selector is set to the **CD, FM ST** or **AM** position before you press the **SLEEP** button.  
No sound will be heard if the **BUZZER-CD-FM ST-AM** selector is set to the **BUZZER** position.*



## CARE AND MAINTENANCE

### Compact Disc Care

- To remove a disc from its storage case, press down on the center of the case and lift the disc out, holding it carefully by the edges.

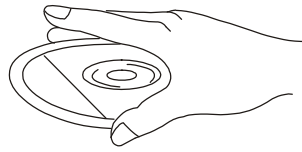
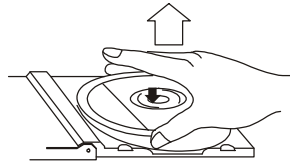

- Fingerprints and dust should be carefully wiped off the disc's recorded surface with a soft cloth. Unlike conventional records, compact discs have no grooves to collect dust and microscopic debris, so gently wiping with a soft cloth should remove most particles. Wipe in a straight line from the inside to the outside of the disc. Small dust particles and light stains will have absolutely no effect on reproduction quality.

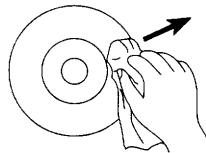
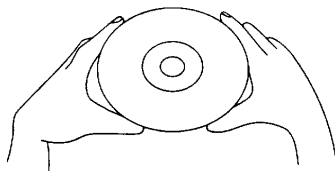

- Clean the disc periodically with a soft, lint-free, dry cloth. Never use detergents or abrasive cleaners to clean the disc. If necessary, use a CD cleaning kit.
- Never write on or affix labels to the surface of compact discs.



### Care Of The Cabinet

- If the cabinet becomes dusty wipe it with a soft dry dust cloth. Do not use any wax or polish sprays on the cabinet.
- If the front panel becomes dirty or smudged with fingerprints it may be cleaned with a soft cloth slightly dampened with a mild soap and water solution. Never use abrasive cloths or polishes as these will mar the finish of your unit.

### Caution

Never allow any water or other liquids to get inside the unit while cleaning.





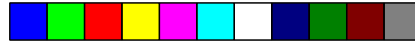

## TROUBLESHOOTING GUIDE

Should this unit exhibit a problem, check the following before seeking service.

Symptom	Possible Cause	Solution
<b>Radio</b>		
Noise or sound distorted on AM or FM broadcasts.	Station not tuned properly for FM ST or AM.	Retune the FM ST or AM broadcast station.
	<b>FM:</b> FM Wire antenna is not extended.	Extend FM Wire antenna.
	<b>AM:</b> The bar antenna is not positioned correctly.	Reposition the unit until best reception is obtained.
FM ST. indicator does not light.	You have tuned to a FM mono station.	Select another FM stereo station and set to FM ST.
AM or FM, no sound.	Function switch is not set to AM or FM ST.	Set Function switch to AM or FM ST. as desired.
	Volume at minimum.	Increase Volume.
<b>Compact Disc Player</b>		
CD Player will not play.	Function switch is not set to CD.	Set Function switch to CD.
	CD is not installed or installed incorrectly.	Insert CD with label side up.
CD skips while playing.	Disc is dirty or scratched.	Wipe disc with cloth or use another disc.



**Emerson®**

SERVICE

TO FIND THE LOCATION AND PHONE NUMBER OF YOUR NEAREST SERVICE CENTER PERMITTED TO PERFORM WARRANTY...

CALL TOLL FREE: 1-800-695-0098

FOR ADDITIONAL SET-UP OR OPERATING ASSISTANCE

PLEASE CALL:  
1-800-898-9020

FOR CUSTOMER SERVICE, PLEASE WRITE TO:

Emerson Radio Corp.,  
Consumer Affairs Dept.,  
5101 Statesman Drive,  
Irving, TX 75063.



**LIMITED WARRANTY**

Emerson Radio Corp. warrants manufacturing defects in original material, including original parts and workmanship, under normal use and conditions, for a period of ninety (90) days from the date of original purchase in the U.S. With your dated proof of purchase, we will provide repair service at no charge for labor and parts at an authorized Depot Repair Facility, or replace the product in our discretion. For repair or replacement, pack your unit in a padded box, enclose your check or money order payable to Emerson Radio Corp. in the amount of \$9.00 (not required by California residents) to cover shipping and handling costs, and enclose a copy of your proof of purchase. Send your unit to:

Emerson Radio Corp.,  
5101 Statesman Drive,  
Irving, TX 75063.

This warranty does not cover damage from negligence, misuse, abuse, accident, failure to follow operating instructions, commercial use, rental, repairs by an unauthorized facility, or products purchased, used, serviced or damaged outside of the United States.

**THIS WARRANTY GIVES YOU SPECIFIC LEGAL RIGHTS, AND YOU MAY ALSO HAVE OTHER RIGHTS WHICH VARY FROM STATE TO STATE.**

**AU898M**

The serial number can be found on the bottom cabinet. We suggest that you record the serial number of your unit in the space below for future reference.

Model No: **CKD9906**

Serial Number: \_\_\_\_\_





EMERSON  
Part No. 16-2989  
507-02

Printed in China

## Free Manuals Download Website

<http://myh66.com>

<http://usermanuals.us>

<http://www.somanuals.com>

<http://www.4manuals.cc>

<http://www.manual-lib.com>

<http://www.404manual.com>

<http://www.luxmanual.com>

<http://aubethermostatmanual.com>

Golf course search by state

<http://golfingnear.com>

Email search by domain

<http://emailbydomain.com>

Auto manuals search

<http://auto.somanuals.com>

TV manuals search

<http://tv.somanuals.com>