

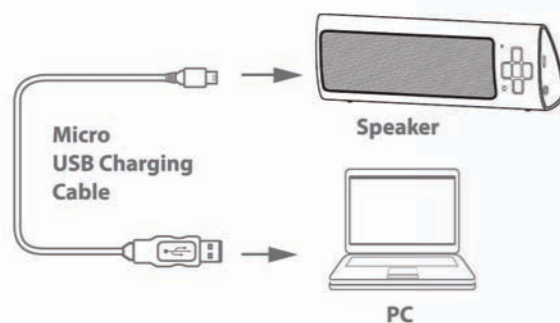

Charging the Bluetooth Speaker

1. Connect the small end of the USB charging cord into the Micro USB charging port on the side of the speaker.
2. Connect the other end of the USB cable to your computer's USB port.
3. The LED indicator light turns RED when charging.
4. The LED indicator light turns OFF when finishing charging.



i When the battery is running low, the speaker will make an alarm sound every 30 seconds.

Bluetooth Wireless Stereo Speaker EBT1150

In the box

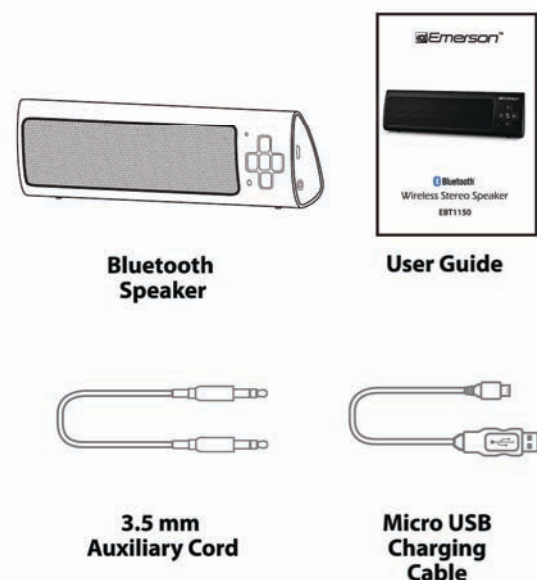

Location of controls

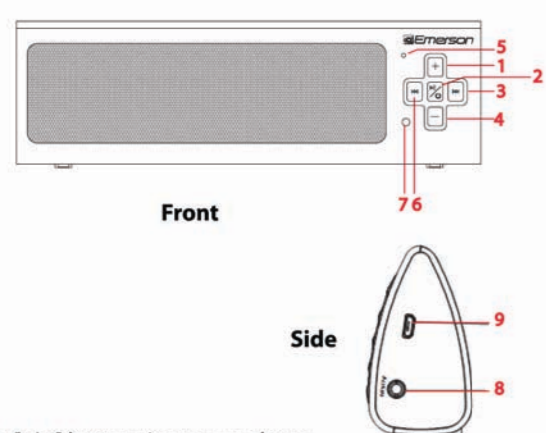

1. [+] button: Increase volume
2. [%] button: Quickpress = Play / Pause / Answer Call / End Call Press & Hold = Power ON/OFF
3. [>>] button: Next track
4. [-] button: Decrease volume
5. Microphone
6. [<<] button: Previous track
7. LED indicator light
8. AUX IN jack
9. Micro USB charging port

Pairing the speaker with a Bluetooth enabled device

1. Keep your Bluetooth Speaker and Bluetooth enabled device within 3 feet of each other during the pairing process.
2. Turn on the Bluetooth Speaker by pressing the [%] button for 3 seconds. If no other devices are paired yet, then the LED indicator light will start to flash BLUE every second, which means the Bluetooth Speaker is already in PAIRING mode.

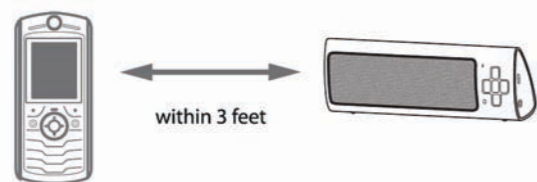

NOTE: If you have already paired a Bluetooth enabled device and it is powered on, the speaker will connect to that device automatically and will not go into pairing mode.

3. Set your mobile phone or other Bluetooth enabled device to search for Bluetooth devices.

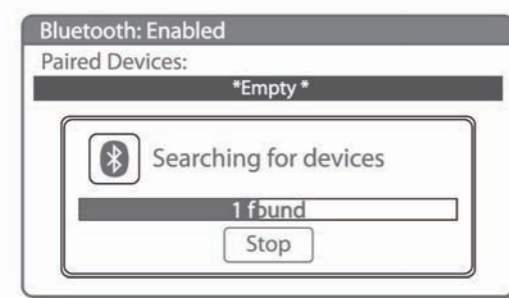

4. When the device finds the **Bluetooth Speaker**, confirm by selecting EBT1150 from the list.

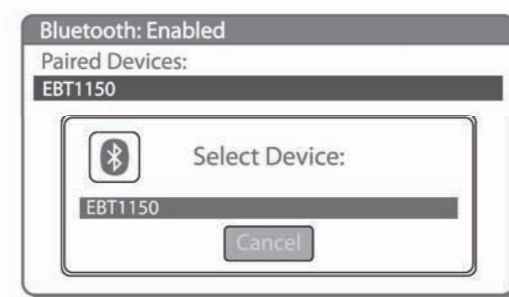

5. Select "Pair" to connect the **Bluetooth Speaker** to your Bluetooth enabled device.

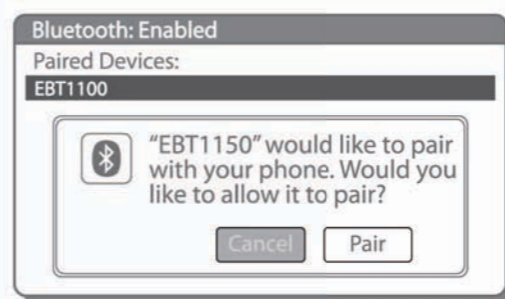

i Depending on which device you are trying to connect the speaker to, it may be necessary to enter a passcode and the following message (or similar) may appear on your device's display:

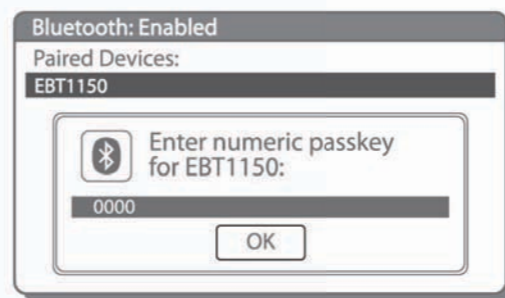

Enter passcode "0000" if prompted by the device.

6. Your Bluetooth enabled device will confirm that the pairing was completed, and prompt you to accept the connection. Please respond **YES** to connect the **Bluetooth Speaker** to your Bluetooth enabled device. If the connection is made, the LED indicator light will blink slowly. After a successful registration, the LED indicator light will stop flashing.

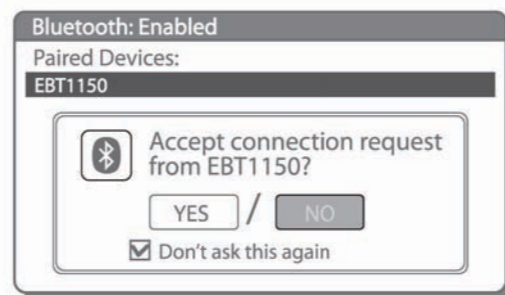

7. When attempting to reconnect the **Bluetooth Speaker** to your Bluetooth enabled device, you may see the message below, and your Bluetooth device will prompt you to accept the connection request to the EBT1150 speaker, and an option not to ask this again. Please accept the connection, and if you select "Don't ask this again", your Bluetooth device will automatically accept future connection requests from your **Bluetooth Speaker**.

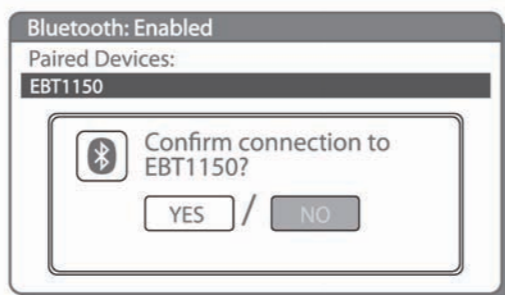

NOTE: If an audio cable is connected to the AUX IN jack of the Bluetooth Speaker, a connection via Bluetooth is not possible. Due to the variety of device manufacturers, models and software versions, a full functionality is not guaranteed.

i The screenshots above are typical of many Bluetooth enabled devices in the market today, and are used to assist in the explanation of the pairing process. Your Bluetooth enabled device's interface and interaction with the Bluetooth Speaker may slightly differ from the illustrations above.

Using your Bluetooth Speaker

Powering ON/OFF

- To turn **ON**, press and hold the [%] button for 3 seconds. The LED indicator light will flash BLUE.
- To turn **OFF**, press and hold the [%] button for 3 seconds. The LED indicator light will blink twice quickly and then turn off.

NOTE: If there are no paired devices in range, when the speaker is turned on, it will go into pairing mode automatically.

Answering / Ending a call

- To answer a call, quickpress the [%] button.
- To end a call, quickpress the [%] button.

Adjusting the volume

Press & hold the [+] or [-] button to adjust the volume to the desired level.

NOTE: You may also adjust the volume from your phone's volume control.

To make a call

Dial the number and press the send button on your mobile phone, the call is automatically transferred to the speaker.

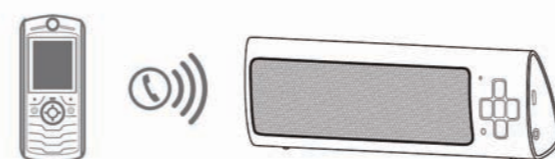

Rejecting Calls

To reject an incoming call, longpress the [%] button for 3 seconds.

Playing Music

To enjoy wireless music on your Bluetooth Speaker, make sure you are connected to a Bluetooth enabled device. Once connected you can press PLAY on your Bluetooth device or you can press the [%] button on the EBT1150 Bluetooth Speaker. Once playback has begun, you can control the music from the control buttons of the Bluetooth speaker (with devices that have the AVRCP Bluetooth profile).

Adjusting the volume

- Quickpress the [+] or [-] button to adjust the volume to the desired level.

i You may also adjust the volume from your mobile phone's volume control.

Play/Pause

Press the [%] button to pause the music. To resume music playback, press the [%] button again.

Skipping Songs

(With devices that have Bluetooth profile)

Press the [>>] button to go to the next song. Press the [<<] button to go to the previous song.

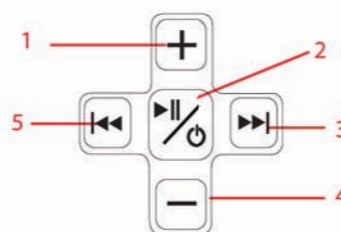

1. [+] button: Increase volume
2. [%] button: Quickpress = Play/Pause/Answer Call/End Call Press & Hold = Power ON/OFF
3. [>>] button: Next track
4. [-] button: Decrease volume
5. [<<] button: Previous track

Answering / Ending Calls

If the Bluetooth Device you are using to play music is a mobile phone and you receive a phone call, the music will be interrupted.

1. If you accept the call, the conversation will be replayed by the Bluetooth Speaker. You can speak into the microphone of the Bluetooth Speaker during the conversation. After you have ended the call, the devices will remain connected and playback will continue.
2. If you reject the call, playback will continue.

Using as a Wired Speaker

The EBT1150 can be used as a wired speaker by using the included 3.5mm Auxiliary Cord.

1. Plug one end of the Auxiliary Cord into the AUX IN jack on the back of the speaker.
2. Plug the other end of the Auxiliary Cord into the headphone jack of any media device that has a 3.5mm headphone jack (this is standard headphone-out-jack).
3. Use your media device's music controls to control the music. When using the Auxiliary Cord, the speaker's buttons will not function.

***The Emerson Bluetooth Speaker is compatible with any brand of Bluetooth-enabled phone or music device that supports Advanced Audio Distribution Profile (A2DP) and Audio Video Remote Control Profile (AVRCP).**

In order for Bluetooth devices to communicate with one another properly, they must utilize the same Bluetooth profile. To determine the profiles supported by your device (mobile phone, gaming console, computer or mp3 player), please refer to the device's user guide.

Certain Bluetooth features including those listed may not be supported by all compatible Bluetooth-enabled devices, and/or the functionality of such features may be limited in certain devices.

Troubleshooting tips

- The Bluetooth Speaker won't turn on.
- The battery may be exhausted. Try charging the battery.
- There is no audio signal through the AUX connection.
- There is no audio signal through the Bluetooth connection.
- The volume level of the external audio source may be too low. Try increasing the volume of the external audio source.
- The volume level of the Bluetooth Speaker may be too low. Try increasing the volume of the Bluetooth Speaker.
- There is no audio signal through the Bluetooth connection.
- If the Bluetooth Speaker is turned OFF, then turn it ON.
- The Bluetooth Speaker may not be paired to the Bluetooth Device. Try checking whether the connection exists. If necessary, try pairing the Bluetooth Device to the Bluetooth Speaker again.
- The audio cable may be connected. If so, remove the cable.
- The volume level of the Bluetooth Device may be too low. Try increasing the volume of the external audio source.
- The volume level of the Bluetooth Speaker may be too low. Try increasing the volume of the Bluetooth Speaker.
- I can pair the Bluetooth Speaker with my Bluetooth device, but I cannot hear any music?
 - Make sure your Bluetooth device supports A2DP profile.
 - Turn up the volume on your Bluetooth device.

Warranty information

i My Bluetooth Device is not able to pair with the Bluetooth Speaker.

- Make sure the **Bluetooth Speaker** is turned ON before beginning the pairing process.
- Keep your Bluetooth Speaker and Bluetooth enabled device within 3 feet of each other during the pairing process.
- Press and hold the [%] button for approximately 3 seconds. The LED indicator light will start to flash BLUE, which means the Bluetooth Speaker is set to PAIRING mode.
- Check that YOUR device's Bluetooth feature is turned ON.
- Try repeating the pairing process, see "Pairing the Speaker with a Bluetooth enabled device".

Safety information

Check local laws regarding use of a mobile handset and wireless headset while driving. If you use the **Bluetooth Headset** driving, ensure your attention and focus remains on your driving. Observe all signs in the designated areas where some electronic devices or RF radio products are required to be switched off. These could include airplanes, hospitals, blasting areas, and potentially explosive atmospheres.

CAUTION: Although this device enables drivers to conduct handsfree conversations, it is still dangerous to drive and use a mobile phone at the same time. Always keep your full attention on your driving.

Product maintenance

Power off this product when not in use. DO NOT expose this product to water or other liquids. DO NOT use abrasive cleaning solvents to clean the **Bluetooth Speaker**. If you will not use the **Bluetooth Speaker** for long periods, be sure store it in a dry place, free from extreme temperature, humidity and dust.

FCC and telephone company information

FCC Part 15

This equipment has been tested and found to comply with the requirements for a Class B digital device under Part 15 of the Federal Communications Commission (FCC) rules. These requirements are intended to provide reasonable protection against harmful interference in a residential installation. This equipment generates, uses and can radiate radio frequency energy and, if not installed and used in accordance with the instructions, may cause harmful interference to radio communications. However, there is no guarantee that interference will not occur in a particular installation. If this equipment does cause harmful radio or television reception, which can be determined by turning the equipment off and on, the user is encouraged to try to correct the interference by one or more of the following measures:

Re-orient or relocate the receiving antenna. Increase the separation between the equipment and receiver. Connect the equipment into an outlet on a circuit different from that to which the receiver is connected. Consult the dealer or an experienced radio/TV technician

Do not attempt to repair or modify this equipment.

Warning: Changes or modifications to this equipment not expressly approved by the party responsible for compliance could void the user's authority to operate the equipment.

Industry Canada

Operation is subject to the following two conditions: (1) This device may not cause interference and (2) This device must accept any interference, including interference that may cause undesired operation of the device.

The term "IC:" before the certification/registration number only signifies that registration was performed based on a Declaration of Conformity indicating that Industry Canada technical specifications were met. It does not imply that Industry Canada approved the equipment.

Limited Warranty

In the unlikely event that this product is defective, or does not perform properly, you may within ninety (90) days from your original date of purchase return it to the authorized service center for repair or exchange.

TO OBTAIN WARRANTY SERVICE:

Provide proof of the date of purchase within the package (Dated bill of sale). Prepay all shipping costs to the authorized and remember to insure your return. Include a return shipping address (no P.O. Boxes), a telephone contact number, and the defective unit within the package. Describe the defect or reason you are returning

Your product will be repaired or replaced, at our option, for the same or similar model of equal value if examination by the service center determines this product is defective. Products received damaged as a result of shipping will require you to file a claim with the carrier.

The shipping address of the authorized service center is:

Southern Telecom Inc.
Customer Service - 2nd Floor
14-C 53rd Street
Brooklyn, NY 11232

Should you have any questions or problems concerning this product, please contact our customer service department at:

1-877-768-8483 (Toll Free)
Monday - Thursday: 9AM - 6PM (EST)
Friday: 9AM - 3PM (EST)
or
via e-mail at
cs@southern telecom.com

Warranty service not provided

This warranty does not cover damage resulting from accident, misuse, abuse, improper installation or operation, lack of reasonable care, and unauthorized modification. This warranty is voided in the event any unauthorized person opens, alters or repairs this product. All products being returned to the authorized service center for repair must be suitably packaged.

Limitation of Warranty:

THE WARRANTY STATED ABOVE IS THE ONLY WARRANTY APPLICABLE TO THIS PRODUCT. ALL OTHER WARRANTIES, EXPRESS OR IMPLIED (INCLUDING ALL IMPLIED WARRANTIES OF MERCHANTABILITY OR FITNESS FOR A PARTICULAR PURPOSE) ARE HEREBY DISCLAIMED. NO VERBAL OR WRITTEN INFORMATION GIVEN BY SOUTHERN TELECOM INC. IT'S AGENTS, OR EMPLOYEES SHALL CREATE A GUARANTEE OR IN ANY WAY INCREASE THE SCOPE OF THIS WARRANTY.

REPAIR OR REPLACEMENT AS PROVIDED UNDER THIS WARRANTY IS THE EXCLUSIVE REMEDY OF THE CONSUMER. SOUTHERN TELECOM INC. SHALL NOT BE LIABLE FOR INCIDENTAL OR CONSEQUENTIAL DAMAGES RESULTING FROM THE USE OF THIS PRODUCT OR ARISING OUT OF ANY BREACH OF ANY EXPRESS OR IMPLIED WARRANTY ON THIS PRODUCT. THIS DISCLAIMER OF WARRANTIES AND LIMITED WARRANTY ARE GOVERNED BY THE LAWS OF THE STATE OF NEW YORK. EXCEPT TO THE EXTENT PROHIBITED BY APPLICABLE LAW, ANY IMPLIED WARRANTY OF MERCHANTABILITY OR FITNESS FOR A PARTICULAR PURPOSE ON THIS PRODUCT IS LIMITED TO THE APPLICABLE WARRANTY PERIOD SET FORTH ABOVE.

Some states do not allow the exclusion nor limitation of incidental or consequential damages, or limitations on how long an implied warranty lasts so the above limitations or exclusions may not apply to you. This warranty gives you specific legal rights, and you also may have other rights that vary from state to state.



www.emersonphones.com
Manufactured by Southern Telecom Inc. Brooklyn, NY 11232 © 2013 Southern Telecom Inc. All rights reserved. Emerson and the G-Clef logo are registered trademarks of Emerson Radio Corp. Parsippany, New Jersey USA. The Bluetooth® word mark and logos are owned by the Bluetooth SIG, Inc.

Free Manuals Download Website

<http://myh66.com>

<http://usermanuals.us>

<http://www.somanuals.com>

<http://www.4manuals.cc>

<http://www.manual-lib.com>

<http://www.404manual.com>

<http://www.luxmanual.com>

<http://aubethermostatmanual.com>

Golf course search by state

<http://golfingnear.com>

Email search by domain

<http://emailbydomain.com>

Auto manuals search

<http://auto.somanuals.com>

TV manuals search

<http://tv.somanuals.com>