

Liebert® GXT4™ UPS 208 V, 5000 VA – 10,000 VA, 6000RTL630
User Manual



Table of Content

Important Safety Instructions	1
Glossary of Symbols	3
1.0 Product Description	5
1.1 Features	5
1.2 Available Models	5
1.3 Appearance and Components	6
1.3.1 Appearance	6
1.3.2 Rear Panel Features	6
1.4 Removable Power Distribution Box	9
1.5 Internal Battery Packs	12
1.6 Major Components	12
1.6.1 Transient Voltage Surge Suppression (TVSS) and EMI/RFI Filters	12
1.6.2 Rectifier/Power Factor Correction (PFC) Circuit	13
1.6.3 Inverter	13
1.6.4 Battery Charger	13
1.6.5 DC-to-DC Converter	13
1.6.6 Battery	13
1.6.7 Internal Bypass	13
1.6.8 Maintenance Bypass	13
1.7 Operating Mode	14
1.7.1 Mains Mode	14
1.7.2 Manual Bypass Mode	14
1.7.3 Battery Mode	14
1.7.4 Battery Recharge Mode	14
1.7.5 Frequency Converter Mode	15
1.7.6 Active ECO Mode	15
2.0 Installation	17
2.1 Unpacking and Inspection	17
2.2 What's Included	17
2.3 Preparation for Installation	18
2.3.1 Installation Environment	18

2.4 Install the Main Cabinet	18
2.4.1 Tower UPS Installation	18
2.4.2 Rack Installation	19
2.5 External Battery Cabinet Installation	20
2.6 Connect Input/Output Power	21
2.6.1 Install the Power Distribution Box on 5000VA and 6000VA Models	21
2.6.2 Remove the Power Distribution Box from 5000VA and 6000VA Models	22
2.6.3 Remove the Power Distribution Cover from 8000VA and 10,000VA Models	23
2.6.4 Install the Power Distribution Box on 8000VA and 10,000VA Models	24
2.6.5 Distribution Box Electrical Connections	24
2.6.5.1 Terminal Block Connections	25
2.7 IT Power System Configuration	27
3.0 Operation and Display Panel	29
3.1 LED Indicators	29
3.2 Control Buttons	30
3.3 LCD	30
3.4 Menu Structure	31
3.4.1 Startup Screen	32
3.4.2 Default Screen	33
3.4.3 Main Menu Screen	33
3.4.4 Prompt List	42
3.4.5 Warning List	42
3.4.6 Fault List	43
4.0 Operation	45
4.1 Startup Checklist for the Liebert GXT4	45
4.2 Starting the UPS	45
4.3 Manual Battery Test	45
4.4 Manual Bypass	46
4.5 Shut Down the GXT4	46
4.6 Disconnecting Input Power from the GXT4	46
4.7 Maintenance Bypass	46

5.0 Communication	47
5.1 Liebert IntelliSlot Communication Cards	47
5.1.1 Liebert MultiLink	47
5.2 USB Port Communication	48
5.2.1 Configuration Program	48
5.3 Terminal Block Communication	49
5.3.1 Any Mode Shutdown	50
5.3.2 Battery Mode Shutdown	50
5.3.3 On Battery	51
5.3.4 Low Battery	51
5.4 Remote Emergency Power Off—GXT4-6000RTL630	51
6.0 Maintenance	53
6.1 Replacing the Internal Battery Pack	53
6.1.1 Battery Replacement Procedures	54
6.2 Battery Charging	55
6.3 Precautions	56
6.4 Checking UPS Status	56
6.5 Checking UPS Functions	56
6.6 Replacing the Power Module on 8000 and 10,000VA models	57
7.0 Troubleshooting	59
7.1 UPS Symptoms	59
7.1.1 Indicator and LCD	59
7.1.2 Audible Alarm	60
7.2 Troubleshooting	60
8.0 Specifications	63
8.1 Auto-Learning Battery Run Times	70
8.2 Product Warranty Registration	70
8.3 Technical Support	70

List of Figures

Figure 1-1: Liebert GXT4 5000VA and 6000VA, front view	6
Figure 1-2: Rear panel—5000VA and 6000VA with input power hard-wired box	7
Figure 1-3: Rear panel—GXT4-6000RTL630	7
Figure 1-4: Rear panel—8000VA	8
Figure 1-5: Power distribution models for 5000 VA and 6000 VA models	9
Figure 1-6: Power distribution models for 8000 VA and 10,000 VA models	10
Figure 1-7: Power distribution models for 8000 VA and 10,000 VA models (<i>continued</i>)	11
Figure 1-8: Internal battery pack with connector	12
Figure 2-1: Support bases	18
Figure 2-2: Remove the front plastic bezel cover	19
Figure 2-3: Rotate the operation and display panel	19
Figure 2-4: External battery cabinets connected to GXT4	20
Figure 2-5: Power distribution box removal from 5000VA and 6000VA models	22
Figure 2-6: Power distribution box removal from 8000VA and 10,000VA models	23
Figure 2-7: Distribution box electrical connections diagram	25
Figure 2-8: Terminal block connections	26
Figure 3: Remove cover from IT Power System Connectors compartment	27
Figure 3-1: Operation and display panel	29
Figure 3-2: Menu structure	31
Figure 3-3: Startup screen	32
Figure 3-4: Startup screens	32
Figure 3-5: Starting and Start Successful screens	32
Figure 3-6: Default screen	33
Figure 3-7: Main Menu screen	33
Figure 3-8: Status screens	34
Figure 3-9: CONFIGURATION screen	34
Figure 3-10: UPS screens	35
Figure 3-11: Battery screen	35
Figure 3-12: ECO Mode screen	36
Figure 3-13: LCD screen	36
Figure 3-14: Language screen	37
Figure 3-15: Color screen	37
Figure 3-16: Factory Default screen	37
Figure 3-17: Control screen	38
Figure 3-18: Turn UPS On or Off screen	38
Figure 3-19: Alarm Control screen	39
Figure 3-20: Batt Test screen	39
Figure 3-21: Log screens	39
Figure 3-22: Clear Log screen	40
Figure 3-23: About screen	40
Figure 3-24: Network screens	41

Figure 5-1: Terminal-block communication pin layout	49
Figure 5-2: REPO switch connection diagram	51
Figure 6-1: Removing the front bezel cover and battery door	54
Figure 6-2: Disconnecting the battery plug and battery receptacle (front view)	54
Figure 6-3: Pull out the battery	55
Figure 6-4: Removing power module from Liebert GXT4 8000 and 10,000VA models	57

List of Tables

Table 1-1: UPS models, power ratings.	5
Table 2-1: Branch circuit breaker ratings	24
Table 2-2: Electrical specifications	25
Table 3-1: LED indicators	29
Table 3-2: Control buttons	30
Table 3-3: System prompts and meanings	42
Table 3-4: Warning list	42
Table 3-5: Fault list.	43
Table 5-1: Output voltage option	48
Table 6-1: Replacement internal battery pack model number	53
Table 7-1: Description of the displayed fault	59
Table 7-2: Audible alarm description	60
Table 7-3: Troubleshooting table	60
Table 8-1: UPS specifications—5000, 6000, 8000 and 10,000 models	63
Table 8-2: UPS specifications—Liebert GXT4-6000RTL630	64
Table 8-3: Internal battery cabinet specifications	65
Table 8-4: External battery cabinet specifications	66
Table 8-5: Power distribution specifications: GXT4-5000RT208, GXT4-6000RT208 and GXT4-6000RTL630 *	66
Table 8-6: Power distribution box specifications for GXT4-8000RT208 and GXT4-10000RT208	67
Table 8-7: Power distribution box specifications for GXT4-8000RT208 and GXT4-10000RT208	67
Table 8-8: Battery run time, minutes	68

Important Safety Instructions

SAVE THESE INSTRUCTIONS

This manual contains important safety instructions. Read all safety and operating instructions before operating the uninterruptible power system (UPS). Adhere to all warnings on the unit and in this manual. Follow all operating and user instructions. This equipment can be operated by individuals without previous training.

This product is designed for commercial/industrial use only. It is not intended for use with life support and other designated "critical" devices. Maximum load must not exceed that shown on the UPS rating label. The UPS is designed for data processing equipment. The UPS is not for use in a computer room as defined in the standard, Protection of Electronic Computer/Data Processing Equipment ANSI/NFPA 75. If uncertain, consult your dealer or local Emerson Network Power® representative.

This UPS is designed for use on a properly grounded (earthed), 100/200, 110/220, 115/230, 120/208, 120/240 or 127/220VAC, 50 or 60Hz supply. The factory default setting is 120/208VAC, 60Hz. Installation instructions and warning notices are in this manual.

The Liebert GXT4 208VAC 5000 - 10000 is designed for use with a four-wire input (L1, L2, N, G).

The Liebert GXT4-6000RTL630 is designed be used with a three-wire, two-phase utility source (L1, L2, G).



WARNING

The battery can present a risk of electrical shock and high short circuit current. The following precautions should be observed when replacing the battery pack:

- Wear rubber gloves and boots
- Remove rings, watches and other metal objects.
- Use tools with insulated handles.
- Do not lay tools or other metal objects on the batteries.
- If the battery kit is damaged in any way or shows signs of leakage, contact your local Emerson representative immediately.
- Do not dispose of batteries in a fire. The batteries may explode.
- Handle, transport and recycle batteries in accordance with local regulations.



WARNING

Although the Liebert GXT4 has been designed and manufactured to ensure personal safety, improper use can result in electrical shock or fire. To ensure safety, observe the following precautions:

- Turn Off and unplug the Liebert GXT4 before cleaning it.
- Clean the UPS with a dry cloth. Do not use liquid or aerosol cleaners.
- Never block or insert any objects into the ventilation holes or other openings of the UPS.
- Do not place the Liebert GXT4 power cord where it might be damaged.

ELECTROMAGNETIC COMPATIBILITY—The Liebert GXT4 complies with the limits for a Class A digital device, pursuant to Part 15 of FCC rules.

Operation is subject to the following conditions:

- This device may not cause harmful interference.
- This device must accept any interference received, including interference that may cause undesired operation. Operating this device in a residential area is likely to cause harmful interference that users must correct at their own expense.

The Liebert GXT4 series complies with the requirements of EMC Directive 2004/108/EC and the published technical standards. Continued compliance requires installation in accordance with these instructions and use of accessories approved by Emerson.

NOTICE

This is a product for restricted sales distribution to informed partners. Installation restrictions or additional measures may be needed to prevent radio interference.

Operate the UPS in an indoor environment only in an ambient temperature range of 0-40°C (32-104°F). Install it in a clean environment, free from moisture, flammable liquids, gases and corrosive substances.

The Liebert GXT4-5000RT208, Liebert GXT4-6000RT208 and the Liebert GXT4-6000RTL630 contain no user-serviceable parts except the internal battery pack. The Liebert GXT4-10000RT208 and the Liebert GXT4-8000RT208 contain no user-serviceable parts except the internal battery pack and the Power Module. The UPS On/Off push buttons do not electrically isolate internal parts. Under no circumstances attempt to gain access internally due to the risk of electric shock or burn.

Do not continue to use the UPS if the front panel indications are not in accordance with these operating instructions or the UPS performance alters in use. Refer all faults to your dealer.

Servicing of batteries should be performed or supervised by personnel knowledgeable of batteries and the required precautions. Keep unauthorized personnel away from the batteries. Keep unauthorized personnel away from the batteries. Proper disposal of batteries is required. Refer to your local laws and regulations for disposal requirements.

Never block or insert any object into the ventilation holes or other openings.

DO NOT CONNECT equipment that could overload the UPS or demand DC current from the UPS, for example: electric drills, vacuum cleaners, laser printers, hair dryers or any appliance using half-wave rectification.











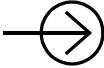

Storing magnetic media on top of the UPS may result in data loss or corruption.

Turn Off and isolate the UPS before cleaning it. Use only a soft cloth, never liquid or aerosol cleaners.

Information for the Protection of the Environment

UPS SERVICING—This UPS makes use of components dangerous for the environment (electronic cards, electronic components). The components removed must be taken to specialized collection and disposal centers.

Glossary of Symbols

	Risk of electrical shock
	Indicates caution followed by important instructions
	AC input
	AC output
	Requests the user to consult the manual
	Indicates the unit contains a valve-regulated lead acid battery
	Recycle
	DC voltage
	Equipment grounding conductor
	Bonded to ground
	AC voltage
	WEEE

Page intentionally left blank.

1.0 Product Description

The Liebert GXT4 is a compact, online uninterruptible power system (UPS) that continuously conditions and regulates its output voltage. The UPS is designed to supply microcomputers and other sensitive electronic equipment with clean sine wave input power.

Upon generation, AC power is clean and stable. However, during transmission and distribution it is subject to voltage sags, spikes and complete failure that may interrupt computer operations, cause data loss and damage equipment.

The Liebert GXT4 protects equipment from these disturbances. The Liebert GXT4 continuously charges its batteries from the mains, enabling it to supply power to connected loads, even when the mains fail.

This section describes the UPS, its features, models, appearance and components, operating principles and operating mode.

1.1 Features

The UPS includes these features:

- Intelligent battery management to extend battery life
- LCD for user-friendly operation and local monitoring and configuration of operational parameters
- Flexible network management with Liebert MultiLink® software
- Fan fault self-inspection and automated diagnostic function
- Intelligent fan operation, automatically changing rotation speed depending on system requirements, to decrease power consumption and noise
- Input circuit breaker to ease recovery from overloads
- CE mark and safety approval from CE
- Communication options: USB port, Liebert IntelliSlot® port and terminal block communication
- Dry contacts for remote monitoring
- Input power factor greater than 0.99
- Output voltage selection function

1.2 Available Models

Available models of the UPS are listed in **Table 1-1**:

Table 1-1 UPS models, power ratings

Model Number	Nominal Power Rating
GXT4-5000RT208	5000VA / 4000W
GXT4-6000RT208	6000VA / 4800W
GXT4-6000RTL630	6000VA / 4200W
GXT4-8000RT208	8000VA / 7200W
GXT4-10000RT208	10000VA / 9000W

1.3 Appearance and Components

1.3.1 Appearance

The Liebert GXT4 rack/tower models in various power ratings have the same general appearance, controls and features (see **Figure 1-1**). The various rack/tower models differ largely in the type of receptacles each has.

Figure 1-1 Liebert GXT4 5000VA and 6000VA, front view

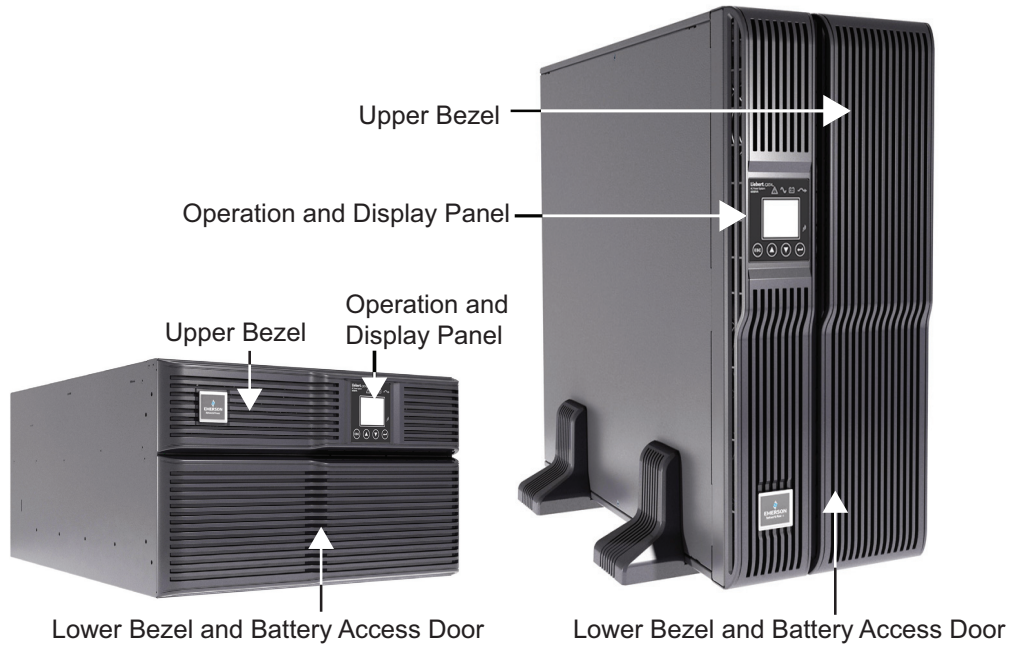

1.3.2 Rear Panel Features

The rear panel of the Liebert GXT4 has these features:

- Liebert IntelliSlot® Port
- USB port
- Input Circuit Breaker
- Maintenance Bypass Circuit Breaker (not present on all optional POD's)
- REPO connection
- Input Receptacle
- General Output Receptacles (on optional PODs)
- External Battery Connector
- Cooling Fan
- Terminal Block Communication
- Output Circuit Breakers (on optional PODs)

Figure 1-2 Rear panel—5000VA and 6000VA with input power hard-wired box

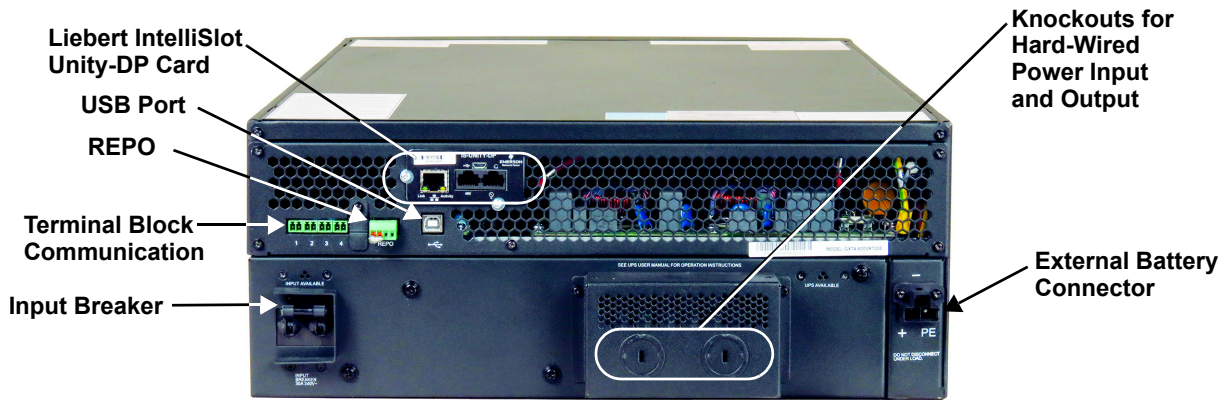

NOTE

Hard-wired and hard-wired/receptacle boxes that include a manual bypass switch permit AC power to continue to flow from the utility input to the load while the box is removed from the UPS. For details, refer to 2.6 - Connect Input/Output Power.

Figure 1-3 Rear panel—GXT4-6000RTL630

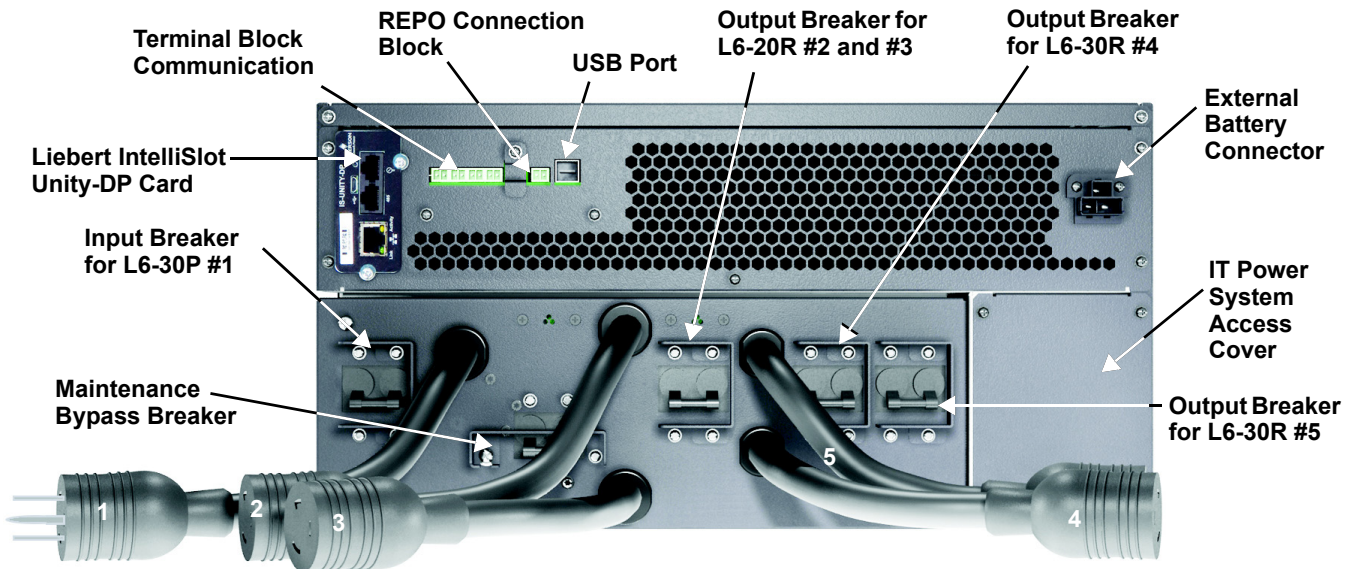
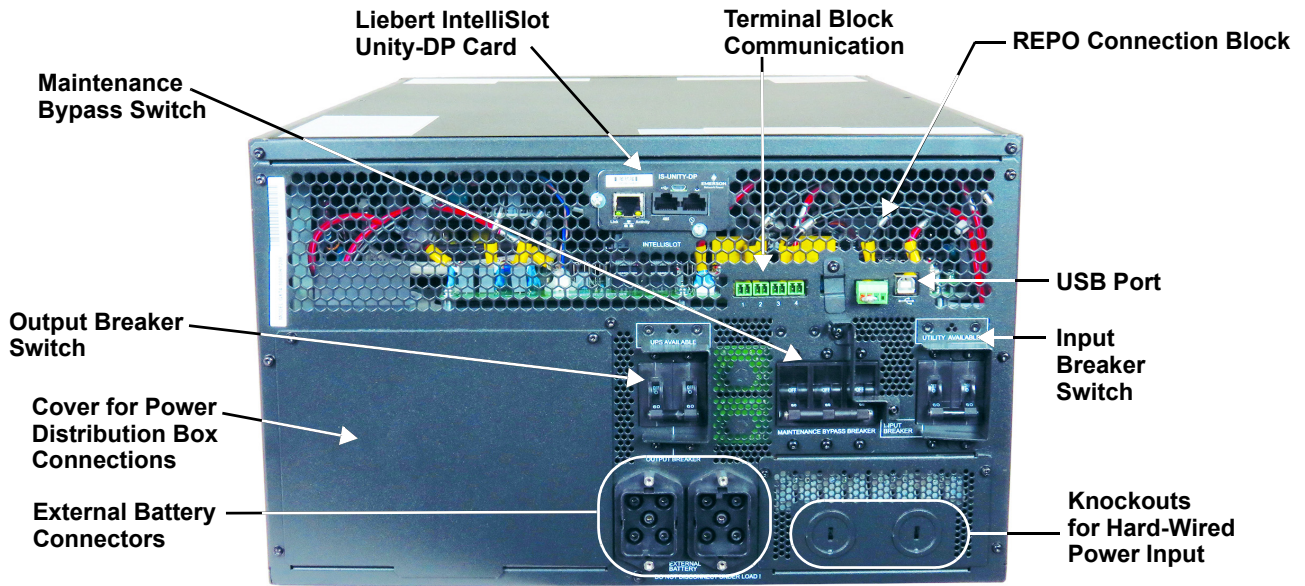

Figure 1-4 Rear panel—8000VA



1.4 Removable Power Distribution Box

The UPS is shipped with a power-distribution pack installed. This box contains the UPS input circuit breaker.

**Figure 1-5 Power distribution models for 5000 VA and 6000 VA models
PD2-001 shown as example;
similar features on other distribution
boxes arranged differently**

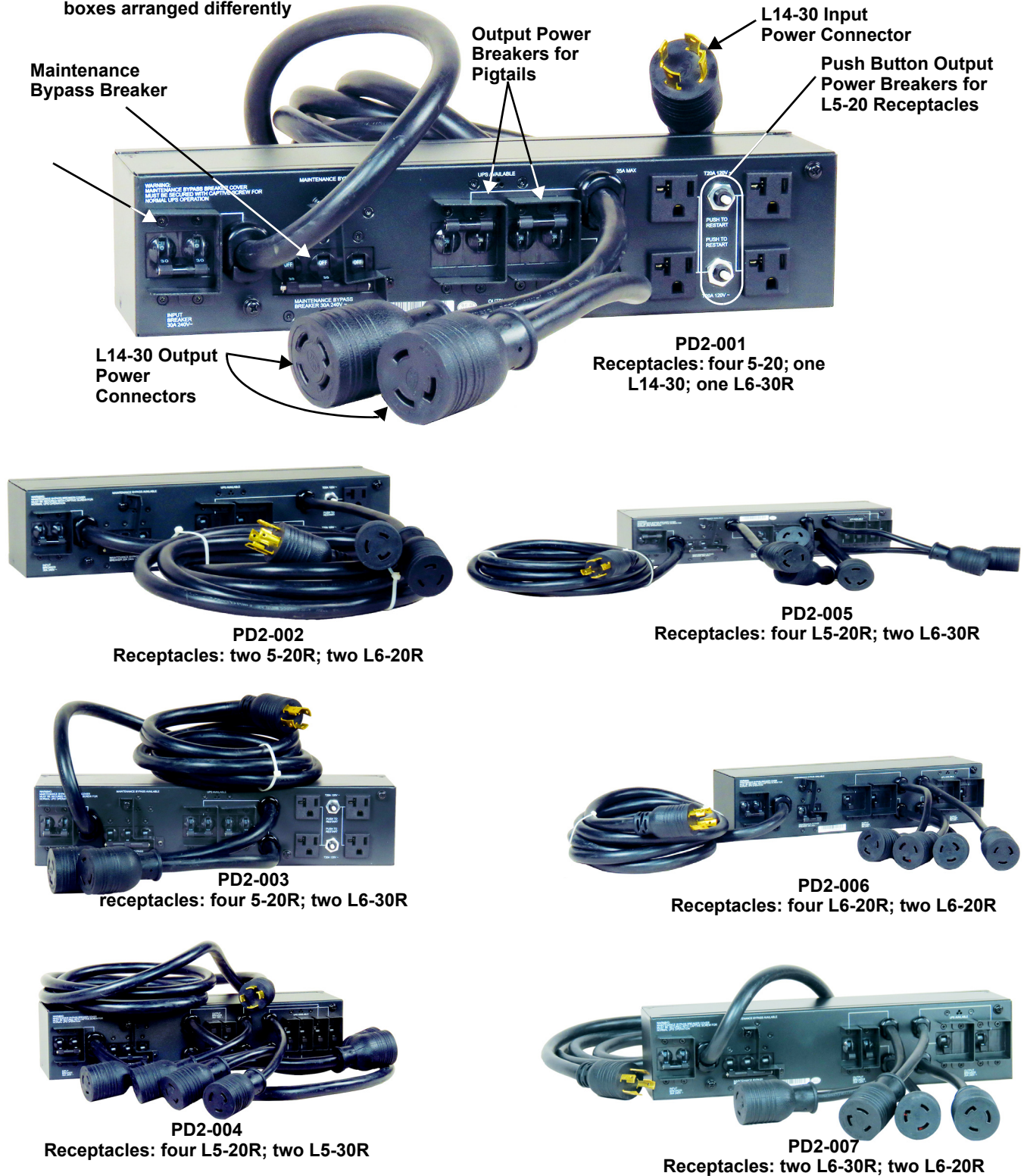

Figure 1-6 Power distribution models for 8000 VA and 10,000 VA models

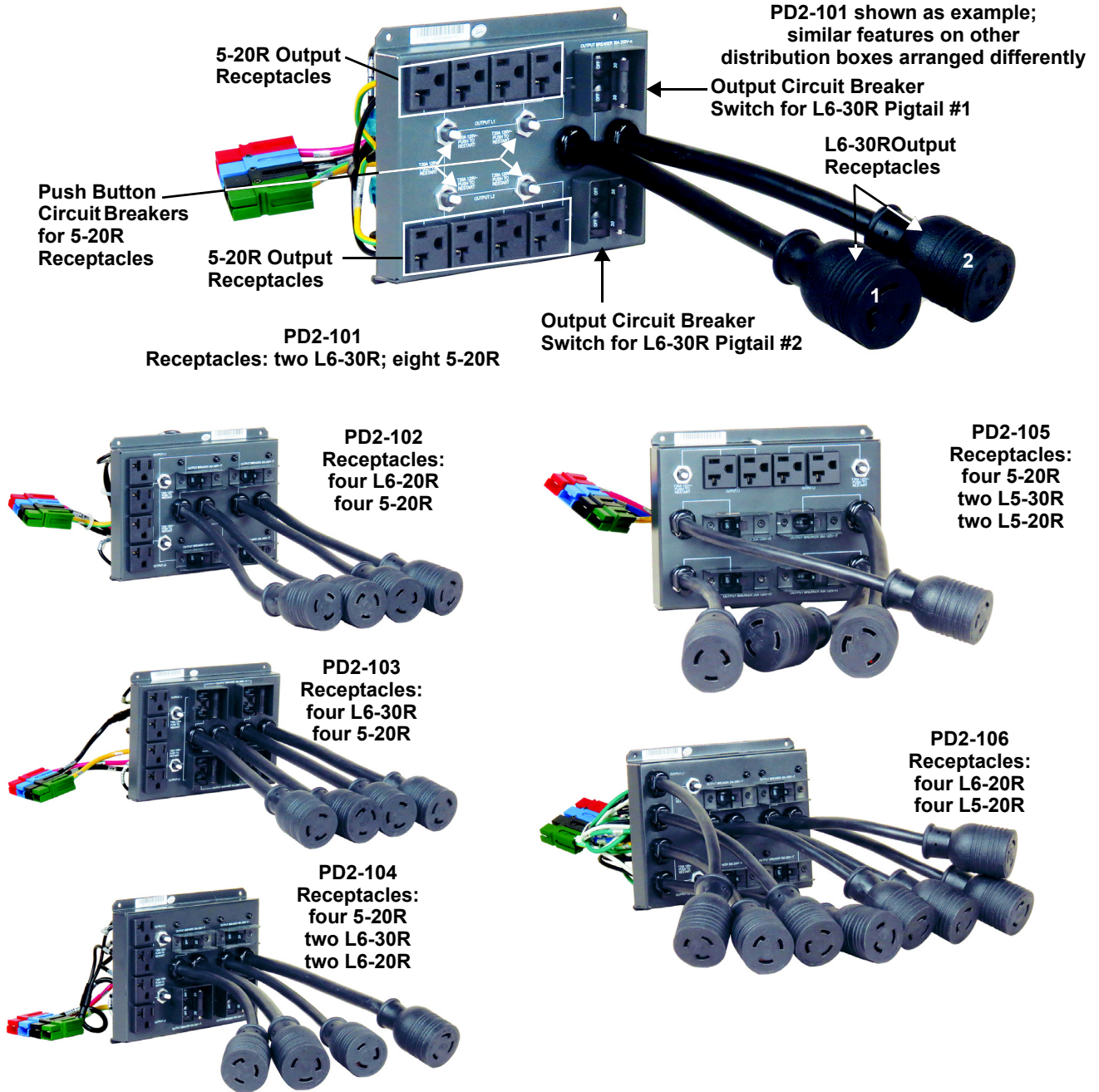
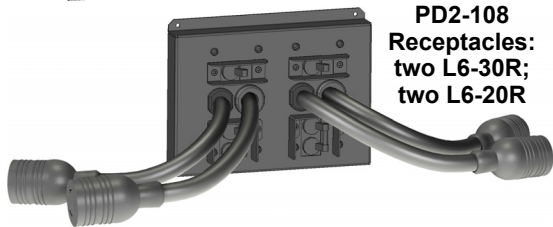
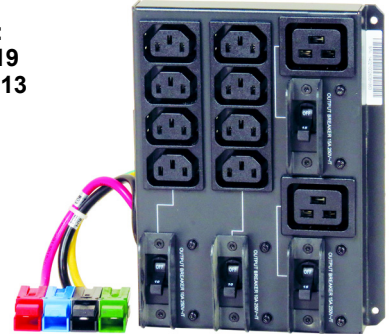

Figure 1-7 Power distribution models for 8000 VA and 10,000 VA models (continued)



PD2-201
Receptacles:
two IEC320-C19
eight IEC320-C13



PD2-202
Receptacles:
(12) IEC320-C13

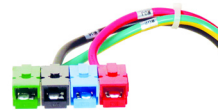
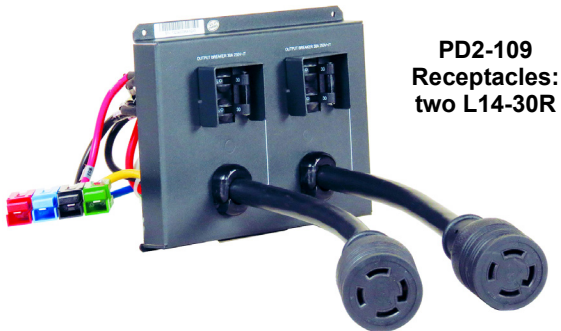
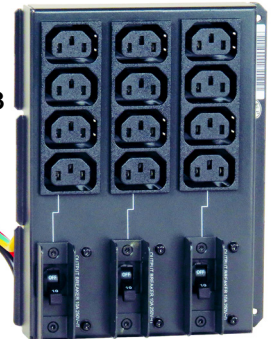

PD2-200
Receptacles:
four IEC320-C19
four IEC320-C13

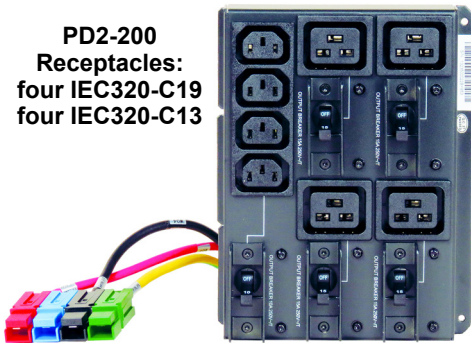

PD2-204
Receptacles:
two IEC309-32A
four IEC320-C13

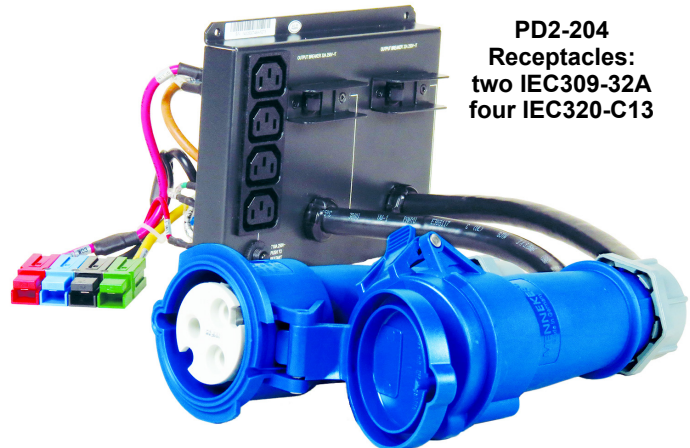

1.5 Internal Battery Packs

The UPS has two internal battery packs behind a battery access door on the front of the unit. Each internal battery pack is fitted with a connector to link to the UPS.



NOTE

GXT4 10,000-VA battery pack shown in **Figure 1-8**. 5000-VA and 6000-VA battery packs have the same features.

Figure 1-8 Internal battery pack with connector

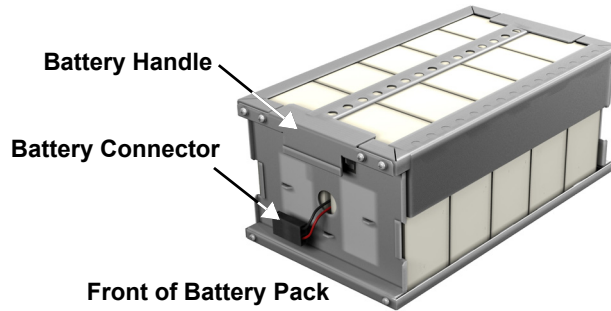

1.6 Major Components

The UPS is composed of mains input, TVSS and EMI/RFI filters, rectifier/PFC, inverter, battery charger, DC-to-DC converter, battery, dynamic bypass and UPS output.

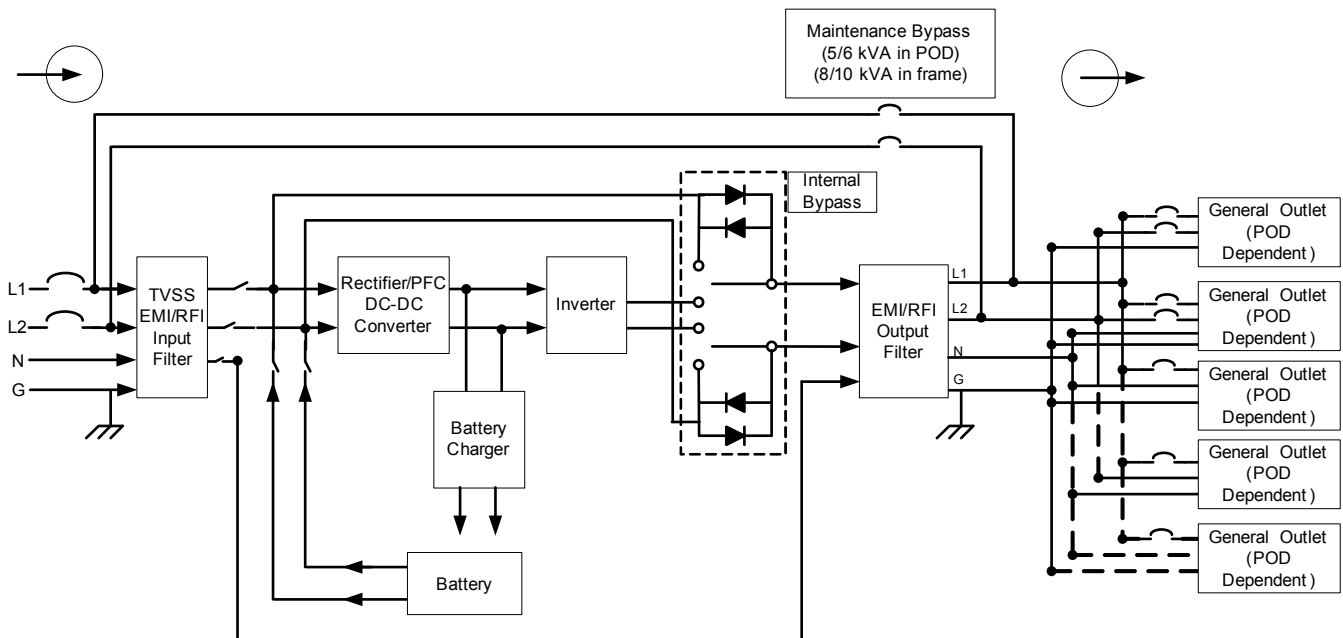

1.6.1 Transient Voltage Surge Suppression (TVSS) and EMI/RFI Filters

These UPS components provide surge protection and filter both electromagnetic interference (EMI) and radio frequency interference (RFI). They minimize any surges or interference present in the mains line and keep the sensitive equipment protected.

1.6.2 Rectifier/Power Factor Correction (PFC) Circuit

In normal operation, the rectifier/power factor correction (PFC) circuit converts mains AC power to regulated DC power for use by the inverter while ensuring that the waveshape of the input current used by the UPS is near ideal. Extracting this sinewave input current achieves two objectives:

- The mains power is used as efficiently as possible by the UPS.
- The amount of distortion reflected on the mains is reduced.

This results in cleaner power being available to other devices in the building not being protected by the Liebert GXT4.

1.6.3 Inverter

In normal operation, the inverter utilizes the DC output of the power factor correction circuit and inverts it into precise, regulated sinewave AC power. Upon a mains power failure, the inverter receives its required energy from the battery through the DC-to-DC converter. In both modes of operation, the UPS inverter is on-line and continuously generating clean, precise, regulated AC output power.

1.6.4 Battery Charger

The battery charger utilizes energy from the mains power and precisely regulates it to continuously float charge the batteries. The batteries are being charged whenever the Liebert GXT4 is connected to mains power.

1.6.5 DC-to-DC Converter

The DC-to-DC converter utilizes energy from the battery system and raises the DC voltage to the optimum operating voltage for the inverter. This allows the inverter to operate continuously at its optimum efficiency and voltage, thus increasing reliability.

1.6.6 Battery

The Liebert GXT4 utilizes valve-regulated, nonspillable, lead acid batteries. To maintain battery design life, operate the UPS in an ambient temperature of 15°C to 25°C (59°F to 77°F). Optional external battery cabinets are available to extend battery run times. For run times, see **Table 8-8**.

1.6.7 Internal Bypass

The Liebert GXT4 provides an alternate path for mains power to the connected load in the unlikely event of a UPS malfunction. Should the UPS have an overload, overtemperature or any other UPS failure condition, the UPS automatically transfers the connected load to bypass. Bypass operation is indicated by an audible alarm and illuminated amber Bypass LED (other LEDs may be illuminated to indicate the diagnosed problem). To manually transfer the connected load from the inverter to bypass, press the Standby/Manual Bypass button once and hold it for about 2 seconds

1.6.8 Maintenance Bypass

The Liebert GXT4 provides a manual maintenance bypass in a removable section of the rear of the UPS. This allows replacement of the UPS in the event of a UPS malfunction while keeping the connected equipment powered with utility power.



NOTE

The bypass power path does NOT protect the connected equipment from disturbances in the mains supply.

1.7 Operating Mode

The UPS operation modes include the following: Mains (AC) Mode, Bypass Mode, Battery Mode, Battery Recharge Mode, Active ECO Mode and Frequency Converter Mode.

Refer to **3.0 - Operation and Display Panel** for details about the operating mode indicators and control buttons.

1.7.1 Mains Mode

During Mains Mode, the mains provides input power to the Liebert GXT4. The filters, PFC circuit and inverter process this power to provide high-quality sine wave power to connected loads. The UPS maintains the batteries in a fully charged state.

1.7.2 Manual Bypass Mode

Manual Bypass Mode occurs when the unit is manually placed in internal bypass by navigating the LCD menu to select **3 Control > 1 Turn On & Off > Turn UPS Bypass**. Bypass operation is indicated by an audible alarm and illuminated amber bypass indicator. (If other indicators are illuminated, refer to **7.0 - Troubleshooting**). During Bypass Mode, mains power bypasses the inverter and provides energy to the connected load.

NOTICE

Risk of loss of power to the connected load. Can cause equipment damage.

Turning Off the UPS in Bypass Mode will result in loss of output power to the connected load.

1.7.3 Battery Mode

The Liebert GXT4 enters Battery Mode when mains power fails or is outside acceptable limits. The battery system supplies power through the DC-to-DC converter to the inverter to generate clean AC power for the connected loads.

When the Liebert GXT4 enters Battery Mode, the UPS sounds a half-second beep at 10-second intervals. When approximately 2 minutes of run time remains, the beeps sound every 5 seconds to warn that the battery is getting low (this Low Battery Warning is user-configurable).

In Battery Mode, the battery indicator will illuminate and the LCD will show the prompt *utility power not available*.

Press either the Up or Down button once, then press the Enter button to clear the prompt and silence the audible alarm. Once the alarm prompt has been acknowledged, the screen showing the estimated battery run time and battery capacity will be visible. Refer to **7.0 - Troubleshooting**.

For approximate battery run times, refer to **Table 8-4**.

NOTICE

Risk of loss of power to the connected load. Can cause equipment damage.

Turning Off the Liebert GXT4 when it is in Battery Mode will result in loss of output power to the connected load.

If the UPS is turned Off manually, it must be manually restarted after mains power returns.

If the UPS is turned Off by a communication signal or because the batteries are depleted, it will operate as set in the configuration program for Auto-Restart (Refer to **5.2.1 - Configuration Program**).

1.7.4 Battery Recharge Mode

Once mains power is applied to the Liebert GXT4, the Battery Charger begins charging the batteries.

1.7.5 Frequency Converter Mode

All models of the Liebert GXT4 are capable of frequency conversion. Frequency Conversion Mode can be selected using the configuration program. Allowable frequency operating modes include:

- Auto Sensing - 50Hz or 60Hz – Bypass Enabled
- Auto Sensing - 50Hz or 60Hz – Bypass Disabled
- Frequency Converter - 50Hz – Bypass Disabled
- Frequency Converter - 60Hz – Bypass Disabled



NOTE

The default for all models of the Liebert GXT4 is “Auto Sensing - 50Hz or 60Hz – Bypass Enabled.”



WARNING

Risk of electric shock. Can cause injury or death.

Never touch the AC input receptacle while the UPS is operating. Voltage may still be present even when the AC input indicator is Off.

1.7.6 Active ECO Mode

All Liebert GXT4 models can operate in Active ECO Mode. In this mode, the connected equipment is powered through the bypass path to increase efficiency, reducing the electrical costs.

Active ECO mode keeps the rectifier and inverter operating, allowing the inverter to remain synchronized to bypass. This synchronization allows the transfer of the connected equipment to UPS inverter power almost seamlessly if bypass power falls outside the user-set limits. Once bypass power returns within the acceptable parameters, the UPS will return to Active ECO Mode operation.

The default setting is Active ECO Mode Off.

Page intentionally left blank.

2.0 Installation

Do NOT attempt to start the UPS, turn on any circuit breaker or energize the input power until instructed to do so in **4.2 - Starting the UPS**.

2.1 Unpacking and Inspection

Unpack the UPS and conduct the following checks:

- Inspect the UPS for shipping damage. Report any shipping damage to the carrier and your local dealer or Emerson® representative immediately.
- Check the accessories against the delivery list. If there is any discrepancy, contact your local dealer or your Emerson representative immediately



CAUTION

The UPS is heavy (see **8.0 - Specifications**). Take proper precautions when lifting or moving it.

2.2 What's Included

The Liebert GXT4 is shipped with the following items:

- Terminal Block Communication terminals
- Compact Disk with
 - Liebert MultiLink®
 - Configuration program
 - User manual (electronic version)
- Liebert IntelliSlot® Web card (IS-WEBCARD), factory-installed
- USB cable, one; 1.2 m (3.9 ft.)
- Rack mounting hardware including screws, handles, and rack slide kit
- Power Distribution Box, installed on Liebert GXT4
- Support base set, one
- Warnings, Safety Instructions booklet and WEEE recycling sheet (ISO 14001 compliance)



NOTE

The GXT4 External Battery Cabinet shipping package includes one battery cabinet, two spacers for tower configuration, one DC power cable and rack mounting hardware, including screws, handles and mounting rail kit.

2.3 Preparation for Installation

2.3.1 Installation Environment

Install the Liebert GXT4 indoors in a controlled environment, where it cannot be accidentally turned Off. Place it where air flows unrestricted around the unit. The installation location must be free of water, flammable liquids, gases, corrosives and conductive contaminants. Maintain an ambient temperature range of 0 to 32 - 104°F (0 – 40°C).



NOTE

UPS operation in sustained temperatures outside the range of 59° – 77°F (15 – 25°C) reduces battery life.

Installation Clearances

Maintain a clearance of at least 100 mm (4 inches) in the front and rear of the Liebert GXT4. Do not obstruct the air inlets on the front panel or rear panel of the UPS—blocking the air inlets reduces ventilation and heat dissipation, shortening the service life of the Liebert GXT4.

2.4 Install the Main Cabinet

The Liebert GXT4 may be installed in either a tower configuration or in a rack, depending on available space and use considerations. Determine the type of installation and follow the appropriate instructions in either **2.4.1 - Tower UPS Installation** or **2.4.2 - Rack Installation**.

2.4.1 Tower UPS Installation

To install the Liebert GXT4 as a tower:

1. Take the support bases out of the accessories bag (see **Figure 2-1**).

Figure 2-1 Support bases

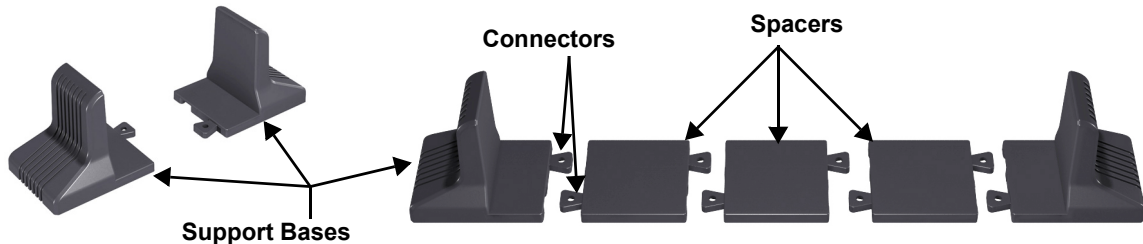

2. If optional Liebert external battery cabinets will be connected to the Liebert GXT4, take out the spacers shipped with the battery cabinet.
3. Connect the spacers and the support bases as shown in **Figure 2-1**. Each Liebert GXT4 needs two assembled support bases, one in the front and one in the rear.

4. Adjust the direction of the operation and display panel and logo on the Liebert GXT4.
 - a. Remove the front plastic bezel cover as shown in **Figure 2-2**.

Figure 2-2 Remove the front plastic bezel cover



- b. Pull the operation and display panel gently, rotate it 90 degrees clockwise and snap it back into position, as shown in **Figure 2-3**.

Figure 2-3 Rotate the operation and display panel

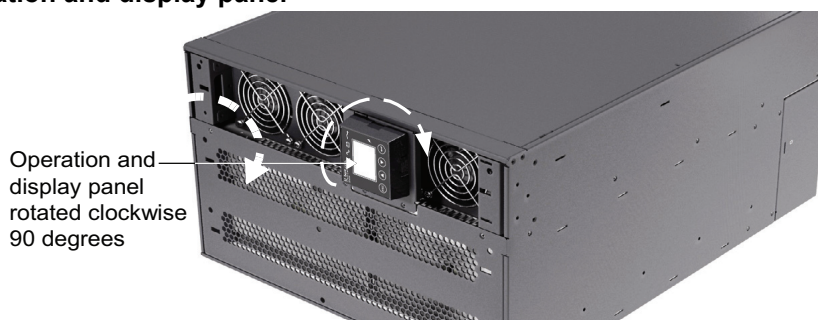

- c. Pull the logo on the front plastic bezel cover gently, rotate it 90 degrees clockwise and snap it back into position. The rotated front plastic bezel cover is shown in **Figure 2-3**.
 - d. Replace the front plastic bezel cover on the Liebert GXT4. At this point, the UPS operation and display panel and logo have been rotated 90 degrees clockwise, which provides upright viewing for users.
5. Place the Liebert GXT4 and any battery cabinets on the support bases. Each Liebert GXT4 needs two support assemblies.

2.4.2 Rack Installation

The Liebert GXT4 UPS and external battery cabinets (EBC), when installed in a rack enclosure, must be supported by a shelf or rack-mount rails. The Liebert GXT4 UPS and EBC units ship with all required hardware to allow rack-mount installation. Because different rack-mount options install differently, refer to the installation instructions provided with the rack mount kit being used.



CAUTION

The GXT4 is heavy; see **8.0 - Specifications**. The UPS must be installed as near the bottom of a rack as possible. If placed too high, it can make the rack top-heavy and prone to tipping over.

2.5 External Battery Cabinet Installation



WARNING

Risk of electric shock. Can cause injury or death.

Disconnect all local and remote electric power supplies before working within.

Ensure that the Liebert GXT4 is shut down and power has been disconnected before beginning any work on or in the unit.



CAUTION

The external battery cabinet(s) are heavy (see **Table 8-3**). Take proper precautions when lifting them.

Optional Liebert external battery cabinets may be connected to the UPS to provide additional battery run time. External battery cabinets are designed to be placed on one side of the UPS in a tower configuration or stacked beneath the UPS in a rack configuration.

Figure 2-4 External battery cabinets connected to GXT4

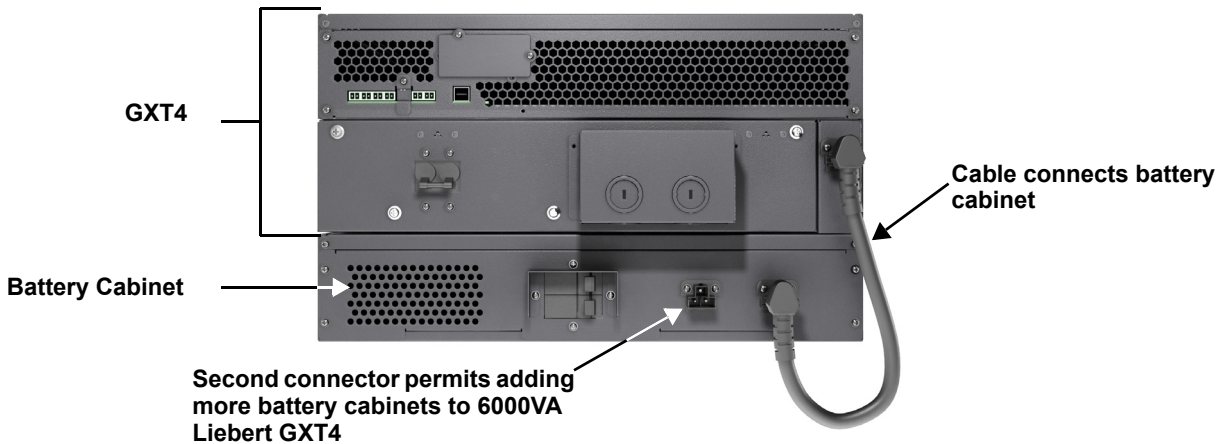

1. Inspect the external battery cabinet for freight damage. Report damage to the carrier and your local dealer or Emerson representative.
2. Optional rack-mount hardware is shipped with the external battery cabinet and may be installed at this time if desired.
 - Securing hardware and slide rails are sold separately. Please contact your local dealer or Emerson representative for these additional options and any assistance needed. Fasten the slides into position with the screws per the instructions included with the slide rails.
3. Use the enclosed support bases for the tower option to prevent tip-over. One additional set of support base extensions ships with each external battery cabinet.
4. Verify the External Battery Cabinet breaker is in the Off position.
5. Connect the supplied external battery cabinet cable to the rear of the external battery cabinet, then to the rear of the UPS.
6. Turn the External Battery Cabinet breaker to the On position.

7. Verify the circuit breaker on the External Battery Cabinet is in the On position.
8. Use the included configuration program or the LCD to program the UPS with the number of external battery cabinets connected. Instructions for the configuration program are in **5.2.1 - Configuration Program**.

The UPS is now equipped with additional backup battery run time. For approximate battery run times, refer to **Table 8-4**.

**NOTE**

When removing an external battery cabinet, the circuit breaker on the rear of the cabinet must be turned off before disconnecting the cable.

**NOTE**

If the UPS is to be shipped or stored for an extended time, the connector should be disconnected. This will minimize any standby current drain on the batteries and help attain their design life.

2.6 Connect Input/Output Power

The GXT4-5000RT208, Liebert GXT4-6000RT208 and Liebert GXT4-6000RTL630 are shipped with a power distribution box attached. The Liebert GXT4-8000RT208 and Liebert GXT4-10000RT208 are shipped with a cover plate over the power distribution connector.

Follow the instructions below for removal and installation.

**NOTE**

Do not operate the UPS with the power distribution box removed. To shut off all power to this box and to the load, utility input power must be disconnected.

2.6.1 Install the Power Distribution Box on 5000VA and 6000VA Models

1. Align the connectors and press the power distribution box onto the UPS.
2. Hold the box firmly against the UPS and tighten the captive screws except the one over the maintenance bypass breaker.
3. Turn the output and input breakers On.
4. Start the UPS according to startup instructions.
5. Verify that the UPS lamp is illuminated.
6. Turn the maintenance bypass breaker Off.
7. Insert the maintenance bypass interlock bracket behind the captive screw and tighten the screw.

**NOTE**

The maintenance bypass breaker interlock bracket must be installed behind the captive screw, and the screw must be tightened for the UPS to operate in inverter mode.

2.6.2 Remove the Power Distribution Box from 5000VA and 6000VA Models

1. Manually transfer the connected equipment to the internal bypass.
 - a. From the main menu select CONTROL, then press **Enter**.
 - b. Select TURN ON & OFF and press **Enter**.
 - c. Select TURN UPS BYPASS and press Enter. The UPS will transfer the connected loads to the internal bypass. (For help, refer to **4.4 - Manual Bypass**.)
 - d. Loosen the captive screw over the maintenance bypass breaker (see **Figure 2-5** for the breaker's location).
 - e. Turn the maintenance bypass breaker On.

NOTICE

The load is unprotected from disturbances in the power supply while the UPS is on bypass.

2. Turn the output and input breakers Off.
3. Loosen other captive screws until the power distribution box releases.
4. Remove the power distribution box from the UPS and set it aside.
5. Loosen the screws over the plastic cover for the connector on the rear of the panel.
6. Slide the plastic cover over the connector and tighten the screws.

Figure 2-5 Power distribution box removal from 5000VA and 6000VA models

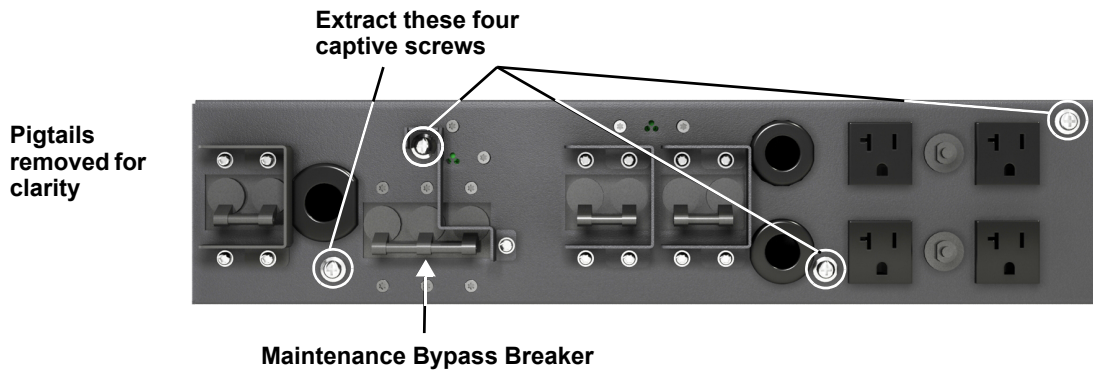

2.6.3 Remove the Power Distribution Cover from 8000VA and 10,000VA Models

! WARNING

Risk of electric shock. Can cause injury or death.

The UPS must be shut down or the load must be transferred to an external maintenance bypass before a power distribution box may be added, changed or removed.

If the UPS will be shut down, the connected load must be shut down (refer to **4.5 - Shut Down the GXT4**).

If the UPS will be transferred to maintenance bypass, it must be transferred to an external maintenance bypass. A maintenance bypass in the UPS frame must not be used.

Verify that the Liebert GXT4 is shut down and that all local and remote electric input power has been disconnected before beginning any work on or in the UPS.

1. Shut down the Liebert GXT4 (for help, refer to **4.5 - Shut Down the GXT4**).
 - a. From the Main Menu select CONTROL, press Enter, then select TURN ON & OFF.
 - b. Press the enter key.
 - c. Select TURN UPS OFF, then press Enter.
Power to the connected loads is now Off.
2. Turn the output and input breakers Off.
3. Support the power distribution box and remove the two screws at the top of the box.
4. Remove the cover or power distribution box from the UPS and set it aside.
5. If removing a power distribution box, carefully pull apart the power distribution box connector and the UPS connector.

Figure 2-6 Power distribution box removal from 8000VA and 10,000VA models

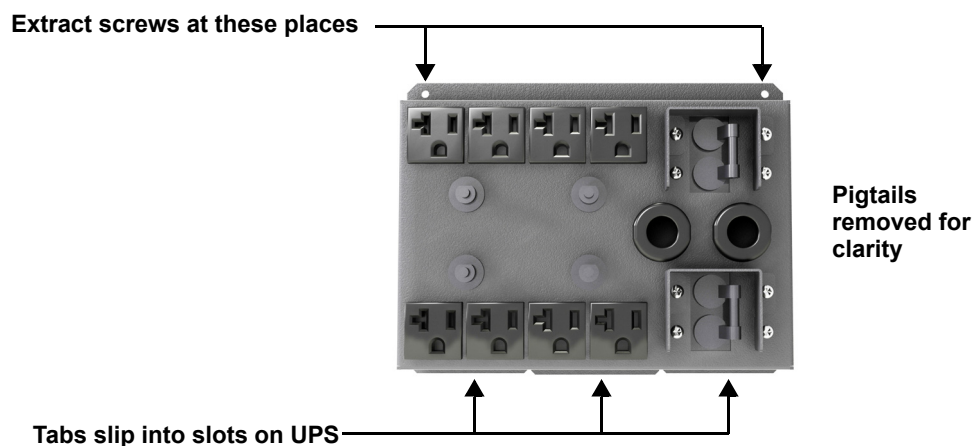

2.6.4 Install the Power Distribution Box on 8000VA and 10,000VA Models



WARNING

Risk of electric shock. Can cause injury or death.

The UPS must be shut down or the load must be transferred to an external maintenance bypass before a power distribution box may be added, changed or removed.

If the UPS will be shut down, the connected load must be shut down (refer to **4.5 - Shut Down the GXT4**).

If the UPS will be transferred to maintenance bypass, it must be transferred to an external maintenance bypass. A maintenance bypass in the UPS frame must not be used.

Verify that the Liebert GXT4 is shut down and that all local and remote electric input power has been disconnected before beginning any work on or in the UPS.

1. With the cover or distribution box removed, press the UPS and distribution box connectors together. Ensure that the connectors are fully seated.
2. Align the screw holes and press the power distribution box onto the UPS, making sure that the tabs at the bottom of the box fit into the slots on the UPS.
3. Attach the box to the UPS by installing screws into the two holes at the top of the box.
4. Tighten the screws.
5. Turn the output and input breakers On.
6. Start the UPS according to startup instructions.

2.6.5 Distribution Box Electrical Connections

Electrical connections are made through a removable power distribution box that attaches to the rear of the UPS.

- PD2-HDWR-MBS, PD2-001, PD2-002, PD2-003, PD2-004, PD2-005, PD2-006 and PD2-007 models fit the 5000 and 6000VA models of the Liebert GXT4
- PD2-L630 fits the GXT4-6000RTL630
- PD2-101, PD2-102, PD2-103, PD2-104, PD2-105, PD2-106, PD2-107, PD2-108, PD2-109, PD2-200, PD2-201, PD2-202, PD2-204 models fit the 8000 and 10,000VA models of the Liebert GXT4

The installer must provide an upstream branch circuit breaker. The input circuit breaker on the distribution box and the output circuit breaker on the rear of the power distribution box disconnect all power between the main cabinet and the distribution box.

Models equipped with a manual bypass breaker pass bypass power directly to the bypass breaker from the input terminal block. The input circuit breaker on the distribution box does not disconnect power from the manual bypass breaker.

Table 2-1 Branch circuit breaker ratings

Unit Rating	Maximum Breaker Rating
5000VA	D Type 30A Long Delay
6000VA	
8000VA	D Type 60A Long Delay
10,000VA	

Figure 2-7 Distribution box electrical connections diagram

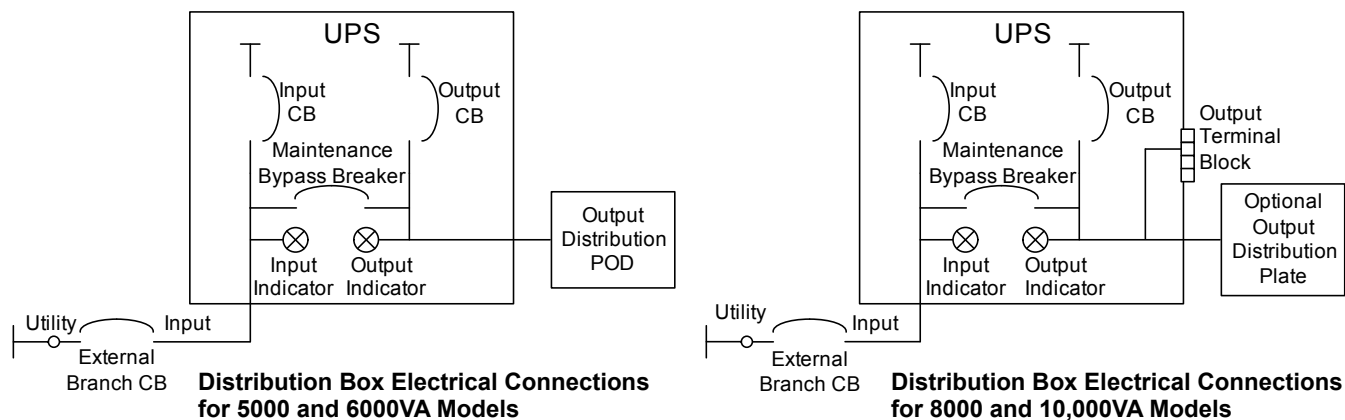

2.6.5.1 Terminal Block Connections



Conduit entry holes are provided on the rear and side of the box. Input and output wiring should not share the same conduit. Emerson recommends using strain relief when installing the wire.

Table 2-2 Electrical specifications



UPS Model	Recommended (Maximum) External Overcurrent Protection	Recommended Wire (Including ground wire) (75°C copper wire)	Maximum Wire Accepted by Terminal Block	Terminal Tightening Torque
GXT4-5000RT208 GXT4-6000RT208 GXT4-6000RTL630	30A	10AWG (4mm ²)	8AWG (6mm ²)	20 in-lb (2.26 Nm)
GXT4-8000RT208 GXT4-10000RT208	60A	6AWG (10mm ²)	4AWG (16mm ²)	

Figure 2-8 Terminal block connections

Liebert GXT4-5000 and 6000RT208

	L2	N	L1	L2	N	L1	
OUTPUT				INPUT			

Liebert GXT4-8000 and 10,000RT208

	L2	N	L1		L2	N	L1
OUTPUT				INPUT			



NOTE

1. Emerson recommends installing a UL489-approved breaker upstream of unit.
2. The installer must provide circuit breaker protection according to local codes. The mains disconnect should be within sight of the UPS or have appropriate an appropriate lock-out. Maintain service space around the UPS or use flexible conduit.
3. The installer must provide output distribution panels, circuit breaker protection or emergency disconnects according to local codes. Output circuits must not share a common conduit with any other wiring.
4. Liebert GXT4 models with a cord-connected input plug that is to be used as the power disconnecting device must be installed near a wall socket or outlet that is easily accessible per the National Electric Code / NFPA 70 requirements. Models that qualify are:
 - Liebert GXT4-6000RTL630 with standard POD

GXT4-5000RT208 and GXT4-6000RT208 fitted with the optional POD's PD2-001, PD2-002, PD2-003, PD2-004, PD2-005, PD2-006 and PD2-007.

2.7 IT Power System Configuration

1. Remove screws on the IT Power System Access Cover as shown in **Figure 3**.
2. Disconnect the connectors as shown in figure.
3. Install IT Power System Access Cover and screws.

Figure 3 Remove cover from IT Power System Connectors compartment

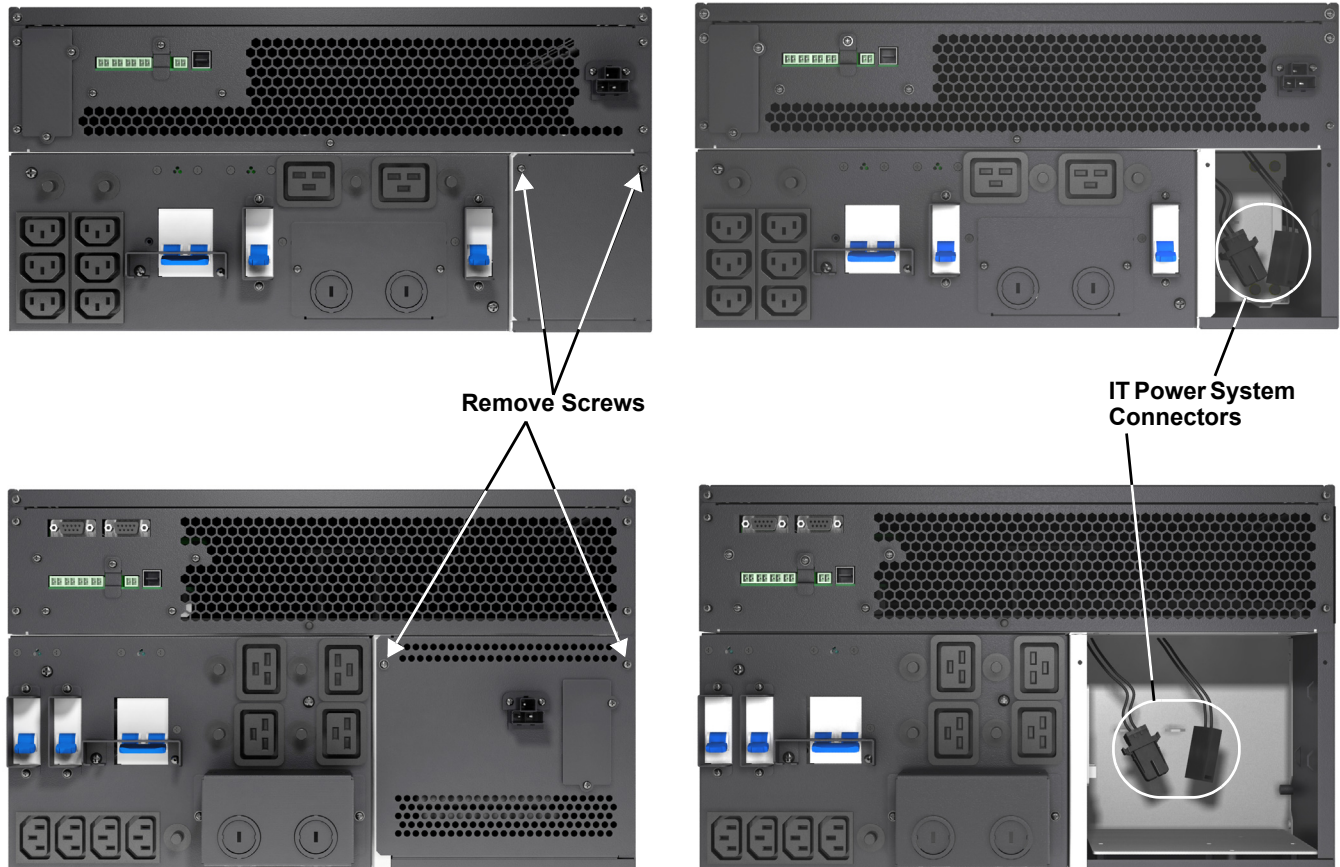

Page intentionally left blank.

3.0 Operation and Display Panel

This chapter describes the Liebert GXT4 controls, particularly the operation and display panel on the front of the Liebert GXT4. The panel has four control buttons, seven LED indicators and a liquid crystal display (LCD), as shown in **Figure 3-1**.

Figure 3-1 Operation and display panel

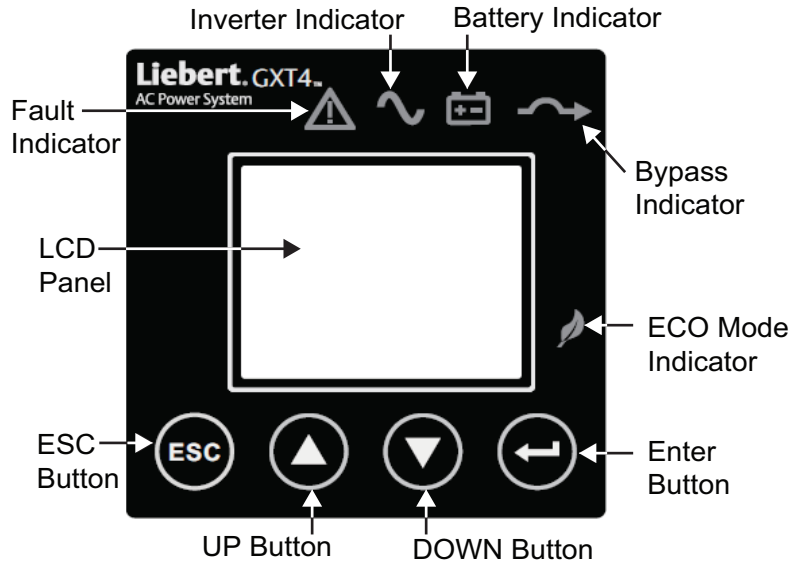

3.1 LED Indicators

The seven LED indicators on the front of the operation and display panel are:

- Inverter
- Battery
- Bypass
- ECO Mode
- Fault

Figure 3-1 shows the indicators' locations; their descriptions and functions are shown in **Table 3-1**.

Table 3-1 LED indicators

LED Indicators	LED Color	Description
Inverter	Green	On when the inverter is supplying power
Bypass	Amber	On when the load is supplied by the mains through automatic/manual bypass
Battery	Amber	On when the load is supplied by the battery
Fault	Red	On when an error has occurred within the UPS
ECO Mode	Green	On when the UPS is in ECO Mode

3.2 Control Buttons

The four control buttons on the front of the operation and display panel are:

- ESC
- Up
- Down
- Enter

Figure 3-1 shows the buttons' locations; their descriptions and functions are shown in Table 3-2.

Table 3-2 Control buttons

Control Buttons	Description
ESC Button	Pressing this button returns to the previous menu or aborts any change in the input data field before confirming.
Up Button	Pressing this button can move the cursor up or increase the value displayed in the input data field. When a menu is displayed on several screens, pressing the button can scroll up.
Down Button	Pressing this button can move the cursor down or decrease the value displayed in the input data field. When a menu is displayed on several screens, pressing the button can scroll down.
Enter Button	Pressing this button can enter the next level menu or confirm the parameter setting value.

3.3 LCD

The LCD panel shows the UPS status and enables changes to the UPS settings by assisting in navigating through the Liebert GXT4's menu (see 3.4 - Menu Structure).

3.4 Menu Structure

The menu structure of the LCD is shown in **Figure 3-2**.

Figure 3-2 Menu structure

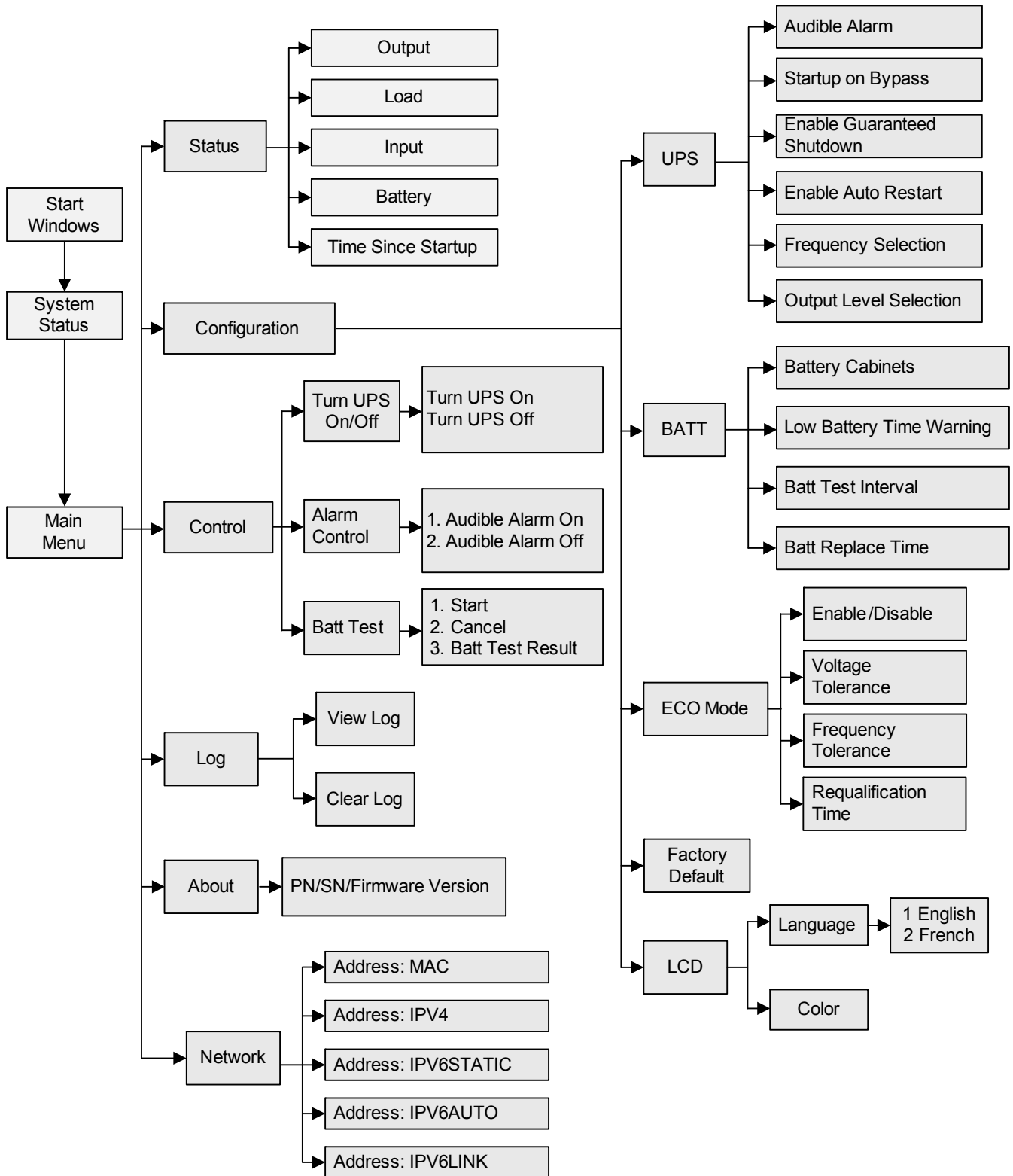

3.4.1 Startup Screen

When the Liebert GXT4 is starting up, it initiates a self-test and displays the screen shown in **Figure 3-3** for about 10 seconds.

Figure 3-3 Startup screen



After about 10 seconds, the LCD shows one of the On screens in **Figure 3-4**; the screen shown depends on whether input power is available.

Figure 3-4 Startup screens

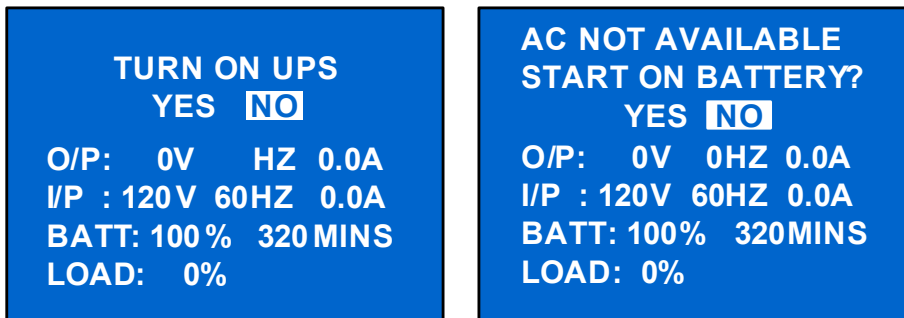

No.	Description
1	Input power is available.
2	Input power is not available.

To turn On the UPS, press either the Up or Down button to select YES and press the Enter button. The UPS will start up, the LCD will display *UPS STARTING* and then *START SUCCESSFUL* after the UPS is turned On, as shown in **Figure 3-5**.

Figure 3-5 Starting and Start Successful screens

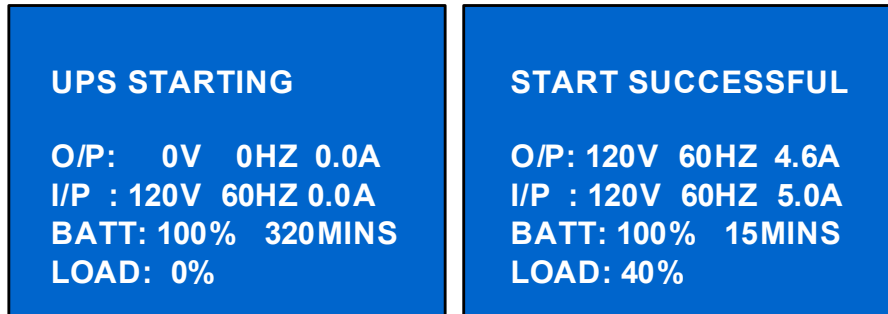

3.4.2 Default Screen

Press any button in the START SUCCESSFUL screen to enter the default interface, shown in **Figure 3-6**.



NOTE

Values shown in the default screen will vary depending on installation and configuration.

In the default screen, the LCD shows the UPS model, output parameters, input parameters, battery capacity with run time estimate and load percentage. The UPS operation mode (online /inverter, ECO, Battery or Bypass) will be indicated by the LED indicators.

If no control button (ESC, Up, Down, Enter) is pressed for 2 minutes, the LCD will enter the screen saver mode (backlight turns off). It will remain off until a control button is pressed.

Figure 3-6 Default screen

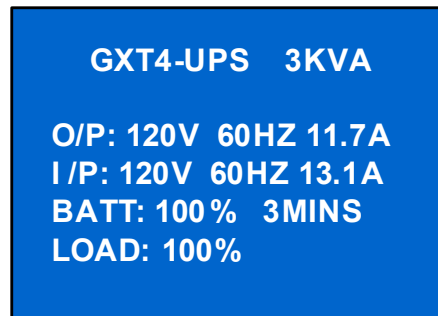

3.4.3 Main Menu Screen

Press the Enter button in the default screen to enter the MAIN MENU screen, as shown in **Figure 3-7**.

To select a submenu, press the Up or Down button to move the cursor to the required item, then press the Enter button to enter its submenu or set its parameter.

Figure 3-7 Main Menu screen

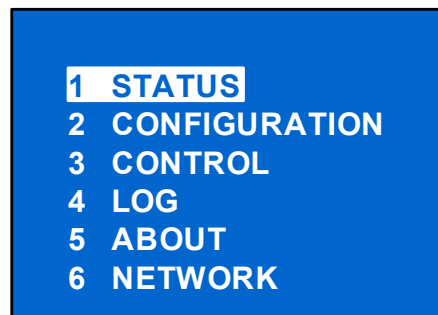

STATUS Screen

In the MAIN MENU screen, select *STATUS* to enter the Status Screen, displaying OUTPUT, LOAD, INPUT, BATTERY and TIME SINCE STARTUP, as shown in **Figure 3-8**.

Figure 3-8 Status screens

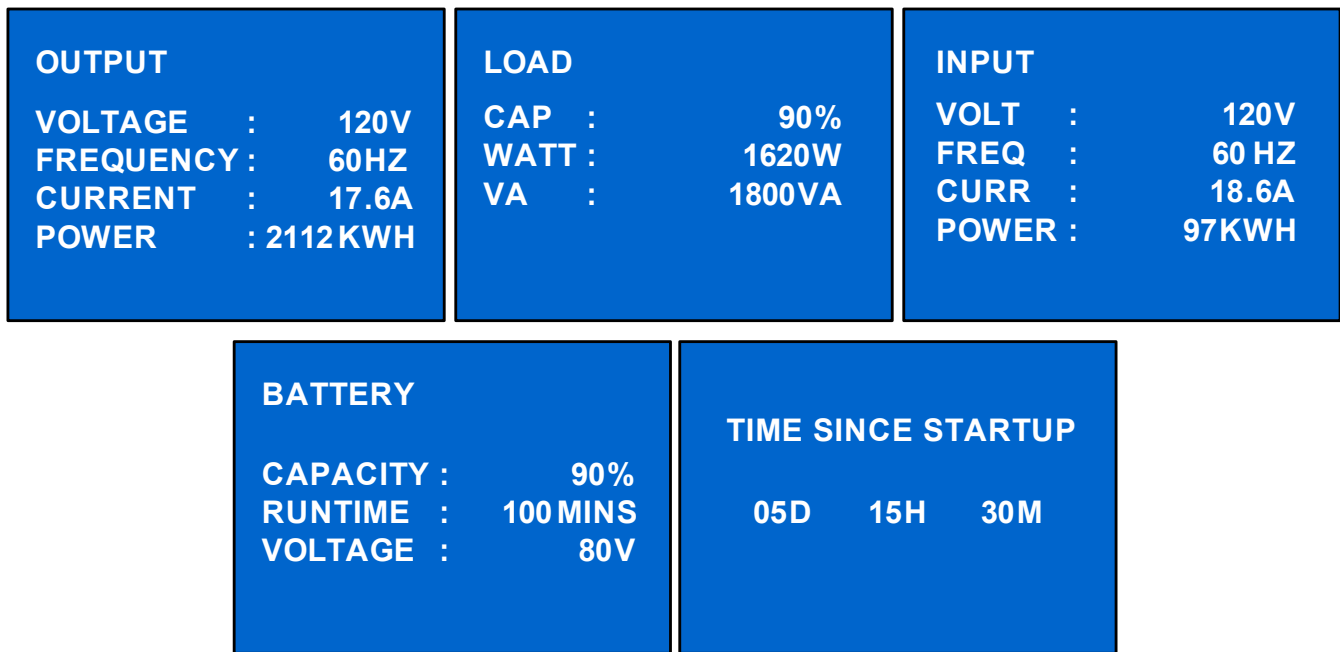

CONFIGURATION Screen

Select *MAIN MENU > CONFIGURATION* to enter the Configuration menu. This menu has seven submenus, as shown in **Figure 3-9**.

In the CONFIGURATION screen, press the Up or Down button to move the cursor to the required item, then press the Enter button to enter a submenu or set its parameters.

Figure 3-9 CONFIGURATION screen

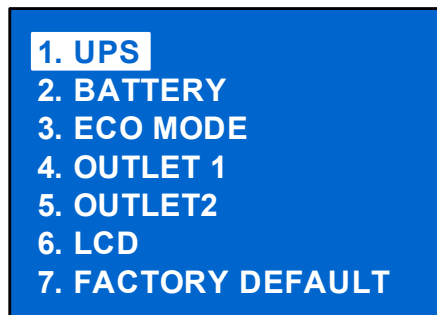

UPS Screen

Select *MAIN MENU > CONFIGURATION > UPS* to enter the UPS screen. This menu has six screens, as shown in **Figure 3-10**.

Press the Up or Down button to move the cursor to the required item, and press the Enter button to confirm the settings.

Figure 3-10 UPS screens

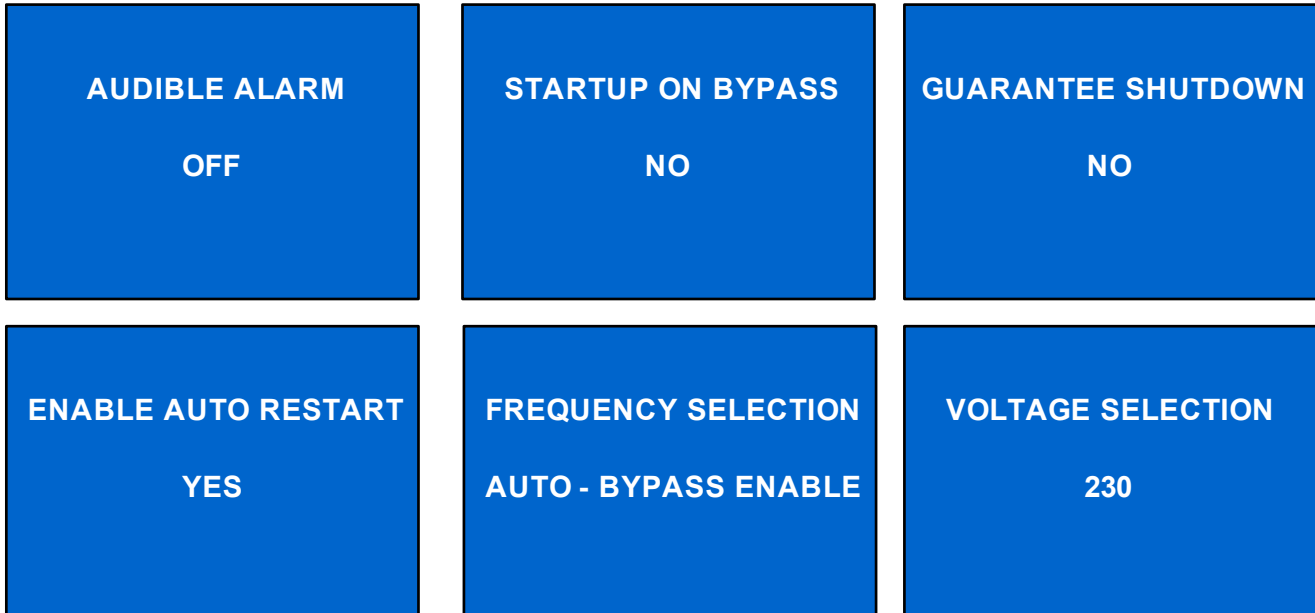

Battery Screen

Select *MAIN MENU > CONFIGURATION > BATTERY* to enter the BATTERY screen. This menu has four screens, as shown in **Figure 3-11**.

Press the Up or Down button to increase or decrease the value of the settings, and press the Enter button to confirm it.

Figure 3-11 Battery screen

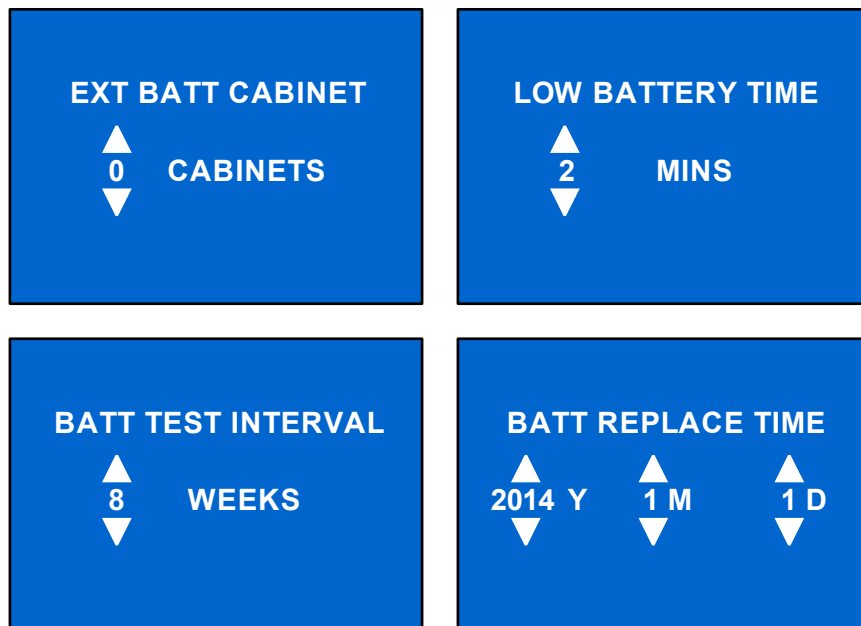

ECO Mode Screens

Select *MAIN MENU* > *CONFIGURATION* > *ECO MODE* to enter the ECO MODE screens, as shown in **Figure 3-12**.

Press the Up or Down button to move the cursor to the required item, and press the Enter button to confirm the settings.

Figure 3-12 ECO Mode screen

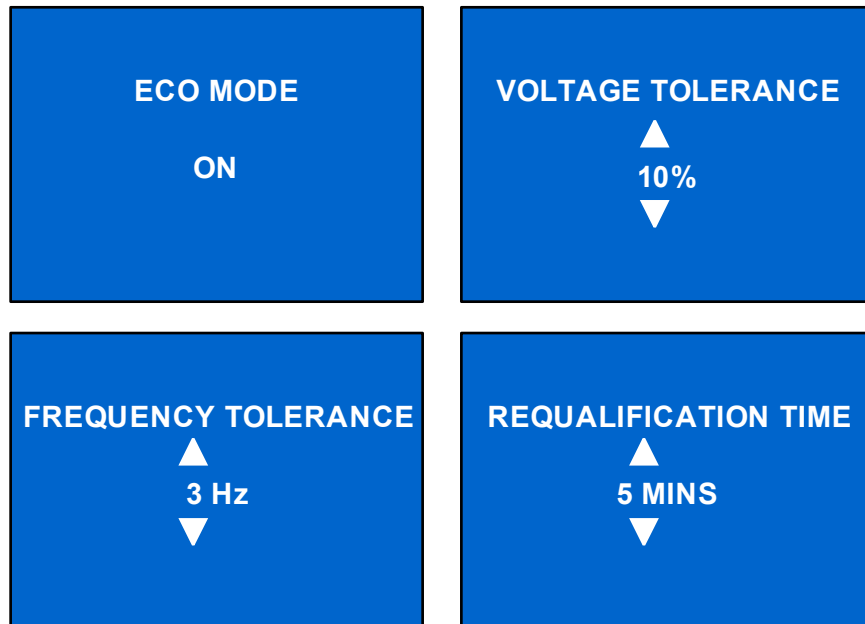

No.	Description
1	Outlet control is on.
2	Outlet control is off.

LCD screen

Select Main Menu -> **2 CONFIGURATION** -> **6 LCD** to enter the LCD screen. This menu has two submenus, LANGUAGE and COLOR, as shown in **Figure 3-13**.

Figure 3-13 LCD screen

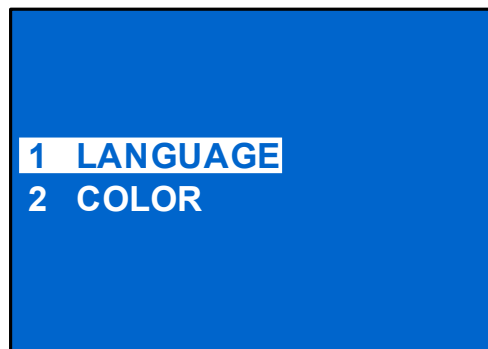

Select *1 LANGUAGE* and press the Enter button to enter the LANGUAGE screen, as shown in **Figure 3-14**.

The Liebert GXT4 is capable of supporting multiple languages. For the list of supported languages and instructions on how to upload them, refer to the Configuration Program user manual on the included CD.

Figure 3-14 Language screen



Select '**2 COLOR**' and press the Enter button to enter the COLOR screen, as shown in **Figure 3-15**.

Figure 3-15 Color screen

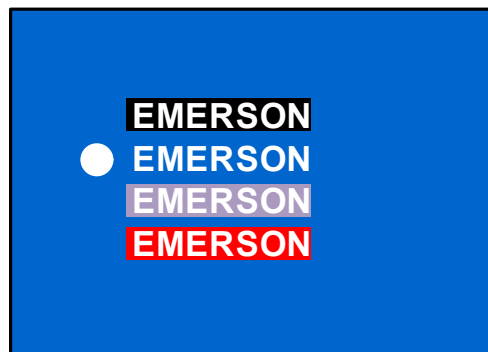

FACTORY DEFAULT screen

Select *MAIN MENU -> 2 CONFIGURATION -> 7 FACTORY DEFAULT* to enter the FACTORY DEFAULT screen, as shown in **Figure 3-16**.

Figure 3-16 Factory Default screen

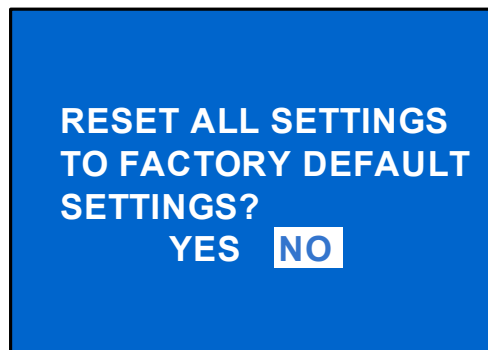

Control Screen

Select *MAIN MENU* -> **3 CONTROL** to enter the CONTROL screen. This screen has three submenus, TURN ON & OFF, ALARM CONTROL and BATT TEST, as shown in **Figure 3-17**.

In the CONTROL screen, press the Up or Down button to move the cursor to the required item, and press the Enter button to enter its submenu.

Figure 3-17 Control screen



TURN ON & OFF screen

Select *MAIN MENU* -> **3 CONTROL** -> **1 TURN ON & OFF** to enter the TURN ON & OFF screen. This screen shows one of two displays, TURN ON UPS and TURN OFF UPS, depending on the state of the UPS, as shown in **Figure 3-18**.

Figure 3-18 Turn UPS On or Off screen

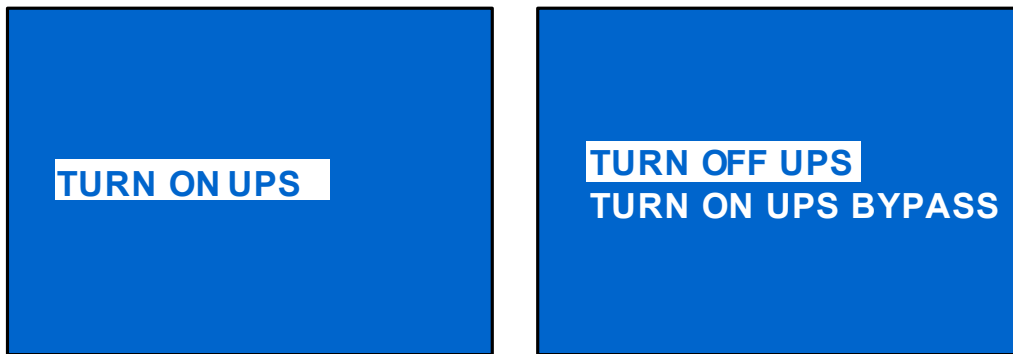

1

2

No.	Description
1	UPS is off.
2	UPS is on.

ALARM CONTROL screen

Select *MAIN MENU* -> 3 *CONTROL* -> 2 *ALARM CONTROL* to enter the ALARM CONTROL screen, as shown in **Figure 3-19**. This section allows active audible alarms to be silenced. To completely turn off the audible alarm, refer to *CONFIGURATION > UPS* as shown in **Figure 3-10**.

Figure 3-19 Alarm Control screen



BATT TEST screen

Select *MAIN MENU* -> 3 *CONTROL* -> 3 *BATT TEST* to enter the BATT TEST screen, as shown in **Figure 3-20**.

Figure 3-20 Batt Test screen

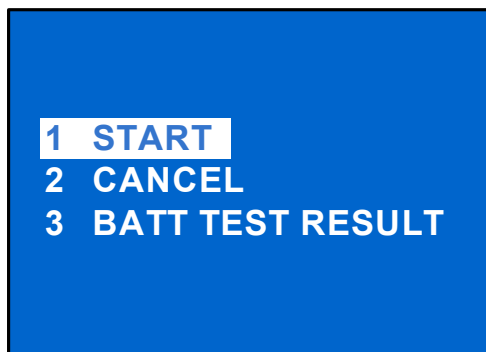

Log Screen

Select *MAIN MENU* -> 4 *LOG* to enter the LOG screen. This screen has two submenus, *VIEW LOG* and *CLEAR LOG*, as shown in **Figure 3-21**.

Figure 3-21 Log screens

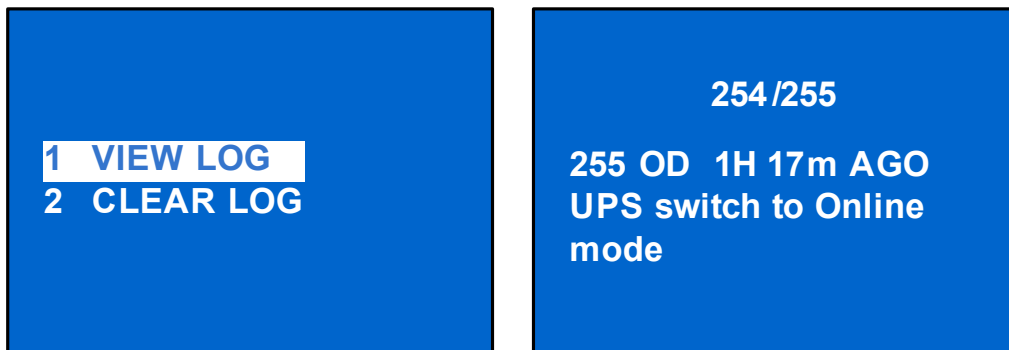

CLEAR LOG Screen

Select *MAIN MENU* > *LOG* > *CLEAR LOG* to enter the CLEAR LOG screen, as shown in **Figure 3-22**.

Press the Up or Down button to move the cursor to the required item. Press the Enter button to confirm the settings.

Figure 3-22 Clear Log screen

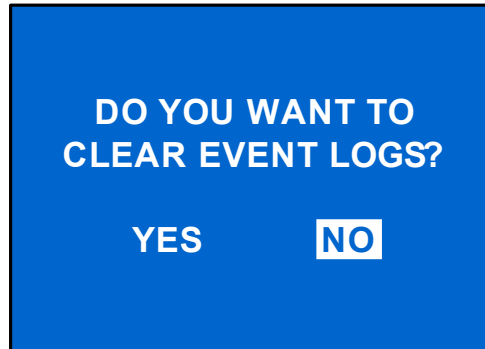

ABOUT Screen

Select *MAIN MENU*> *ABOUT* to enter the ABOUT screen, as shown in **Figure 3-23**. The ABOUT screen displays UPS model, serial number, software version and hardware version.

Figure 3-23 About screen

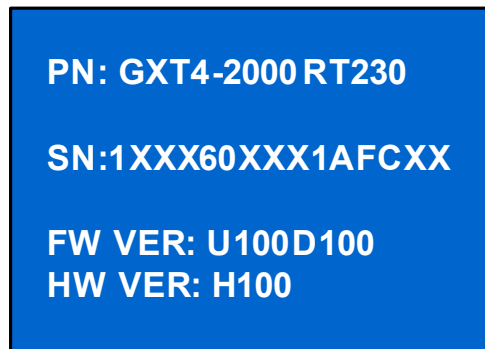

Network

Select *MAIN MENU>NETWORK* to enter the NETWORK screen.

The NETWORK screen displays the MAC address and the IPv4 IP address. If the Liebert GXT4 is fitted with an optional Liebert IntelliSlot® Web card (Liebert IS-WEBCARD), the screen will display IPv6 IP address settings (IPv6 requires configuration), as shown in **Figure 3-24**.

Figure 3-24 Network screens

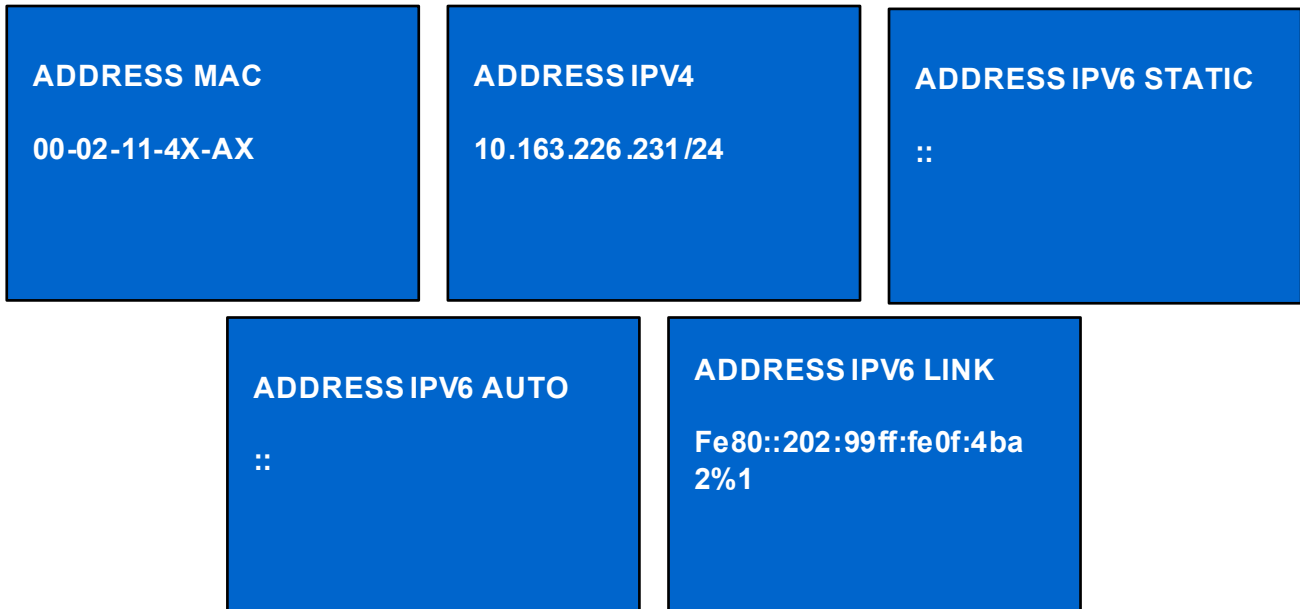

3.4.4 Prompt List

A prompt screen is displayed during the operation of the system to alert you to certain conditions and/or to require your confirmation of a command or other operation. See **Table 3-3** for the prompts and meanings.

Table 3-3 System prompts and meanings

Prompt	Meanings
Mains Power Restored	The mains power returns and the UPS transfers back to mains (AC) mode.
UPS Return From A Low Battery Condition	The UPS transfers back to mains (AC) mode from battery low mode.
UPS Return From Battery Mode	The UPS transfers back to mains (AC) mode from battery mode.
UPS Self Test Successful	The UPS self-test is successfully performed.
UPS Shutdown Command Received	The UPS shut down was initiated through communication.
UPS Turn Off	The UPS shuts down and has no output power.
UPS Turn On	The UPS starts up successfully and supplies protected power to the load.
UPS Shutdown Process Had Been Cancelled	The shutdown command sent through Liebert MultiLink or SNMP card to the UPS is canceled,
ECO Mode Enabled	The UPS is configured to ECO mode operation,
ECO Mode Disabled	The UPS is configured to Online mode, supplying protected power to the load through the inverter.
UPS Internal Temperature Return To Normal	The internal temperature of the UPS recovers to normal range.
UPS Load Return From Overload	The loads are reduced, and the UPS recovers to normal state from overload.
Load On Inverter	The inverter is on and supplies protected power to the load.
Load On ECO Bypass	The UPS is on ECO mode; the mains is supplying power to the load directly to reduce energy usage.
Bypass Power Restored	The bypass power recovered and the UPS can now transfer to bypass.

3.4.5 Warning List

All UPS warning messages are described in **Table 3-4**.

Table 3-4 Warning list

Warning	Description
Mains Power Not Available	The mains power is not available, or it cannot satisfy the input requirements for the UPS to operate from mains power
UPS Batteries Low And Exhausted Soon	The battery capacity is low and will be exhausted soon
UPS Has Switched To Battery Mode	The mains power is abnormal or the PFC side is faulty, the UPS transfers back to Battery mode
Load On Bypass	The UPS transfers to Bypass mode, at this point, the input mains power supplies power to the load directly, and the load is not protected
Input Power Wiring Error	L-N line reverse or PE not connected.
Bypass Power Not Available	The bypass power is not available, or it cannot satisfy the requirements for the UPS transfers to bypass
UPS Maintenance Bypass Output	The UPS transfers to maintenance bypass.
AC input not qualified, cannot start UPS	The utility power is not qualified, the inverter cannot be powered up
Output disabled	REPO terminal connect error

3.4.6 Fault List

All UPS fault messages are described in **Table 3-5**.

Table 3-5 Fault list

Fault	Description
UPS Self-Test Failed	The battery is bad or weak or not connected.
UPS Overload	The UPS is overloaded.
Inverter Out Of Order	The inverter has failed.
Battery Weak/Bad	The battery is bad or weak.
Output Short Circuit	The output connection is short-circuited.
DC Bus Overvoltage	The DC bus is faulty.
UPS Overtemperature	Overtemperature occurs to the UPS and the UPS will transfer to Bypass mode.
Charger Out Of Order	The charger has failed.
Fan Out Of Order	At least one fan is failed.
DC Bus Discharge Fail	DC-DC failure occurs.
Rectifier Out Of Order	Rectifier failure occurs.

If a fault occurs, the UPS automatically switches to Bypass Mode. The original operating mode will be maintained only in the case of a battery disconnection fault. The fault message alternates with UPS Mode once a second, the red fault indicator on the operation and display panel lights up and the alarm sounds continuously.

If a fault occurs:

1. Enter the ALARM CONTROL screen (see **Figure 3-19**), and select *AUDIBLE ALARM ON* or *AUDIBLE ALARM OFF* to switch the alarm On or Off.
2. Enter the EVENT LOG screen (see **Figure 3-21**), and select *VIEW LOG* to view the entire Event log.



NOTE

There will be a short delay before the EVENT LOG screen displays the historical fault log to allow the log to load.

Page intentionally left blank.

4.0 Operation

This section describes checks to be made before starting the UPS, how to start the UPS, manual battery test, manual bypass, shutting down the UPS and disconnecting mains power from the UPS.



NOTE

The Liebert GXT4's battery has been fully charged before delivery, but some charge will be lost during storage and shipping. To ensure that the battery has adequate reserve power to protect the connected load, charge the battery for 5 hours before putting the UPS into service.

4.1 Startup Checklist for the Liebert GXT4

Before starting the UPS, perform these checks:

- ___ 1. Check that the input plugs and loads are connected properly and reliably.
- ___ 2. Check that the battery cable is connected properly.
- ___ 3. Check that the communication cables are connected properly.

4.2 Starting the UPS

1. Plug the UPS into the appropriate AC outlet.
2. Close the input breaker on the rear of the unit.
3. The UPS will begin the startup sequence once AC power is present.



NOTE

The UPS will sound an audible alarm, this is normal.

4. On the LCD, press either the Up or Down button once, then press the Enter button to turn On the UPS. *The UPS will sound the audible alarm again as the output receptacles are now being powered by the internal bypass, then will sound one more time as the inverter powers the connected equipment.*
5. Check the LCD and LED indicators to ensure that the UPS is operating normally.
6. Check the load percentage on the default screen to ensure that the connected equipment is not exceeding the UPS's rated capacity.

The UPS is now providing conditioned and protected power to the connected equipment.

4.3 Manual Battery Test

To initiate a manual battery test, select *MAIN MENU > CONTROL>BATT TEST>START*.

- If the battery test results show *FAILED*, allow the UPS to recharge the batteries for 24 hours.
- Retest the batteries after 24 hours of charging.
- After the batteries have been retested, if the battery test still shows *FAILED*, contact your local Emerson® representative or Emerson Network Power Channel Support.

4.4 Manual Bypass

To manually transfer the connected equipment to the internal bypass:

1. From the main menu select Control then press enter.
2. Select *TURN ON & OFF* and press Enter.
3. Select *TURN UPS BYPASS* and press Enter. The UPS will transfer the connected loads to the internal bypass.

If the internal bypass is not available because of input power problems, pressing this button once will be ignored. Bypass operation is indicated by an audible alarm and illuminated amber Bypass indicator. (If other indicators are illuminated, refer to **7.0 - Troubleshooting**.)

4.5 Shut Down the GXT4

To shut down the UPS from the LCD:

1. From the Main Menu select *CONTROL*, press Enter, then select *TURN ON & OFF*.
2. Press the Enter key.
3. Select *TURN UPS OFF*, then press Enter. Press either the Up or Down button to move the cursor to confirm the turn off command and press Enter. *The UPS will sound an audible alarm; this is normal.*
4. Power to the connected equipment is now Off.

The UPS display will still be illuminated because the batteries are still being charged. The UPS may now be disconnected from AC power, and the UPS will completely shut down in approximately 15 seconds.

4.6 Disconnecting Input Power from the GXT4

1. After the UPS has been shut down as detailed in **4.5 - Shut Down the GXT4**, disconnect the input cable from the wall socket.
2. Wait 30 seconds and verify that all indicators have turned Off and the fan has stopped; this indicates that the power-off is complete.
3. Turn the external battery cabinet breaker switch to the Off position if the UPS has an external battery cabinet.

After powering Off the UPS, the UPS ceases output and the load is powered Off.

4.7 Maintenance Bypass

Maintenance Bypass Mode is used when maintenance or replacement is required. To place the unit in Maintenance Bypass:

1. Place the UPS on internal bypass. This may be done by either of the following methods:
 - a. Refer to **4.4 - Manual Bypass**.
 - b. Slide the bracket away from the manual bypass breaker on the rear of the UPS. This requires loosening the captive screw and sliding the bracket up and away from the Manual Bypass breaker.
2. Move the Manual Bypass breaker on the rear of the UPS to the bypass position. This requires loosening the captive screw and sliding the bracket up and away from the Manual Bypass breaker.

5.0 Communication

This section describes the communication ports on the rear of the UPS:

- Liebert IntelliSlot® port
- USB port (standard B-type)
- Terminal Block Communication



CAUTION

To maintain safety (SELV) barriers and for electromagnetic compatibility, signal cables should be segregated and run separate from all other power cables.

5.1 Liebert IntelliSlot Communication Cards

The Liebert IntelliSlot port accepts four optional cards:

- Liebert IntelliSlot Web Card (IS-WEBCARD)
- Liebert IntelliSlot Relay Card (IS-RELAY)
- Liebert IntelliSlot MultiPort Card (IS-MULTIPORT)
- Liebert IntelliSlot Unity Card (IS-UNITY-DP)

The Liebert IntelliSlot Web Card provides SNMP monitoring and control of the UPS across the network.

The Liebert IntelliSlot Relay Card provides dry contact relay outputs for custom-wired applications and delivers support for Liebert MultiLink® shutdown software.

The Liebert IntelliSlot MultiPort Card provides four sets of contacts for support of up to four computers that have Liebert MultiLink installed.

The Liebert IntelliSlot Unity Card provides SNMP and/or RS-485 monitoring of the UPS across the network and/or building management system. The Liebert IntelliSlot UNITY card also enables monitoring external temperature, humidity and contact closure inputs using external sensors.

Follow instructions provided with the Liebert IntelliSlot card to configure Liebert MultiLink®, the UPS or any additional ancillary product for the Liebert GXT4. These instructions are available at:

multilink.liebert.com

5.1.1 Liebert MultiLink

Liebert MultiLink monitors the UPS continuously and can shut down the computer or server in the event of an extended power failure. Liebert MultiLink can also be configured to shut down the UPS.

Liebert MultiLink can communicate with the UPS via the USB port, RS232 port, contact closures via terminal block or over the network via SNMP using the Liebert IS-WEBCARD. An optional Liebert MultiLink license kit permits shutting down multiple computers that are protected by the UPS.

For more information about the Liebert IntelliSlot SNMP Card, Liebert IntelliSlot Web Card and Liebert MultiLink License Kits, visit the Liebert Web site (www.liebert.com) or contact your local Emerson® representative.

5.2 USB Port Communication

The standard B-type USB port is used to connect the UPS and network server or other computer system using Liebert MultiLink®.

A standard B-type USB port is provided to allow connection to a computer or network server. The USB port can be used to communicate with the Liebert GXT4 configuration program (see section 5.2.1 - **Configuration Program** for details) or Liebert MultiLink (refer to 5.1.1 - **Liebert MultiLink** for description) that is provided on the CD that is included with the UPS.

5.2.1 Configuration Program

The configuration program is on the Liebert GXT4 CD and can be used instead of making configuration setting changes from the LCD panel. The configuration program communicates to a computer running a Microsoft® Windows® operating system via the included USB cable.

For most users, the factory default settings are adequate. This section give a brief overview of the features and parameters that are available for modification, as well as the factory default settings. Should any changes be necessary, refer to the Configuration Program User Manual that is located on the included CD for further details.

The configuration program allows these features of the Liebert GXT4 to be changed:

- Change and set the display language
- Enable/Disable Auto-Restart (default is Enable)
- Select frequency converter operation with a fixed output frequency of 50Hz or 60Hz, bypass disabled (default is Auto-Select with bypass enabled)
- Set the Low Battery Warning alarm time from 2 to 30 minutes (default is 2 minutes)
- Enable/Disable the Auto-Battery test (default is Enable)
- Enable/Disable Auto-Restart after removing Remote shutdown (default is Disable)
- Set the wiring mode of Remote shutdown (default is normally open)
- Set the Auto-Enable output after remote shutdown (default is Disable)
- Set the Auto-Battery test to 8, 12, 16, 20, or 26 weeks (default is 8 weeks)
- Select the number of external battery cabinets connected to the UPS to adjust the remaining run time calculated by Emerson® software products (default is zero)
- Select one of multiple output voltages to match various voltages (see **Table 5-1**).

Table 5-1 Output voltage option

UPS Model	FactoryDefault Setting	Output Voltage Option
GXT4-6000RTL630	208 VAC	200V, 208V, 220V, 230V, 240V
GXT4-5000RT208 GXT4-6000RT208 GXT4-8000RT208 GXT4-10000RT208	208/120 VAC	200/100V, 208/120V, 220/110V, 230/115V, 240/120V, 220/127V

NOTICE

The output voltage settings cannot be changed while the UPS is On and powering connected loads.

**NOTE**

Programming the output voltage of the Liebert GXT4-5000RT208, GXT4-6000RT208, GXT4-8000RT208, and GXT4-10000RT208 models to 220/110VAC automatically derates both the VA and Watt ratings to 90% of the units ratings and programming the output voltage to 200/100VAC automatically derates both the VA and Watt ratings to 80% of the units ratings (refer to **9.0 - Specifications** for the VA and Watt ratings)

**NOTE**

- This program is compatible with UPS models beginning with 'GXT4,' as in 'GXT4-3000RT230.' It is not compatible with earlier versions of the Liebert GXT UPS.
- A computer running Microsoft® Windows 2000®, Windows XP®, Windows Vista®, Windows 7 or Windows 8 is required to set up and run the configuration program.

5.3 Terminal Block Communication

The Terminal Block includes eight pins, as shown in **Figure 5-1**.

Figure 5-1 Terminal-block communication pin layout

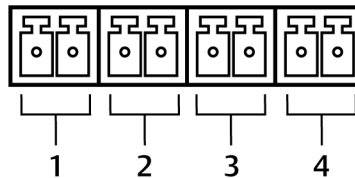

No.	Description
1	Low battery warning
2	On-battery warning
3	Any mode shutdown
4	Battery mode shutdown

5.3.1 Any Mode Shutdown

The purpose of Any Mode Shutdown is to shut down the UPS output by turning Off the rectifier, inverter and static switch so that there is no power to the loads.

Any Mode Shutdown can be operated locally or remotely:

- Local Any Mode Shutdown can be performed by shorting the pins in terminal 3 for the UPS-models ending in RT208, and pins1 and 2 for the GXT4-6000RTL630 model.
- Remote Any Mode Shutdown can be performed using a switch mounted at a remote location and connected to the pins in terminal 3 for the UPS-models ending in RT208, and pins1 and 2 for the GXT4-6000RTL630 model.



NOTE

Remote Power Off will be performed either by NO or NC contact of Any Mode Shutdown, depending on the settings in the configuration program.

A current-limited source for this optocoupler (+12 VDC, 50 mA) will be available from the UPS.

The connection to the UPS for remote connection will be via terminal block connector.

Any Mode Shutdown wiring must conform to all national, regional and local wiring regulations.



WARNING

When the Auto-Enable output option is selected and the UPS output is disabled using Any Mode Shutdown, the Liebert GXT4's output can turn On automatically and without warning if the connection is changed.

5.3.2 Battery Mode Shutdown

Battery Mode Shutdown permits shutting down the UPS by turning Off the rectifier, inverter and static switch so that there is no power to the load when the UPS is On Battery. The auxiliary power for the UPS will still be active.

Battery Mode Shutdown can be performed locally or remotely:

- Local Battery Mode shutdown can be performed by shorting the pins in terminal 4 for the UPS-models ending in RT208, and pins3 and 4 for the GXT4-6000RTL630 model.
- Remote Battery Mode Shutdown can be performed using a switch mounted in a remote location and connected to the pins in terminal 4 for the UPS-models ending in RT208, and pins 3 and 4 for the GXT4-6000RTL630 model.



NOTE

Remote Power Off will be performed by NO contact.

A current-limited source (+12 VDC, 50 mA) will be available from UPS.

The connection to the Liebert GXT4 for remote connection will be via terminal block connector.

Battery Mode Shutdown wiring must conform to all national, regional and local wiring codes and laws.

This signal must last for 1.5 seconds or longer.

A battery shutdown signal will not cause an immediate shutdown. It will start a 2-minute shutdown timer. This timer cannot be stopped once triggered. If the mains power returns during this countdown, the Liebert GXT4 will still shut down and must remain shut down for 10 seconds. Whether the UPS turns back On when the power is restored depends on the auto-restart setting.

5.3.3 On Battery

On Battery signal is a Normally Open (NO) dry contact. When the UPS is supplying output power from the battery this dry contact will be closed.

5.3.4 Low Battery

Low Battery signal is a Normally Open (NO) dry contact. When the UPS is supplying output power from the battery and has reached the Low Battery Warning time selected in the configuration program, this dry contact will be closed.



NOTE

The rated values for the dry contacts for the On Battery and Low Battery signals are:

- Rated Voltage: 30 V (AC or DC)
- Rated Current: 300 mA

5.4 Remote Emergency Power Off—GXT4-6000RTL630

The UPS is equipped with a Remote Emergency Power Off (REPO) connector.

The user must supply a means of interfacing with the REPO circuit to allow disconnecting the UPS input feeder breaker to remove all sources of power to the UPS and connected equipment to comply with national and local wiring codes and regulations.

Figure 5-2 REPO switch connection diagram

UPS ships with REPO jumper installed allowing the UPS to operate

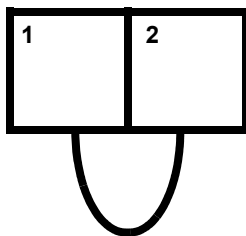

Normally closed switch system
(fail-safe)

Opening the REPO connection will disable the UPS. Manual restart using the front panel is required after the REPO connection is closed again.

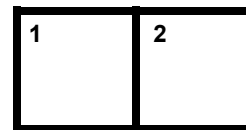

CAUTION

To maintain safety (SELV) barriers and electromagnetic compatibility, signal cables should be shielded and run separately from power cables.

Remote Emergency Power Off—GXT4-5000RT208, GXT4-6000RT208, GXT4-8000RT208, GXT4-10000RT208

+24 V supplied by GXT4 UPS

How UPS ships, with jumper removed and in the accessory bag.

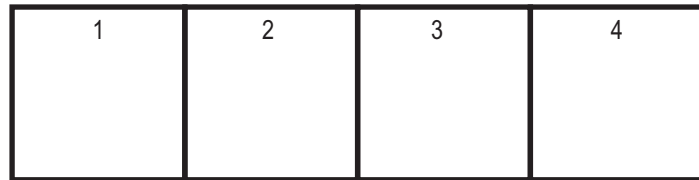

+24 V supplied by GXT4 UPS

How UPS must be wired to operate with no repo connection. Jumper in accessory bag must be installed.

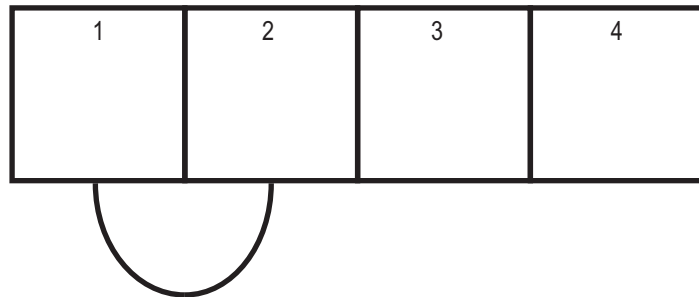

+24 V supplied by GXT4 UPS

How UPS must be wired to operate with connection to a normally-closed (NC) repo connection. Jumper in accessory bag must be removed as this wired to a remote switch.

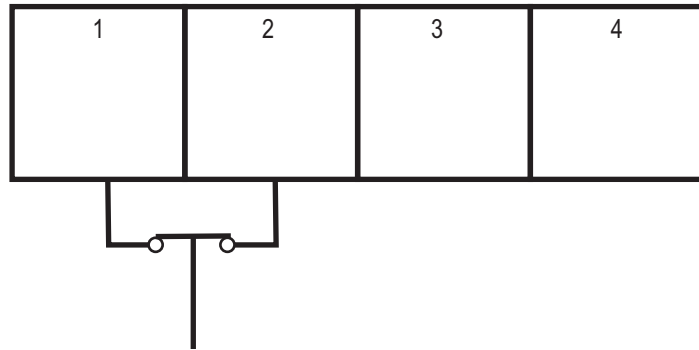

+24 V supplied by GXT4 UPS

How UPS must be wired to operate with connection to a normally-open (NO) repo connection. Jumper in accessory bag must be installed.

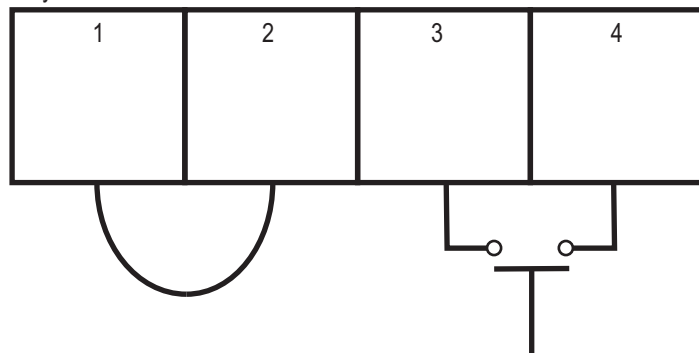

6.0 Maintenance

This section describes replacing the internal battery pack, precautions, checking the Liebert GXT4's status and checking UPS functions.



WARNING

The battery can present a risk of electrical shock and high short circuit current. The following precautions should be observed before replacing the battery pack:

- Remove rings, watches and other metal objects.
- Use tools with insulated handles.
- Do not lay tools or other metal objects on the batteries.
- If the battery kit is damaged in any way or shows signs of leakage, contact your local Emerson representative immediately.
- Do not dispose of batteries in a fire. The batteries may explode.
- Handle, transport and recycle batteries in accordance with local regulations.

6.1 Replacing the Internal Battery Pack

The Liebert GXT4 is designed to allow the user to replace the internal battery pack safely. Refer to **Table 6-1** for internal battery pack part numbers for Liebert GXT4 UPS:

Table 6-1 Replacement internal battery pack model number

UPS Model Number	Replacement Internal Battery Pack Model Number	Quantity Required
GXT4-5000RT208 GXT4-6000RT208	GXT4-144VBATKIT	1
GXT4-6000RTL630	GXT4-240VBATKIT	2
GXT4-8000RT208 GXT4-10000RT208	GXT4-240VRTBKIT	2

6.1.1 Battery Replacement Procedures

Read all safety cautions before proceeding. A trained user can replace the internal battery pack when the UPS is always in a restricted access location (such as a rack or server closet). Contact your local dealer or Emerson representative to obtain the pricing of the appropriate replacement battery pack.

! CAUTION

Risk of explosion if battery is replaced by an incorrect type. Dispose of used batteries according to the instructions.

1. Remove the front plastic bezel cover from the UPS.
2. Loosen and remove the 6 screws on the battery door, as shown in **Figure 6-1**.
3. Lay the battery door and screws aside for reassembly.

Figure 6-1 Removing the front bezel cover and battery door

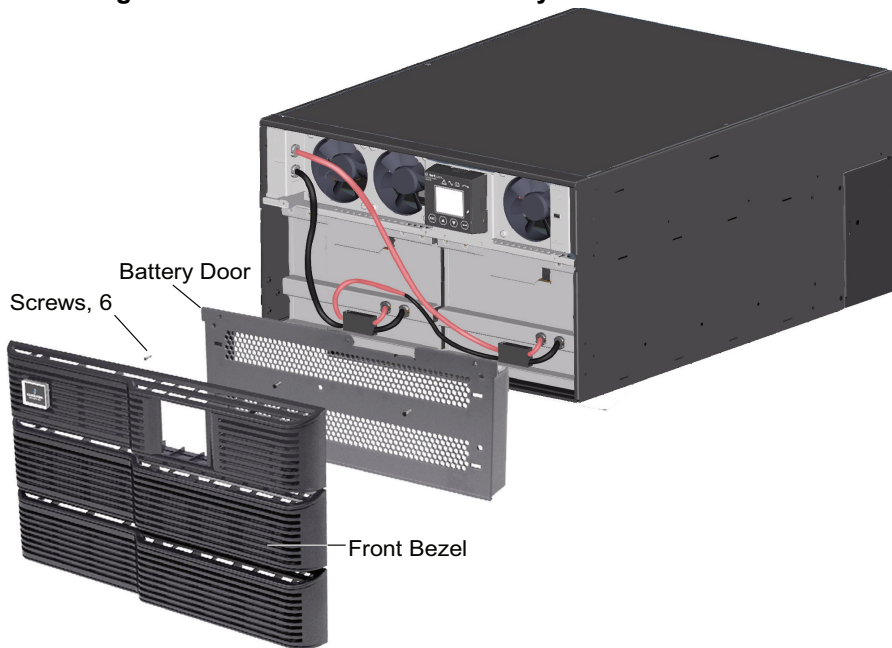

4. Gently pull the battery wire out and disconnect the battery plug and battery receptacle, as shown in **Figure 6-2**.

Figure 6-2 Disconnecting the battery plug and battery receptacle (front view)

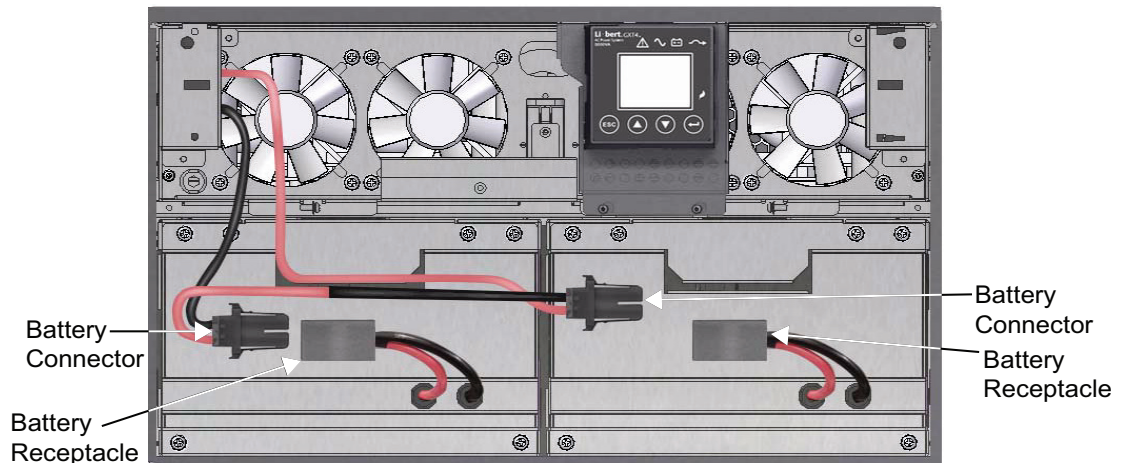

- Grasp the battery handle, and pull the internal battery pack out of the UPS, as shown in **Figure 6-3**. Repeat this step if both battery packs will be replaced. Each model has two battery packs.

Figure 6-3 Pull out the battery

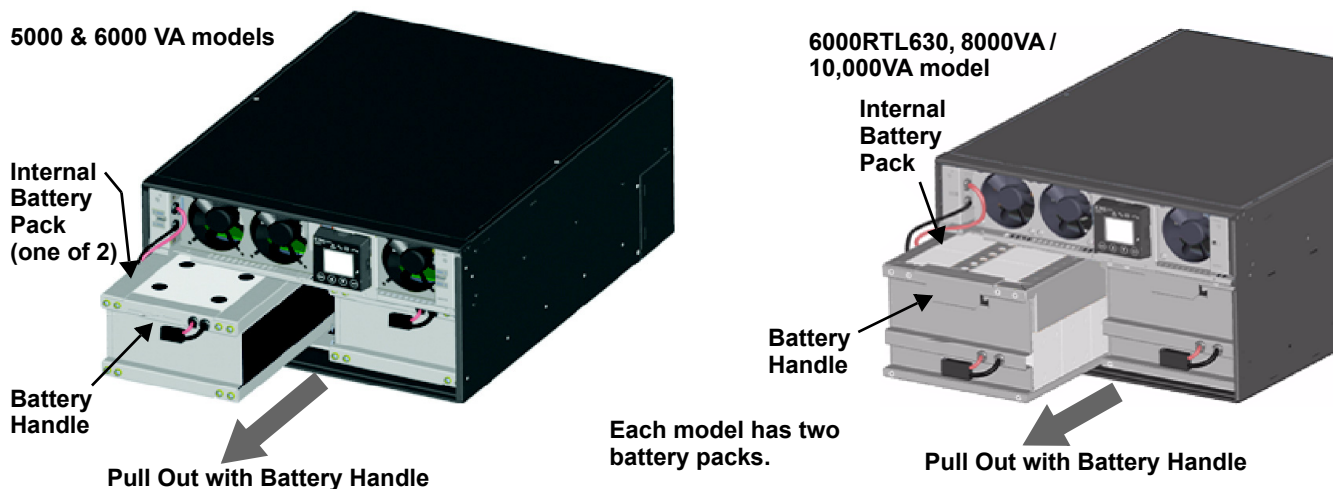

- Unpack the new internal battery pack. Take care not to destroy the packing. Compare the new and old internal battery pack to make sure they are the same type and model. If so, proceed with **Step 7**; if they are different, stop and contact your local Emerson representative, or Emerson Channel Support.
- Line up and slide in the new internal battery pack.
- Reconnect the battery plug and battery receptacle
- Push the battery wire and internal battery pack back into the UPS.
- Reattach the front battery door with the six screws.
- Reattach the front plastic bezel cover to the UPS.



NOTE

The internal battery pack is hot-swappable. However, caution should be exercised because during this procedure the load is unprotected from disturbances and power outages. Do not replace the battery while the UPS is operating in Battery Mode. This will result in a loss of output power and will drop the connected load.

6.2 Battery Charging

The batteries are valve-regulated, nonspillable, lead acid and should be kept charged to attain their design life. The Liebert GXT4 charges the batteries continuously when it is connected to the utility input power.

If the Liebert GXT4 will be stored for a long time, Emerson recommends connecting the UPS to input power for at least 24 hours every four to six months to ensure full recharge of the batteries.

6.3 Precautions

Although the Liebert GXT4 has been designed and manufactured to ensure personal safety, improper use can result in electrical shock or fire. To ensure safety, observe the following precautions:

- Turn Off and unplug the Liebert GXT4 before cleaning it.
- Wear rubber gloves and boots.
- Clean the UPS with a dry cloth. Do not use liquid or aerosol cleaners.
- Never block or insert any objects into the ventilation holes or other openings of the Liebert GXT4.
- Do not place the Liebert GXT4 power cord where it might be damaged.

6.4 Checking UPS Status

Emerson recommends checking the UPS operation status every six months.

- Check if the UPS is faulty: Is the Fault Indicator On? Is the UPS sounding an alarm?
- Check if the UPS is operating in Bypass mode: Normally, the UPS operates in Normal Mode; if it is operating in Bypass Mode, stop and contact your local Emerson representative or Emerson Channel Support.
- Check if the battery is discharging: When the utility input is normal, the battery should not discharge. If the UPS is operating in Battery Mode, stop and contact your local Emerson representative or Emerson Channel Support.

6.5 Checking UPS Functions



NOTE

UPS function check procedures may interrupt power supply to the connected load.

Emerson recommends checking the UPS functions once every six months.

Back up the load data before conducting the UPS functions check. Procedures are as follows:

1. Press the Standby/Manual Bypass button to check whether the alarm and indicators are normal.
2. Press the On/Alarm Silence/Manual Battery Test button to check again whether the indicators are On and the UPS is operating normally.
3. Press the On/Alarm Silence/Manual Battery Test button for three seconds after Inverter Mode. The UPS should initiate battery self-test. Check to determine whether the battery is operating normally. If not, stop and contact your local Emerson representative or Emerson Channel Support.

6.6 Replacing the Power Module on 8000 and 10,000VA models



CAUTION

The UPS must be switched to manual bypass before personnel begin to replace the power module.

NOTICE

During the procedure, the connected load will not be protected from power disturbances, such as spikes, sags and failure.

To remove the UPS power module without shutting off power to the connected load:

1. Place the UPS on internal bypass. This may be done by any of the three following methods:
 - a. Refer to **4.4 - Manual Bypass**.
 - b. Slide the bracket away from the manual bypass switch on the rear of the UPS; this requires loosening the captive screw and sliding the bracket away from the manual bypass switch.
 - c. Remove the front grille covering the power module.
2. Move the manual bypass breaker on the rear of the UPS to the bypass position; this requires loosening the captive screw and sliding the bracket away from the manual bypass switch (see **Figure 1-6**).
3. Open the input circuit breaker on the rear of the UPS (see **Figure 1-6**).
4. Open the output circuit breaker on the rear of the UPS (see **Figure 1-6**).
5. Remove the top two front plastic bezels by pulling them forward.
6. Remove the power module cover grille and the battery cover grille with the screws securing them to the frame.
7. Disconnect the slotted battery connectors from the internal battery packs.
8. If additional external batteries are used, disconnect the two external battery connectors.
9. Slide power module restraint lever up out of the locked position.
10. Slide the power module out the front, supporting its weight as it is withdrawn.

Figure 6-4 Removing power module from Liebert GXT4 8000 and 10,000VA models

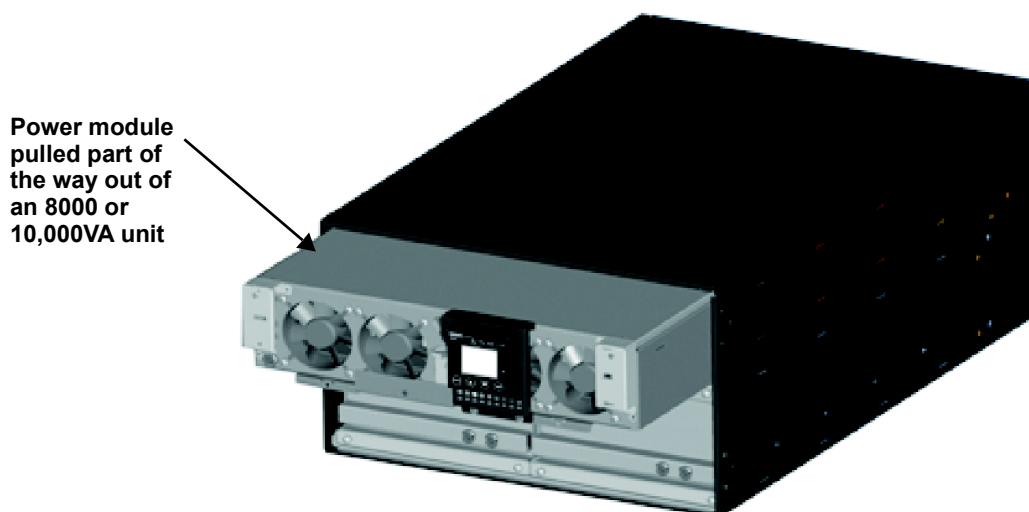

11. Insert the replacement UPS power module.
12. Slide the power module restraint lever back into the locked position.
13. Reconnect the slotted internal battery connectors.

14. Reconnect the external battery cables, if used.
15. Reattach both front cover grilles.
16. Reattach the front plastic bezels.
17. Close the input circuit breaker on the rear of the UPS (see **Figure 1-6**).
18. Close the output circuit breaker on the rear of the UPS (see **Figure 1-6**).
19. Move the bypass breaker on the rear of the UPS back to the INVERTER position (see **Figure 1-6**).
20. Slide the bracket back next to the manual bypass breaker and tighten its thumbscrew.
21. Press the On button on the front panel one time to return the UPS to Normal Mode operation (see **Figure 3-1**).



NOTE

The power module restraint lever must be fully engaged for the UPS to operate in Normal Mode.

7.0 Troubleshooting

This section indicates various UPS symptoms a user may encounter and provides a troubleshooting guide in the event the UPS develops a problem. Use the following information to determine whether external factors caused the problem and how to remedy the situation.

7.1 UPS Symptoms

The following symptoms indicate the Liebert GXT4 is malfunctioning:

- The relative indicators illuminate, indicating the UPS has detected a problem.
- An alarm buzzer sounds, alerting the user that the UPS requires attention.

7.1.1 Indicator and LCD

In addition to the fault indicator being illuminated, the LCD will display the fault. The displayed fault on the LCD is described in **Table 7-1**

Table 7-1 Description of the displayed fault

Displayed Fault	Cause	Corrective Steps
UPS self test failed	The battery is bad or weak.	Contact customer service.
UPS shutdown command received	The UPS shuts down through communication.	Contact customer service.
UPS overload	The UPS is overloaded.	Reduce the load and contact customer service.
Inverter Out of Order	The inverter is faulty.	Contact customer service.
Battery Weak/Bad	The battery is bad or weak.	Replace the battery.
Output Short Circuit	The output connection is short-circuited.	Shut down the equipment and contact customer service.
DC Bus Overvoltage	The DC bus is faulty.	Contact customer service.
UPS Overtemperature	Over-temperature occurs to the UPS and the UPS will transfer to Bypass mode.	Reduce the load and contact customer service.
Charger Out of Order	The charger is faulty.	Contact customer service.
Fan Out of Order	At least one fan is faulty.	Contact customer service.
DC Bus Discharge Fail	A DC-DC failure occurs.	Contact customer service.



NOTE

If the UPS encounters a fault and no correction attempt is performed within 2 minutes, the LCD backlight will flash (on 1 second and off 1 second) as an alert.

Press any button to exit the alert mode. If no correction attempt is performed on the UPS, the LCD backlight will flash again until the UPS fault is corrected.

7.1.2 Audible Alarm

An audible alarm will sound in conjunction with the visual indicators to indicate a change in UPS operating status. The audible alarm will sound as described in **Table 7-2**.

Table 7-2 Audible alarm description

Condition	Alarm
Battery discharge	Half-second beep every 10 seconds
Low battery	Two half-second beeps every 5 seconds
UPS fault, load on bypass	1-second beep every 4 seconds
UPS fault, no power to load	Continuous
Overload	Half-second beep every half second
Battery replacement	2-second beep every 2 minutes
Battery loss	Continuous
Wiring problem (loss of proper grounding for UPS)	Continuous
Bypass reminder	1-second beep every 60 seconds

7.2 Troubleshooting

In the event of an issue with the UPS, refer to **Table 7-3** to determine the cause and solution. If the fault persists, contact Emerson® Channel Support.

Table 7-3 Troubleshooting table

Problem	Cause	Solution
UPS fails to start	UPS is short-circuited or overloaded	Ensure UPS is Off. Disconnect all loads and ensure nothing is lodged in output receptacles. Ensure loads are not defective or shorted internally.
	Batteries are not charged enough or not connected	Check to ensure the internal battery is connected. If it is not, make the connection and try to start the unit. If the battery is connected, leave the UPS connected to input power for 24 hours to recharge batteries, then try to start the unit.
Battery indicator is illuminated	UPS is not plugged in	UPS is operating from battery mode. Ensure UPS is securely plugged into the wall receptacle.
	UPS input protection fuse has blown/opened	UPS is operating from battery mode. Save data and close applications. Replace UPS input fuse, then restart UPS.
	Mains power is out of tolerance	UPS is operating from battery mode. Save data and close applications. Ensure mains supply voltage is within acceptable limits for UPS.
UPS has reduced battery backup time	Batteries are not fully charged	Keep UPS plugged in continuously at least 24 hours to recharge batteries.
	UPS is overloaded	Check load level indicator and reduce the load on the UPS.
	Batteries may not be able to hold a full charge due to age	Replace batteries. Contact your local dealer, Emerson representative or Emerson Channel Support for replacement battery kit.
Battery indicator is flashing.	Battery source is not available; continuous horn.	Check battery connections, completely power down and restart UPS. NOTE: If the battery circuit opens while the UPS is running, it will be detected when the next battery test is performed.
Bypass indicator is flashing.	Because the voltage or frequency is outside acceptable limits, the bypass is disabled.	The AC input powers the PFC input and serves as the bypass source. If the AC is present but the voltage or frequency exceeds the acceptable range for safe operation with a load, the bypass will be disabled and this indicator will flash, indicating that the bypass is unavailable.

When reporting a UPS issue to Emerson, include the UPS model and serial number. These are located in several places for your ease of location:

- on the top panel (rack mount orientation)
- the left side (tower orientation)
- the rear panel
- on the front of the unit behind the front plastic bezel
- on the LCD select *Main Menu > About*.

Page intentionally left blank.

8.0 Specifications

Table 8-1 UPS specifications—5000, 6000, 8000 and 10,000 models

Model Number	GXT4-5000RT208	GXT4-6000RT208	GXT4-8000RT208	GXT4-10000RT208
Model Rating	4000W/5000VA	4800W/6000VA	7200W/8000VA	9000W/10000VA
Dimensions, Rack Mount, W x D x H				
Unit, in. (mm)	16.9 x 26.1 x 6.8 (430 x 662 x 173)		16.9 x 26.5 x 10.3 (430 x 672 x 261)	
Shipping, in. (mm)	35 x 27 x 26 (889 x 686 x 661)		35 x 27 x 32 (889 x 686 x 813)	
Weight lb (kg)				
Unit, lb (kg)	131.8 (59.8)		212.7 (96.7)	
Shipping, lb (kg)	202.8 (92)		297.6 (135)	
Input AC Parameters				
Nominal Operating Frequency	50 or 60Hz (Factory Default is 60Hz)			
Factory Default VAC	120/208VAC at 120 degrees		120/208VAC at 120 degrees	
L1-L2 Factory Default Input Phase Angle	120 degrees		120 degrees	
Allowable Input Phase Angle	120, 180, 240 degrees, auto-sensing on application of alternating current (Restrictions for L-N voltages other than 120VAC)			
Factory Default L1-N, L2-N VAC	120 VAC nominal			
User Configurable L1-N, L2-N VAC	100/110/115/120VAC (can be modified with configuration program)			
Input Frequency w/o Battery Operation	40 - 70 Hz			
Input Power Connection	Hard-Wired Terminal Block 3W + G (L-L-N-G)			
L1-N, L2-N Maximum Allowable VAC	150VAC			
Output AC Parameters				
Factory Default VAC	120/208VAC @ 120 degrees			
L1-L2 Factory Default Output Phase Angle	120 degrees			
Allowable Output Phase Angle	120, 180, 240 degrees, auto-sensing on initial application of input AC			
Factory Default L1-N, L2-N VAC	120VAC nominal			
User Configurable L1-N, L2-N VAC	100/110/115/120/127VAC, $\pm 2\%$			
L1-N, L2-N, Operating Load Range				
105% to 130%	1 Minute			
131% to 150%	10 seconds			
151% to 200%	1 second			
>200% (impact load)	At least 5 cycles			
Bypass Protection Limits				
Disable Bypass Operation	If input voltage exceeds $\pm 15\%$ of the nominal voltage			
Re-Enable Bypass Operation	If input voltage returns to within $\pm 10\%$ of nominal output voltage			
Disable Bypass Operation	When the input frequency prevents synchronous operation			
Environmental				
Operating Temp, °F (°C)	32 to 104 (0 to 40)			
Storage Temp, °F (°C)	5 to 122 (-15 to 50)			
Relative Humidity	0% to 95%, non-condensing			
Operating Elevation	Up to 10,000 ft. (3000m) at 77°F (25°C) without derating			
Audible Noise	less than 55dBA at 3.2ft. (1m) rear; less than 50dBA at 3.2ft. (1m) front and sides			
Agency				
Safety	UL 1778, c-UL Listed			
RFI/EMI	FCC Class A			
Surge Immunity	IEEE/ANSI C62.41 Category A & B			
Transportation	ISTA Procedure 1E			

Table 8-2 UPS specifications—Liebert GXT4-6000RTL630

Model Number	GXT4-6000RTL630
Model Rating	4200W/6000VA
Dimensions, Rack Mount, W X D X H, in. (mm)	
Unit	16.9 x 22.6 x 8.5 (430 x 574 x 217)
Shipping	35 x 27 x 29 (889 x 686 x 737)
Weight, lb (kg)	
Unit	132.2 (60)
Shipping	216.5 (98)
Input AC Parameters	
Nominal Operating Frequency	50 or 60Hz (Factory Default, 60)
Factory Default VAC	208VAC
User Configurable VAC	208/220/230/240VAC (may be modified with configuration program)
Operating Voltage Range Without Battery Operation	176 – 280VAC
Maximum Allowable VAC	280VAC
Input Frequency Without Battery Operation	40 - 70Hz
Input Power Connection	L6-30P Plug (on PD-L630 power distribution box)
Output AC Parameters	
Factory Default VAC	208
Output Connections	(2) L6-20R and (2) L6-30R on 12" (300mm) cords (on PD-L630 power distribution box)
Frequency	50Hz or 60Hz, Nominal
Waveform	Sinewave
Duration Inverter Will Support Rated Load	
105% to 130%	1 Minute
131% to 150%	10 seconds
151% to 200%	1 second
>200% (impact load)	At least 5 cycles
Bypass Protection Limits	
Disable Bypass Operation	If input voltage exceeds $\pm 15\%$ of the nominal voltage
Re-Enable Bypass Operation	If input voltage returns to within $\pm 10\%$ of nominal output voltage
Disable Bypass Operation	When the input frequency prevents synchronous operation
Environmental	
Operating Temp, °F (°C)	32 to 104 (0 to 40); No Derating
Storage Temp, °F (°C)	5 to 122 (-15 to 50)
Humidity	0% to 95% Relative Humidity, non-condensing
Operating Elevation	Up to 10,000 ft. (3000m) at 77°F (25°C) without derating
Audible Noise	Less than 55dBA at 3.2ft. (1m) rear; Less than 50dBA at 3.2ft. (1m) front and sides
Agency	
Safety	UL 1778, c-UL Listed
EMI/EMC	FCC Class A
ESD	EN61000-4-2
Radiated Susceptibility	EN61000-4-3
Electrical Fast Transient	EN61000-4-4
Surge Immunity	EN61000-4-5
Transportation	ISTA Procedure 1E

Table 8-3 Internal battery cabinet specifications

Model Number	GXT4-144VBATKIT	GXT4-240VBATKIT	GXT4-288VBATKIT
Used with UPS Model	GXT4-5000RT208 GXT4-6000RT208	GXT4-6000RTL630	GXT4-8000RT208 GXT4-10000RT208
Dimensions, Rack Mount, W x D x H, in (mm)			
Unit	8.1 x 19.3 x 2.8 (206 x 490 x 70)	7.2 x 15.4 x 4.4 (184 x 390 x 113)	8.1 x 19.7 x 5.3 (207 x 500 x 135)
Shipping	10.3 x 23.7 x 12.2 (262 x 602 x 310)	10.3 x 18.4 x 7 (262 x 467 x 178)	9.5 x 23.9 x 12.2 (242 x 607 x 310)
Weight lb (kg)			
Unit	75.8 (34.4)	45.4 (20.6)	71.1 (32.3)
Shipping	81.1 (36.8)	50.7 (23)	76.4 (34.7)
Type	Valve-regulated, non-spillable, flame retardant, lead acid		
Quantity x V x Rating	2 x 6 x 12V x 9.0 AH	2 x 10 x 12V x 5.0AH	2 x 12 x 12V x 9.0 AH
Battery Mfr / Part #	CSB UPS12460F2	CSB/HR1221W	CSB UPS12460F2
Backup Time	See Table 8-8		
Recharge Time	5 hours to 90% capacity after full discharge into 100% load		
Environmental			
Operating Temp, °F (°C)	32 to 104 (0 to 40)		
Storage Temp, °F (°C)	5 to 122 (-15 to 50)		
Relative Humidity	0% to 95%, non-condensing		
Operating Elevation	Up to 10,000 ft. (3000m) at 77°F (25°C) without derating		
Agency			
Safety	UL 1778, c-UL Listed		
RFI/EMI	FCC Class A		
Transportation	ISTA Procedure 1A		

Table 8-4 External battery cabinet specifications

Model Number	GXT4-144VBATT	GXT4-240VBATT	GXT4-288VBATT
Used w/UPS Model	GXT4-5000 & GXT4-6000RT208	GXT4-6000RTL630	GXT4-8000 & GXT4-10000RT208
Dimensions, W x D x H, in. (mm)			
Unit (with bezel)	16.9 x 26.1 x 3.3 (430 x 662 x 85)	16.9 x 22.6 x 6.8 (430 x 574 x 173)	16.9 x 26.5 x 6.8 (430 x 672 x 173)
Shipping	25.8 x 34.3 x 12.3 (655 x 872 x 312)	20.9 x 29.3 x 18.7 (530 x 745 x 475)	24.5 x 33.1 x 18.7 (622 x 842 x 475)
Weight, lb (kg)			
Unit	99.9 (45.3)	143.3 (65)	167.6 (76.2)
Shipping	121 (55)	176.4 (80)	198 (90)
Battery Parameters			
Type	Valve-regulated, non-spillable, lead acid		
Qty x V	2 x 6 x 12V x 9.0 AH	2 x 10 x 12V x 9.0AH	2 x 12 x 12V x 9.0 AH
Battery Mfr., Part #	CSB UPS12460F2; CSBHR1234WF2		
Backup Time	See Table 8-8		
Environmental			
Operating Temp, °F (°C)	32 to 104 (0 to 40)		
Storage Temp, °F (°C)	5 to 122 (-15 to 50)		
Relative Humidity	0% to 95%, non-condensing		
Operating Elevation	Up to 10,000 ft. (3000m) at 77°F (25°C) without derating		
Agency			
Safety	UL 1778, c-UL Listed		
RFI/EMI	FCC Class A		
Transportation	ISTA Procedure 1A		

Table 8-5 Power distribution specifications: GXT4-5000RT208, GXT4-6000RT208 and GXT4-6000RTL630 *

PD Model #	Power Distribution Box Model #								
	PD2-HDWR-MBS	PD2-001	PD2-002	PD2-003	PD2-004	PD2-005	PD2-006	PD2-007	PD2-L630 *
Dimensions, W x D x H, in (mm)									
Unit	5.2x15.5x3.5 (132x393x88)								4.7x13.2x4.1 (119x335x105)
Shipping	9.5x20.7x9.1 (242x527x230)								10.2x18.4x8.7 (260x467 x222)
Weight, lb (kg)									
Unit	6 (2.7)	8.8 (4)	8.6 (3.9)	8.6 (3.9)	9.9 (4.5)	10.6 (4.8)	9.5 (4.3)	9.5 (4.3)	8.8 (4)
Shipping	8.2 (3.7)	11 (5)	10.8 (4.9)	10.8 (4.9)	12.1 (5.5)	12.8 (5.8)	11.7 (5.3)	11.7 (5.3)	11 (5)
Electrical Specifications									
Amp Rating	30A 2-pole input breaker for UPS input power								
Input Power Connections	Hard-Wired Terminal Block 3W + G (L-L-N-G)	(1) L14-30P on a 10.5 ft. (3.2m) cord							(1) L6-30P
Output Power Connection	Hard-Wired Terminal Block 3W + G (L-L-N-G)	(4) 5-20R (1) L14-30R (1) L6-30R	(2) 5-20R (2) L6-20R	(4) 5-20R (2) L6-30R	(4) L5-20R (2) L5-30R	(4) L5-20R (2) L6-30R	(4) L6-20R	(2) L5-20R (2) L6-20R	(2) L6-30R (2) L6-20R

* PD2-L630 is only compatible with the GXT4-6000RTL630 UPS model

Table 8-6 Power distribution box specifications for GXT4-8000RT208 and GXT4-10000RT208

POD Model #	Power Distribution Box Model #					
	PD2-101	PD2-102	PD2-103	PD2-104	PD2-105	PD2-106
Dimensions, W x D x H, in. (mm)						
Unit	7.4 x 5.7 (188 x 145)					
Shipping	11.9 x 20.6 x 8.7 (302 x 522 x 220)					
Weight, lb (kg)						
Unit	4.4 (2)	6.6 (3)	6.6 (3)	6.6 (3)	4.4 (2)	6.6 (3)
Shipping	6.6 (3)	8.8 (4)	8.8 (4)	8.8 (4)	6.6 (3)	8.8 (4)
Electrical Specifications						
Amp Rating	2-pole 60A Input Breaker					
Input Power Connection	Custom Connector 3W + G(L-L-N-G) to UPS					
Output Power Connections	(2) L6-30R (8) 5-15/20R	(4) L6-20R (4) 5-15/20R	(4) 5-15/20R (4) L6-30R	(4) 5-15/20R (2) L6-30R (2) L6-20R	(4) 5-15/20R (2) L5-30R (2) L5-20R	(4) L6-20R (4) L5-20R

Table 8-7 Power distribution box specifications for GXT4-8000RT208 and GXT4-10000RT208

POD Model #	Power Distribution Box Model #						
	PD2-107	PD2-108	PD2-109	PD2-200	PD2-201	PD2-202	PD2-204
Dimensions, W x D x H, in. (mm)							
Unit	7.4 x 5.7 (188 x 145)						
Shipping	11.9 x 20.6 x 8.7 (302 x 522 x 220)						
Weight, lb (kg)							
Unit	6.6 (3)			4.4 (2)			6.6 (3)
Shipping	8.8 (4)			6.6 (3)			15 (6.8)
Electrical Specifications							
Amp Rating	2-pole 60A Input Breaker						
Input Power Connection	Custom Connector 3W + G(L-L-N-G) to UPS						
Output Power Connections	(4) L5-20R (4) 5-15/20R	(2) L6-20R (2) L6-30R	(2) L14-30R	(4) IEC320-C19 (4) IEC320-C13	(2) IEC320-C19 (8) IEC320-C13	(12) IEC320-C13	(2) IEC309-32A (4) IEC320-C13

Table 8-8 Battery run time, minutes

Number of External Battery Cabinets	Load Percent of Capacity	208/120 VAC RT Models				208 VAC RT Model
		5 kVA	6 kVA	8 kVA	10 kVA	6 kVA (L630)
Internal Battery	10%	134	112	121	98	92
	20%	65	52	63	48	39
	30%	39	31	42	32	34
	40%	27	21	29	22	26
	50%	20	15	22	16	18
	60%	16	12	18	13	16
	70%	12	9	14	10	12
	80%	10	8	11	7	10
	90%	8	6	9	7	9
	100%	7	5	8	5	8
Internal Battery + 1 External Battery Cabinet	10%	281	235	256	206	265
	20%	144	119	142	113	124
	30%	92	77	100	79	99
	40%	67	53	72	55	67
	50%	50	40	55	42	52
	60%	40	32	44	34	44
	70%	33	26	36	27	34
	80%	27	21	29	21	27
	90%	23	18	25	20	24
	100%	20	15	22	16	21
Internal Battery + 2 External Battery Cabinets	10%	441	367	400	322	462
	20%	222	186	217	175	223
	30%	146	120	156	124	177
	40%	108	88	114	90	126
	50%	84	68	90	72	98
	60%	68	53	77	57	85
	70%	55	43	59	45	66
	80%	46	38	49	37	52
	90%	40	32	43	35	48
	100%	36	27	39	29	43
Internal Battery + 3 External Battery Cabinets	10%	603	505	550	444	671
	20%	304	252	298	236	323
	30%	198	166	210	170	254
	40%	147	122	156	126	182
	50%	117	95	126	100	145
	60%	95	78	106	82	126
	70%	81	63	86	68	100
	80%	68	53	72	53	83
	90%	57	45	61	50	74
	100%	50	40	55	42	65

Run times in this table are approximate. They are based on new, fully charged standard battery modules at a temperature of 77°F (25°C) with 100% resistive UPS loading. Run times listed above can vary by ±5% due to manufacturing variances of the individual batteries.

Table 8-8 Battery run time, minutes (continued)

Number of External Battery Cabinets	Load Percent of Capacity	208/120 VAC RT Models				208 VAC RT Model
		5 kVA	6 kVA	8 kVA	10 kVA	6 kVA (L630)
Internal Battery + 4 External Battery Cabinets	10%	766	638	696	566	883
	20%	389	322	381	302	429
	30%	252	208	269	214	336
	40%	188	156	198	161	237
	50%	149	122	161	129	190
	60%	122	100	136	107	166
	70%	104	84	111	87	135
	80%	88	72	92	72	111
	90%	78	60	83	67	100
	100%	68	53	75	56	90
Internal Battery + 5 External Battery Cabinets	10%	939	783	854	685	1108
	20%	476	393	467	370	538
	30%	307	255	329	262	420
	40%	227	190	239	195	296
	50%	181	149	195	156	235
	60%	149	122	166	130	207
	70%	127	104	136	109	168
	80%	110	88	114	88	139
	90%	95	78	102	84	126
	100%	84	67	91	73	115
Internal Battery + 6 External Battery Cabinets	10%	1116	931	1015	814	1329
	20%	564	468	553	440	643
	30%	364	301	389	310	506
	40%	268	223	285	229	356
	50%	212	177	228	184	283
	60%	177	145	194	153	247
	70%	149	122	160	129	201
	80%	130	106	136	106	167
	90%	114	91	119	100	152
	100%	101	82	110	86	139

Run times in this table are approximate. They are based on new, fully charged standard battery modules at a temperature of 77°F (25°C) with 100% resistive UPS loading. Run times listed above can vary by ±5% due to manufacturing variances of the individual batteries.

Using the configuration program or the LCD panel, the user may specify the number of external battery cabinets attached to the UPS. The factory default is programmed for internal batteries only.

Table 8-8 shows the estimated run times at different loads.

8.1 Auto-Learning Battery Run Times

As batteries age, the estimated run times may become less accurate. The Liebert GXT4 is programmed to “learn” from a full battery discharge and modify the estimated run time for the measured battery capacity. This can improve accuracy and compensate for aging batteries or batteries that operate at different ambient temperatures.

The UPS will update the anticipated run time calculation only under certain conditions.

- The UPS must have a steady load that is greater than 20%.
- The UPS must be at 100% charge at the start of a battery discharge.
- The battery discharge must continue uninterrupted until the batteries reach their end-of-discharge voltage.

If all conditions are not met, the run time calculation will not be modified.

If the configuration program is used to change the number of battery cabinets, then the values in **Table 8-8** will be restored. This will override any value that is Auto-Learned.

8.2 Product Warranty Registration

Registration is not required to activate the product warranty on a Liebert UPS. Registration is required to qualify for the Product Protection Promise. To register, visit the Emerson Network Power® Web site to fill out the online form at:

www.emersonnetworkpower.com/en-US/Forms/Pages/LiebertProductWarrantyRegistration.aspx

- To contact warranty support by e-mail: microups.warranty@emerson.com

8.3 Technical Support

Technical support contacts are listed on the back cover of this document. To contact Emerson Channel Product Support:

Phone

- NORTH AMERICA: 1-800-222-5877
- OUTSIDE NORTH AMERICA: 00-800-1155-4499

E-mail

- TECHNICAL SUPPORT: liebert.upstech@emerson.com

Technical Support / Service

Web Site

www.liebert.com

Monitoring

liebert.monitoring@emerson.com

800-222-5877

Outside North America: +00800 1155 4499

Single-Phase UPS & Server Cabinets

liebert.upstech@emerson.com

800-222-5877

Outside North America: +00800 1155 4499

Three-Phase UPS & Power Systems

800-543-2378

Outside North America: 614-841-6598

Thermal Management Systems

800-543-2778

Outside the United States: 614-888-0246

Locations

United States

1050 Dearborn Drive

P.O. Box 29186

Columbus, OH 43229

Europe

Via Leonardo Da Vinci 8

Zona Industriale Tognana

35028 Piove Di Sacco (PD) Italy

+39 049 9719 111

Fax: +39 049 5841 257

Asia

7/F, Dah Sing Financial Centre

108 Gloucester Road, Wanchai

Hong Kong

852 2572220

Fax: 852 28029250

While every precaution has been taken to ensure the accuracy and completeness of this literature, Liebert Corporation assumes no responsibility and disclaims all liability for damages resulting from use of this information or for any errors or omissions.

© 2016 Liebert Corporation

All rights reserved throughout the world.

Specifications subject to change without notice.

® Liebert is a registered trademark of Liebert Corporation. All names referred to are trademarks or registered trademarks of their respective owners.

SL-23194_REV2_6-16

590-1365-501A

Emerson Network Power

www.emersonnetworkpower.com

Free Manuals Download Website

<http://myh66.com>

<http://usermanuals.us>

<http://www.somanuals.com>

<http://www.4manuals.cc>

<http://www.manual-lib.com>

<http://www.404manual.com>

<http://www.luxmanual.com>

<http://aubethermostatmanual.com>

Golf course search by state

<http://golfingnear.com>

Email search by domain

<http://emailbydomain.com>

Auto manuals search

<http://auto.somanuals.com>

TV manuals search

<http://tv.somanuals.com>