

Rosemount™ Model 700 Breather Drain

Optional Breather Drain



Notice

ROSEMOUNT (“SELLER”) SHALL NOT BE LIABLE FOR TECHNICAL OR EDITORIAL ERRORS IN THIS MANUAL OR OMISSIONS FROM THIS MANUAL. SELLER MAKES NO WARRANTIES, EXPRESSED OR IMPLIED, INCLUDING THE IMPLIED WARRANTIES OF MERCHANTABILITY AND FITNESS FOR A PARTICULAR PURPOSE, WITH RESPECT TO THIS MANUAL AND, IN NO EVENT, SHALL SELLER BE LIABLE FOR ANY SPECIAL OR CONSEQUENTIAL DAMAGES INCLUDING, BUT NOT LIMITED TO, LOSS OF PRODUCTION, LOSS OF PROFITS, ETC.

PRODUCT NAMES USED HEREIN ARE FOR MANUFACTURER OR SUPPLIER IDENTIFICATION ONLY AND MAY BE TRADEMARKS/ REGISTERED TRADEMARKS OF THESE COMPANIES.

THE CONTENTS OF THIS PUBLICATION ARE PRESENTED FOR INFORMATIONAL PURPOSES ONLY, AND WHILE EVERY EFFORT HAS BEEN MADE TO ENSURE THEIR ACCURACY, THEY ARE NOT TO BE CONSTRUED AS WARRANTIES OR GUARANTEES, EXPRESSED OR IMPLIED, REGARDING THE PRODUCTS OR SERVICES DESCRIBED HEREIN OR THEIR USE OR APPLICABILITY. WE RESERVE THE RIGHT TO MODIFY OR IMPROVE THE DESIGNS OR SPECIFICATIONS OF SUCH PRODUCTS AT ANY TIME.

SELLER DOES NOT ASSUME RESPONSIBILITY FOR THE SELECTION, USE, OR MAINTENANCE OF ANY PRODUCT. RESPONSIBILITY FOR PROPER SELECTION, USE, AND MAINTENANCE OF ANY SELLER PRODUCT REMAINS SOLELY WITH THE PURCHASER AND END-USER.

Warranty

1. **LIMITED WARRANTY:** Subject to the limitations contained in Section 2 herein and except as otherwise expressly provided herein, Rosemount (“Seller”) warrants that the firmware will execute the programming instructions provided by Seller and that the Goods manufactured or Services provided by Seller will be free from defects in materials or workmanship under normal use and care until the expiration of the applicable warranty period. Goods are warranted for twelve (12) months from the date of initial installation or eighteen (18) months from the date of shipment by Seller, whichever period expires first. Consumables and Services are warranted for a period of 90 days from the date of shipment or completion of the Services. Products purchased by Seller from a third party for resale to Buyer (“Resale Products”) shall carry only the warranty extended by the original manufacturer. Buyer agrees that Seller has no liability for Resale Products beyond making a reasonable commercial effort to arrange for procurement and shipping of the Resale Products. If Buyer discovers any warranty defects and notifies Seller thereof in writing during the applicable warranty period, Seller shall, at its option, promptly correct any errors that are found by Seller in the firmware or Services, or repair or replace F.O.B. point of manufacture that portion of the Goods or firmware found by Seller to be defective, or refund the purchase price of the defective portion of the Goods/Services. All replacements or repairs necessitated by inadequate maintenance, normal wear and usage, unsuitable power sources, unsuitable environmental conditions, accident, misuse, improper installation, modification, repair, storage or handling, or any other cause not the fault of Seller are not covered by this limited warranty, and shall be at Buyer's expense. Seller shall not be obligated to pay any costs or charges incurred by Buyer or any other party except as may be agreed upon in writing in advance by an authorized Seller representative. All costs of dismantling, reinstallation and freight, and the time and expenses of Seller's personnel for site travel and diagnosis under this warranty clause shall be borne by Buyer unless accepted in writing by Seller. Goods repaired and parts replaced during the warranty period shall be in warranty for the remainder of the original warranty period or ninety (90) days, whichever is longer. This limited warranty is the only warranty made by Seller and can be amended only in a writing signed by an authorized representative of Seller. Except as otherwise expressly provided in the Agreement, THERE ARE NO REPRESENTATIONS OR WARRANTIES OF ANY KIND, EXPRESSED OR IMPLIED, AS TO MERCHANTABILITY, FITNESS FOR PARTICULAR PURPOSE, OR ANY OTHER MATTER WITH RESPECT TO ANY OF THE GOODS OR SERVICES. It is understood that corrosion or erosion of materials is not covered by our guarantee.
2. **LIMITATION OF REMEDY AND LIABILITY:** SELLER SHALL NOT BE LIABLE FOR DAMAGES CAUSED BY DELAY IN PERFORMANCE. THE SOLE AND EXCLUSIVE REMEDY FOR BREACH OF WARRANTY HEREUNDER SHALL BE LIMITED TO REPAIR, CORRECTION, REPLACEMENT, OR REFUND OF PURCHASE PRICE UNDER THE LIMITED WARRANTY CLAUSE IN SECTION 1 HEREIN. IN NO EVENT, REGARDLESS OF THE FORM OF THE CLAIM OR CAUSE OF ACTION (WHETHER BASED IN CONTRACT, INFRINGEMENT, NEGLIGENCE, STRICT LIABILITY, OTHER TORT, OR OTHERWISE), SHALL SELLER'S LIABILITY TO BUYER AND/OR ITS CUSTOMERS EXCEED THE PRICE TO BUYER OF THE SPECIFIC GOODS MANUFACTURED OR SERVICES PROVIDED BY SELLER GIVING RISE TO THE CLAIM OR CAUSE OF ACTION. BUYER AGREES THAT IN NO EVENT SHALL SELLER'S LIABILITY TO BUYER AND/OR ITS CUSTOMERS EXTEND TO INCLUDE INCIDENTAL, CONSEQUENTIAL, OR PUNITIVE DAMAGES. THE TERM “CONSEQUENTIAL DAMAGES” SHALL INCLUDE, BUT NOT BE LIMITED TO, LOSS OF ANTICIPATED PROFITS, LOSS OF USE, LOSS OF REVENUE, AND COST OF CAPITAL.

Safety and information notices

⚠ DANGER

WILL CAUSE DEATH

Failure to follow this warning will result in death or serious injury to personnel.

⚠ WARNING

DANGER TO PERSONNEL

Failure to follow this warning may result in serious injury to personnel.

⚠ CAUTION

MAY CAUSE DAMAGE TO EQUIPMENT

Failure to follow this warning may result in damage to the equipment.

NOTICE

Important messages will appear in this format.

Contents

Chapter 1	Certifications.....	7
	1.1 Certifications for the Rosemount Model 700 Breather Drain.....	7
Chapter 2	Specifications.....	9
	2.1 Rosemount Model 700 O-ring specifications.....	9
Chapter 3	Installation.....	11
	3.1 Install the breather drain.....	11
Chapter 4	Maintenance.....	15
	4.1 Maintaining the breather drain.....	15

1 Certifications

1.1 Certifications for the Rosemount Model 700 Breather Drain

These instructions provide guidance for the safe installation of the optional Ex D Breather Drain accessory for the Rosemount Model 700 Gas Chromatograph.

The breather drain plug is the following type:

Table 1-1: Breather/Drain

Specification	Description
Manufacturer: Emerson P/N:	Hoffman Enclosures Inc. 2-3-0700-739 (ATEX and IEC configurations only) ATEX Certificate: ITS13ATEX17900X <ul style="list-style-type: none"> • Ex d IIC Gb T6 • (Ta = -20 °C to 60 °C) IECEx Certificate: IECEx ITS 13.0049X <ul style="list-style-type: none"> • Ex d IIC Gb T6 • (Ta = -20 °C to 60 °C)
Manufacturer: Emerson P/N:	Killark 2-3-0700-740 (US and Canada configurations only) CSA/US: <ul style="list-style-type: none"> • Class I, Zone 1, AEx d IIC, Enclosure Type 4. Class I, Division 1, Groups B, C, and D, IP66 CSA/CANADA: <ul style="list-style-type: none"> • Class I, Zone 1, Ex d IIC, Enclosure Type 4. Class I, Division 1, Groups B, C, and D, IP66
NEMA	Type 4, 4X
IEC 60529	IP66

2 Specifications

2.1 Rosemount Model 700 O-ring specifications

Table 2-1: O-ring Materials and Temperature Limits

O-ring Material ⁽¹⁾	Limiting Temperature
Nitrile	-20 °C to 80 °C
EPDM	-30 °C to 125 °C
Neoprene	-20 °C to 100 °C
Silicone	-30 °C to 150 °C
Fluorosilicone	-50 °C to 150 °C

(1) It is the responsibility of the Emerson GC Service Team to ensure that the appropriate O-ring material is selected according to the type of application.

3 Installation

3.1 Install the breather drain

This installation procedures give general instructions for the safe installation of the optional Ex d breather drain.

Important

The breather drain accessory option is available for GCs without the optional LSIV only.

Figure 3-1: Rosemount Model 700 Breather Drain Installation Location

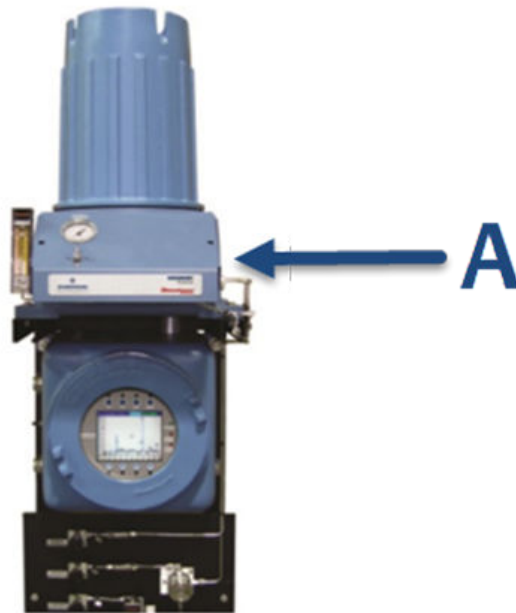

A. Breather drain installation location

Procedure

1. Install the breather drain in accordance with relevant local code and standards in the location as shown in [Figure 3-2](#).

Figure 3-2: Rosemount Model 700 Right Side View

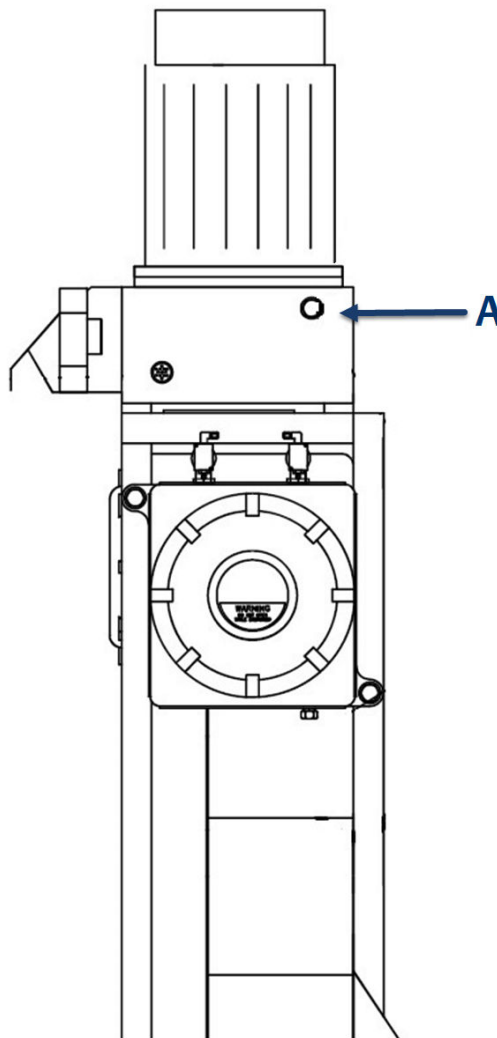

A. Breather drain plug installation location

2. De-energize the GC before commencing installation or maintenance procedures.
3. Installation of the breather drain is carried out by a recognized Emerson Service Technician, familiar with hazardous area classifications and trained in GC maintenance practices.
4. Remove dust, moisture, or debris from the area around the breather drain $\frac{3}{4}$ in. NPT opening (see [Figure 3-2](#)) to maintain the correct IP rating of the Rosemount Model 700 Gas Chromatograph.

5. Select the correct O-ring and fit it to the breather drain. Refer to [Rosemount Model 700 O-ring specifications](#).
6. Ensure the O-ring is properly seated in the groove in the breather plug.

Figure 3-3: Breather Drain O-rings for ATEX and IEC Applications

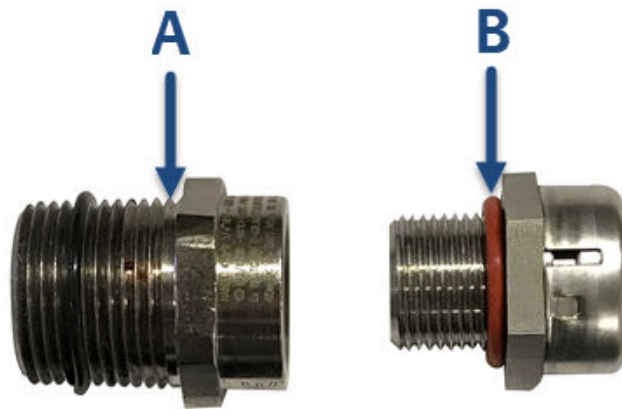

- A. Adapter with O-ring*
B. Breather drain with O-ring
-

7. Thread the breather drain into the $\frac{3}{4}$ in. NPT opening in the GC enclosure.

8. Hand-tighten using a $\frac{7}{8}$ in. combination wrench or spanner and ensure the drain is properly seated and securely tightened.

Figure 3-4: Breather Drain Assembly

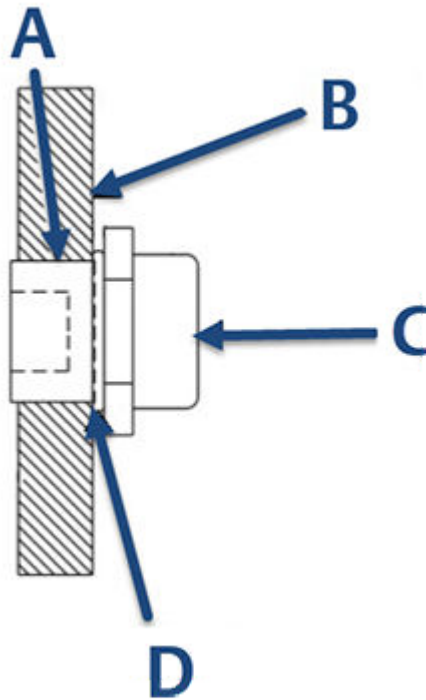

- A. Tapped hole
B. External wall of GC enclosure
C. Breather drain
D. O-ring seal

9. The recommended installation torque for the breather drain is as follows:

Thread Size	Recommended Installation Torque
$\frac{3}{4}$ in. NPT	Wrench tighten

4 Maintenance

4.1 Maintaining the breather drain

This section provides general maintenance for the Rosemount Model 700 breather drain.

Procedure

1. Check the breather drain during routine maintenance of the enclosure.
2. Remove surface debris that may accumulate on the internal O-ring dust seal using compressed air.
3. Clean the exterior drainage holes, if blocked, using compressed air.
4. During maintenance or routine inspection, replace the breather drain if it is damaged or broken.
5. Remove dust, moisture, or debris from the area around the breather drain $\frac{3}{4}$ in. NPT opening (see [Figure 3-2](#)) to maintain the correct IP rating of the Rosemount Model 700 Gas Chromatograph.
6. Follow the procedure, [Install the breather drain](#), to replace the breather drain.



AMERICAS

Emerson Automation Solutions
10241 West Little York, Suite 200
Houston, TX 77040 USA

-  Toll Free 866 422 3683
-  +1 713 396 8880 (North America)
-  +1 713 396 8759 (Latin America)
-  +1 713 466 8175
-  gc.csc@emerson.com



EUROPE

Emerson
Neuhofstrasse 19a PO Box 1046
CH-6340 Baar
Switzerland

-  +41 (0) 41 768 6111
-  +41 (0) 41 768 6300
-  gc.csc@emerson.com



MIDDLE EAST AND AFRICA

Emerson
Emerson FZE
Jebel Ali Free Zone
Dubai, United Arab Emirates, P.O. Box 17033

-  +971 4 811 8100
-  +971 4 886 5465
-  gc.csc@emerson.com

ASIA-PACIFIC

Emerson
1 Pandan Crescent
Singapore 128461
Republic of Singapore

-  +65 6 777 8211
-  +65 6 777 0947
-  gc.csc@emerson.com

 [Linkedin.com/company/Emerson-Automation-Solutions](https://www.linkedin.com/company/Emerson-Automation-Solutions)

 twitter.com/rosemount_news

 [Facebook.com/Rosemount](https://www.facebook.com/Rosemount)

 [youtube.com/RosemountMeasurement](https://www.youtube.com/RosemountMeasurement)

©2019 Emerson. All rights reserved.

The Emerson logo is a trademark and service mark of Emerson Electric Co. Rosemount is a mark of one of the Emerson family of companies. All other marks are the property of their respective owners.

Free Manuals Download Website

<http://myh66.com>

<http://usermanuals.us>

<http://www.somanuals.com>

<http://www.4manuals.cc>

<http://www.manual-lib.com>

<http://www.404manual.com>

<http://www.luxmanual.com>

<http://aubethermostatmanual.com>

Golf course search by state

<http://golfingnear.com>

Email search by domain

<http://emailbydomain.com>

Auto manuals search

<http://auto.somanuals.com>

TV manuals search

<http://tv.somanuals.com>