

Quick Setup

Before using the projector, make sure you read the safety instructions in the online *User's Guide*.

Choose a location

Keep the projector level and place it at a height so its lens is even with the top or bottom of the screen and is centered horizontally. If this isn't possible, use the lens shift feature or the keystone correction button on the projector to reposition the image (see "Adjust the image").

In order to view 3D images correctly, RF 3D glasses must be worn within 32 feet (10 m) of the projector. Use the image below to determine the viewing distance for 3D projection (the shading represents the 3D viewing area):

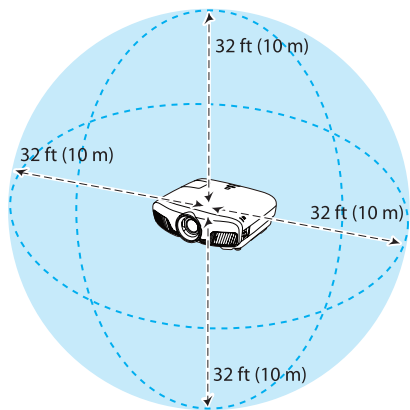

See the online *User's Guide* for more information on where to place your projector.

Connect the projector

Connect multiple video devices and use the Source buttons on the remote control or the  button on the projector to switch between them. For additional connection types, see the online *User's Guide*.

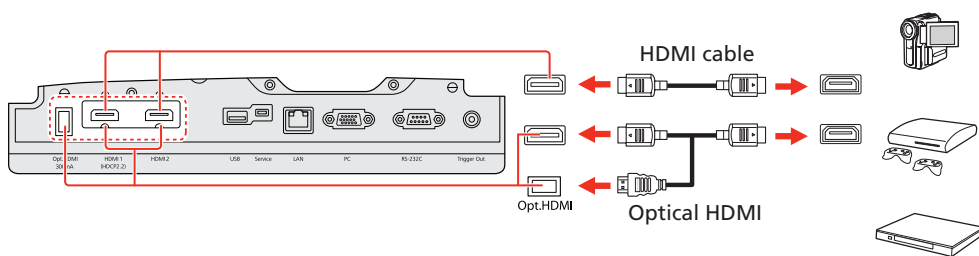



Note: When connecting a source that requires HDCP 2.2, you must use the HDMI1 port.

Turn on your equipment

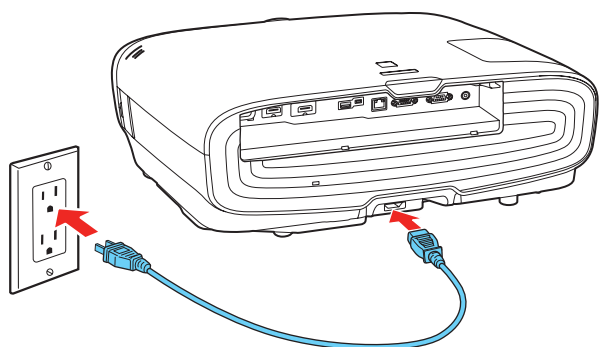
- 1 Turn on your video source.
- 2 Plug in the projector.



- 3 Press the  power button on the projector or the **On** button on the remote control. The shutter opens and the  power light flashes blue, then stays on.

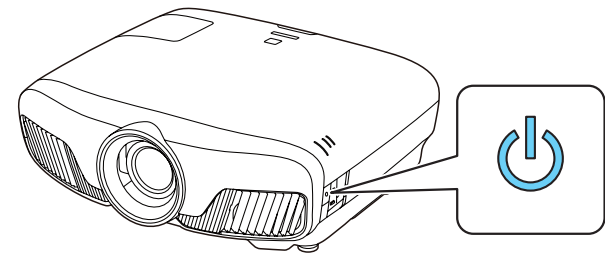

Note: To shut down the projector, press the  power button on the projector or the **Standby** button on the remote control, then press the button again to confirm, if necessary. Wait for cooldown to complete before unplugging the projector.

- 4 Use the arrow buttons on the remote control to highlight any of the options on the Home screen that appears, then press **Enter** to select it. You can display a QR code, switch between projection sources, and quickly access various adjustment options from this screen.

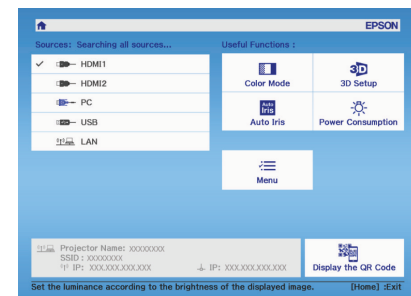

- 5 The default language of the menu system is English. To select another language, press the **Menu** button on the projector or remote control. Select **Extended** and press **Enter**. Select **Language** and press **Enter**. Select your language and press **Enter**. Press the **Menu** button to exit the menu system.

Using the remote control

Install the batteries as shown (two AA batteries).

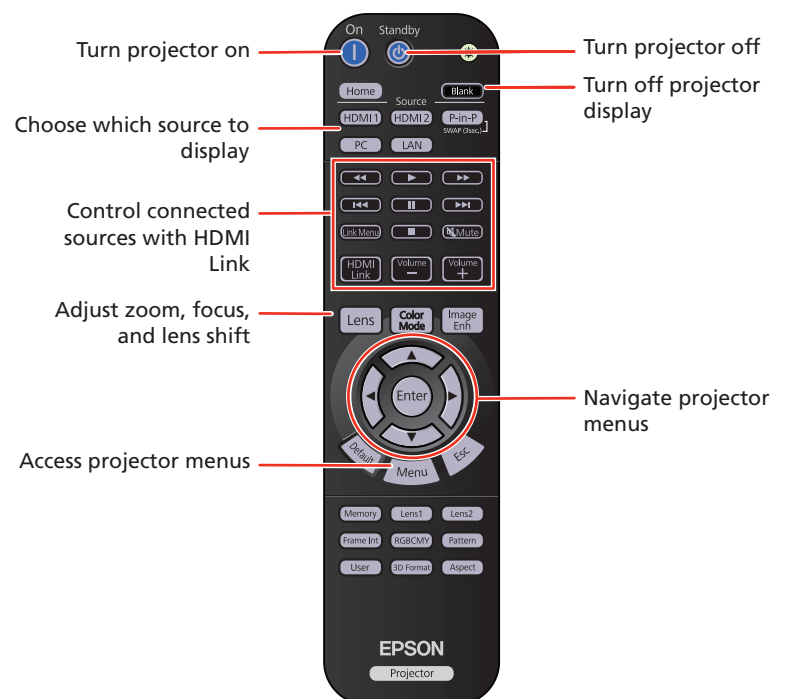
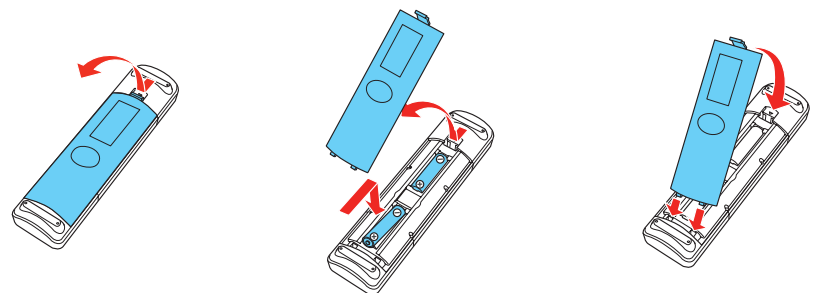

For more information on using the remote control, see the online *User's Guide*.



Adjust the image

- 1 Press the **Pattern** button on the remote control to display a test pattern.

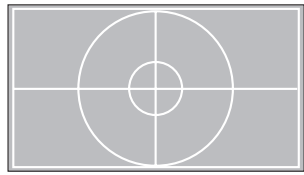

- 2 To raise the image or correct a tilted image, adjust the front feet as shown below.

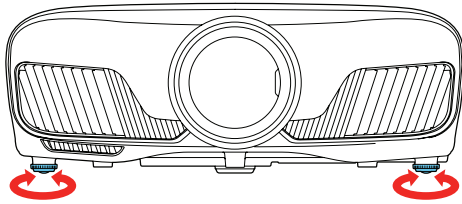

- 3 Press the **Lens** button on the remote control and use the ◀ and ▶ buttons to focus the image.

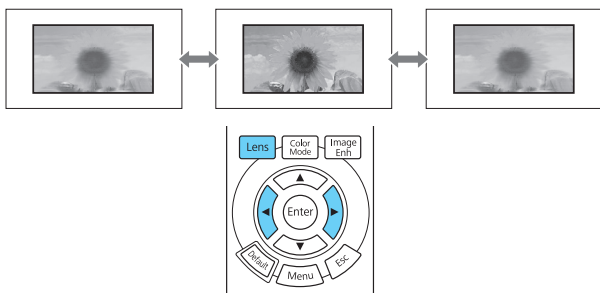

- 4 Press the **Lens** button on the remote control again and use the ◀ and ▶ buttons to reduce or enlarge the image.

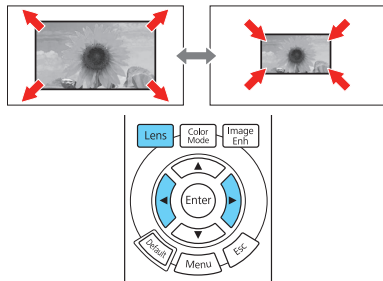

- 5 Press the **Lens** button on the remote control again and use the ▲, ▼, ◀, and ▶ buttons to reposition the image.

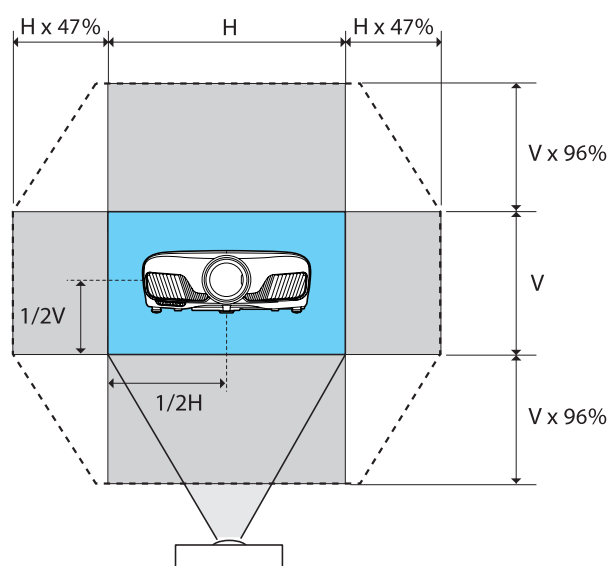

- 6 If your image looks like or , you can use the ◀ buttons on the projector to correct this.

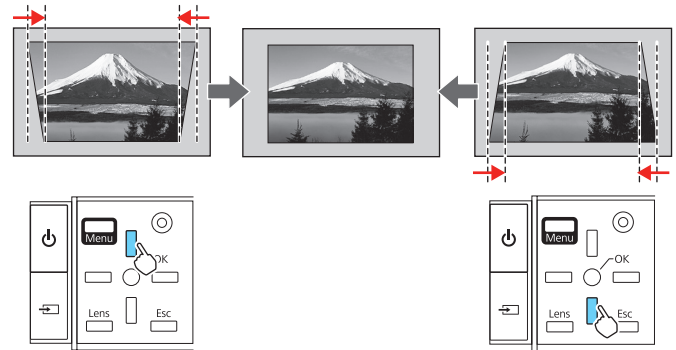

Note: Using the keystone adjustment can affect the size and effective resolution of your image. If possible, change the position of your projector to eliminate the keystone effect and use the lens shift option to position the image as necessary.

- 7 Press **Esc** to exit.

Viewing 3D images

To view 3D content, you must first connect a 3D-compatible video device to one of the HDMI ports on your projector. You also need a pair of Epson® (part number V12H548006) or Epson-compatible RF 3D active shutter glasses.

- 1 Turn on and begin playback on the 3D-compatible video device.

Note: Make sure you set the video device to play content in 3D mode.

- 2 Slide the power switch on your 3D glasses to the **On** position.

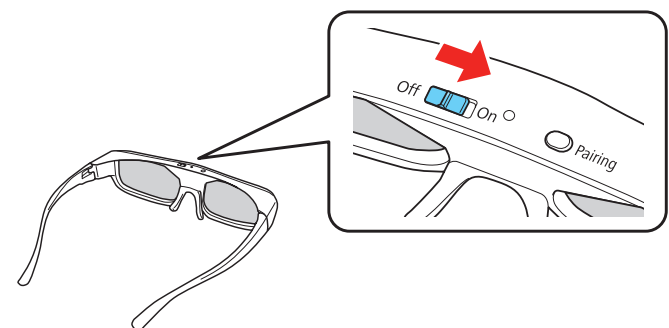

Note: If the glasses don't automatically display 3D content, you may need to pair them with the projector. Move the glasses within 10 feet (3 m) of the projector, then press and hold the **Pairing** button on the 3D glasses for at least 3 seconds. The status light on the glasses will alternately flash green and red, then remain green for 10 seconds if pairing is successful.

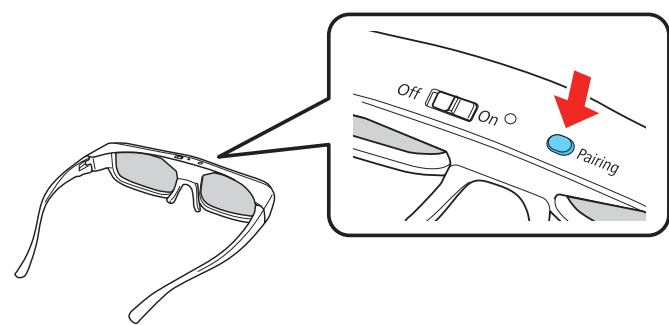



You can also automatically convert 2D HDMI content to 3D. To enable the 2D-to-3D Conversion option, press the **Menu** button on the projector or remote control. Select **Signal** and press **Enter**, then select **3D Setup** and press **Enter**. Select **2D-to-3D Conversion** and press **Enter**. Select the **Weak**, **Medium**, or **Strong** setting, then press **Enter**.

See the online *User's Guide* for more information on adjusting 3D images.

Troubleshooting

If you see a blank screen or the **No signal** message after turning on your video device or computer, check the following:

- Make sure the  power light on the projector is blue and not flashing.
- Press the  button on the projector or one of the Source buttons on the remote control to switch to the correct image source, if necessary.
- On some Windows® laptops, you may need to hold down the **Fn** key and press **F7** or the function key that lets you display on an external monitor. It may be labeled **CRT/LCD** or have an icon such as .
- On Windows 7 or later, hold down the Windows key and press **P** at the same time, then click **Duplicate**.
- If you're using a Mac laptop, open **System Preferences** and select **Displays**. Click the **Arrangement** tab and select the **Mirror Displays** checkbox.

If 3D images aren't displaying properly, check the following:

- Press the **Menu** button, then select **Signal > 3D Setup > 3D Display** and make sure that the **3D** option is selected.
- Make sure that you are within the 3D viewing range. See "Choose a location" on the front of this sheet or the online *User's Guide* for more information.
- Check that your 3D glasses have not entered standby mode. Slide the power switch on the 3D glasses to the **Off** position, then back to the **On** position.
- Check that your video device and media are both 3D-compatible. Refer to the documentation that came with your video device for more information.

Where to get help

Manuals

For more information about using the projector, click the icons on your desktop to access the online manuals (requires an Internet connection). If you don't see icon links to the manuals, you can install them from the projector CD or go to the Epson website, as described below.

Telephone support services

To use the Epson® PrivateLine® Support service, call (800) 637-7661. This service is available for the duration of your warranty period. You may also speak with a support specialist by calling (562) 276-4394 (US) or (905) 709-3839 (Canada).

Support hours are 6 AM to 8 PM, Pacific Time, Monday through Friday, and 7 AM to 4 PM, Pacific Time, Saturday. Days and hours of support are subject to change without notice. Toll or long distance charges may apply.

Internet support

Visit www.epson.com/support (U.S.) or www.epson.ca/support (Canada) for solutions to common problems. You can download utilities and documentation, get FAQs and troubleshooting advice, or e-mail Epson.

Registration

Register today to get product updates and exclusive offers. You can use the CD included with your projector or register online at www.epson.com/webreg.

Optional accessories

For a list of optional accessories, see the online *User's Guide*.

You can purchase RF 3D glasses (part number V12H548006) or other accessories from an Epson authorized reseller. To find the nearest reseller, call 800-GO-EPSON (800-463-7766). Or you can purchase online at www.epsonstore.com (U.S. sales) or www.epson.ca (Canadian sales).

Notices

Bluetooth Safety and Specifications

Contains Bluetooth module model: DBUB-E207

This document provides safety instructions and describes the specifications. Read this document carefully before use to ensure your safety and product performance.

U.S.

Contains FCC ID: BKMAE-E207

This device complies with Part 15 of the FCC Rules. Operation is subject to the following two conditions: (1) This device may not cause harmful interference, and (2) this device must accept any interference received, including interference that may cause undesired operation.

This equipment has been tested and found to comply with the limits for a Class B digital device, pursuant to Part 15 of the FCC Rules. These limits are designed to provide reasonable protection against harmful interference in a residential installation. This equipment generates, uses and can radiate radio frequency energy and, if not installed and used in accordance with the instructions, may cause harmful interference to radio communications. However, there is no guarantee that interference will not occur in a particular installation. If this equipment does cause harmful interference to radio or television reception, which can be determined by turning the equipment off and on, the user is encouraged to try to correct the interference by one of the following measures:

- Reorient or relocate the receiving antenna.
- Increase the separation between the equipment and receiver.
- Connect the equipment into an outlet on a circuit different from that to which the receiver is connected.
- Consult the dealer or an experienced radio/TV technician for help.

This transmitter must not be co-located or operating in conjunction with any other antenna or transmitter.

Radiation Exposure Statement:

This equipment complies with FCC radiation exposure limits set forth for an uncontrolled environment. This equipment should be installed and operated with minimum distance 7.9 inches (20 cm) between the radiator and your body.

Canada

Contains IC: 1052D-E207

This Class B digital apparatus complies with RSS-102 of the IC radio frequency (RF) Exposure rules.

This device complies with Industry Canada license-exempt RSS standards. Operation is subject to the following two conditions: (1) This device may not cause harmful interference, and (2) this device must accept any interference received, including interference that may cause undesired operation.

This transmitter must not be co-located or operating in conjunction with any other antenna or transmitter.

CAN ICES-3(B) / NMB-3(B)

Radiation Exposure Statement:

This equipment complies with IC RSS-102 radiation exposure limits set forth for an uncontrolled environment. This equipment should be installed and operated with minimum distance 20 cm (7.9 inches) between the radiator and your body.

Declaration of Conformity

According to 47CFR, Part 2 and 15, Class B Personal Computers and Peripherals; and/or CPU Boards and Power Supplies used with Class B Personal Computers.

We: Epson America, Inc.
Located at: 3840 Kilroy Airport Way
MS: 3-13
Long Beach, CA 90806
Telephone: (562) 981-3840

Declare under sole responsibility that the product identified herein, complies with 47CFR Part 2 and 15 of the FCC rules as a Class B digital device. Each product marketed, is identical to the representative unit tested and found to be compliant with the standards. Records maintained continue to reflect the equipment being produced can be expected to be within the variation accepted, due to quantity production and testing on a statistical basis as required by 47CFR 2.909. Operation is subject to the following two conditions: (1) this device may not cause harmful interference, and (2) this device must accept any interference received, including interference that may cause undesired operation.

Trade Name: Epson
Type of Product: LCD Projector
Model: H715A
Marketing Name: Home Cinema 4000

Epson America, Inc. Limited Warranty

Two-Year Projector Limited Warranty and 90-Day Lamp Limited Warranty

What Is Covered: Epson America, Inc. ("Epson") warrants to the original retail purchaser of the Epson projector product enclosed with this limited warranty statement that the product, if purchased new and operated in the United States, Canada, or Puerto Rico will be free from defects in workmanship and materials for a period of two years from the date of original purchase. This limited warranty applies only to the projector and not to the projector lamp, which carries a limited warranty period of ninety days from the date of original purchase. For warranty service, you may be required to provide proof of the date of original purchase.

What Epson Will Do To Correct Problems: If your product requires service during the limited warranty period, please call Epson at the number on the bottom of this statement and be prepared to provide the model, serial number, and, if required, date of original purchase. If Epson confirms that warranty service is required, Epson will, at its option, repair or replace the defective unit, without charge for parts or labor. If Epson authorizes an exchange for the defective unit, Epson will ship a replacement product to you, freight prepaid, so long as you use an address in the United States, Canada, or Puerto Rico. You are responsible for securely packaging the defective unit and returning it to Epson within five working days of receipt of the replacement. Epson requires a debit or a credit card number to secure the cost of the replacement product in the event that you fail to return the defective one. If Epson authorizes repair instead of exchange, Epson will direct you to send your product to Epson or its authorized service center, where the product will be repaired and sent back to you. You are responsible for packing the product and for all postage or shipping costs to and from the Epson authorized service center. When warranty service involves the exchange of the product or of a part, the item replaced becomes Epson property. The exchanged product or part may be new or refurbished to the Epson standard of quality. If service cannot be provided on the product for any reason and Epson no longer sells the same model, Epson will replace your product with a model of equal or superior value. Replacement products or parts assume the remaining warranty period of the original product. If Epson replaces the lamp as part of the warranty service, the replacement lamp carries the limited 90-day warranty stated above.

What This Warranty Does Not Cover: This warranty covers only normal use in the United States, Canada, or Puerto Rico.

This warranty does not cover the following:

- Excessive continual use
- Consumables such as filters
- Installation or removal
- Cosmetic damage caused by handling or normal wear and tear during usage
- Damage caused by failure to properly maintain the projector (see your online User's Guide for details)
- Damage caused by interaction with non-Epson products, such as add-in cards or cables
- Any problem resulting from misuse, abuse, improper installation, neglect, improper shipping, disasters such as fire, flood, and lightning, improper electrical current, software problems, exposure to chemical smoke, or excessive humidity
- Any problem resulting from service by other than Epson or an Epson Authorized Servicer

Epson is not responsible for warranty service should the Epson label or logo or the rating label or serial number be removed. This warranty is not transferrable. Epson is not responsible for your data or applications, which cannot be restored and should be backed up by you. Postage, insurance, or shipping costs incurred in presenting your Epson product for carry-in warranty service are your responsibility. If a claimed defect cannot be identified or reproduced in service, you will be held responsible for costs incurred.

DISCLAIMER OF OTHER WARRANTIES: THE WARRANTY AND REMEDY PROVIDED ABOVE ARE EXCLUSIVE AND IN LIEU OF ALL OTHER EXPRESS OR IMPLIED WARRANTIES INCLUDING, BUT NOT LIMITED TO, THE IMPLIED WARRANTIES OF MERCHANTABILITY, NONINFRINGEMENT OR FITNESS FOR A PARTICULAR PURPOSE. SOME LAWS DO NOT ALLOW THE EXCLUSION OF IMPLIED WARRANTIES. IF THESE LAWS APPLY, THEN ALL EXPRESS AND IMPLIED WARRANTIES ARE LIMITED TO THE WARRANTY PERIOD IDENTIFIED ABOVE. UNLESS STATED HEREIN, ANY STATEMENTS OR REPRESENTATIONS MADE BY ANY OTHER PERSON OR FIRM ARE VOID.

EXCLUSION OF DAMAGES; EPSON'S MAXIMUM LIABILITY: IN NO EVENT SHALL EPSON OR ITS AFFILIATES BE LIABLE FOR ANY SPECIAL, INCIDENTAL, OR CONSEQUENTIAL DAMAGES OR ANY LOST PROFITS RESULTING FROM THE USE OR INABILITY TO USE THE EPSON PRODUCT, WHETHER RESULTING FROM BREACH OF WARRANTY OR ANY OTHER LEGAL THEORY. IN NO EVENT SHALL EPSON OR ITS AFFILIATES BE LIABLE FOR DAMAGES OF ANY KIND IN EXCESS OF THE ORIGINAL RETAIL PURCHASE PRICE OF THE PRODUCT.

Arbitration, Governing Laws: Any dispute, claim or controversy arising out of or relating to this warranty shall be determined by arbitration in Los Angeles County, California before a single arbitrator. The arbitration shall be administered by JAMS pursuant to its Comprehensive Arbitration Rules and Procedures. Judgment on the award may be entered in any court having jurisdiction. Any action must be brought within three months of the expiration of the warranty. This clause shall not preclude parties from seeking provisional remedies in aid of arbitration from a court of appropriate jurisdiction. This warranty shall be construed in accordance with the laws of the State of California, except this arbitration clause which shall be construed in accordance with the Federal Arbitration Act.

Other Rights You May Have: This warranty gives you specific legal rights, and you may also have other rights which vary from jurisdiction to jurisdiction. Some jurisdictions do not allow limitations on how long an implied warranty lasts, or allow the exclusion or limitation of incidental or consequential damages, so the above limitations or exclusions may not apply to you.

In Canada, warranties include both warranties and conditions.

To find the Epson Authorized Reseller nearest you, please visit: www.epson.com in the U.S. or www.epson.ca in Canada.

To find the Epson Customer Care Center nearest you, please visit www.epson.com/support in the U.S. or www.epson.ca/support in Canada.

To contact the Epson ConnectionSM, please call (800) 637-7661 or (562) 276-4394 in the U.S. and (905) 709-3839 in Canada or write to Epson America, Inc., P.O. Box 93012, Long Beach, CA 90809-3012.

EPSON
EXCEED YOUR VISION



EPSON is a registered trademark, and EPSON Exceed Your Vision is a registered logomark of Seiko Epson Corporation. Epson Connection is a service mark and PrivateLine is a registered trademark of Epson America, Inc.

Mac is a trademark of Apple Inc., registered in the US and other countries.

General Notice: Other product names used herein are for identification purposes only and may be trademarks of their respective owners. Epson disclaims any and all rights in those marks.

This information is subject to change without notice.

© 2017 Epson America, Inc., 3/17

Printed in XXXXXX

CPD-53682

Free Manuals Download Website

<http://myh66.com>

<http://usermanuals.us>

<http://www.somanuals.com>

<http://www.4manuals.cc>

<http://www.manual-lib.com>

<http://www.404manual.com>

<http://www.luxmanual.com>

<http://aubethermostatmanual.com>

Golf course search by state

<http://golfingnear.com>

Email search by domain

<http://emailbydomain.com>

Auto manuals search

<http://auto.somanuals.com>

TV manuals search

<http://tv.somanuals.com>