

**BrightLink[®] 475Wi/480i/485Wi
User's Guide**

Contents

BrightLink 475Wi/480i/485Wi User's Guide	11
Introduction to Your Projector	12
Projector Features.....	12
Product Box Contents.....	13
Additional Components	15
Optional Equipment and Replacement Parts.....	15
Warranty and Registration Information	17
Notations Used in the Documentation	17
Where to Go for Additional Information	17
Projector Part Locations	18
Projector Parts - Front/Top	18
Projector Parts - Side.....	19
Projector Parts - Interface Panel.....	20
Projector Parts - Base.....	22
Projector Parts - Control Panel	23
Projector Parts - Interactive Pens	24
Projector Parts - Remote Control.....	25
Setting Up the Projector	27
Projector Placement.....	27
Projector Setup and Installation Options	27
Projection Distance.....	29
Installing the Projector Feet.....	33
Removing and Attaching the Cable Cover	33
Projector Connections	34
Connecting to Computer Sources.....	35
Connecting to a Computer for USB Video and Audio.....	35
Connecting to a Computer for VGA Video	37
Connecting to a Computer for HDMI Video and Audio.....	37
Connecting to a Computer for Pen Use or USB Mouse Control.....	38
Connecting to a Computer for Sound.....	39

Connecting to Video Sources	39
Connecting to an HDMI Video Source	40
Connecting to a Component-to-VGA Video Source	40
Connecting to a Composite Video Source	41
Connecting to an S-Video Video Source	41
Connecting to a Video Source for Sound	42
Connecting to an External Computer Monitor	43
Connecting to External Speakers	43
Connecting a Microphone	44
Connecting to External USB Devices	45
USB Device Projection	45
Connecting a USB Device or Camera to the Projector	45
Selecting the Connected USB Source	46
Disconnecting a USB Device or Camera From the Projector	46
Connecting to a Document Camera	47
Installing Batteries in the Remote Control	47
Installing Batteries in the Pens	49
Using the Projector on a Network	51
Wired Network Projection	51
Connecting to a Wired Network	52
Selecting Wired Network Settings	52
Wireless Network Projection	55
Installing the Wireless LAN Module	56
Using Quick Wireless Connection (Windows Only)	57
Selecting Wireless Network Settings Manually	58
Wireless LAN Menu Settings	61
Selecting Wireless Network Settings in Windows	62
Selecting Wireless Network Settings in Mac OS X	62
Setting Up Wireless Network Security	63
Wireless Security Menu Settings	64
Setting Up Projector Network E-Mail Alerts	65
Network Projector E-mail Alert Messages	66
Setting Up Monitoring Using SNMP	66

Controlling a Networked Projector Using a Web Browser	67
Crestron RoomView Support.....	69
Setting Up Crestron RoomView Support	69
Controlling a Networked Projector Using Crestron RoomView	70
Using Basic Projector Features	72
Turning On the Projector	72
Turning Off the Projector	74
Selecting the Language for the Projector Menus.....	75
Adjusting the Image Height	76
Image Shape.....	77
Correcting Image Shape with the Keystone Buttons	78
Correcting Image Shape with Quick Corner	80
Resizing the Image with the Wide and Tele Buttons	82
Adjusting the Image Position	82
Focusing the Image.....	83
Remote Control Operation	84
Using the Remote Control as a Wireless Mouse	86
Using the Remote Control as a Presentation Pointer	87
Selecting an Image Source	87
Projection Modes	88
Changing the Projection Mode Using the Remote Control	89
Changing the Projection Mode Using the Menus.....	89
Image Aspect Ratio	90
Changing the Image Aspect Ratio	91
Available Image Aspect Ratios	91
Color Mode.....	92
Changing the Color Mode.....	93
Available Color Modes.....	93
Turning On Auto Iris.....	94
Controlling the Volume with the Volume Buttons.....	95
Projecting a Slide Show	95
Slideshow Features	96
Supported Slideshow File Types	96

Starting a Slide Show	97
Slideshow Display Options	98
Adjusting Projector Features	100
Shutting Off the Picture and Sound Temporarily	100
Stopping Video Action Temporarily	100
Zooming Into and Out of Images	101
Projector Security Features.....	102
Password Security Types	102
Setting a Password	103
Selecting Password Security Types.....	104
Entering a Password to Use the Projector	104
Saving a User's Logo Image to Display.....	106
Locking the Projector's Buttons	107
Unlocking the Projector's Buttons	108
Installing a Security Cable	108
Creating a User Pattern to Display	109
Using the Interactive Pens.....	110
Using the Pens	110
Calibrating Automatically	112
Calibrating Manually	114
Using BrightLink With a Computer	117
Adjusting the Pen Operation Area	118
Easy Interactive Tools	120
Easy Interactive Tools System Requirements	120
Installing Easy Interactive Tools	121
Starting and Exiting Easy Interactive Tools	123
Using the Easy Interactive Tools for Interactive Mode.....	125
Easy Interactive Tools for Interactive Mode	125
Using the On-Screen Keyboard	126
Using a Document Camera With Easy Interactive Tools.....	127
Using the Magnifier	128
Using Easy Interactive Annotation Tools	129
Easy Interactive Annotation Tools	129

Selecting Line Width and Color With Easy Interactive Tools.....	131
Using the Easy Interactive Tools for Whiteboard Mode	132
Easy Interactive Tools for Whiteboard Mode	132
Using the Shapes Tool in Whiteboard Mode.....	133
Using Easy Interactive Tools for Saving, Printing, and More	134
Easy Interactive Tools for Saving, Printing, and More.....	134
Working With the Page List.....	135
Saving Your Pages	136
Selecting Language and General Settings.....	139
Windows Tablet PC and Ink Tools	140
Enabling Windows Tablet PC and Ink Features	141
Using Windows Tablet PC and Ink Features	142
Using BrightLink Without a Computer	143
Using the Built-in Toolbar	144
Built-in Tools for Use Without a Computer.....	144
Zooming Images Using the Built-in Toolbar.....	147
Using the Built-in Whiteboard Mode	147
Changing Pen Width and Color Using the Built-in Toolbar	148
Adjusting the Menu Settings	149
Using the Projector's Menus.....	149
Image Quality Settings - Image Menu	150
Input Signal Settings - Signal Menu	152
Projector Feature Settings - Settings Menu.....	154
Projector Setup Settings - Extended Menu	157
Projector Network Settings - Network Menu.....	161
Projector Information Display - Info Menu	163
Event ID Code List.....	164
Projector Reset Options - Reset Menu.....	165
Maintaining and Transporting the Projector	167
Projector Maintenance	167
Cleaning the Projection Window.....	167
Cleaning the Obstacle Sensor.....	168
Cleaning the Projector Case.....	169

Air Filter and Vent Maintenance	169
Cleaning the Air Filter and Vents.....	169
Replacing the Air Filter.....	170
Projector Lamp Maintenance.....	175
Replacing the Lamp	175
Resetting the Lamp Timer.....	179
Replacing the Remote Control Batteries	180
Replacing the Pen Batteries	182
Replacing the Pen Tips.....	183
Transporting the Projector.....	184
Solving Problems	185
Projection Problem Tips	185
Projector Light Status.....	185
Using the Projector Help Displays	188
Solving Image or Sound Problems	188
Solutions When No Image Appears.....	189
Solutions When Image is Incorrect Using the USB Display Function	190
Solutions When "No Signal" Message Appears.....	190
Displaying From a PC Laptop	191
Displaying From a Mac Laptop	191
Solutions When "Not Supported" Message Appears	191
Solutions When Only a Partial Image Appears.....	192
Solutions When the Image is Not Rectangular	192
Solutions When the Image Contains Noise or Static	193
Solutions When the Image is Fuzzy or Blurry	193
Solutions When the Image Brightness or Colors are Incorrect	194
Solutions When There is No Sound or Low Volume	195
Solutions to Microphone Problems.....	195
Solving Projector or Remote Control Operation Problems	196
Solutions to Projector Power or Shut-Off Problems.....	196
Solutions to Problems with the Remote Control	196
Solutions to Password Problems.....	197
Solving Interactive Pen Problems	197

Solutions When "Hardware Device Not Found" Message Appears	198
Solutions When "Error Occurred in the Easy Interactive Function" Message Appears.....	198
Solutions When the Interactive Pens Do Not Work.....	198
Solutions When Manual Calibration is Difficult	199
Solutions When the Built-In Toolbar Does Not Work	199
Solutions When the Interactive Pen Position Is Not Accurate.....	200
Solutions When the Interactive Pens Are Slow or Difficult to Use.....	200
Solutions When the Interactive Pens Cause Interference or Unwanted Effects	201
Solutions When Network Alert E-Mails are Not Received	201
Where to Get Help.....	201
Technical Specifications	203
General Projector Specifications	203
Projector Lamp Specifications.....	205
Remote Control Specifications	205
Projector Dimension Specifications.....	206
Projector Electrical Specifications	206
Projector Environmental Specifications.....	207
Projector Safety and Approvals Specifications.....	207
Supported Video Display Formats.....	208
USB Display System Requirements.....	210
Notices	211
Recycling.....	211
Important Safety Information	211
Important Safety Instructions.....	212
Restriction of Use	214
FCC Compliance Statement.....	215
Wireless Telegraphy Act Regulations	216
Trademarks	216
Software Copyright.....	216
Copyright Notice.....	258
A Note Concerning Responsible Use of Copyrighted Materials.....	259
Copyright Attribution	259

BrightLink 475Wi/480i/485Wi User's Guide

Welcome to the BrightLink 475Wi/480i/485Wi *User's Guide*.

Introduction to Your Projector

Refer to these sections to learn more about your projector and this manual.

[Projector Features](#)

[Notations Used in the Documentation](#)

[Where to Go for Additional Information](#)

[Projector Part Locations](#)

Projector Features

BrightLink 475Wi/480i/485Wi projectors include these special features:

Unique interactive functions

- Annotation with or without a computer
- Annotation with two pens at the same time
- Enhanced Easy Interactive toolbar for Windows and Mac

Ultra short throw projection system

- Project an 87-inch (221-cm) image (WXGA) from just 9.1 inches (231 mm) away
- Easily mounted on a wall or table for fast, low-cost installations
- Can be mounted vertically to create an interactive workspace directly on a table surface
- Can be placed on a table or desk for portability
- Reduced shadow interference and glare

Bright, high-resolution images

- BrightLink 475Wi: Up to 2600 lumens of brightness (white light output and color light output)
BrightLink 480i: Up to 3000 lumens of brightness (white light output and color light output)
BrightLink 485Wi: Up to 3100 lumens of brightness (white light output and color light output)
- BrightLink 480i: Native resolution of 1024 × 768 pixels (XGA)
BrightLink 475Wi/485Wi: Native resolution of 1280 × 800 pixels (WXGA)

Flexible connectivity

- HDMI port for computer or video device connection
- Plug-and-play 3-in-1 USB projection, audio, and mouse control for instant setup

- Wired network support for projection
- Projector monitoring and control via remote network computer
- Optional wireless network support, including video and audio transfer
- PC Free photo slide shows via connected USB memory devices or EPSON document camera
- Dual VGA ports for connections by multiple presenters
- Port for connecting an external monitor
- Port for connecting a microphone

Innovative display and operation features

- Low total cost of ownership with long-life projector lamp and high-efficiency air filter
- High digital zoom ratio for larger images in shorter projection distances
- 3000:1 contrast ratio and Auto Iris control for sharp, detailed images
- Built-in closed captioning decoder
- Powerful 16 W speaker system with audio out port for connecting external speakers
- Epson's Instant Off and Direct Power On features for quick setup and shut down
- Support for Crestron RoomView network monitoring systems
- Network message broadcast system to project timely messages to all networked projectors

[Product Box Contents](#)

[Additional Components](#)

[Optional Equipment and Replacement Parts](#)

[Warranty and Registration Information](#)

Parent topic: [Introduction to Your Projector](#)

Related concepts

[Projector Part Locations](#)

Product Box Contents

Save all the packaging in case you need to ship the projector. Always use the original packaging (or equivalent) when shipping.

Make sure your projector box included all of these parts:

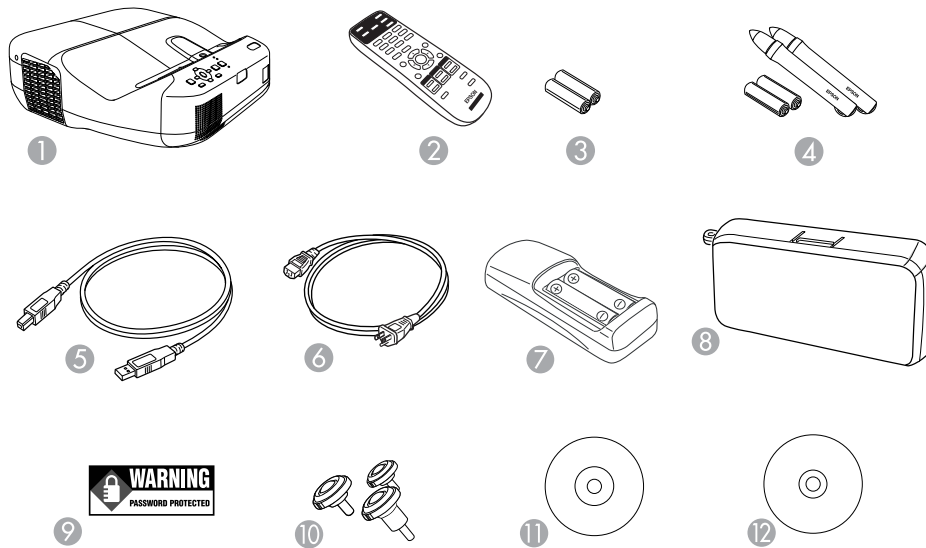

- 1 Projector
- 2 Remote control
- 3 Remote control batteries (two AA alkaline)
- 4 Pens and batteries (one AA alkaline battery for each pen)
- 5 USB cable
- 6 Power cord
- 7 Battery charger with 2 AA rechargeable pen batteries
- 8 Pen tray
- 9 Password Protected sticker
- 10 Projector feet
- 11 Projector software CD-ROM (for network usage)
- 12 Projector software for Easy Interactive Function CD-ROM

Parent topic: [Projector Features](#)

Related concepts

[Projector Connections](#)

Additional Components

Depending on how you plan to use the projector, you may need to obtain the following additional components:

- To receive an S-Video signal, you need an S-Video cable compatible with your device. See your local computer or electronics dealer for purchase information.
- To receive a component video signal, you need a D-sub, 15-pin, component-to-VGA video cable. You can purchase one from Epson or an authorized EPSON reseller.
- To receive an HDMI signal, you need a compatible HDMI cable. See your local computer or electronics dealer for purchase information.

Note: To connect a Mac that includes only a Mini DisplayPort or Mini-DVI port for video output, you need to obtain an adapter that allows you to connect to the projector's **HDMI** port. Contact Apple for compatible adapter options. Older Mac computers (2009 and earlier) may not support audio through the **HDMI** port.

- If you did not purchase a mount that included a VGA cable, you need a VGA computer cable. You can purchase one from Epson or an authorized EPSON reseller.

Note: To connect a Mac that includes only a Mini DisplayPort or Mini-DVI port for video output, you need to obtain an adapter that allows you to connect to the projector's VGA video port. Contact Apple for compatible adapter options.

Parent topic: [Projector Features](#)

Optional Equipment and Replacement Parts

You can purchase screens, other optional accessories, and replacement parts from an EPSON authorized reseller. To find the nearest reseller, call 800-GO-EPSON (800-463-7766). Or you can purchase online at www.epsonstore.com (U.S. sales) or www.epson.ca (Canadian sales).

Epson offers the following optional accessories and replacement parts for your projector:

Option or part	Part number
Genuine EPSON replacement lamp (ELPLP71)	V13H010L71

Option or part	Part number
Air filter replacement (ELPAF40)	V13H134A40
Wireless LAN module (ELPAP07)	V12H418P12
Quick Wireless Connection USB key (ELPAP08)	V12H005M08
Additional interactive pen (ELPPN03A/ELPPN03B)	V12H522001/V12H523001
Replacement set of 6 pen tips (ELPPS01)	V12H524001
USB extension cable	V12H525001
EPSON DC-11 document camera (ELPDC11)	V12H377020
EPSON DC-06 document camera (ELPDC06)	V12H321005
PowerLite Pilot (ELPCB01)	V12H443020
Wireless Pendant Microphone (ELPMC02)	V12H4430M2
Active speakers (ELPSP02)	V12H467020
On Wall Cable Management Kit	ELPCK01
Kensington security lock	ELPSL01
90-inch whiteboard	V12H468002
96-inch whiteboard	V12H468001
6 ft (1.8 m) VGA computer cable (ELPKC02)	F3H982-06
10 ft (3.0 m) VGA computer cable (ELPKC09)	F3H982-10
25 ft (20 m) VGA computer cable (ELPKC10)	F3H982-25
HD-TV cable	ELPKC22
Component-to-VGA video cable (ELPKC19)	V12H005C19
16:10 Height-adjustable cart for ultra-short throw projectors	V12H457008
4:3 Height-adjustable cart for ultra-short throw projectors	V12H457007
Lock box for height-adjustable cart	V12H457004
Rear laptop and keyboard tray for height-adjustable cart	V12H457005
Side laptop and keyboard tray for height-adjustable cart	V12H457006
16:10 Height-adjustable wall mount for ultra-short throw projectors	V12H457010

Option or part	Part number
4:3 Height-adjustable wall mount for ultra-short throw projectors	V12H457019
1-Year Extended Depot Repair Service Plan	EPPFPA1
1-Year Extended Exchange Warranty	EPPEXA1
2-Year Extended Depot Repair Service Plan	EPPFPA2

Parent topic: [Projector Features](#)

Warranty and Registration Information

Your projector comes with a basic warranty that lets you project with confidence. For details, see the warranty brochure that came with your projector.

In addition, Epson offers free Extra Care Road Service. In the unlikely event of an equipment failure, you won't have to wait for your unit to be repaired. Instead, Epson will ship you a replacement unit anywhere in the United States, Canada, or Puerto Rico. See the Extra Care Road Service brochure for details.

Register your product online using the projector CD or at this site: www.epson.com/webreg

Registering also lets you receive special updates on new accessories, products, and services.

Parent topic: [Projector Features](#)

Notations Used in the Documentation

Follow the guidelines in these notations as you read your documentation:

- **Warnings** must be followed carefully to avoid bodily injury.
- **Cautions** must be observed to avoid damage to your equipment.
- **Notes** contain important information about your projector.
- **Tips** contain additional projection information.

Parent topic: [Introduction to Your Projector](#)

Where to Go for Additional Information

Need quick help on using your projector during a presentation? Here's where to look for help:

- Built-in help system
 - Press the **Help** button on the remote control or projector to get quick solutions to common problems.
- www.epson.com/support (U.S) or www.epson.ca/support (Canada)

View FAQs (frequently asked questions) and e-mail your questions to Epson technical support 24 hours a day.

- If you still need help after checking this manual and the sources listed above, you can use the EPSON PrivateLine Support service to get help fast. For details, see "Where to Get Help".

Parent topic: [Introduction to Your Projector](#)

Related references

[Where to Get Help](#)

Projector Part Locations

Check the projector part illustrations to learn about the parts on your projector.

[Projector Parts - Front/Top](#)

[Projector Parts - Side](#)

[Projector Parts - Interface Panel](#)

[Projector Parts - Base](#)

[Projector Parts - Control Panel](#)

[Projector Parts - Interactive Pens](#)

[Projector Parts - Remote Control](#)

Parent topic: [Introduction to Your Projector](#)

Projector Parts - Front/Top

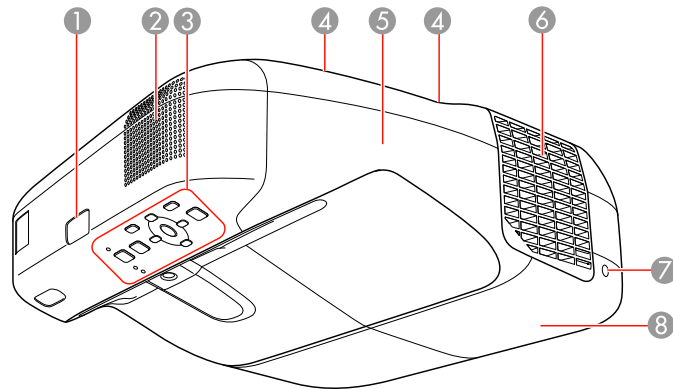

- 1 Remote control receiver
- 2 Speaker
- 3 Control panel
- 4 Cable cover screw
- 5 Cable cover
- 6 Exhaust vent
- 7 Lamp cover screw
- 8 Lamp cover

Parent topic: [Projector Part Locations](#)

Projector Parts - Side

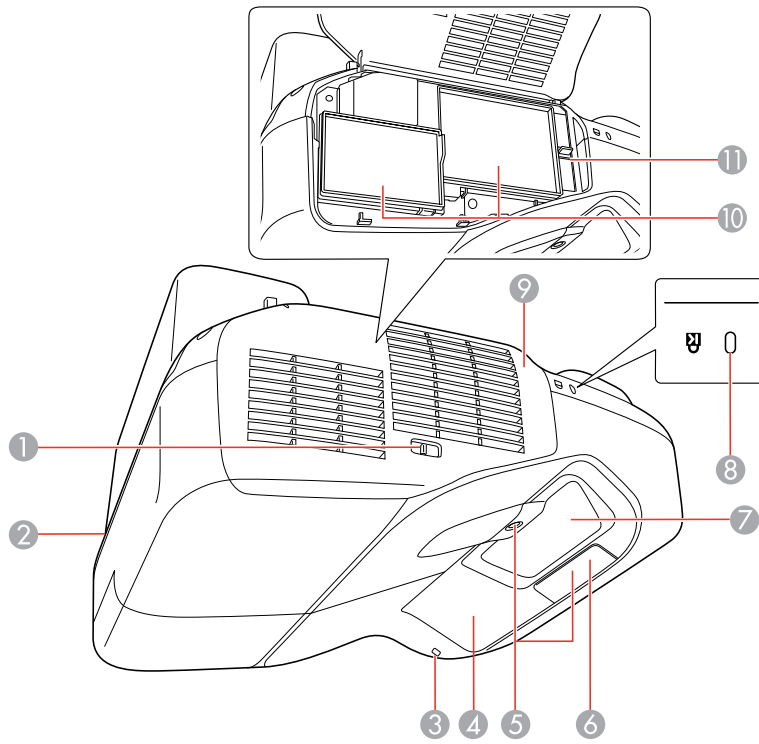

- 1 Filter cover switch
- 2 Security cable installation slot
- 3 Wireless LAN light
- 4 Interactive pen receiver
- 5 Obstacle sensor
- 6 Remote receiver
- 7 Projection window
- 8 Security lock port
- 9 Air filter cover
- 10 Air intake vent (air filter)
- 11 Focus lever

Parent topic: [Projector Part Locations](#)

Projector Parts - Interface Panel

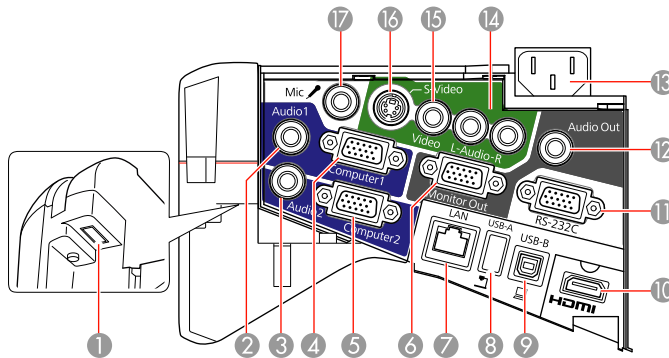

- 1 Optional wireless LAN unit slot
- 2 **Audio1** port
- 3 **Audio2** port
- 4 **Computer1** port

- 5 **Computer2** port
- 6 **Monitor Out** port
- 7 Network (**LAN**) port
- 8 **USB-A** port
- 9 **USB-B** port
- 10 **HDMI** port
- 11 **RS-232C** port
- 12 **Audio Out** port
- 13 Power inlet
- 14 **L-Audio-R** audio ports
- 15 **Video** port
- 16 **S-Video** port
- 17 **Mic** (microphone) port

Parent topic: [Projector Part Locations](#)

Projector Parts - Base

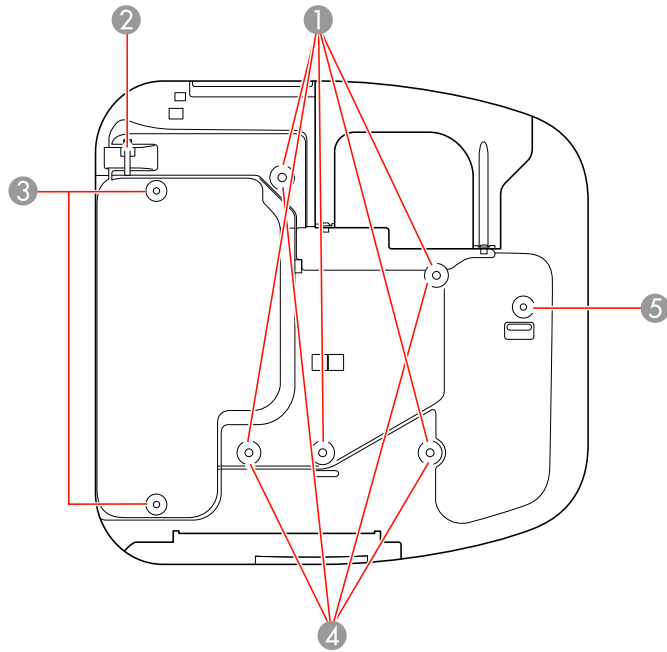

- 1 Ceiling mount holes (3)
- 2 Security cable attachment point
- 3 Rear foot attachment holes (2)
- 4 Wall mount plate holes (5)
- 5 Front foot attachment hole

Parent topic: [Projector Part Locations](#)

Projector Parts - Control Panel

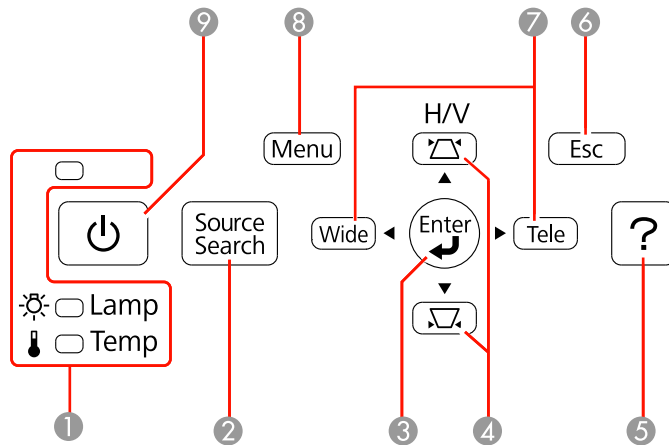

- 1 Projector status lights
- 2 **Source Search** button (searches for connected video sources)
- 3 **Enter** button (selects options)
- 4 Horizontal/Vertical keystone adjustment buttons (display the adjustment screen) and arrow buttons
- 5 **Help** button (accesses projector help information)
- 6 **Esc** button (cancels/exits functions)
- 7 **Wide/Tele** buttons (adjust projected image size), horizontal keystone adjustment buttons (adjust screen shape), and arrow buttons
- 8 **Menu** button (accesses projector menu system)
- 9 Power button

Parent topic: [Projector Part Locations](#)

Related references

[Projector Light Status](#)

Projector Parts - Interactive Pens

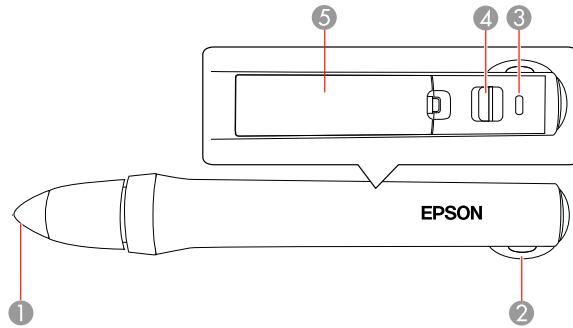

- 1 Pen tip
- 2 Attachment for optional strap or cord
- 3 Battery light
- 4 Power switch
- 5 Battery cover

Parent topic: [Projector Part Locations](#)

Projector Parts - Remote Control

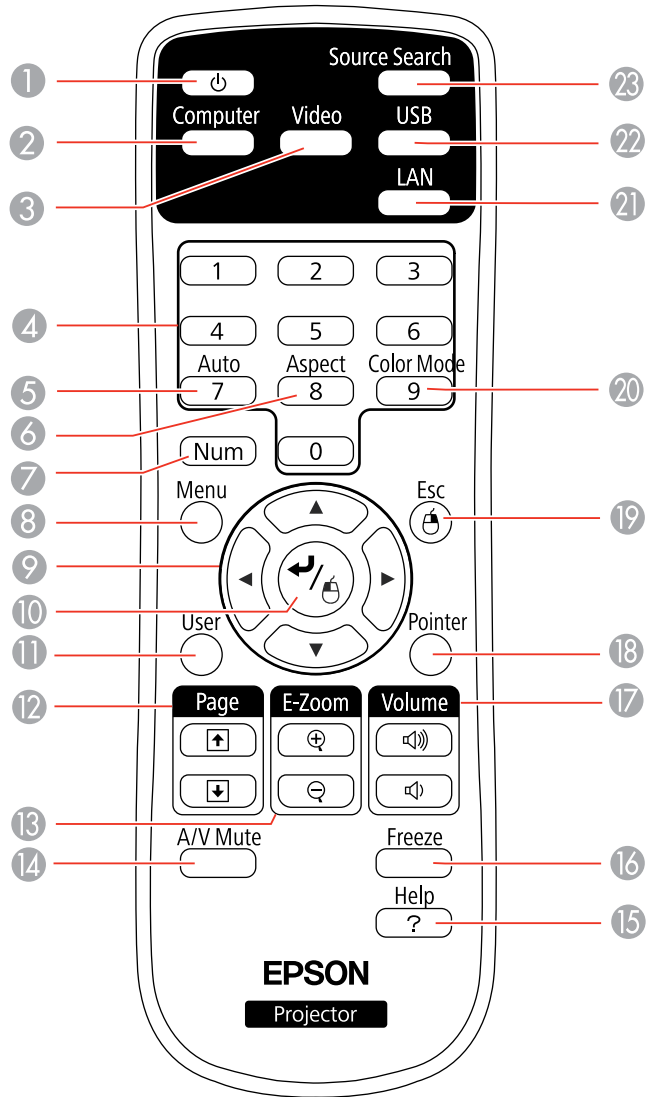

1 Power button

- 2 **Computer** button (cycles through connected computer sources)
- 3 **Video** button (cycles through connected video sources)
- 4 Numeric buttons (enter numbers)
- 5 **Auto** button (automatically adjusts position, tracking, and sync settings)
- 6 **Aspect** button (selects the image aspect ratio)
- 7 **Num** button (when held down, switches numeric buttons to number function)
- 8 **Menu** button (accesses projector menu system)
- 9 Arrow buttons (move through on-screen options and control wireless mouse functions)
- 10 Enter button (selects options and controls wireless mouse functions)
- 11 **User** button (customizable for different functions)
- 12 **Page** up/down buttons (control presentation slides)
- 13 **E-Zoom +/-** buttons (zoom into and out of the image)
- 14 **A/V Mute** button (turns off picture and sound)
- 15 **Help** button (accesses projector help information)
- 16 **Freeze** button (stops video action)
- 17 **Volume** up/down buttons (adjust speaker volume)
- 18 **Pointer** button (activates on-screen pointer)
- 19 **Esc** button (cancels/exits functions and controls wireless mouse functions)
- 20 **Color Mode** button (selects display modes)
- 21 **LAN** button
- 22 **USB** button (cycles through connected USB sources)
- 23 **Source Search** button (searches for connected sources)

Parent topic: [Projector Part Locations](#)

Setting Up the Projector

Follow the instructions in these sections to set up your projector for use.

[Projector Placement](#)

[Installing the Projector Feet](#)

[Removing and Attaching the Cable Cover](#)

[Projector Connections](#)

[Installing Batteries in the Remote Control](#)

[Installing Batteries in the Pens](#)

Projector Placement

Your ultra-short throw projector is designed to be installed on a wall or vertically on a table to create an interactive tabletop workspace.

You can also place the projector on a flat surface such as a desk or table to project in a portable setup.

Keep these considerations in mind as you select a projector location:

- Follow the instructions in the *Installation Guide* to install the projector using the included mounting equipment.
- Leave plenty of space around and under the projector for ventilation, and do not place it on top of or next to anything that could block the vents.
- Position the projector within reach of a grounded electrical outlet or extension cord.
- If the projector is not mounted, place it on a sturdy, level surface.

[Projector Setup and Installation Options](#)

[Projection Distance](#)

Parent topic: [Setting Up the Projector](#)

Projector Setup and Installation Options

You can set up or install your projector to view presentations in the following ways:

Mounted on the wall or ceiling

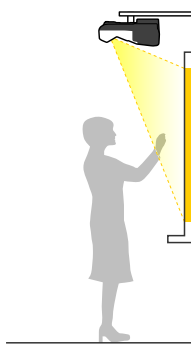

Mounted vertically on a table to create an interactive workspace.

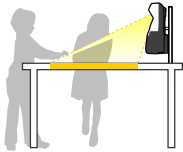

Front projection from a table or portable cart

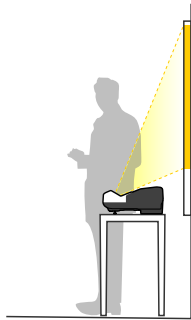

Wherever you set up the projector, make sure to position it squarely in front of the screen, not at an angle.

If you project from a table or portable cart, be sure to select correct **Projection** option in the projector's menu system.

Parent topic: [Projector Placement](#)

Projection Distance

The distance at which you place the projector from the screen determines the approximate size of the image. The image size increases the farther the projector is from the screen, but can vary depending on the zoom factor, aspect ratio, and other settings.

Use the tables here to determine approximately how far to place the projector from the screen based on the size of the projected image. (Conversion figures may have been rounded up or down.) For more detailed information and installation instructions, see the *Installation Guide*. You can also use the projector Throw Distance Calculator at www.epson.com/support (U.S.) or www.epson.ca/support (Canada).

BrightLink 480i

4:3 Aspect Ratio

Diagonal image size	Min. ceiling height	Image width	Image height	Min. projection distance	Distance from top of image to wall plate
56 inches	80 inches (202.1 cm)	44.8 inches (113.9 cm)	33.6 inches (85.3 cm)	2.5 inches (6.3 cm)	6.0 inches (15.2 cm)
60 inches	82 inches (209.1 cm)	48 inches (122.0 cm)	36 inches (91.4 cm)	3.5 inches (8.9 cm)	6.4 inches (16.1 cm)
70 inches	89 inches (226.9 cm)	56.0 inches (142.2 cm)	42 inches (106.7 cm)	6.1 inches (15.6 cm)	7.3 inches (18.6 cm)
77 inches	94 inches (239.2 cm)	61.6 inches (156.4 cm)	46.2 inches (117.3 cm)	8.0 inches (20.2 cm)	8.0 inches (20.3 cm)
80 inches	96 inches (244.6 cm)	64 inches (162.5 cm)	48 inches (121.9 cm)	8.8 inches (22.2 cm)	8.3 inches (21.1 cm)
90 inches	103 inches (262.3 cm)	72 inches (182.9 cm)	54 inches (137.2 cm)	11.4 inches (28.9 cm)	9.3 inches (23.5 cm)
93 inches	105 inches (267.5 cm)	74.4 inches (189.1 cm)	55.8 inches (141.7 cm)	12.2 inches (30.9 cm)	9.6 inches (24.2 cm)

16:9 Aspect Ratio

Diagonal image size	Min. ceiling height	Image width	Image height	Min. projection distance	Distance from top of image to wall plate
52 inches	75.8 inches (192.5 cm)	45.3 inches (115.1 cm)	25.5 inches (64.8 cm)	2.6 inches (6.7 cm)	10.3 inches (26.1 cm)
60 inches	81.2 inches (206.2 cm)	52.3 inches (132.8 cm)	29.4 inches (74.7 cm)	4.9 inches (12.5 cm)	11.8 inches (29.9 cm)
70 inches	88.0 inches (223.5 cm)	61.0 inches (155.0 cm)	34.3 inches (87.2 cm)	7.8 inches (19.7 cm)	13.7 inches (34.7 cm)
77 inches	92.7 inches (235.5 cm)	67.1 inches (170.5 cm)	37.8 inches (95.9 cm)	9.8 inches (24.8 cm)	15.0 inches (38.0 cm)
80 inches	94.7 inches (240.6 cm)	69.7 inches (177.1 cm)	39.2 inches (99.6 cm)	10.6 inches (27.0 cm)	15.5 inches (39.4 cm)
85 inches	98.1 inches (249.2 cm)	74.1 inches (188.2 cm)	41.7 inches (105.8 cm)	12.1 inches (30.6 cm)	16.5 inches (41.8 cm)

16:10 Aspect Ratio

Diagonal image size	Min. ceiling height	Image width	Image height	Min. projection distance	Distance from top of image to wall plate
53 inches	77.2 inches (196.1 cm)	44.9 inches (114.2 cm)	28.1 inches (71.3 cm)	2.5 inches (6.4 cm)	8.8 inches (22.3 cm)
60 inches	82.0 inches (208.4 cm)	50.9 inches (129.2 cm)	31.8 inches (80.8 cm)	4.5 inches (11.3 cm)	9.9 inches (25.1 cm)
70 inches	89.0 inches (226.0 cm)	59.4 inches (150.8 cm)	37.1 inches (94.2 cm)	7.2 inches (18.4 cm)	11.4 inches (29.1 cm)
75 inches	92.4 inches (234.7 cm)	63.6 inches (161.5 cm)	39.7 inches (101.0 cm)	8.6 inches (21.9 cm)	12.2 inches (31.0 cm)
80 inches	95.9 inches (243.5 cm)	67.8 inches (172.3 cm)	42.4 inches (107.7 cm)	10.0 inches (25.4 cm)	13.0 inches (33.0 cm)
85 inches	99.3 inches (252.3 cm)	72.1 inches (183.1 cm)	45.0 inches (114.4 cm)	11.4 inches (28.9 cm)	13.8 inches (35.0 cm)

Diagonal image size	Min. ceiling height	Image width	Image height	Min. projection distance	Distance from top of image to wall plate
88 inches	101.4 inches (257.6 cm)	74.6 inches (189.5 cm)	46.6 inches (118.5 cm)	12.2 inches (31.1 cm)	14.2 inches (36.2 cm)

BrightLink 475Wi/485Wi

16:10 Aspect Ratio

Diagonal image size	Min. ceiling height	Image width	Image height	Min. projection distance	Distance from top of image to wall plate
60 inches	78.7 inches (199.8 cm)	50.9 inches (129.2 cm)	31.8 inches (80.8 cm)	2.5 inches (6.2 cm)	6.9 inches (17.4 cm)
70 inches	85.0 inches (215.9 cm)	59.4 inches (150.8 cm)	37.1 inches (94.2 cm)	4.9 inches (12.4 cm)	7.9 inches (20.1 cm)
80 inches	91.4 inches (232.0 cm)	67.8 inches (172.3 cm)	42.4 inches (107.7 cm)	7.3 inches (18.7 cm)	9.0 inches (22.7 cm)
88 inches	96.4 inches (245.0 cm)	74.6 inches (189.5 cm)	46.6 inches (118.5 cm)	9.3 inches (23.6 cm)	9.8 inches (24.9 cm)
90 inches	97.7 inches (248.2 cm)	76.3 inches (193.9 cm)	47.7 inches (121.2 cm)	9.8 inches (24.9 cm)	10.0 inches (25.4 cm)
100 inches	104.1 inches (264.3 cm)	84.8 inches (215.4 cm)	53.0 inches (134.6 cm)	12.2 inches (31.1 cm)	11.1 inches (28.1 cm)

16:9 Aspect Ratio

Diagonal image size	Min. ceiling height	Image width	Image height	Min. projection distance	Distance from top of image to wall plate
59 inches	77.5 inches (196.8 cm)	51.5 inches (130.6 cm)	28.9 inches (73.5 cm)	2.6 inches (6.6 cm)	8.5 inches (21.7 cm)
60 inches	78.1 inches (198.3 cm)	52.3 inches (132.8 cm)	29.4 inches (74.7 cm)	2.9 inches (7.3 cm)	8.7 inches (22.0 cm)

Diagonal image size	Min. ceiling height	Image width	Image height	Min. projection distance	Distance from top of image to wall plate
70 inches	84.3 inches (214.2 cm)	61.0 inches (155.0 cm)	34.3 inches (87.2 cm)	5.4 inches (13.7 cm)	10.0 inches (25.4 cm)
77 inches	88.7 inches (225.3 cm)	67.1 inches (170.5 cm)	37.8 inches (95.9 cm)	7.1 inches (18.1 cm)	11.0 inches (27.8 cm)
80 inches	90.6 inches (230.1 cm)	69.7 inches (177.1 cm)	39.2 inches (99.6 cm)	7.9 inches (20.0 cm)	11.4 inches (28.9 cm)
90 inches	96.8 inches (246.0 cm)	78.4 inches (199.2 cm)	44.1 inches (112.1 cm)	10.4 inches (26.4 cm)	12.7 inches (32.3 cm)
97 inches	101.2 inches (257.1 cm)	84.5 inches (214.7 cm)	47.6 inches (120.8 cm)	12.2 inches (30.9 cm)	13.7 inches (34.7 cm)

4:3 Aspect Ratio

Diagonal image size	Min. ceiling height	Image width	Image height	Min. projection distance	Distance from top of image to wall plate
53 inches	78.7 inches (199.8 cm)	42.4 inches (107.7 cm)	31.8 inches (80.8 cm)	2.5 inches (6.2 cm)	6.9 inches (17.4 cm)
60 inches	83.7 inches (212.5 cm)	48 inches (121.9 cm)	36 inches (91.4 cm)	4.4 inches (11.2 cm)	7.7 inches (19.5 cm)
70 inches	90.9 inches (230.8 cm)	56.0 inches (142.2 cm)	42 inches (106.7 cm)	7.2 inches (18.2 cm)	8.9 inches (22.5 cm)
77 inches	95.9 inches (243.6 cm)	61.6 inches (156.5 cm)	46.2 inches (117.3 cm)	9.1 inches (23.1 cm)	9.7 inches (24.7 cm)
80 inches	98.1 inches (249.1 cm)	64 inches (162.6 cm)	48 inches (121.9 cm)	9.9 inches (25.2 cm)	10.1 inches (25.6 cm)
88 inches	103.8 inches (263.7 cm)	70.4 inches (182.9 cm)	52.8 inches (134.1 cm)	12.1 inches (30.8 cm)	11.0 inches (28.0 cm)

Parent topic: [Projector Placement](#)

Installing the Projector Feet

To use the projector on a table or cart, you first need to install the feet. You can then use the feet to adjust the image position.

1. Turn the projector upside down.
2. Insert the front foot into the hole at the front of the projector.

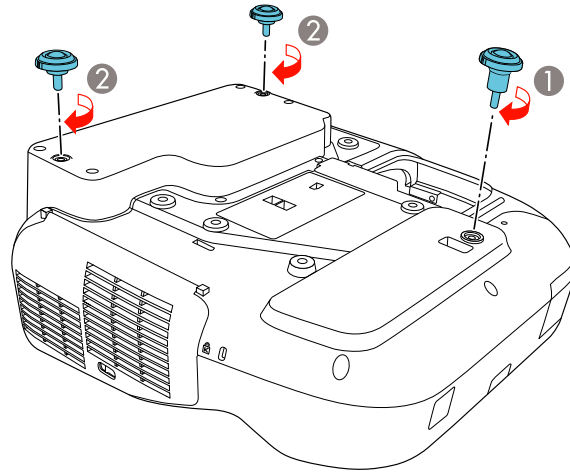

- 1 Front foot
- 2 Rear feet

3. Insert the two rear feet into the holes at the back of the projector.

Parent topic: [Setting Up the Projector](#)

Removing and Attaching the Cable Cover

Before you can connect equipment to your projector, you need to remove the cable cover.

1. Remove both of the cable cover screws (screwdriver not included).

2. Slide off the cable cover.

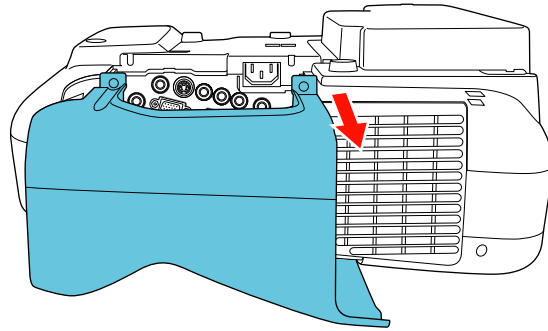
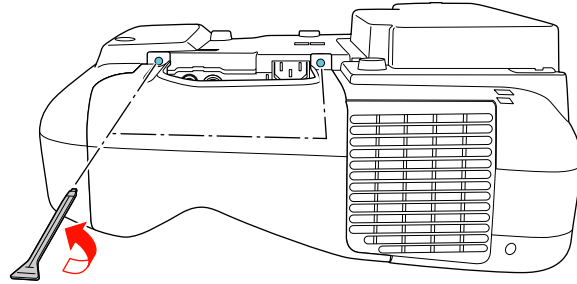

To attach the cable cover, slide it into position, then tighten the screws.

Parent topic: [Setting Up the Projector](#)

Projector Connections

You can connect the projector to a variety of computer, video, and audio sources to display presentations, movies, or other images, with or without sound.

- Connect any type of computer that has a USB port, standard video output (monitor) port, or HDMI port.
- For video projection, connect devices such as DVD players, gaming consoles, digital cameras, and camera phones with compatible video output ports.
- If your presentation or video includes sound, you can connect audio input cables, if necessary.

- For slide shows without a computer, you can connect USB devices (such as a flash drive or camera) or an optional EPSON document camera.

Caution: If you will use the projector at altitudes above 4921 feet (1500 m), turn on **High Altitude Mode** to ensure the projector's internal temperature is regulated properly.

[Connecting to Computer Sources](#)

[Connecting to Video Sources](#)

[Connecting to an External Computer Monitor](#)

[Connecting to External Speakers](#)

[Connecting a Microphone](#)

[Connecting to External USB Devices](#)

[Connecting to a Document Camera](#)

Parent topic: [Setting Up the Projector](#)

Related references

[Projector Setup Settings - Extended Menu](#)

[Product Box Contents](#)

Connecting to Computer Sources

Follow the instructions in these sections to connect a computer to the projector.

[Connecting to a Computer for USB Video and Audio](#)

[Connecting to a Computer for VGA Video](#)

[Connecting to a Computer for HDMI Video and Audio](#)

[Connecting to a Computer for Pen Use or USB Mouse Control](#)

[Connecting to a Computer for Sound](#)

Parent topic: [Projector Connections](#)

Connecting to a Computer for USB Video and Audio

If your computer meets the system requirements, you can send video and audio output to the projector through the computer's USB port (preferably USB 2.0). Connect the projector to your computer using a USB cable.

Note: This also lets you use the interactive pens with your computer. You need to adjust the **USB Type B** setting in the projector's Extended menu before you can project through the USB port. Note that using

USB Display will slow interactive pen function. For the best performance, VGA or HDMI connections are recommended.

1. Turn on your computer.
2. Connect the cable to your projector's **USB-B** port.

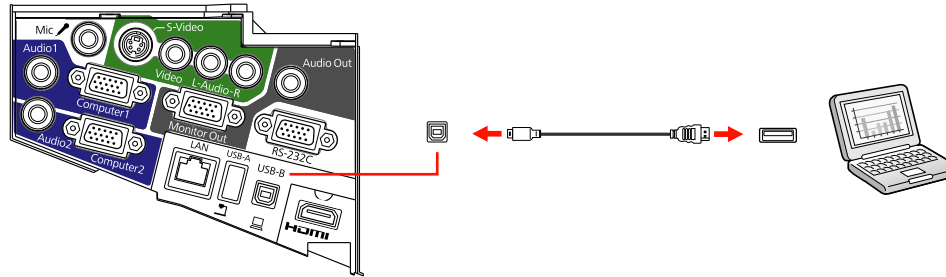

3. Connect the other end to any available USB port on your computer.
4. Do one of the following:
 - **Windows 7/Windows Vista:** Select **Run EMP_UDSE.exe** in the dialog box that appears to install the EPSON USB Display software.
 - **Windows XP:** Wait as messages appear on your computer screen and the projector installs the EPSON USB Display software on your computer.
 - **Windows 2000:** Select **Computer**, **EPSON_PJ_UD**, and **EMP_UDSE.EXE** to install the EPSON USB Display software.
 - **Mac OS X:** The USB Display setup folder appears on your screen. Select **USB Display Installer** and follow the on-screen instructions to install the EPSON USB Display software.

Follow any on-screen instructions. You need to install this software only the first time you connect the projector to the computer.

The projector displays the image from your computer's desktop and outputs sound, if your presentation contains audio.

Parent topic: [Connecting to Computer Sources](#)

Related references

[Projector Setup Settings - Extended Menu](#)

Connecting to a Computer for VGA Video

You can connect the projector to your computer using a VGA computer cable.

Note: To connect a Mac that includes only a Mini DisplayPort or Mini-DVI port for video output, you need to obtain an adapter that allows you to connect to the projector's VGA video port. Contact Apple for compatible adapter options.

1. If necessary, disconnect your computer's monitor cable.
2. Connect the VGA computer cable to your computer's monitor port.
3. Connect the other end to a **Computer** port on the projector.

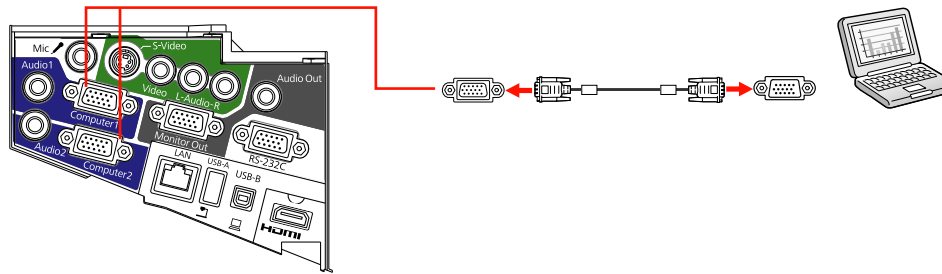

4. Tighten the screws on the VGA connectors.

Parent topic: [Connecting to Computer Sources](#)

Connecting to a Computer for HDMI Video and Audio

If your computer has an HDMI port, you can connect it to the projector using an optional HDMI cable.

Note: To connect a Mac that includes only a Mini DisplayPort or Mini-DVI port for video output, you need to obtain an adapter that allows you to connect to the projector's **HDMI** port. Contact Apple for compatible adapter options. Older Mac computers (2009 and earlier) may not support audio through the **HDMI** port.

1. Connect the HDMI cable to your computer's HDMI output port.

2. Connect the other end to the projector's **HDMI** port.

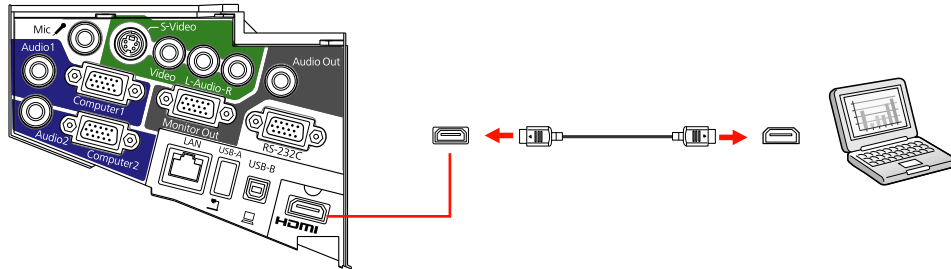

Parent topic: [Connecting to Computer Sources](#)

Connecting to a Computer for Pen Use or USB Mouse Control

If you connected your computer to a **Computer** or **HDMI** port on the projector, you also need to connect the USB cable so you can use the pens with your computer.

Connecting the USB cable also lets you set up the remote control to act as a wireless mouse, but you cannot use this feature at the same time you are using the pens with your computer.

1. Connect the USB cable to your projector's **USB-B** port.

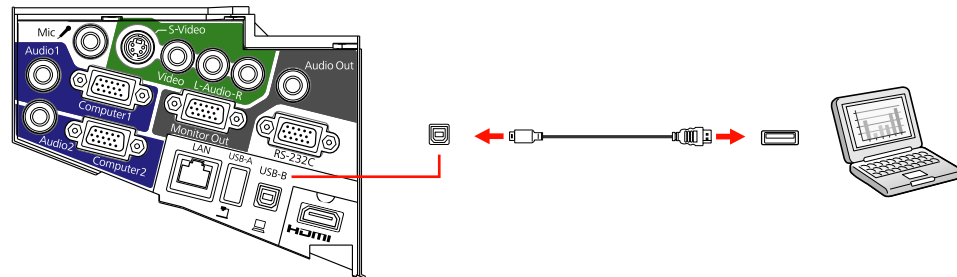

2. Connect the other end to any available USB port on your computer.

If you want to use the remote control as a wireless mouse, you need to change the **USB Type B** setting in the projector's Extended menu. You may also need to configure your computer to work with an external USB mouse. See your computer documentation for details.

Parent topic: [Connecting to Computer Sources](#)

Related references

[Projector Setup Settings - Extended Menu](#)

[Projector Parts - Remote Control](#)

Connecting to a Computer for Sound

If your computer presentation includes sound and you did not connect it to the projector's **USB-B** or **HDMI** port, you can still play sound through the projector's speaker system. Just connect an optional 3.5 mm stereo mini-jack audio cable as described here.

1. Connect the audio cable to your laptop's headphone or audio-out jack, or your desktop's speaker or audio-out port.
2. Connect the other end to the **Audio** port that corresponds to the **Computer** port you are using.

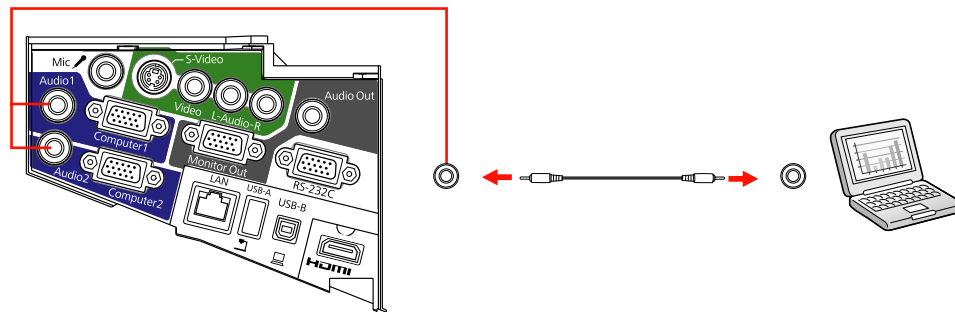

Parent topic: [Connecting to Computer Sources](#)

Connecting to Video Sources

Follow the instructions in these sections to connect video devices to the projector.

[Connecting to an HDMI Video Source](#)

[Connecting to a Component-to-VGA Video Source](#)

[Connecting to a Composite Video Source](#)

[Connecting to an S-Video Video Source](#)

[Connecting to a Video Source for Sound](#)

Parent topic: [Projector Connections](#)

Connecting to an HDMI Video Source

If your video source has an HDMI port, you can connect it to the projector using an optional HDMI cable. The HDMI connection provides the best image quality.

1. Connect the HDMI cable to your video source's HDMI output port.
2. Connect the other end to the projector's **HDMI** port.

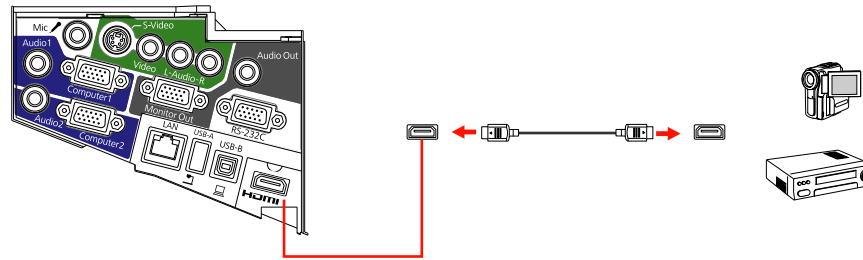

Parent topic: [Connecting to Video Sources](#)

Connecting to a Component-to-VGA Video Source

If your video source has component video ports, you can connect it to the projector using a component-to-VGA video cable. Depending on your component ports, you may need to use an adapter cable along with a component video cable.

1. Connect the component connectors to your video source's color-coded component video output ports, usually labeled **Y**, **Pb**, **Pr** or **Y**, **Cb**, **Cr**. If you are using an adapter, connect these connectors to your component video cable.
2. Connect the VGA connector to the projector's **Computer** port.

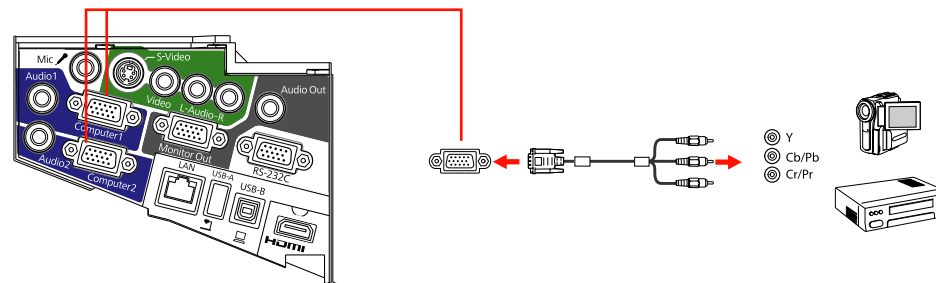

If your image colors appear incorrect, you may need to change the **Input Signal** setting in the projector's Signal menu.

Parent topic: [Connecting to Video Sources](#)

Related references

[Input Signal Settings - Signal Menu](#)

Connecting to a Composite Video Source

If your video source has a composite video port, you can connect it to the projector using an optional RCA-style video or A/V cable.

1. Connect the cable with the yellow connector to your video source's yellow video output port.
2. Connect the other end to the projector's **Video** port.

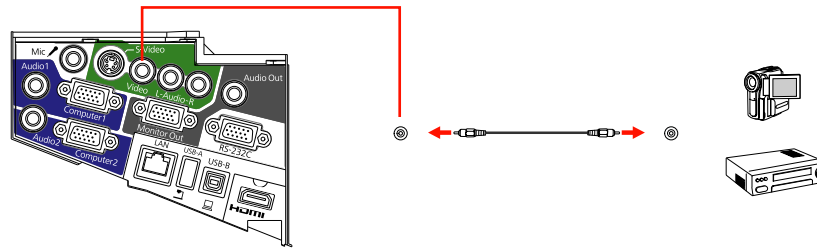

Parent topic: [Connecting to Video Sources](#)

Connecting to an S-Video Video Source

If your video source has an S-Video port, you can connect it to the projector using an optional S-Video cable.

1. Connect the S-Video cable to your video source's S-Video output port.

2. Connect the other end to the projector's **S-Video** port.

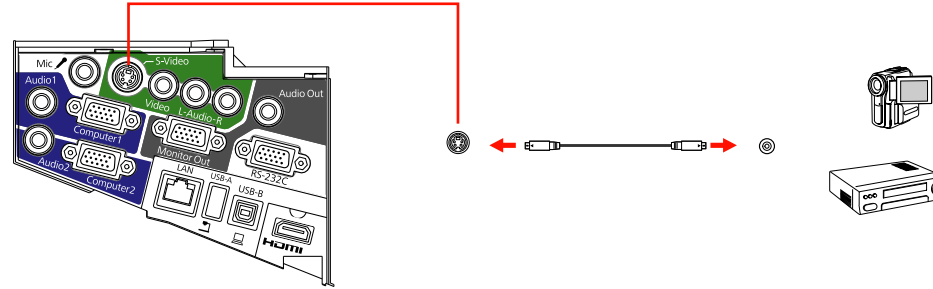

Parent topic: [Connecting to Video Sources](#)

Connecting to a Video Source for Sound

You can play sound through the projector's speaker system if your video source has audio output ports.

If you are projecting video using a **Computer** port, connect the projector to the video source using an optional stereo mini-jack audio cable or an RCA audio cable.

If you are projecting video using the **Video** or **S-Video** port, connect the projector to the video source using an RCA audio cable.

1. Connect the audio cable to your video source's audio-out ports.
2. Do one of the following:
 - Connect the other end of the cable to the projector's **Audio** port that corresponds to the **Computer** port you are using for video.
 - Connect the red and white plugs on the other end of the cable to the projector's **L-Audio-R** ports.

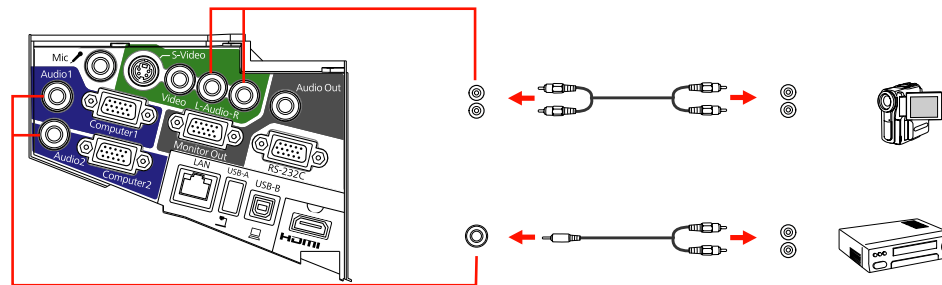

Parent topic: [Connecting to Video Sources](#)

Connecting to an External Computer Monitor

If you connected the projector to a computer using a **Computer** port, you can also connect an external monitor to the projector. This lets you see your presentation on the external monitor even when the projected image is not visible.

Note: Monitors that use a refresh rate less than 60 MHz may not be able to display images correctly.

1. Make sure your computer is connected to the projector's **Computer** port. If there are two computer ports, make sure you use the **Computer1** port.
2. Connect the external monitor's cable to your projector's **Monitor Out** port.

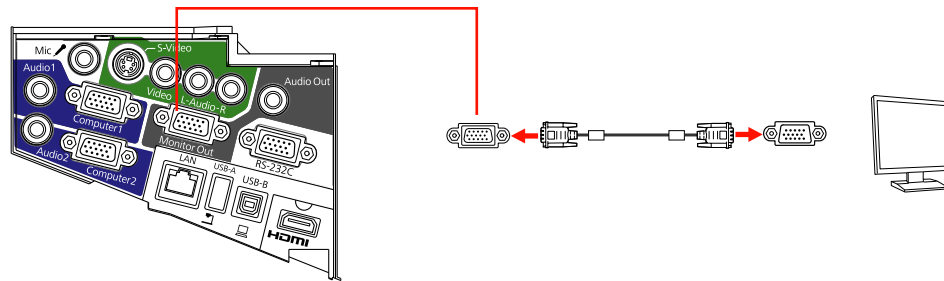

Parent topic: [Projector Connections](#)

Connecting to External Speakers

To enhance the sound from your presentation, you can connect the projector to external speakers with built-in amplifiers. You can control the volume using the projector's remote control.

If you want to output audio from the external speakers when the projector is turned off, you need to adjust the **Standby Setup** settings in the projector's Extended menu.

Note: The projector's built-in speaker system is disabled when you connect external speakers.

1. Make sure your computer or video source is connected to the projector with both audio and video cables as necessary.

2. Locate the appropriate cable to connect your external speakers, such as a stereo mini-jack-to-pin-jack cable, or another type of cable or adapter.
3. Connect one end of the cable to your external speakers as necessary.
4. Connect the stereo mini-jack end of the cable to your projector's **Audio Out** port.

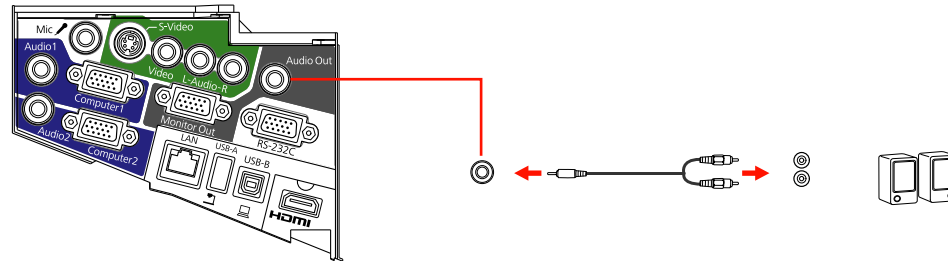

Parent topic: [Projector Connections](#)

Connecting a Microphone

You can connect a microphone to the projector's **Mic** port to provide audio support during presentations.

Note: If you want to output audio from the microphone when the projector is turned off, you need to adjust the **Standby Setup** settings in the Extended menu.

1. Connect the microphone cable to the projector's **Mic** port.

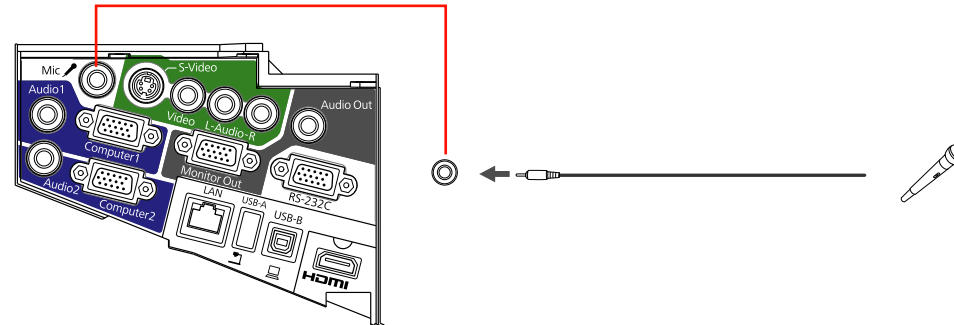

2. Turn on the microphone, if necessary.

Parent topic: [Projector Connections](#)

Connecting to External USB Devices

Follow the instructions in these sections to connect external USB devices to the projector.

[USB Device Projection](#)

[Connecting a USB Device or Camera to the Projector](#)

[Selecting the Connected USB Source](#)

[Disconnecting a USB Device or Camera From the Projector](#)

Parent topic: [Projector Connections](#)

USB Device Projection

You can project images and other content without using a computer or video device by connecting any of these devices to your projector:

- USB flash drive
- Digital camera or camera phone
- USB hard drive
- Multimedia storage viewer
- USB memory card reader

Note: Digital cameras or camera phones must be USB-mounted devices, not TWAIN-compliant devices.

Parent topic: [Connecting to External USB Devices](#)

Related topics

[Projecting a Slide Show](#)

Connecting a USB Device or Camera to the Projector

You can connect your USB device or camera to the projector's **USB-A** port and use it to project images and other content.

1. If your USB device came with a power adapter, plug the device into an electrical outlet.

2. Connect the USB cable (or USB flash drive or USB memory card reader) into the projector's **USB-A** port shown here.

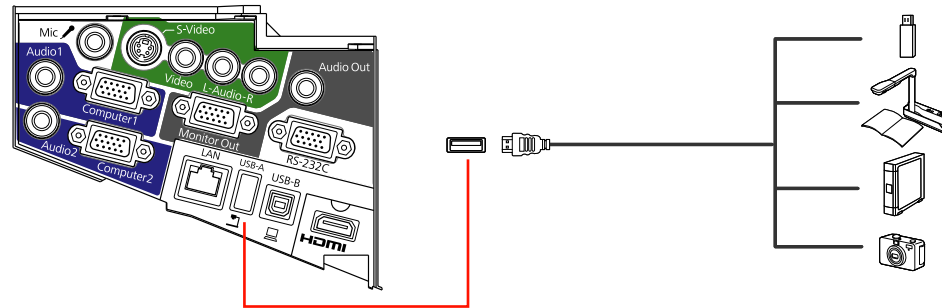

Note: Do not connect a USB hub or a USB cable longer than 10 feet (3 m), or the device may not operate correctly.

3. Connect the other end of the cable (if applicable) to your device.

Parent topic: [Connecting to External USB Devices](#)

Related topics

[Projecting a Slide Show](#)

Selecting the Connected USB Source

You can switch the projector's display to the source you connected to a **USB-A** port.

1. Make sure the connected USB source is turned on, if necessary.
2. Press the **USB** button on the remote control.
3. Press the button again to cycle through other USB sources, if available.

Parent topic: [Connecting to External USB Devices](#)

Disconnecting a USB Device or Camera From the Projector

When you finish presenting with a connected USB device or camera, you must prepare to disconnect the device from the projector.

1. If the device has a power button, turn off and unplug the device.
2. Disconnect the USB device or camera from the projector.

Parent topic: [Connecting to External USB Devices](#)

Connecting to a Document Camera

You can connect the EPSON DC-06 document camera to your projector's **USB-A** port to project images viewed by the camera.

Note: For additional features supported by software, connect the EPSON DC-06 document camera to your computer instead of the projector. You may be able to connect different EPSON document camera models to your projector's **Computer** port. See the document camera's manual for instructions.

1. Locate the USB cable that came with the document camera.
2. Connect the USB cable to the projector's **USB-A** port.

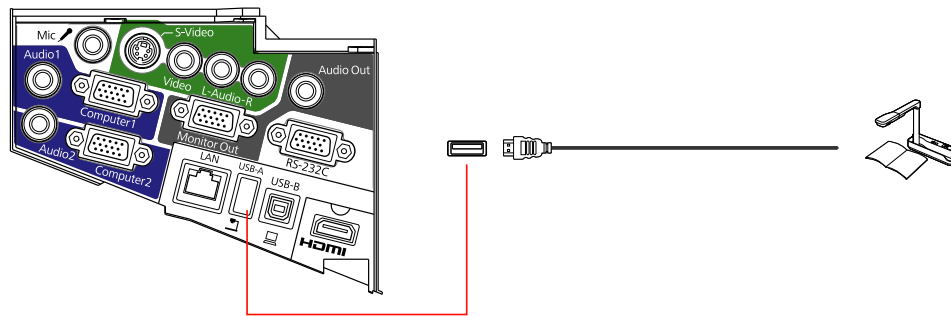

3. Connect the other end of the cable to the document camera's USB Type B port.

Parent topic: [Projector Connections](#)

Related references

[Optional Equipment and Replacement Parts](#)

Installing Batteries in the Remote Control

The remote control uses the two AA batteries that came with the projector.

Caution: Use only the type of batteries specified in this manual. Do not install batteries of different types, or mix new and old batteries.

1. Open the battery cover as shown.

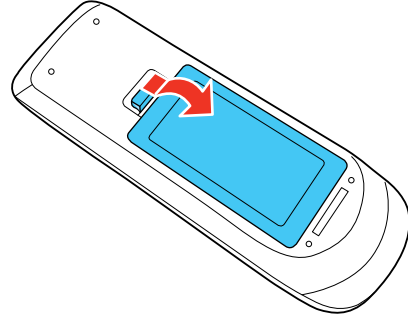

2. Insert the batteries with the + and – ends facing as shown.

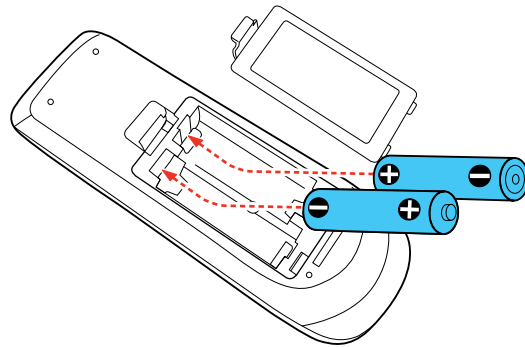

3. Close the battery cover and press it down until it clicks into place.

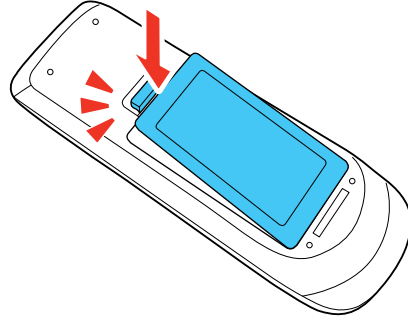

Warning: Dispose of used batteries according to local regulations. Do not expose batteries to heat or flame. Keep batteries out of the reach of children; they are choking hazards and are very dangerous if swallowed.

Parent topic: [Setting Up the Projector](#)

Installing Batteries in the Pens

Each pen uses one AA battery.

1. Open the battery cover as shown.

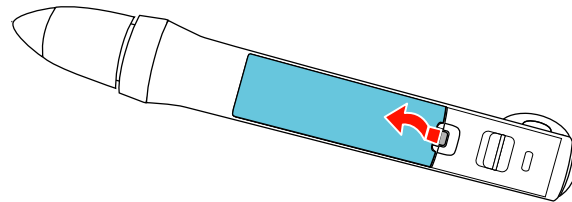

2. Insert the battery with the + and – ends facing as shown.

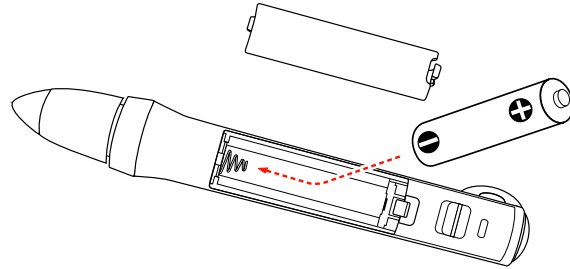

3. Replace the battery cover and press it down until it clicks into place.

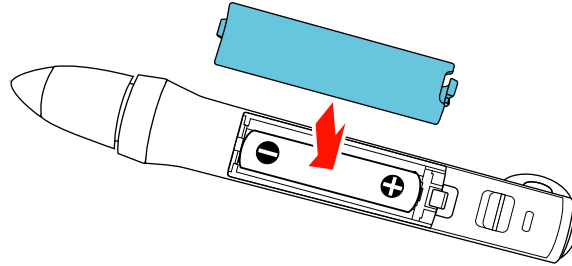

Parent topic: [Setting Up the Projector](#)

Using the Projector on a Network

Follow the instructions in these sections to set up your projector for use on a network.

Note: To use the interactive pens with your projected computer image, you need to connect the USB cable, even if you are projecting through the network.

[Wired Network Projection](#)

[Wireless Network Projection](#)

[Setting Up Projector Network E-Mail Alerts](#)

[Setting Up Monitoring Using SNMP](#)

[Controlling a Networked Projector Using a Web Browser](#)

[Crestron RoomView Support](#)

Wired Network Projection

You can send images to your projector through a wired network. To do this, you connect the projector to your network, and then set up your projector and computer for network projection.

After connecting and setting up the projector as described here, install the network software from the *Epson Projector Software* CD-ROM on your computer. Use the following software and documentation to set up, control, and monitor network projection:

- **EasyMP Network Projection** software sets up your computer for network projection. See the *EasyMP Network Projection Operation Guide* installed from your projector CD for instructions.
- **EasyMP Monitor** software (Windows only) lets you monitor and control your projector through the network. You can download the latest software and documentation from the Epson web site. Go to www.epson.com/support (U.S.) or www.epson.ca/support (Canada) and select your projector.

Note: If your projector is connected via a LAN cable to a network that includes a wireless access point, you can connect to the projector wirelessly using the EasyMP Network Projection software.

[Connecting to a Wired Network](#)

[Selecting Wired Network Settings](#)

Parent topic: [Using the Projector on a Network](#)

Connecting to a Wired Network

To connect the projector to a wired local area network (LAN), use a 100Base-TX or 10Base-T network cable. To ensure proper data transmission, use a Category 5 shielded cable or better.

1. Connect one end of the network cable to your network hub, switch, or router.
2. Connect the other end of the cable to the projector's **LAN** port.

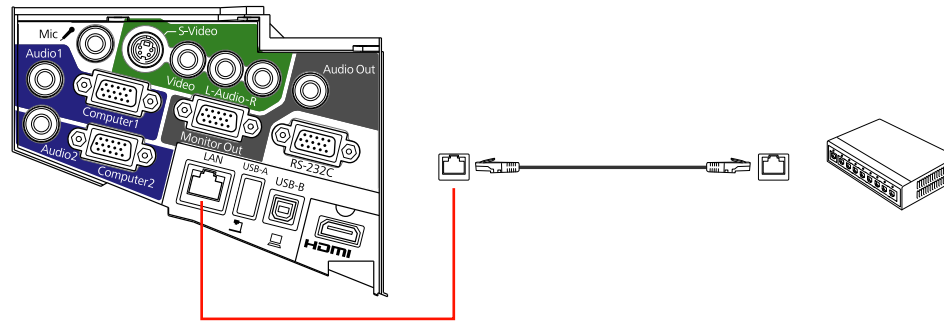

Parent topic: [Wired Network Projection](#)

Selecting Wired Network Settings

Before you can project from computers on your network, you must select the network settings for the projector using its menu system.

Note: Make sure you already connected the projector to your wired network using the **LAN** port.

1. Turn on the projector.
2. Press the **Menu** button.

3. Select the **Network** menu and press **Enter**.

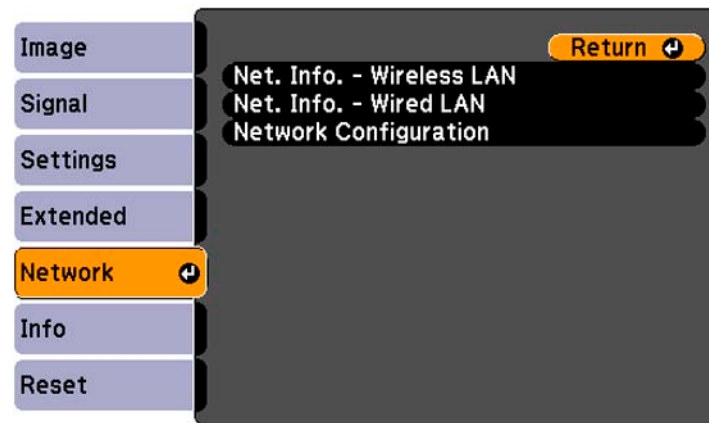

4. Select **Network Configuration** and press **Enter**.
5. Select the **Basic** menu and press **Enter**.

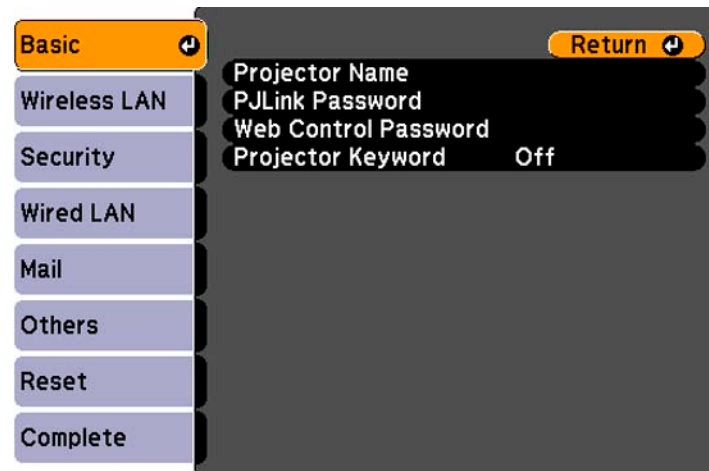

6. Select the following basic options as necessary:
 - **Projector Name** lets you enter a name up to 16 alphanumeric characters long to identify the projector over the network.

- **PJLink Password** lets you enter a password up to 32 alphanumeric characters long for using the PJLink protocol for projector control.
- **Web Control Password** lets you enter a password up to 8 alphanumeric characters long for accessing the projector over the web.
- **Projector Keyword** lets you turn on a security password to prevent access to the projector by anyone not in the room with it. You must enter a displayed, randomized keyword from a computer using the EasyMP Network Projection software to access the projector.

Note: Use the displayed keyboard to enter the name, passwords and keyword. Press the arrow buttons on the remote control to highlight characters and press **Enter** to select them.

7. Select the **Wired LAN** menu and press **Enter**.

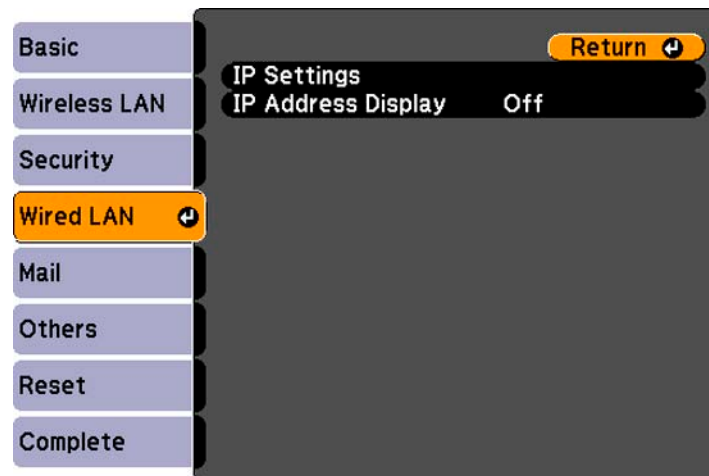

8. If necessary, select **IP Settings** and press **Enter**.
9. Select your IP Settings as necessary:
 - If your network assigns addresses automatically, turn on the **DHCP** setting.
 - If you must set addresses manually, turn off **DHCP** and enter the projector's **IP Address**, **Subnet Mask**, and **Gateway Address** as needed.

Note: To highlight the numbers you want from the displayed keyboard, press the arrow buttons on the remote control. To select a highlighted number, press **Enter**.

10. To prevent display of the IP address on the standby screen, turn off **IP Address Display**.
11. When you finish selecting settings, select **Complete** and follow the on-screen instructions to save your settings and exit the menus.

Parent topic: [Wired Network Projection](#)

Wireless Network Projection

You can send images to your projector through a wireless network. To do this, you must install the optional EPSON 802.11b/g/n wireless LAN module, and then set up your projector and computer for wireless projection.

Note: To use the interactive pens with your projected computer image, you need to connect the USB cable, even if you are projecting wirelessly through the network. Or, you can use the built-in toolbar to annotate images projected over the network.

Note: If your projector is connected via a LAN cable to a network that includes a wireless access point, you can connect to the projector wirelessly using the EasyMP Network Projection software.

There are two ways to connect the projector to your wireless network:

- Using the optional EPSON Quick Wireless Connection USB key (Windows only)
- Configuring the connection manually using the projector's **Network** menus

After installing the module and setting up the projector, install the network software from the *Epson Projector Software* CD on your computer. Use the following software and documentation to set up, control, and monitor wireless projection:

- **EasyMP Network Projection** software sets up your computer for wireless network projection. See the *EasyMP Network Projection Operation Guide* installed from your projector CD for instructions.
- **EasyMP Monitor** software (Windows only) lets you monitor and control your projector through the network. You can download the latest software and documentation from the Epson web site. Go to www.epson.com/support (U.S.) or www.epson.ca/support (Canada) and select your projector.

[Installing the Wireless LAN Module](#)

[Using Quick Wireless Connection \(Windows Only\)](#)

[Selecting Wireless Network Settings Manually](#)

[Selecting Wireless Network Settings in Windows](#)

[Selecting Wireless Network Settings in Mac OS X](#)

[Setting Up Wireless Network Security](#)

Parent topic: [Using the Projector on a Network](#)

Related references

[Optional Equipment and Replacement Parts](#)

Installing the Wireless LAN Module

To use the projector over a wireless network, install the EPSON 802.11b/g/n wireless module in the projector. Do not install any other type of wireless module.

Caution: Never remove the module while its indicator light is green or flashing, or while you are projecting wirelessly. You may damage the module or lose data.

1. Turn off the projector and unplug the power cord.
2. Unscrew and remove the cable cover if it is attached (screwdriver not included).

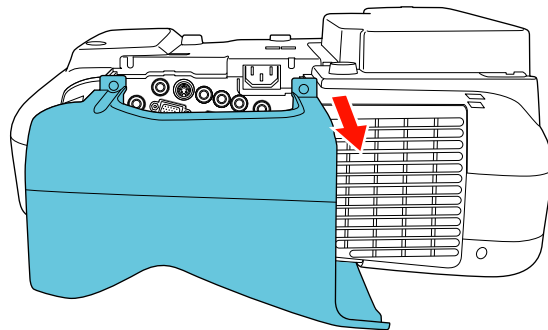
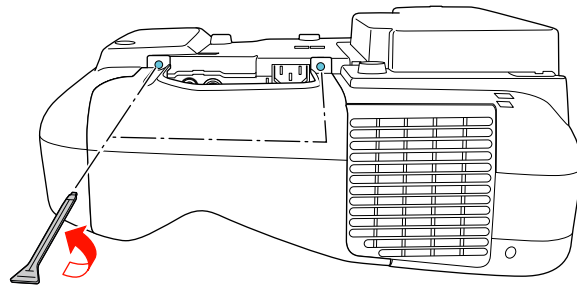

3. Insert the wireless LAN module into the port.

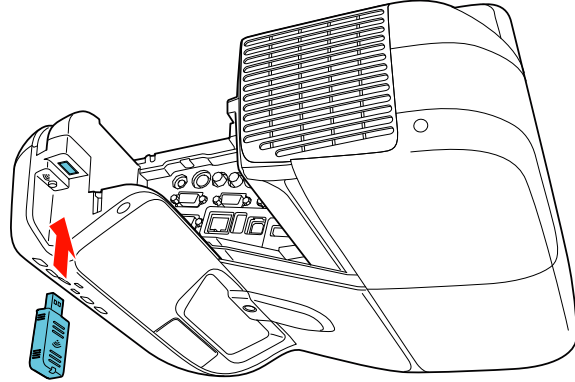

4. Replace the cable cover and tighten the screws.
5. Plug in and turn on the projector.

Parent topic: [Wireless Network Projection](#)

Related references

[Optional Equipment and Replacement Parts](#)

Using Quick Wireless Connection (Windows Only)

You can use the optional EPSON Quick Wireless Connection USB key to quickly connect the projector to a Windows computer wirelessly. Then you can project your presentation and remove the key when you are done.

1. Turn on the projector.
2. Connect the USB key to the projector's **USB-A** port.

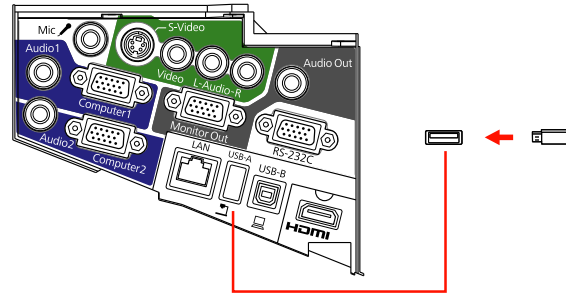

You see a projected message that the network information update is complete.

3. Remove the USB key.
4. Now connect the USB key to a USB port on your computer or notebook.

Note: In Windows Vista, if you see the AutoPlay window, select **Run LaunchU3.exe**, then select **Allow** on the next screen.

5. Follow the on-screen instructions to install the Quick Wireless Connection driver.

Note: If you see a Windows Firewall message, click **Yes** to disable the firewall.

After a few minutes, your computer image is displayed by the projector. If it does not appear, press the **LAN** button on your projector remote control or restart your computer.

6. Run your presentation as necessary.
7. When you finish projecting wirelessly, remove the USB key from your computer.

Note: You may need to restart your computer to reactivate your wireless LAN connection.

Parent topic: [Wireless Network Projection](#)

Selecting Wireless Network Settings Manually

Before you can project from your wireless network, you must select the network settings for the projector using its menu system.

1. Turn on the projector.

2. Press the **Menu** button.
3. Select the **Network** menu and press **Enter**.

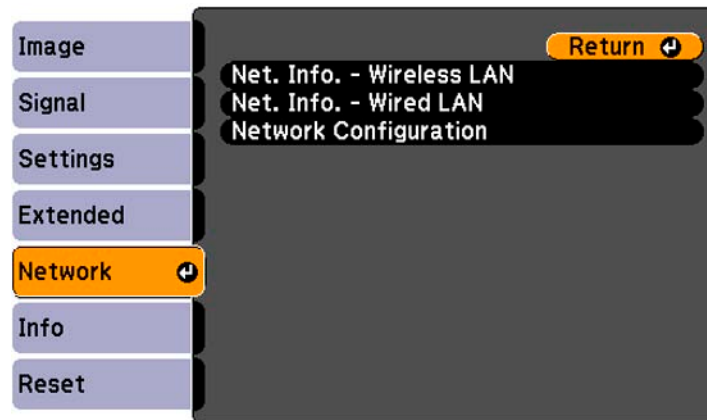

4. Select **Network Configuration** and press **Enter**.
5. Select the **Basic** menu and press **Enter**.

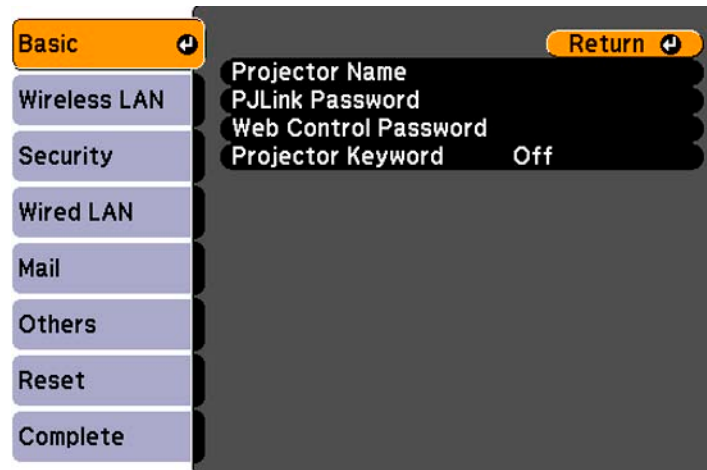

6. Select the following basic options as necessary:

- **Projector Name** lets you enter a name up to 16 alphanumeric characters long to identify the projector over the network.
- **PJLink Password** lets you enter a password up to 32 alphanumeric characters long for using the PJLink protocol for projector control.
- **Web Control Password** lets you enter a password up to 8 alphanumeric characters long for accessing the projector over the web.
- **Projector Keyword** lets you turn on a security password to prevent access to the projector by anyone not in the room with it. You must enter a displayed, randomized keyword from a computer using the EasyMP Network Projection software to access the projector.

Note: Use the displayed keyboard to enter the name, passwords and keyword. Press the arrow buttons on the remote control to highlight characters and press **Enter** to select them.

7. Select the **Wireless LAN** menu and press **Enter**.

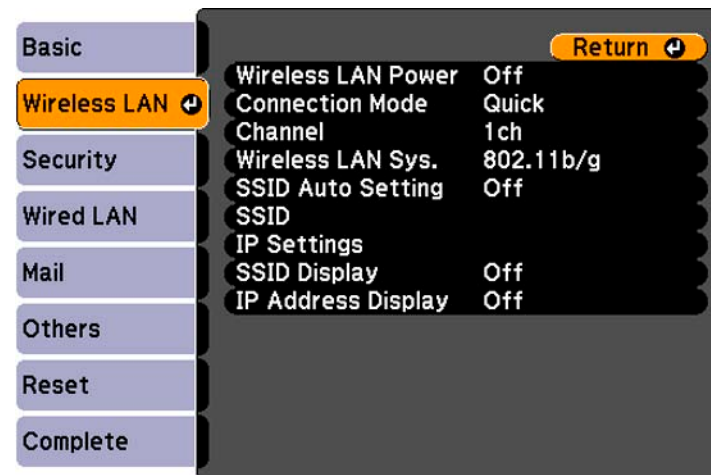

8. Select the settings on the Wireless LAN menu as necessary for your network.

9. When you finish selecting settings, select **Complete** and follow the on-screen instructions to save your settings and exit the menus.

After you complete the wireless settings for your projector, you need to select the wireless network on your computer.

Wireless LAN Menu Settings

Parent topic: [Wireless Network Projection](#)

Wireless LAN Menu Settings

Note: See your projector's *EasyMP Network Projection Operation Guide* for details on selecting these settings.

Setting	Options	Description
Wireless LAN Power	On Off	Turns on wireless LAN support
Connection Mode	Quick Advanced	Selects the type of wireless connection: Quick: lets you quickly connect to one computer or use the optional EPSON Quick Wireless Connection USB key to connect Advanced: lets you connect to multiple computers via a wireless network access point
Channel	1ch 6ch 11ch	In Quick connection mode, selects the frequency band (channel) used by the wireless LAN
Wireless LAN Sys.	802.11b/g 802.11b/g/n	Sets the type of wireless LAN system the projector is connecting to
SSID Auto Setting	On Off	Turns on automatic SSID searching in Quick connection mode; set to Off when connecting to multiple projectors at the same time
SSID	Up 32 alphanumeric characters	Sets the SSID (network name) of the wireless LAN system the projector is connecting to

Setting	Options	Description
IP Settings	DHCP (On or Off) IP Address Subnet Mask Gateway Address	Selects DHCP if your network assigns addresses automatically, or turns off DHCP so you can enter the network's IP address, subnet mask, and gateway address as needed
SSID Display	On Off	Selects whether to display the SSID on the network standby screen
IP Address Display	On Off	Selects whether to display the IP address on the network standby screen

Parent topic: [Selecting Wireless Network Settings Manually](#)

Selecting Wireless Network Settings in Windows

Before connecting to the projector, select the correct wireless network on your computer.

1. To access your wireless utility software, double-click the network icon on the Windows taskbar.
2. Do one of the following:
 - If your projector is set up on an existing network (Advanced mode), select the network name (SSID).
 - If your projector is configured for Quick mode, select the SSID you assigned to the projector.
3. Click **Connect**.

Parent topic: [Wireless Network Projection](#)

Selecting Wireless Network Settings in Mac OS X

Before connecting to the projector, select the correct wireless network in Mac OS X.

1. Click the AirPort icon on the menu bar at the top of the screen.
2. Make sure AirPort is turned on, then do one of the following:
 - If your projector is set up on an existing network (Advanced mode), select the network name (SSID).
 - If your projector is configured for Quick mode, select the SSID you assigned to the projector.

Parent topic: [Wireless Network Projection](#)

Setting Up Wireless Network Security

You can set up security for your projector to use on the wireless network. Set up one of the following security options to match the settings used on your network:

- WEP encryption
- WPA security

Note: Check with your network administrator for guidance on entering the correct information.

1. Press the **Menu** button.
2. Select the **Network** menu and press **Enter**.
3. Select **Network Configuration** and press **Enter**.
4. Select the **Security** menu and press **Enter**.

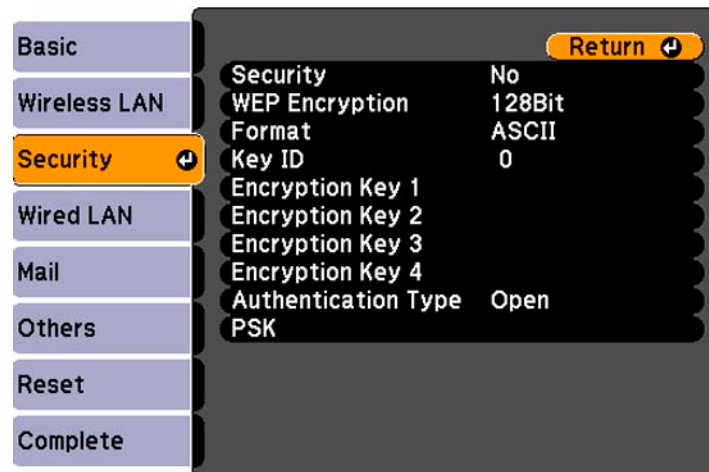

5. Select the security settings as necessary to match your network settings.
6. When you finish selecting settings, select **Complete** and follow the on-screen instructions to save your settings and exit the menus.

[Wireless Security Menu Settings](#)

Parent topic: [Wireless Network Projection](#)

Wireless Security Menu Settings

Settings on the Security menu let you select the type of security and security settings that match the network you are connecting the projector to.

Setting	Options	Description
Security	WEP and WPA types available	Selects the type of security used on the wireless network
WEP Encryption	128Bit 64Bit	For WEP security, selects the type of encryption coding
Format	ASCII HEX	For WEP security, selects the encryption input method: ASCII : enables text input HEX : enables hexadecimal input
Key ID	1 to 4	For WEP security, selects the WEP encryption key ID
Encryption Key 1 to Encryption Key 4	Various characters depending on selected WEP Encryption and Format settings	For the selected WEP Key ID setting, enter the key used for WEP encryption: 128 bit ASCII : 13 alphanumeric characters 128 bit HEX : 26 characters (0 to 9 and A to F) 64 bit ASCII : 5 alphanumeric characters 64 bit HEX : 10 characters (0 to 9 and A to F)
Authentication Type	Open Shared	For WEP security, selects the type of WEP authentication used
PSK	Various keys from 8 to 32 characters	For WPA-PSK or WPA-2-PSK security, selects the pre-shared key used on the network

Parent topic: [Setting Up Wireless Network Security](#)

Setting Up Projector Network E-Mail Alerts

You can set up the projector to send you an e-mail alert over the network if there is a problem with the projector.

1. Press the **Menu** button.
2. Select the **Network** menu and press **Enter**.
3. Select **Network Configuration** and press **Enter**.
4. Select the **Mail** menu and press **Enter**.

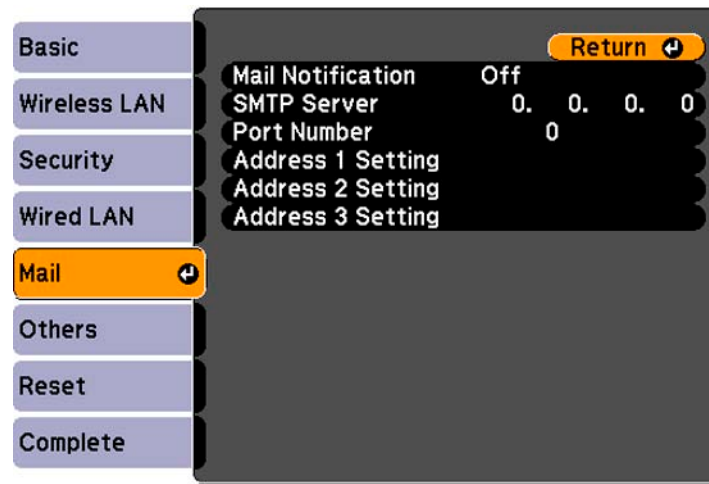

5. Turn on **Mail Notification**.
6. Enter the IP address for the **SMTP Server** option.

Note: Do not use these addresses: 127.x.x.x or 224.0.0.0 through 255.255.255.255 (where x is a number from 0 to 255).

7. Select a number for the SMTP server **Port Number**, from 1 to 65535 (default is 25).

8. Choose an **Address** field, enter the e-mail address, and select the alerts you want to receive there. Repeat for up to three addresses.

Note: Your e-mail address can be up to 32 alphanumeric characters long.

9. When you finish selecting settings, select **Complete** and follow the on-screen instructions to save your settings and exit the menu.

Note: If a critical problem causes a projector to shut down, you may not receive an e-mail alert.

[Network Projector E-mail Alert Messages](#)

Parent topic: [Using the Projector on a Network](#)

Network Projector E-mail Alert Messages

When a problem occurs with a networked projector, and you selected to receive e-mail alerts, you receive an e-mail containing the following information:

- **EPSON Projector** on the subject line
- The name of the projector experiencing a problem
- The IP address of the affected projector
- Detailed information about the problem

Note: If a critical problem causes a projector to shut down, you may not receive an e-mail alert.

Parent topic: [Setting Up Projector Network E-Mail Alerts](#)

Setting Up Monitoring Using SNMP

Network administrators can install SNMP (Simple Network Management Protocol) software on network computers so they can monitor projectors. If your network uses this software, you can set up the projector for SNMP monitoring.

1. Press the **Menu** button.
2. Select the **Network** menu and press **Enter**.
3. Select **Network Configuration** and press **Enter**.

4. Select the **Others** menu and press **Enter**.

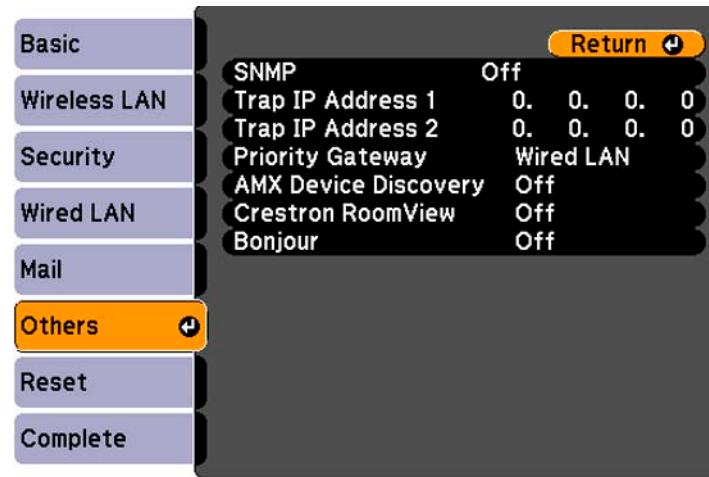

5. Enter up to two IP addresses to receive SNMP notifications, using 0 to 255 for each address field.

Note: Do not use these addresses: 127.x.x.x or 224.0.0.0 through 255.255.255.255 (where x is a number from 0 to 255).

6. If available, select the **Priority Gateway** setting for your network.
7. If your network environment uses an AMX controller, turn on the **AMX Device Discovery** setting to allow the projector to be detected.
8. If your network environment uses a Crestron RoomView controller, turn on the **Crestron RoomView** setting to allow the projector to be detected.
9. If you are connecting to a network using Bonjour, turn on the **Bonjour** setting.
10. When you finish selecting settings, select **Complete** and follow the on-screen instructions to save your settings and exit the menus.

Parent topic: [Using the Projector on a Network](#)

Controlling a Networked Projector Using a Web Browser

Once you have connected your projector to your network, you can select projector settings and control projection using a compatible web browser. This lets you access the projector remotely.

Note: If you want to use a web browser to select settings when the projector is turned off, you need to adjust the **Standby Setup** settings in the Extended menu.

1. Make sure the projector is turned on.
2. Start your web browser on a computer connected to the network.
3. Type the projector's IP address into the browser's address box and press the computer's **Enter** key.
You see the Web Control screen.
4. To select projector menu settings, select the name of the menu and follow the on-screen instructions to select settings.
5. To control projection remotely, select the **Web Remote** option.

You see this screen:

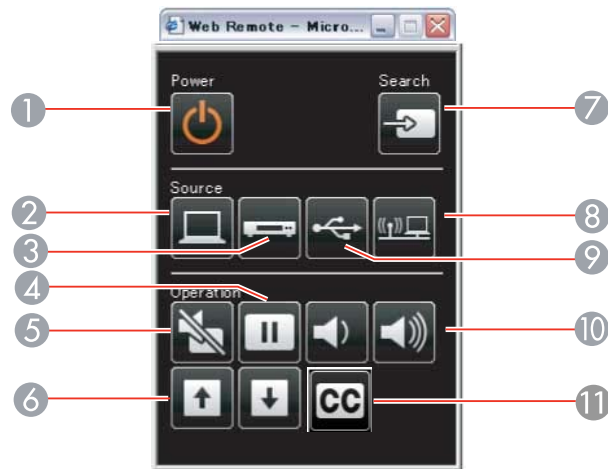

- 1 Power button control
- 2 Selects **Computer** port source
- 3 Selects **Video**, **S-Video**, and **HDMI** port sources
- 4 **Freeze** button control
- 5 **A/V Mute** button control
- 6 **Page Up** and **Page Down** button controls

- 7 Searches for sources
- 8 Selects the network source
- 9 Selects the USB Display or USB device source
- 10 **Volume** button controls
- 11 Closed Caption control

6. Select the icon corresponding to the projector function you want to control.

Parent topic: [Using the Projector on a Network](#)

Related references

[Projector Setup Settings - Extended Menu](#)

Crestron RoomView Support

If you are using the Crestron RoomView network monitoring and control system, you can set up your projector for use on the system. Crestron RoomView lets you control and monitor your projector using a web browser.

Note: You cannot use the EPSON Web Control feature or the Message Broadcasting plug-in for EasyMP Monitor when you use Crestron RoomView.

For additional information on Crestron RoomView, contact Crestron.

[Setting Up Crestron RoomView Support](#)

[Controlling a Networked Projector Using Crestron RoomView](#)

Parent topic: [Using the Projector on a Network](#)

Setting Up Crestron RoomView Support

To set up your projector for monitoring and control using a Crestron RoomView system, make sure your computer and projector are connected to the network. If you are connecting wirelessly, set up the projector using the Advanced network connection mode.

Note: If you want to use the Crestron RoomView system when the projector is turned off, you need to adjust the **Standby Setup** settings in the Extended menu.

1. Press the **Menu** button.
2. Select the **Network** menu and press **Enter**.

3. Select **Network Configuration** and press **Enter**.
4. Select the **Others** menu and press **Enter**.

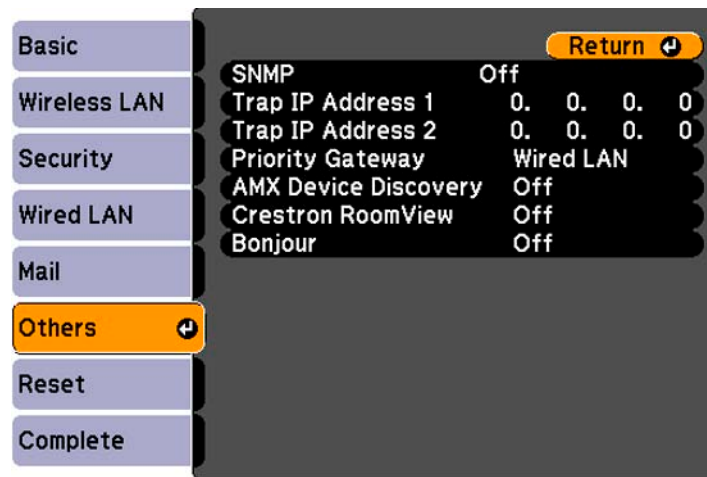

5. Set the **Crestron RoomView** setting to **On** to allow the projector to be detected.
6. When you finish selecting settings, select **Complete** and follow the on-screen instructions to save your settings and exit the menus.
7. Turn off the projector, then turn it on again to enable the setting.

Parent topic: [Crestron RoomView Support](#)

Controlling a Networked Projector Using Crestron RoomView

Once you have set up your projector to use Crestron RoomView, you can control and monitor projection using a compatible web browser.

1. Start your web browser on a computer connected to the network.
2. Type the projector's IP address into the browser's address box and press the computer's **Enter** key.

You see this screen:



3. Select the input source that you want to control in the Sources List box. You can scroll through available sources using the up and down arrows in the box.
4. To control projection remotely, click the on-screen buttons that correspond to the projector's remote control buttons. You can scroll through button options at the bottom of the screen.

Note: These on-screen buttons do not directly correspond to the projector's remote control buttons:

- **OK** acts as the **Enter** button
- **Menu** displays the **Configuration** menu

5. To view information about the projector, click the **Info** tab.
6. To change projector, Crestron, and password settings, click the **Tools** tab, select settings on the displayed screen, and click **Send**.
7. When you finish selecting settings, click **Exit** to exit the program.

Parent topic: [Crestron RoomView Support](#)

Using Basic Projector Features

Follow the instructions in these sections to use your projector's basic features.

[Turning On the Projector](#)

[Turning Off the Projector](#)

[Selecting the Language for the Projector Menus](#)

[Adjusting the Image Height](#)

[Image Shape](#)

[Resizing the Image with the Wide and Tele Buttons](#)

[Adjusting the Image Position](#)

[Focusing the Image](#)

[Remote Control Operation](#)

[Selecting an Image Source](#)

[Projection Modes](#)

[Image Aspect Ratio](#)

[Color Mode](#)

[Controlling the Volume with the Volume Buttons](#)

[Projecting a Slide Show](#)

Turning On the Projector

Turn on the computer or video equipment you want to use before you turn on the projector so it can display the image source.

1. Connect the power cord to the projector's power inlet.

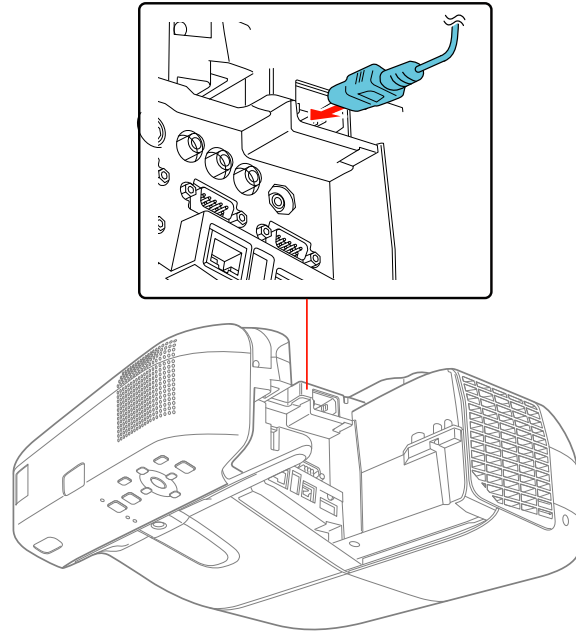

2. Plug the power cord into an electrical outlet.

The projector's power light turns orange. This indicates that the projector is receiving power, but is not yet turned on (it is in standby mode).

Note: With Direct Power On turned on, the projector turns on as soon as you plug it in.

3. Press the power button on the projector or the remote control to turn on the projector.

The projector beeps and the power light flashes green as the projector warms up. After about 30 seconds, the power light stops flashing and turns green.

Warning: Never look into the projector lens when the lamp is on. This can damage your eyes and is especially dangerous for children and pets.

If you do not see a projected image right away, try the following:

- Turn on the connected computer or video device.
- Insert a DVD or other video media, and press the play button (if necessary).
- Press the **Source Search** button on the projector or remote control to detect the video source.

Parent topic: [Using Basic Projector Features](#)

Turning Off the Projector

Before turning off the projector, shut down any computer connected to it so you can see the computer display during shutdown.

Note: Turn off this product when not in use to prolong the life of the projector. Lamp life will vary depending upon mode selected, environmental conditions, and usage. Brightness decreases over time.

1. Press the power button on the projector or the remote control.

The projector displays a shutdown confirmation screen.



2. Press the power button again. (To leave it on, press any other button.)

The projector beeps twice, the lamp turns off, and the power light turns orange.

Note: With Epson's Instant Off technology, there is no cool-down period so you can pack up the projector for transport right away (if necessary).

Caution: Do not turn the projector on immediately after turning it off. Turning the projector on and off frequently may shorten the life of the lamp.

3. To transport or store the projector, make sure the power light is orange (but not flashing), then unplug the power cord.

Caution: To avoid damaging the projector or lamp, never unplug the power cord when the power light is green or flashing orange.

Parent topic: [Using Basic Projector Features](#)

Related references

[Projector Setup Settings - Extended Menu](#)

Selecting the Language for the Projector Menus

If you want to view the projector's menus and messages in another language, you can change the Language setting.

1. Turn on the projector.
2. Press the **Menu** button.
3. Select the **Extended** menu and press **Enter**.

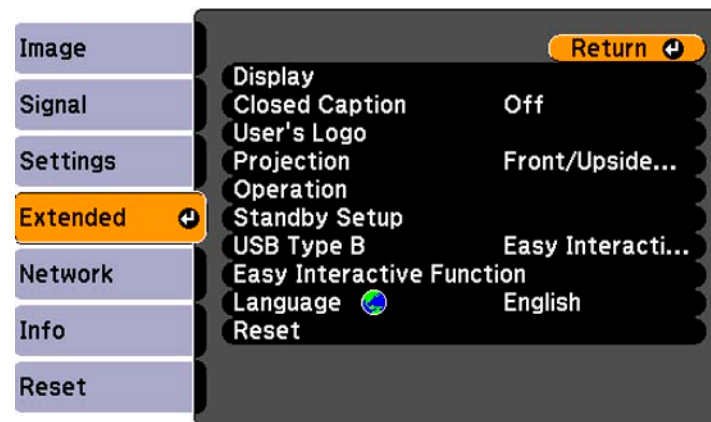

4. Select the **Language** setting and press **Enter**.
5. Select the language you want to use and press **Enter**.
6. Press **Menu** or **Esc** to exit the menus.

Parent topic: [Using Basic Projector Features](#)

Adjusting the Image Height

If you are projecting from a table or other flat surface, and the image is too high or low, you can adjust the image height using the projector's adjustable feet. Make sure the feet have been installed.

Caution: Tilting the projector will distort the image shape and may cause difficulty focusing the image. For interactive use, make sure the projector is not tilted at an angle of more than $\pm 3^\circ$ vertically or horizontally.

1. Turn on the projector and display an image.
2. To raise the image, extend the rear feet by rotating them.

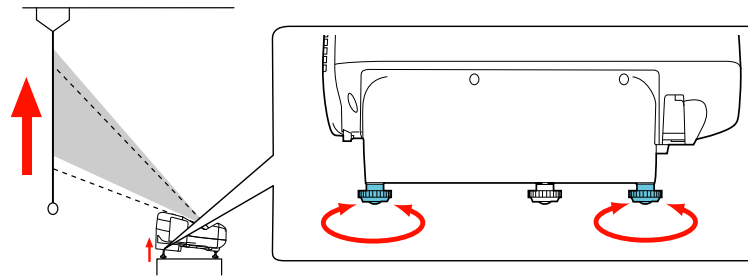

3. To lower the image, extend the front foot by rotating it.

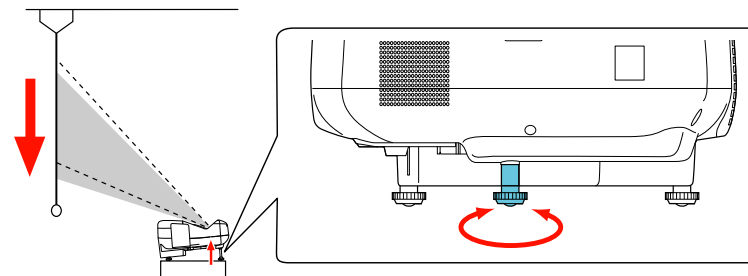

4. If the image is tilted, rotate the rear feet to adjust their height.

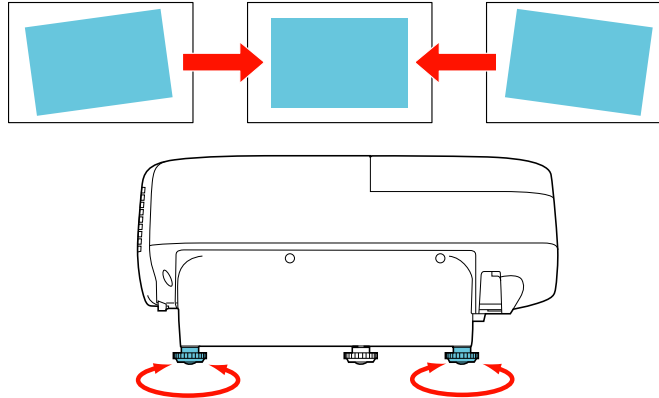

If the projected image is unevenly rectangular, you need to adjust the image shape.

Parent topic: [Using Basic Projector Features](#)

Related concepts

[Image Shape](#)

Related references

[Projector Feature Settings - Settings Menu](#)

Image Shape

You can project an evenly rectangular image by placing the projector directly in front of the center of the screen and keeping it level. If you place the projector at an angle to the screen, or tilted up or down, or off to the side, you may need to correct the image shape for the best display quality.

Note: For interactive use, the image must be evenly rectangular, without distortion.

[Correcting Image Shape with the Keystone Buttons](#)

[Correcting Image Shape with Quick Corner](#)

Parent topic: [Using Basic Projector Features](#)

Correcting Image Shape with the Keystone Buttons

You can use the projector's keystone correction buttons to correct the shape of an image that is unevenly rectangular on the sides.

Note: For interactive use, make sure the degree of horizontal and vertical keystone correction is no more than $\pm 6^\circ$.

1. Turn on the projector and display an image.

Note: You can display a pattern to aid in adjusting the projected image using the Settings menu.

2. Press one of these keystone buttons on the control panel to display the Keystone adjustment screen.

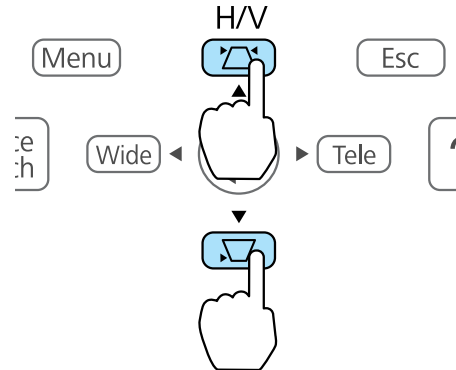

3. Press a keystone button on the projector's control panel to adjust the image shape.

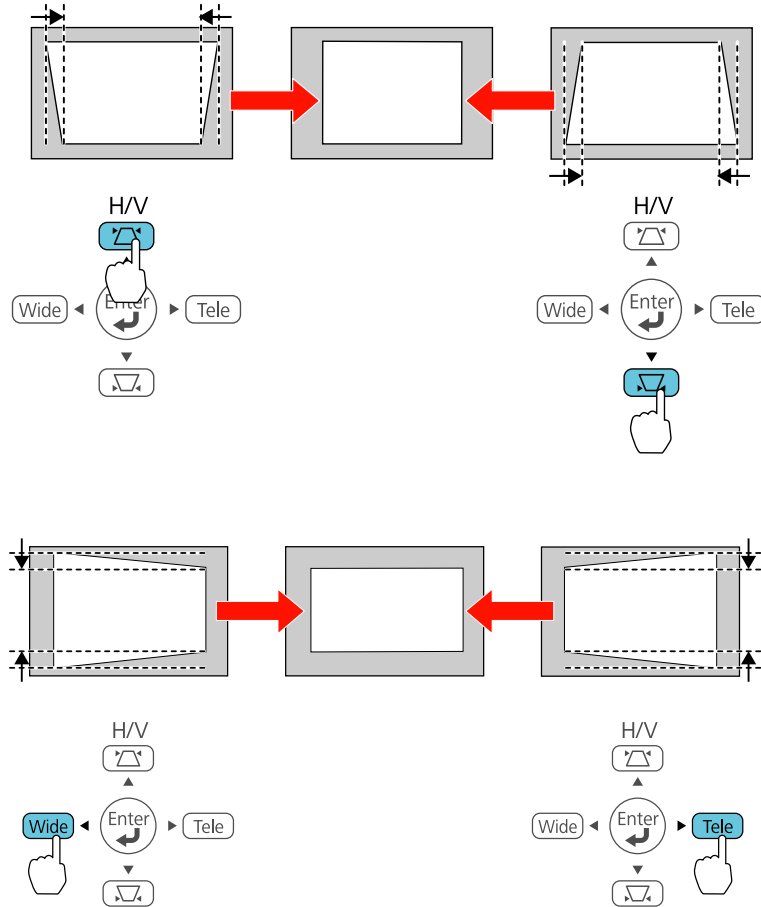

Note: The horizontal keystone adjustment buttons are labeled **Wide** and **Tele**.

After correction, your image is slightly smaller.

Note: If the projector is installed out of reach, you can also correct the image shape using the Keystone settings in the projector menus.

Parent topic: [Image Shape](#)

Related references

[Projector Feature Settings - Settings Menu](#)

Correcting Image Shape with Quick Corner

You can use the projector's Quick Corner setting to correct the shape and size of an image that is unevenly rectangular on all sides.

1. Turn on the projector and display an image.

Note: You can display a pattern to aid in adjusting the projected image using the Settings menu.

2. Press the **Menu** button.
3. Select the **Settings** menu and press **Enter**.

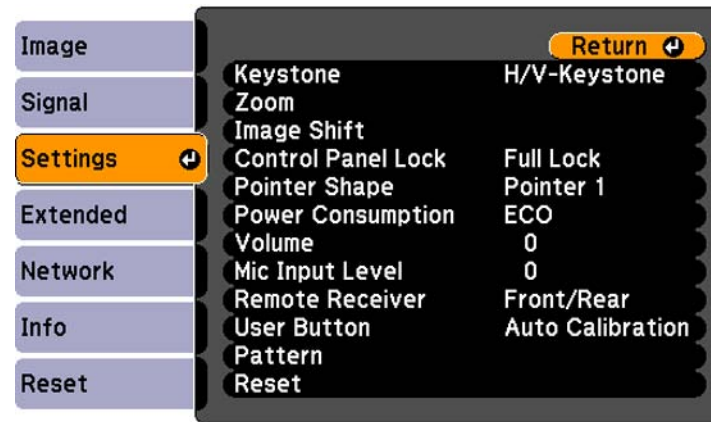

4. Select the **Keystone** setting and press **Enter**.
5. Select the **Quick Corner** setting and press **Enter**. Then press **Enter** again.
You see the Quick Corner adjustment screen.

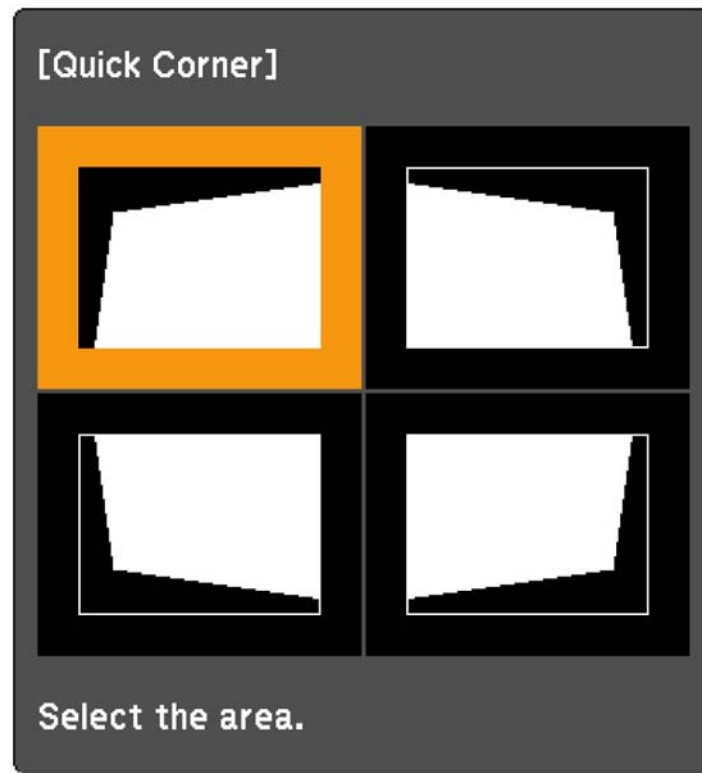

[◀ / ▶] : Select
[↵] : Enter
[Esc] : Return (press for 2 seconds to
reset/switch)

6. Use the arrow buttons on the projector or the remote control to select the corner of the image you want to adjust. Then press **Enter**.
7. Press the arrow buttons to adjust the image shape as necessary.
8. When you are finished, press **Esc**.

Parent topic: [Image Shape](#)

Resizing the Image with the Wide and Tele Buttons

1. Turn on the projector and display an image.
2. To enlarge the image size, press the **Wide** button on the projector's control panel.
3. To reduce the image size, press the **Tele** button.

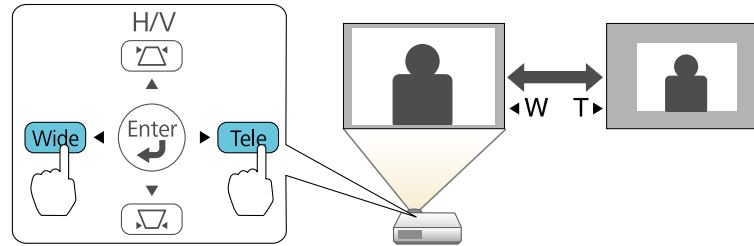

Note: If the projector is installed out of reach, you can also adjust the image size using the Zoom setting in the projector menus.

Parent topic: [Using Basic Projector Features](#)

Related references

[Projector Feature Settings - Settings Menu](#)

Adjusting the Image Position

You can use the Image Shift feature to adjust the image position without moving the projector.

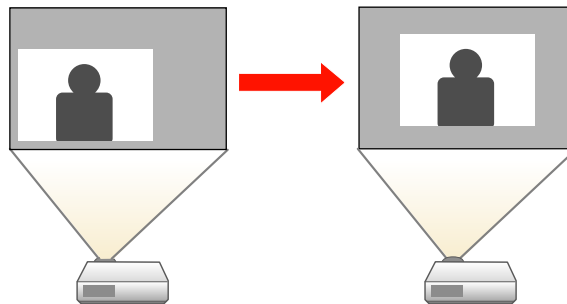

1. Turn on the projector and display an image.
2. Adjust the image size using the **Wide** and **Tele** buttons.

After you adjust the image size, the Image Shift screen is displayed automatically.

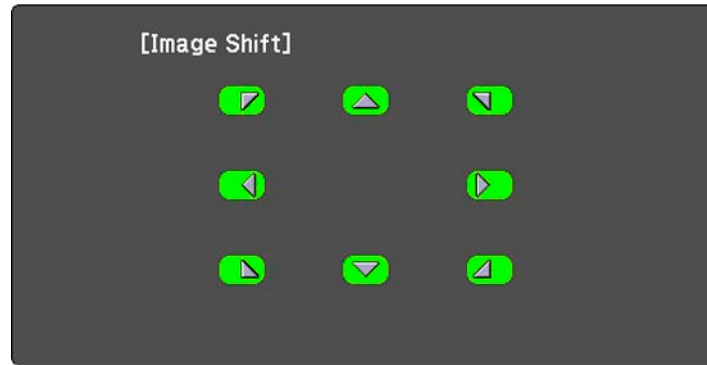

3. Use the arrow buttons on the projector or remote control to adjust the image position.

Note: You can also use the Settings menu to adjust the **Image Shift**.

Parent topic: [Using Basic Projector Features](#)

Related references

[Projector Feature Settings - Settings Menu](#)

Focusing the Image

1. Turn on the projector and display an image.

Note: You can display a pattern to aid in adjusting the projected image using the Settings menu.

2. Slide the switch to open the air filter cover on the side of the projector.
3. Raise or lower the focus lever to sharpen the image.

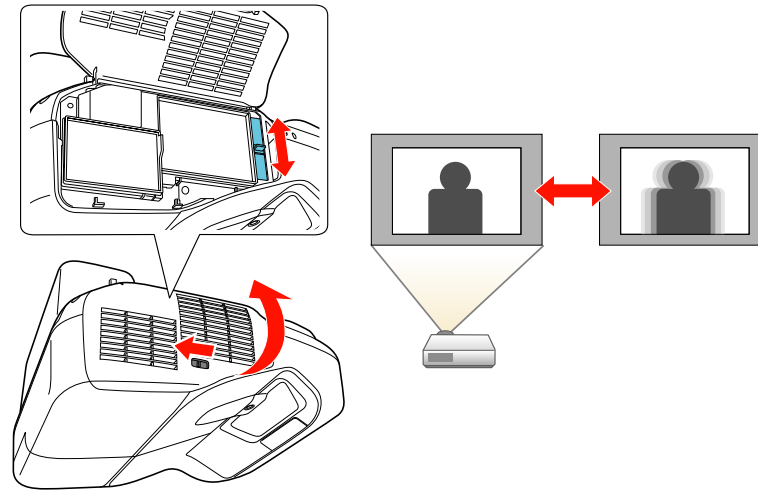

Parent topic: [Using Basic Projector Features](#)

Related references

[Projector Feature Settings - Settings Menu](#)

Remote Control Operation

The remote control lets you control the projector from almost anywhere in the room, up to 19.7 feet (6 m) away. You can point it at the screen or board, or the front or back of the projector.

Make sure that you aim the remote control at the projector's receivers within the angles listed here.

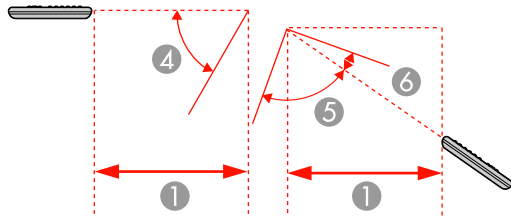
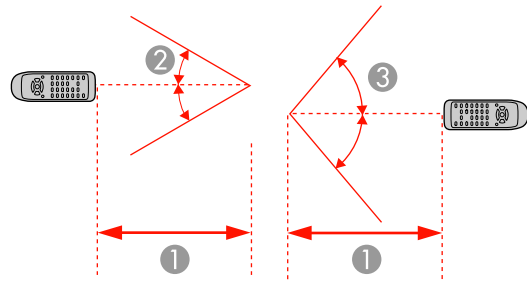

- 1 19.7 feet (6 m)
- 2 $\pm 30^\circ$
- 3 $\pm 55^\circ$
- 4 $\pm 60^\circ$
- 5 $\pm 75^\circ$
- 6 $\pm 15^\circ$

Note: Avoid using the remote control in conditions with bright fluorescent lights or in direct sunlight, or the projector may not respond to commands. If you will not use the remote control for a long time, remove the batteries.

[Using the Remote Control as a Wireless Mouse](#)

[Using the Remote Control as a Presentation Pointer](#)

Parent topic: [Using Basic Projector Features](#)

Related tasks

[Replacing the Remote Control Batteries](#)



Using the Remote Control as a Wireless Mouse

You can use the projector's remote control as a wireless mouse so you can control your computer presentation from a distance.

Note: This feature cannot be used at the same time as the interactive pens. If you want to use the remote control as a wireless mouse, you need to change the **USB Type B** setting in the projector's Extended menu.

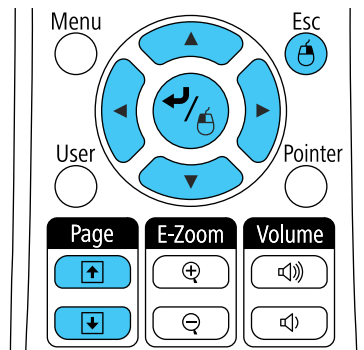
1. Connect the projector to a computer using the projector's **USB-B, Computer,** or **HDMI** port to display video.
2. If you connected your computer to the **Computer** or **HDMI** port, also connect a USB cable to the projector's **USB-B** port and to a USB port on your computer (for wireless mouse support).
3. Start your presentation.
4. Use the following buttons on the remote control to control your presentation:
 - To move through slides or pages, press the up or down **Page** buttons.



- To move the cursor on the screen, use the arrow buttons.
- To left-click, press the  button once (press it twice to double-click).
- To right-click, press the **Esc** button.
- To drag-and-drop, hold the  button as you move the cursor with the arrow buttons, then release  at the destination.

Parent topic: [Remote Control Operation](#)

Related references

[Projector Setup Settings - Extended Menu](#)

Using the Remote Control as a Presentation Pointer

You can use the projector's remote control as a pointer to help you call out important information during a presentation. The default pointer shape is an arrow, but you can select an alternative shape using the Settings menu.

1. Press the **Pointer** button on the remote control.
2. Use the arrow buttons on the remote control to move the pointer on the screen.
3. Press **Esc** to clear the pointer from the screen.

Parent topic: [Remote Control Operation](#)

Related references

[Projector Feature Settings - Settings Menu](#)

Selecting an Image Source

If you connected multiple image sources to the projector, such as a computer and DVD player, you may want to switch from one image source to the other.

1. Make sure the connected image source you want to use is turned on.
2. For video image sources, insert a DVD or other video media and press its play button (if necessary).
3. Do one of the following:
 - Press the **Source Search** button on the projector or remote control until you see the image from the source you want.

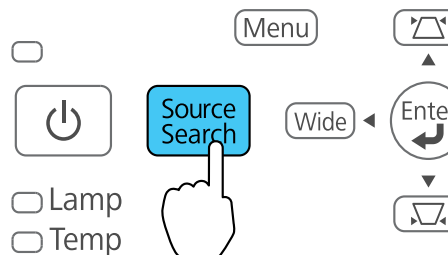

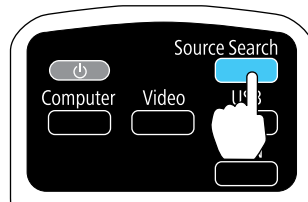

- Press the button for the source you want on the remote control. If there is more than one port for that source, press the button again to cycle through the sources.

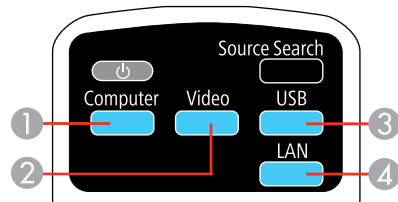

- 1 Computer port sources
- 2 Video and HDMI sources
- 3 USB port sources (computer display and external devices)
- 4 Network source (LAN)

Parent topic: [Using Basic Projector Features](#)

Projection Modes

Depending on how you positioned the projector, you may need to change the projection mode so your images project correctly.

- **Front/Upside Down** (default setting) flips the image over top-to-bottom to project upside-down from a wall or ceiling mount. This mode should also be used when you mount the projector vertically on a table to create an interactive work surface.
- **Front** lets you project from a table in front of the screen.
- **Rear/Upside Down** flips the image over top-to-bottom and horizontally to project from the wall or ceiling and behind a translucent screen.

- **Rear** flips the image horizontally to project from behind a translucent screen.

Note: The two Rear modes cannot be used with the interactive pens.

You can change the projection mode using the remote control or by changing the **Projection** setting in the **Extended** menu.

[Changing the Projection Mode Using the Remote Control](#)

[Changing the Projection Mode Using the Menu](#)

Parent topic: [Using Basic Projector Features](#)

Changing the Projection Mode Using the Remote Control

You can change the projection mode to flip the image over top-to-bottom.

1. Turn on the projector and display an image.
2. Hold down the **A/V Mute** button on the remote control for five seconds.

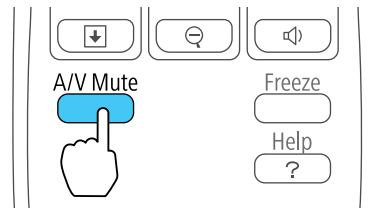

The image disappears briefly and reappears flipped top-to-bottom.

3. To change projection back to the original mode, hold down the **A/V Mute** button for five seconds again.

Parent topic: [Projection Modes](#)

Changing the Projection Mode Using the Menu

You can change the projection mode to flip the image over top-to-bottom and/or left-to-right using the projector menus.

1. Turn on the projector and display an image.
2. Press the **Menu** button.

3. Select the **Extended** menu and press **Enter**.

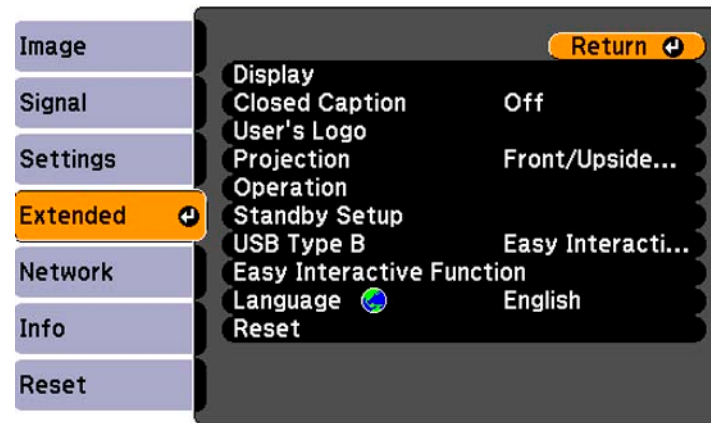

4. Select the **Projection** setting and press **Enter**.
5. Select a projection mode and press **Enter**.
6. Press **Menu** or **Esc** to exit the menus.

Parent topic: [Projection Modes](#)

Image Aspect Ratio

The projector can display images in different width-to-height ratios called aspect ratios. Normally the input signal from your video source determines the image's aspect ratio. However, for certain images you can change the aspect ratio to fit your screen by pressing a button on the remote control.

If you always want to use a particular aspect ratio for a certain video input source, you can select it using the projector's menus.

[Changing the Image Aspect Ratio](#)

[Available Image Aspect Ratios](#)

Parent topic: [Using Basic Projector Features](#)

Related references

[Image Quality Settings - Image Menu](#)

Changing the Image Aspect Ratio

You can change the aspect ratio of the displayed image to resize it.

1. Turn on the projector and switch to the image source you want to use.
2. Press the **Aspect** button on the remote control.

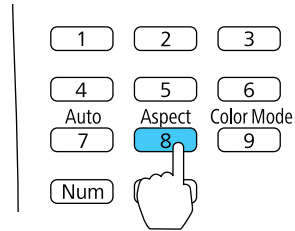

The shape and size of the displayed image changes, and the name of the aspect ratio appears briefly on the screen.

3. To cycle through the available aspect ratios for your input signal, press the **Aspect** button repeatedly.

Parent topic: [Image Aspect Ratio](#)

Available Image Aspect Ratios

You can select the following image aspect ratios, depending on the input signal from your image source.

Note: Black bands and cropped images may project in certain aspect ratios, depending on the aspect ratio and resolution of your input signal.

BrightLink 475Wi/485Wi

Aspect ratio setting	Description
Auto	Automatically sets the aspect ratio according to the input signal and the Resolution setting.
Normal	Displays images using the full projection area and maintains the aspect ratio of the image.
16:9	Converts the aspect ratio of the image to 16:9.

Aspect ratio setting	Description
Full	Displays images using the full width of the projection area, but does not maintain the aspect ratio.
Zoom	Displays images using the full width of the projection area and maintains the aspect ratio of the image.
Native	Displays images as is (aspect ratio and resolution are maintained).

BrightLink 480i

Aspect ratio setting	Description
Auto	Automatically sets the aspect ratio according to the input signal and the Resolution setting.
Normal	Displays images using the full projection area and maintains the aspect ratio of the image.
4:3	Displays images using the full projection area at 4:3 aspect ratio.
16:9	Converts the aspect ratio of the image to 16:9.

Note: The **Auto** aspect ratio setting is available only for HDMI image sources.

Parent topic: [Image Aspect Ratio](#)

Color Mode

The projector offers different Color Modes to provide optimum brightness, contrast, and color for a variety of viewing environments and image types. You can select a mode designed to match your image and environment, or experiment with the available modes.

If you always want to use a particular color mode for a certain video input source, you can select it using the projector menus.

[Changing the Color Mode](#)

[Available Color Modes](#)

[Turning On Auto Iris](#)

Parent topic: [Using Basic Projector Features](#)

Related references

[Image Quality Settings - Image Menu](#)

Changing the Color Mode

You can change the projector's Color Mode using the remote control to optimize the image for your viewing environment.

1. Turn on the projector and switch to the image source you want to use.
2. If you are projecting from a DVD player or other video source, insert a disc or other video media and press the play button, if necessary.
3. Press the **Color Mode** button on the remote control to change the Color Mode.

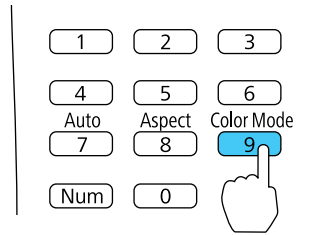

The image appearance changes and the name of the Color Mode appears briefly on the screen.

4. To cycle through all the available Color Modes for your input signal, press the **Color Mode** button repeatedly.

Parent topic: [Color Mode](#)

Available Color Modes

You can set the projector to use these Color Modes, depending on the input source you are using:

Color Mode	Description
Presentation	Best for color presentations in a bright room
Theatre	Best for movies projected in a dark room
Sports	Best for television images in a bright room (video, S-Video, or composite video input only)
Photo	Best for still images projected in a bright room
sRGB	Best for standard sRGB computer displays

Color Mode	Description
Blackboard	Best for presentations onto a green chalkboard (adjusts the colors accordingly)
Whiteboard	Best for presentations onto a whiteboard (adjusts the colors accordingly)
Dynamic	Best for video games in a bright room

Parent topic: [Color Mode](#)

Turning On Auto Iris

In certain color modes, you can turn on the Auto Iris setting to automatically optimize the image based on the brightness of the content you project.

1. Turn on the projector and switch to the image source you want to use.
2. Press the **Menu** button.
3. Select the **Image** menu and press **Enter**.

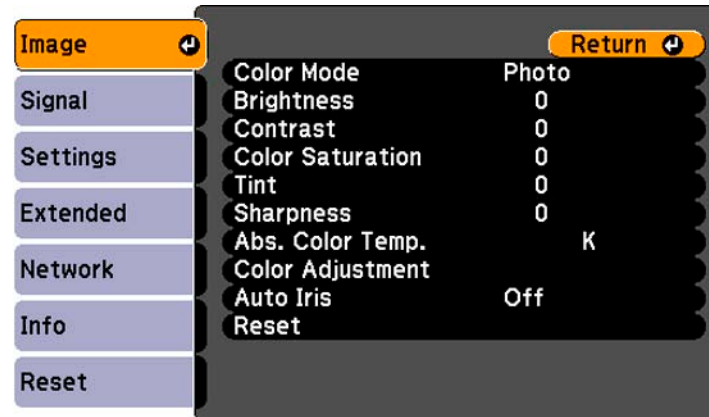

4. Select the **Auto Iris** setting and select **On**.

Note: You can turn **Auto Iris** on or off for each Color Mode that supports the feature. You cannot change the **Auto Iris** setting when you are using a **Closed Caption** setting.

5. Press **Menu** or **Esc** to exit the menus.

Parent topic: [Color Mode](#)

Controlling the Volume with the Volume Buttons

The volume buttons control the projector's internal speaker system or any external speakers you connected to the projector.

You must adjust the volume separately for each connected input source.

1. Turn on the projector and start a presentation that includes audio.
2. To lower or raise the volume, press the **Volume** buttons on the remote control.

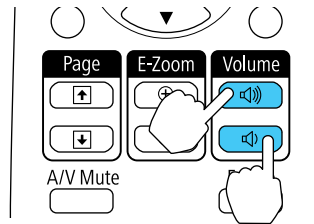

A volume gauge appears on the screen.

3. To set the volume to a specific level for an input source, you can set the volume using a projector menu.

Parent topic: [Using Basic Projector Features](#)

Related references

[Projector Feature Settings - Settings Menu](#)

Projecting a Slide Show

You can use your projector's Slideshow feature whenever you connect a USB device that contains compatible image files. This lets you quickly and easily display a slide show, and control it using the projector's remote control.

[Slideshow Features](#)

[Supported Slideshow File Types](#)

[Starting a Slide Show](#)

Parent topic: [Using Basic Projector Features](#)

Related concepts[USB Device Projection](#)**Related tasks**[Connecting a USB Device or Camera to the Projector](#)**Slideshow Features**

Your projector's Slideshow feature lets you do the following:

- Display individual images
- Present a slide show of all images in a folder

Parent topic: [Projecting a Slide Show](#)

Supported Slideshow File Types

You can project these types of files using the projector's Slideshow feature.

Note: For best results, place your files on media that is formatted in FAT16/32.

File contents	File type (extension)	Details
Image	.jpg	Make sure the file is not: <ul style="list-style-type: none">• CMYK format• Progressive format• Highly compressed• Above 8192 × 8192 resolution
	.bmp	Make sure the file resolution is not above 1280 × 800
	.gif	Make sure the file is not: <ul style="list-style-type: none">• Above 1280 × 800 resolution• Animated
	.png	Make sure the file resolution is not above 1280 × 800

Parent topic: [Projecting a Slide Show](#)

Starting a Slide Show

After connecting a USB device to the projector, you can switch to the USB input source and start your slide show.

Note: You can change the Slideshow operation options or add special effects by highlighting **Option** at the bottom of the screen and pressing **Enter**.

1. Press the **USB** button on the projector remote control.
The **Slideshow** screen appears.



2. Do the following as necessary to locate your files:
 - If you need to display files inside a subfolder on your device, press the arrow buttons to highlight the folder and press the **Enter** button.
 - To move back up a folder level on your device, highlight **Back to Top** and press **Enter**.
 - To view additional images in a folder, highlight **Next page** or **Previous page** and press **Enter**.
3. Do one of the following to start your slide show:
 - To display an individual image, press the arrow buttons to highlight the image and press **Enter**. (Press the **Esc** button to return to the file list screen.)

- To display a slide show of all the images in a folder, press the arrow buttons to highlight the **Slideshow** option at the bottom of the screen and press **Enter**.

Note: If any file names are longer than 8 characters or include unsupported symbols, the file names may be shortened or changed only in the screen display.

4. While projecting, use the following commands to control the display as necessary:
 - To rotate a displayed image, press the up or down arrow button.
 - To move to the next or previous image, press the left or right arrow button.
5. To stop the display, follow the on-screen instructions or press the **Esc** button.

[Slideshow Display Options](#)

Parent topic: [Projecting a Slide Show](#)

Related tasks

[Disconnecting a USB Device or Camera From the Projector](#)

Slideshow Display Options

You can select these display options when using the projector's Slideshow feature.



Setting	Options	Description
Display Order	Name Order	Displays files in name order
	Date Order	Displays files in date order

Setting	Options	Description
Sort Order	In Ascending	Sorts files in first-to-last order
	In Descending	Sorts files in last-to-first order
Continuous Play	On	Displays a slide show continuously
	Off	Displays a slide show one time through
Screen Switching Time	No	Does not display the next file automatically
	1 Second to 60 Seconds	Displays files for the selected time and switches to the next file automatically
Effect	Wipe	Transitions between images with a wipe effect
	Dissolve	Transitions between images with a dissolve effect
	Random	Transitions between images using a random variety of effects

Parent topic: [Starting a Slide Show](#)

Adjusting Projector Features

Follow the instructions in these sections to use your projector's feature adjustments.

[Shutting Off the Picture and Sound Temporarily](#)

[Stopping Video Action Temporarily](#)

[Zooming Into and Out of Images](#)

[Projector Security Features](#)

[Creating a User Pattern to Display](#)

Shutting Off the Picture and Sound Temporarily

You can temporarily turn off the projected picture and sound if you want to redirect your audience's attention during a presentation. Any sound or video action continues to run, however, so you cannot resume projection at the point that you stopped it.

If you want to display an image such as a company logo or picture when the presentation is stopped, you can set up this feature using the projector's menus.

1. Press the **A/V Mute** button on the remote control to temporarily stop projection and mute any sound.

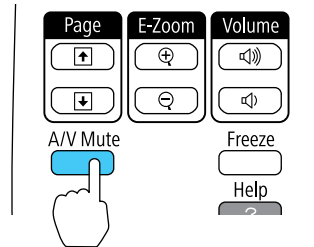

2. To turn the picture and sound back on, press **A/V Mute** again.

Parent topic: [Adjusting Projector Features](#)

Stopping Video Action Temporarily

You can temporarily stop the action in a video or computer presentation and keep the current image on the screen. Any sound or video action continues to run, however, so you cannot resume projection at the point that you stopped it.

Note: You can also stop video action using the interactive pens.

1. Press the **Freeze** button on the remote control to stop the video action.

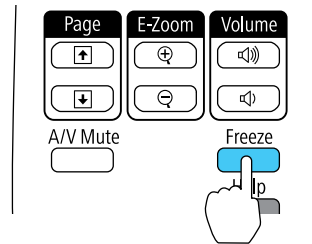

2. To restart the video action in progress, press **Freeze** again.

Parent topic: [Adjusting Projector Features](#)

Zooming Into and Out of Images

You can draw attention to parts of a presentation by zooming into a portion of the image and enlarging it on the screen.

Note: You can also zoom into your image using the interactive pens.

1. Press the **E-Zoom +** button on the remote control.

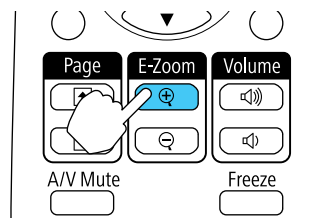

You see a crosshair on the screen indicating the center of the zoom area.

2. Use the following buttons on the remote control to adjust the zoomed image:
 - Use the arrow buttons to position the crosshair in the image area you want to zoom into.
 - Press the **E-Zoom +** button repeatedly to zoom into the image area, enlarging it as necessary.

- To pan around the zoomed image area, use the arrow buttons.
- To zoom out of the image, press the **E-Zoom** – button as necessary.
- To return to the original image size, press **Esc**.

Parent topic: [Adjusting Projector Features](#)

Projector Security Features

You can secure your projector to deter theft or prevent unintended use by setting up the following security features:

- Password security to prevent the projector from being turned on, and prevent changes to the startup screen and other settings.
- Button lock security to block operation of the projector using the buttons on the control panel.
- Security cabling to physically cable the projector in place.

[Password Security Types](#)

[Locking the Projector's Buttons](#)

[Installing a Security Cable](#)

Parent topic: [Adjusting Projector Features](#)

Password Security Types

You can set up these types of password security using one shared password:

- **Power On Protect** password prevents anyone from using the projector without first entering a password.
- **User's Logo Protect** password prevents anyone from changing the custom screen the projector can display when it turns on or when you use the A/V Mute feature. The presence of the custom screen discourages theft by identifying the projector's owner.
- **Network Protect** password prevents anyone from changing the network settings in the projector menus.

[Setting a Password](#)

[Selecting Password Security Types](#)

[Entering a Password to Use the Projector](#)

[Saving a User's Logo Image to Display](#)

Parent topic: [Projector Security Features](#)

Setting a Password

To use password security, you must set a password.

1. Hold down the **Freeze** button on the remote control until you see the Password Protect menu. This takes about five seconds.

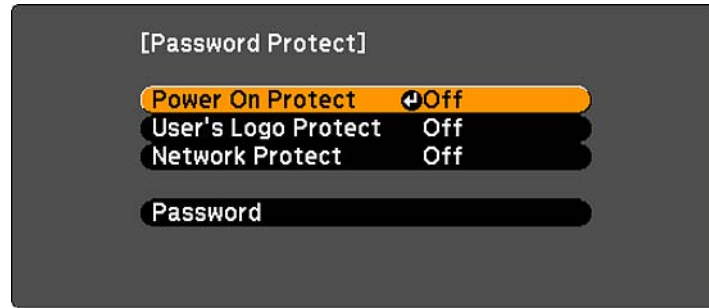

2. Press the down arrow to select **Password** and press **Enter**.
You see the prompt "Change the password?".
3. Select **Yes** and press **Enter**.
4. Hold down the **Num** button on the remote control and use the numeric buttons to set a four-digit password.

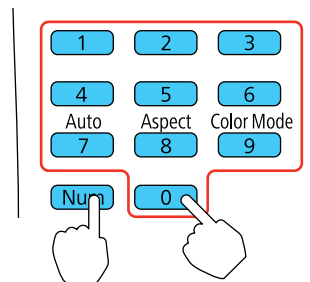

The password displays as **** as you enter it. Then you see the confirmation prompt.

5. Enter the password again.
You see the message "Password accepted."

6. Press **Esc** to return to the Password Protect menu.
7. Make a note of the password and keep it in a safe place in case you forget it.

Parent topic: [Password Security Types](#)

Selecting Password Security Types

After setting a password, you see the Password Protect menu. Select the password security types you want to use.

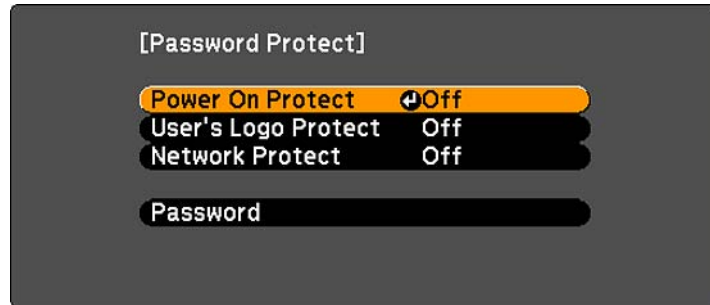

If you do not see this menu, hold down the **Freeze** button on the remote control for five seconds until the menu appears.

1. To prevent unauthorized use of the projector, select **Power On Protect**, press **Enter**, select **On**, press **Enter** again, and press **Esc**.
2. To prevent changes to the User's Logo screen or related display settings, select **User's Logo Protect**, press **Enter**, select **On**, press **Enter** again, and press **Esc**.
3. To prevent changes to network settings, select **Network Protect**, press **Enter**, select **On**, press **Enter** again, and press **Esc**.

You can attach the Password Protect sticker to the projector as an additional theft deterrent.

Note: Be sure to keep the remote control in a safe place; if you lose it, you will not be able to enter the password required to use the projector.

Parent topic: [Password Security Types](#)

Entering a Password to Use the Projector

If a password is set up and a **Power On Protect** password is enabled, you see a prompt to enter a password whenever you turn on the projector.

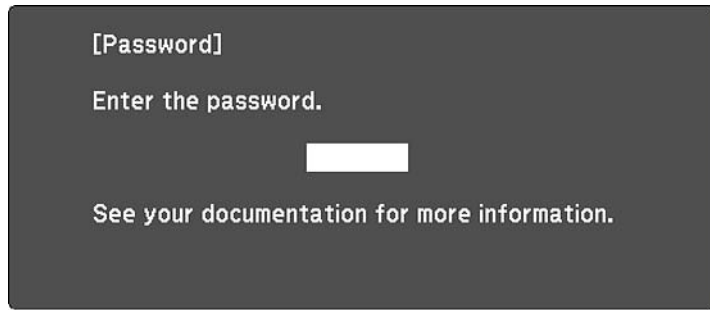

[0-9] :Enter

You must enter the correct password to use the projector.

1. Hold down the **Num** button on the remote control while you enter the password using the numeric buttons.

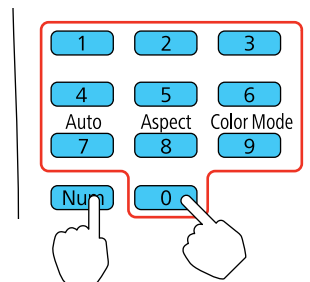

The password screen closes.

2. If the password is incorrect, the following may happen:
 - You see a "wrong password" message and a prompt to try again. Enter the correct password to proceed.
 - If you enter an incorrect password several times in succession, the projector displays a request code and a message to contact EPSON Support. When you contact EPSON Support, provide the displayed request code and proof of ownership for assistance in unlocking the projector.

Parent topic: [Password Security Types](#)

Saving a User's Logo Image to Display

You can transfer an image to the projector and then display it whenever the projector turns on. You can also display the image when the projector is not receiving an input signal or when you temporarily stop projection (using the A/V Mute feature). This transferred image is called the User's Logo screen.

The image you select as the User's Logo can be a photo, graphic, or company logo, which is useful in identifying the projector's owner to help deter theft. You can prevent changes to the User's Logo by setting up password protection for it.

1. Display the image you want to project as the User's Logo.
2. Press the **Menu** button, select the **Extended** menu, and press **Enter**.
3. Select the **User's Logo** setting and press **Enter**.

You see a prompt asking if you want to use the displayed image as a user's logo.

4. Select **Yes** and press **Enter**.

You see a selection box overlaying your image.

5. Use the arrow buttons on the remote control to surround the image area you want to use as the User's Logo and press **Enter**.

You see a prompt asking if you want to select this image area.

6. Select **Yes** and press **Enter**. (If you want to change the selected area, select **No**, press **Enter**, and repeat the last step.)

You see the User's Logo zoom factor menu.

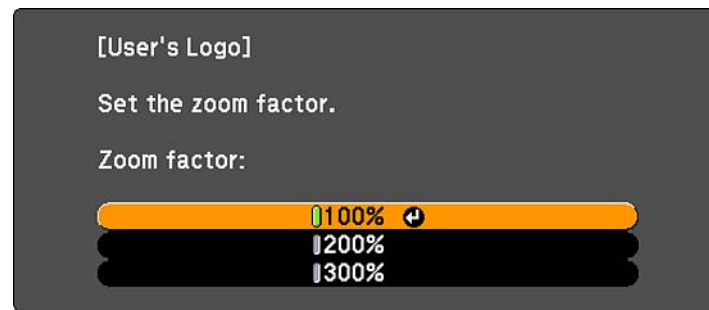

7. Select a zoom percentage and press **Enter**.

You see a prompt asking if you want to save the image as the User's Logo.

8. Select **Yes** and press **Enter**.

Note: It takes a few moments for the projector to save the image; do not use the projector, its remote control, or any connected equipment until it is finished.

You see a completion message.

9. Press **Esc** to exit the message screen.
10. Select the **Extended** menu and press **Enter**.
11. Select **Display** and press **Enter**.
12. Select when you want to display the User's Logo screen:
 - To display it whenever there is no input signal, select **Display Background** and set it to **Logo**.
 - To display it whenever you turn the projector on, select **Startup Screen** and set it to **On**.
 - To display it whenever you press the **A/V Mute** button, select **A/V Mute** and set it to **Logo**.

To prevent anyone from changing the User's Logo settings without first entering a password, set a password and enable User's Logo security.

Parent topic: [Password Security Types](#)

Locking the Projector's Buttons

You can lock the buttons on the projector's control panel to prevent anyone from using the projector. You can lock all the buttons or all the buttons except the power button.

1. Press the **Menu** button.
2. Select the **Settings** menu and press **Enter**.

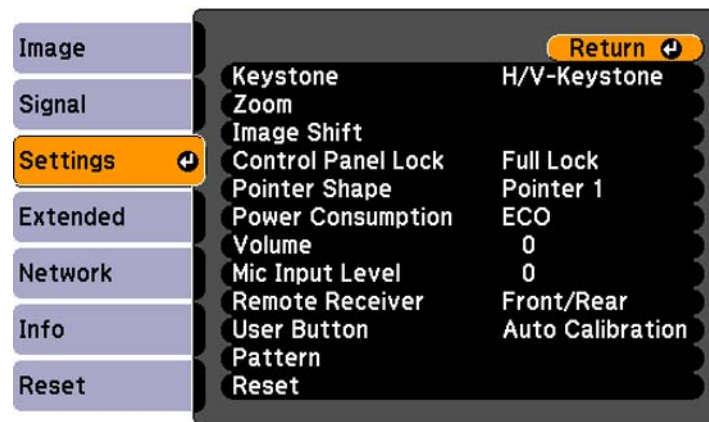

3. Select the **Control Panel Lock** setting and press **Enter**.
4. Select one of these lock types and press **Enter**:
 - To lock all of the projector's buttons, select **Full Lock**.
 - To lock all buttons except the power button, select **Partial Lock**.You see a confirmation prompt.
5. Select **Yes** and press **Enter**.

[Unlocking the Projector's Buttons](#)

Parent topic: [Projector Security Features](#)

Unlocking the Projector's Buttons

If the projector's buttons have been locked, hold the **Enter** button on the projector's control panel for seven seconds to unlock them.

Parent topic: [Locking the Projector's Buttons](#)

Installing a Security Cable

You can install two types of security cables on the projector to deter theft.

- Use the security slot on the back of the projector to attach a Kensington Microsaver Security system, available from Epson.
- Use the security cable attachment point on the projector to attach a wire cable and secure it to a room fixture or heavy furniture.

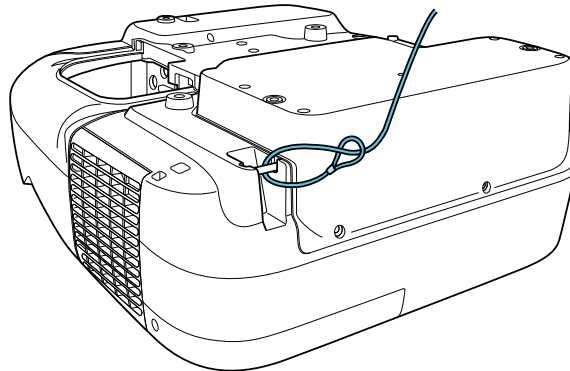

Parent topic: [Projector Security Features](#)

Creating a User Pattern to Display

You can transfer an image to the projector and then display it as a pattern to aid in presentations when you use the Pattern Display feature. This transferred image is called the User Pattern.

1. Display the image you want to project as the User Pattern from a connected computer or video source.
2. Press the **Menu** button, select the **Settings** menu, and press **Enter**.

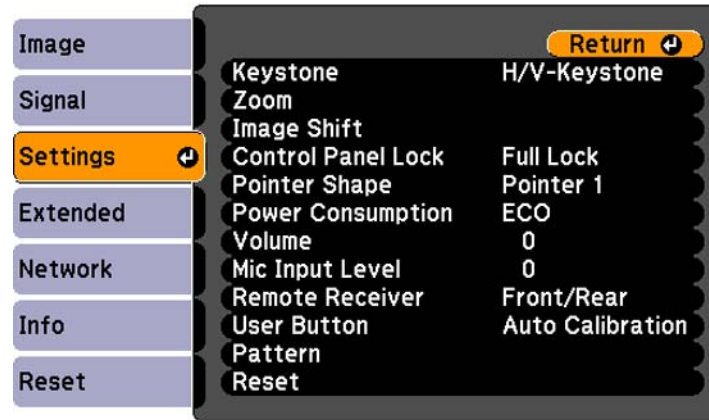

3. Select the **Pattern** setting and press **Enter**.
4. Select the **User Pattern** setting and press **Enter**.

You see a prompt asking if you want to use the displayed image as a User Pattern.

5. Select **Yes** and press **Enter**.

Note: It takes a few moments for the projector to save the image; do not use the projector, its remote control, or any connected equipment until it is finished.

You see a completion message.

6. Press **Esc** to exit the message screen.

Parent topic: [Adjusting Projector Features](#)

Related references

[Projector Feature Settings - Settings Menu](#)

Using the Interactive Pens

The BrightLink interactive pens turn any wall into an interactive whiteboard, either with or without a computer.

- With a computer, you can use Easy Interactive Tools. This software lets you use the pen as a mouse to annotate, save, and interact with content from your computer. Two people can annotate at the same time.
- Without a computer, you can use the built-in toolbar (one pen at a time). This lets you annotate images from a document camera, iPad, DVD player, or other source.

Follow the instructions in these sections to use the interactive pens.

[Using the Pens](#)

[Using BrightLink With a Computer](#)

[Easy Interactive Tools](#)

[Windows Tablet PC and Ink Tools](#)

[Using BrightLink Without a Computer](#)

Using the Pens

Your projector came with a blue pen and an orange pen, identified by the color on the end of the pen. You can use either pen with the built-in toolbar, or both pens at the same time (one of each color) with Easy Interactive Tools.

Make sure the batteries are installed.

Note: The pens turn off automatically after 20 minutes of inactivity. Slide the switch to turn the pen back on.

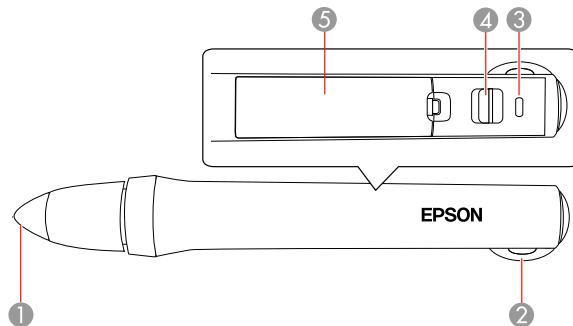

- 1 Pen tip
- 2 Attachment for optional strap or cord
- 3 Battery light
- 4 Power switch
- 5 Battery cover

1. To turn on the pen, slide the power switch.

The green light comes on briefly. If the battery is low, the light flashes.

Note: For best performance, hold the pen perpendicular to the board, as shown below. Do not cover the black section near the tip of the pen.

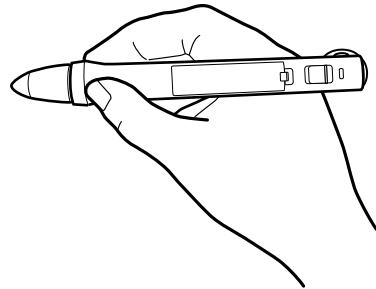

2. Do the following to use the pen as a mouse:
 - To left-click, tap the board.
 - To double-click, tap twice.
 - To right-click, press the board with the pen for about 3 seconds.
 - To click and drag, tap and drag with the pen.
 - To move the cursor, hover over the board without touching it.
3. When you are finished using the pen, slide the power switch to turn it off.

[Calibrating Automatically](#)

[Calibrating Manually](#)

Parent topic: [Using the Interactive Pens](#)

Related tasks

[Replacing the Pen Batteries](#)

Calibrating Automatically

Calibration coordinates the positioning of the pen with the location of your cursor. You only need to calibrate the first time you use your projector, and you do not need the pens or a computer for calibration. You should not need to calibrate again unless the projector or image is moved, or the image is resized.

Note: You can start Auto Calibration by pressing the **User** button on the remote control or by pressing the **Menu** button on the remote control as described below.

1. Press the **Menu** button, select the **Extended** menu, and press **Enter**.

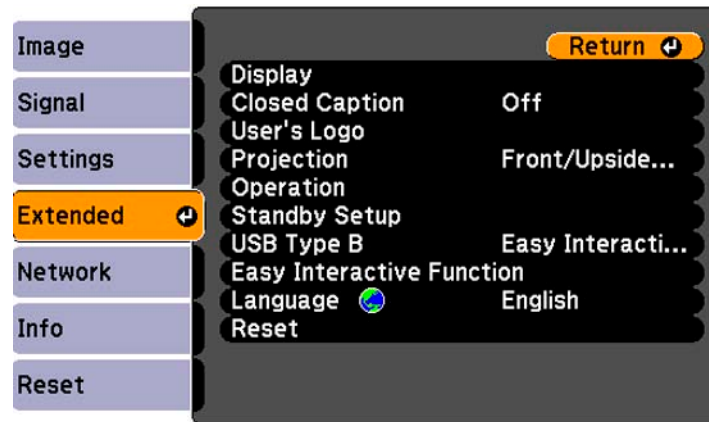

2. Select the **Easy Interactive Function** setting and press **Enter**.

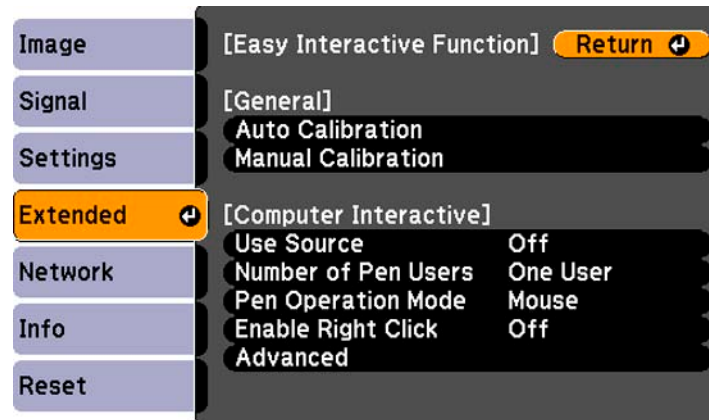

3. Select **Auto Calibration** and press **Enter**.

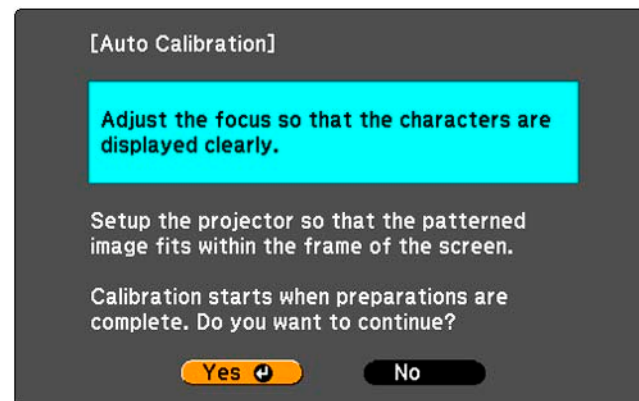

4. Adjust the focus if necessary, by opening the cover on the side of the projector and sliding the focus lever.
5. Press **Enter** to select **Yes**.
A pattern appears, and the system is calibrated. If you see a message that calibration failed, you need to calibrate manually.

The cursor location and pen position should match after calibration. If not, you may need to calibrate manually.

Parent topic: [Using the Pens](#)

Related tasks

[Calibrating Manually](#)

Calibrating Manually

If the cursor location and pen position do not match after auto calibration, you can calibrate manually.

1. Press the **Menu** button, select the **Extended** menu, and press **Enter**.

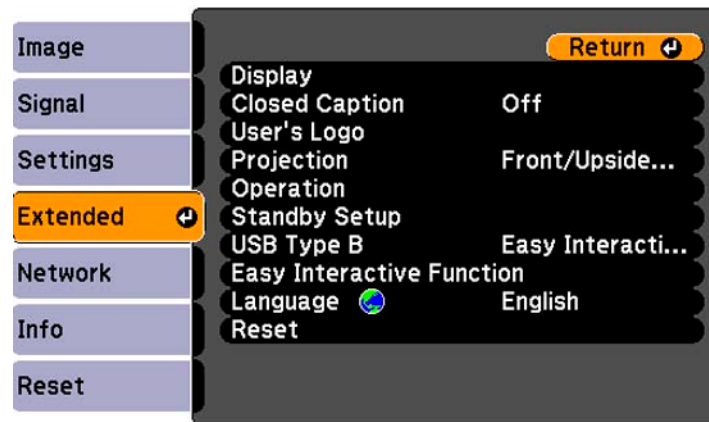

2. Select the **Easy Interactive Function** setting and press **Enter**.

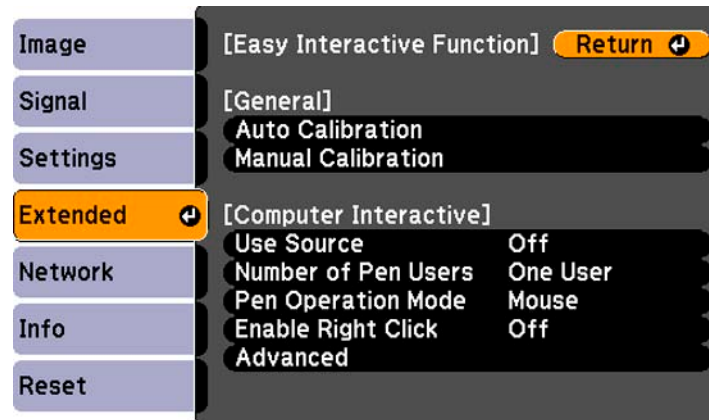

3. Select **Manual Calibration** and press **Enter**.

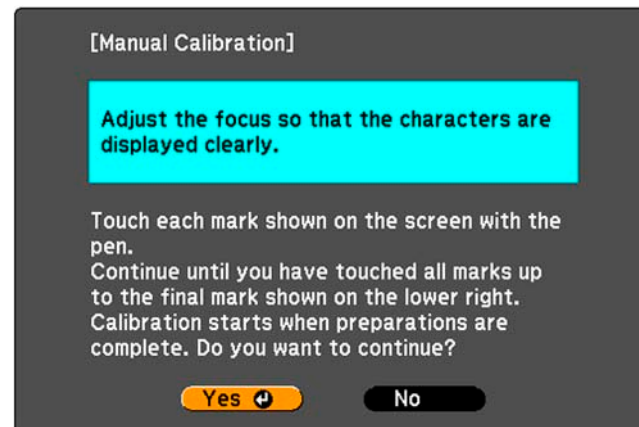

4. Adjust the focus if necessary, by opening the cover on the side of the projector and sliding the focus lever.
5. Press **Enter** to select **Yes**.
A flashing green circle appears in the upper left corner of your projected image.
6. Touch the center of the circle with the tip of the pen.

The circle disappears, and you see another circle lower than the first one.

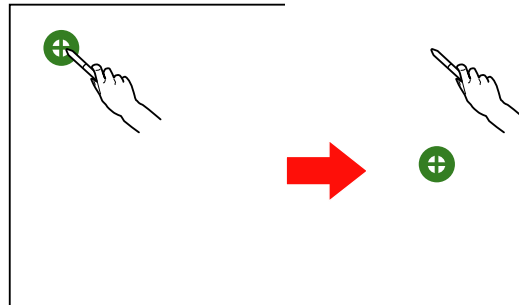

Note: For the most accurate calibration, make sure you touch the center of the circle.



7. Touch the center of the next circle, then repeat. When you get to the bottom of the column, the next circle appears at the top of a new column.

Note: Make sure you are not blocking the signal between the pen and the interactive receiver (next to the projection window on the projector).

If you make a mistake, press the **Esc** button on the remote control to go back to the previous circle. To restart the calibration process, press and hold the **Esc** button.

8. Continue until all of the circles disappear.

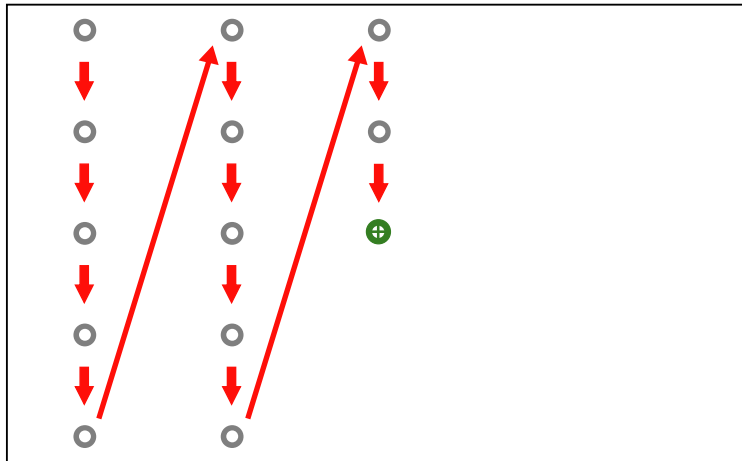

Parent topic: [Using the Pens](#)

Related tasks

[Calibrating Automatically](#)

Using BrightLink With a Computer

You can connect a computer to the projector and install the software from the CD labeled "Epson Projector Software for Easy Interactive Function." You can then do the following:

- Use one of the pens as a mouse to control your computer
- Use Easy Interactive Tools to annotate with both pens at the same time
- Save and print your annotations
- Use the Tablet PC input panel in Windows 7 or Windows Vista
- Use Ink Tools for annotation in Microsoft Office applications

[Adjusting the Pen Operation Area](#)

Parent topic: [Using the Interactive Pens](#)

Adjusting the Pen Operation Area

The pen operation area is normally adjusted automatically if you connect a different computer or adjust the computer's resolution. If you notice that the pen position is incorrect, you can adjust the pen area manually.

1. Project your computer's desktop.
2. Press the **Menu** button, select the **Extended** menu, and press **Enter**.

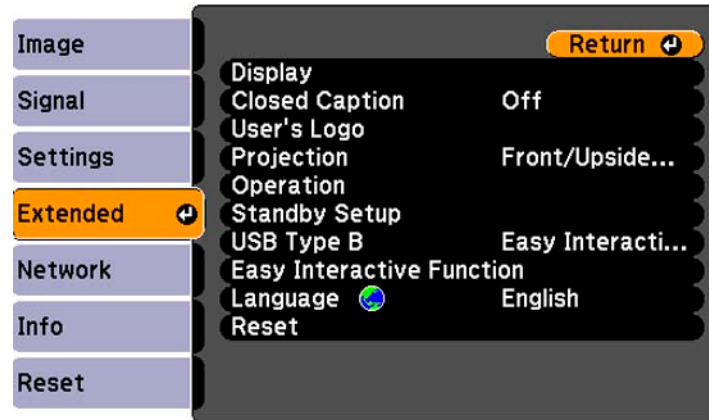

3. Select the **Easy Interactive Function** setting and press **Enter**.

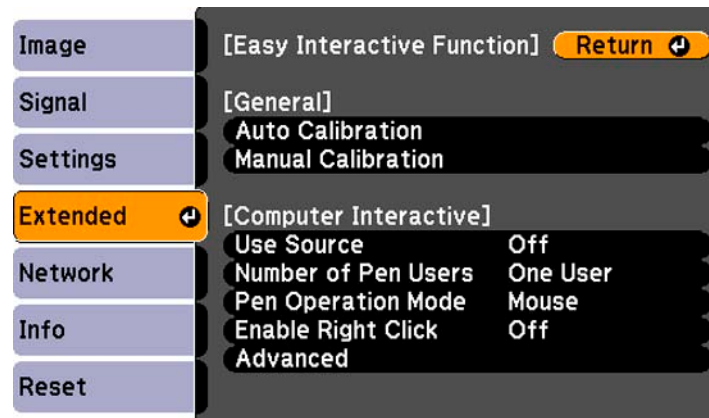

4. Select **Advanced** and press **Enter**.

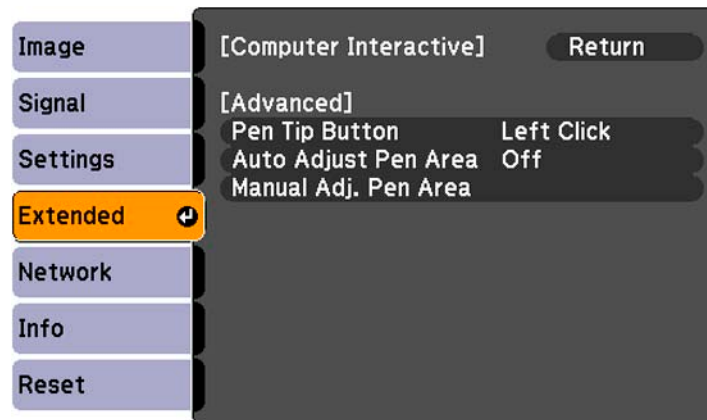

5. Select **Manual Adj. Pen Area** and press **Enter**.

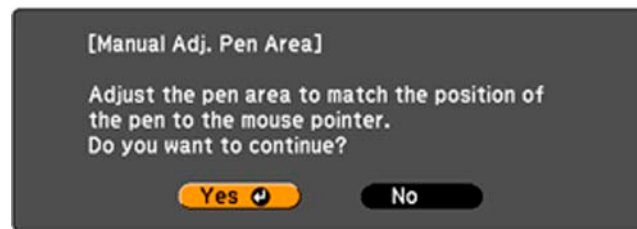

6. Press **Enter** to select **Yes**.
The mouse pointer moves toward the top left corner.
7. When the mouse pointer stops at the top left corner of the image, touch the tip of the pointer with the pen.
The mouse pointer moves toward the bottom right corner.
8. When the mouse pointer stops at the bottom right corner of the image, touch the tip of the pointer with the pen.

Parent topic: [Using BrightLink With a Computer](#)

Easy Interactive Tools

Your projector came with a CD containing the Easy Interactive Tools software for use with a computer. Easy Interactive Tools lets you use your interactive pen as a mouse to navigate, select, scroll, draw, save, and interact with projected content from your computer.

These two modes are available:

- Interactive mode displays the toolbar on the projected image and lets you use the pen as a mouse to open applications, access links, and operate scroll bars, for example (using one pen at a time). You can also annotate whatever is displayed from your computer (using both pens at the same time).
- Whiteboard mode lets you project one of 3 solid colors or 6 background patterns, and use the toolbar to write or draw on the background. You can also import images from your computer or a document camera. In whiteboard mode, two people can use the pens at the same time.

Note: Before using Easy Interactive Tools, make sure **Use Source** in the Extended menu is set to the interface port where your computer is connected.

[Easy Interactive Tools System Requirements](#)

[Installing Easy Interactive Tools](#)

[Starting and Exiting Easy Interactive Tools](#)

[Using the Easy Interactive Tools for Interactive Mode](#)

[Using Easy Interactive Annotation Tools](#)

[Using the Easy Interactive Tools for Whiteboard Mode](#)

[Using Easy Interactive Tools for Saving, Printing, and More](#)

Parent topic: [Using the Interactive Pens](#)

Related references

[Projector Setup Settings - Extended Menu](#)

Easy Interactive Tools System Requirements

Your computer system must meet the system requirements here to use Easy Interactive Tools.

Requirement	Windows	Mac
Operating system	Windows XP Professional, Home Edition, and Tablet PC Edition (32-bit); except for Service Pack 1	Mac OS X 10.4.x, 10.5.x, 10.6.x, or 10.7.x
	Windows Vista Ultimate, Enterprise, Business, Home Premium, and Home Basic (32-bit)	
	Windows 7 Ultimate, Enterprise, Professional, and Home Premium (32- and 64-bit); Home Basic (32-bit)	
CPU	Intel Pentium M 1.6 GHz or faster (Core2 Duo 1.2 GHz or faster recommended)	Power PC G4 1.5 GHz or faster (Core Duo 1.5 GHz or faster recommended)
Memory	512MB or more (1G or more recommended)	
Hard disk space	100MB or more	
Display	Resolution between 1024 x 768 and 1920 x 1080, 16-bit color or greater	

Parent topic: [Easy Interactive Tools](#)

Installing Easy Interactive Tools

The Easy Interactive Tools software is included on the CD labeled "Epson Projector Software for Easy Interactive Function." This CD also includes the Easy Interactive Driver, which is required for BrightLink pen usage on a Mac.

Note: You can also download the software from the Epson website. Visit Epson's support site ([U.S. downloads](#) or [Canadian downloads](#)).

1. Insert the CD labeled "Epson Projector Software for Easy Interactive Function" in your drive.
2. Do one of the following:
 - **Windows:** If you see the AutoPlay window, select **Run EIN_TTWInst.exe**. If you see the User Account Control screen, select **Yes** or **Continue**.
 - **Mac OS X:** Double-click the **Install** icon in the Epson window.
3. Follow the on-screen instructions to install the software.
Make sure you select **Register to Startup** (Windows) or **Start up** (Mac OS X).

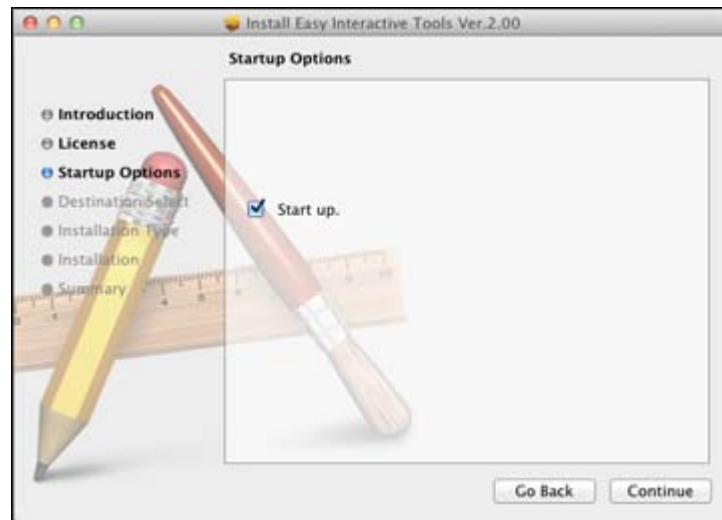
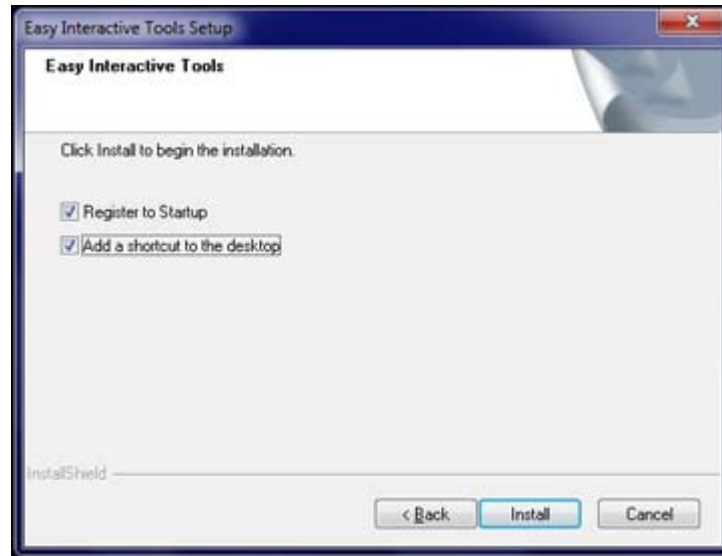



Note: In Mac OS X, select **Easy Install** to include the Easy Interactive Driver in the installation. You will need to restart after installing the Easy Interactive Driver.

Parent topic: [Easy Interactive Tools](#)



Starting and Exiting Easy Interactive Tools

Make sure Easy Interactive Tools is installed on your computer, and the computer is connected to the projector and the interactive module.

1. Turn on your computer and wait until you see its desktop image projected.
2. To start Easy Interactive Tools, do one of the following:
 - **Windows:** Double-click the **Easy Interactive Tools** icon on your desktop or select  or **Start > All Programs** or **Programs > EPSON Projector > Easy Interactive Tools**.
 - **Mac OS X:** Select **Applications > Easy Interactive Tools > Easy Interactive Tools**.

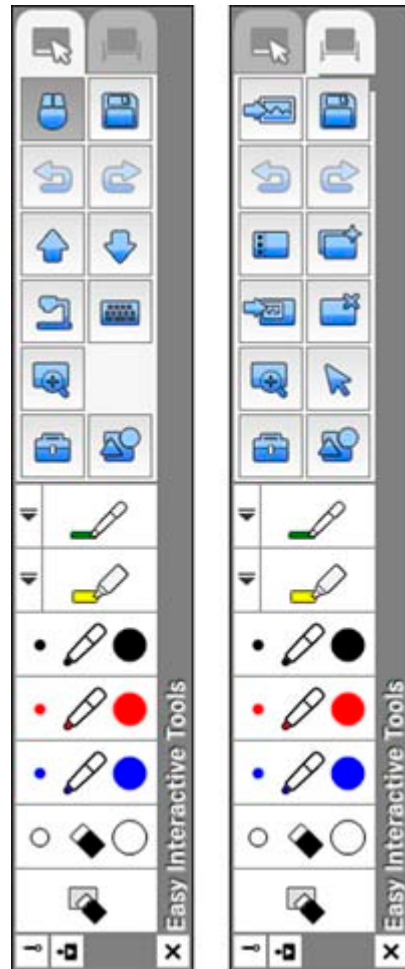
The Easy Interactive Toolbar appears on the projected image, and an  arrow appears on the other side of the image.



Note: The illustration shows the interactive mode toolbar on the left, and the whiteboard mode toolbar on the right. You can select the  Close icon to hide the toolbar, then select the  arrow to redisplay the toolbar.

3. To exit Easy Interactive Tools, select the **X** in the lower right corner of the toolbar.

Parent topic: [Easy Interactive Tools](#)

Using the Easy Interactive Tools for Interactive Mode

You can use the pen as a mouse and add annotations to your presentations or other work displayed from your computer. Follow the instructions in these sections to use the tools for interactive mouse mode.

[Easy Interactive Tools for Interactive Mode](#)

[Using the On-Screen Keyboard](#)





[Using a Document Camera With Easy Interactive Tools](#)









[Using the Magnifier](#)

Parent topic: [Easy Interactive Tools](#)

Easy Interactive Tools for Interactive Mode



	Switch to interactive mode
	Switch to whiteboard mode
	Toggle between mouse and pen modes
	Save the current screen

	Undo multiple operations (one at a time)
	Redo multiple operations (one at a time)
	Page up in a browser or other software program
	Page down in a browser or other software program
	Display the image from a document camera connected to the computer via USB
	Use an on-screen keyboard to enter text on a website or in a browser or other software program
	Use the magnifier to display an enlarged view of the image at the center of the screen
	Display additional tools for saving, printing, and more
	Insert a circle, square, triangle, or other shape

Parent topic: [Using the Easy Interactive Tools for Interactive Mode](#)

Using the On-Screen Keyboard

You can enter text in a browser or other program, such as a word processor or spreadsheet.

1. Open your internet browser or other program.

2. Select the  Keyboard tool.

You see the on-screen keyboard.



3. Tap on the projected field where you want to enter text.
4. Select the letters and numbers on the on-screen keyboard.

Parent topic: [Using the Easy Interactive Tools for Interactive Mode](#)

Using a Document Camera With Easy Interactive Tools





You can connect a document camera to your computer and use Easy Interactive Tools to annotate and work with any image projected from the camera.

1. Connect a document camera to your computer's USB port and focus on the image you want to project.

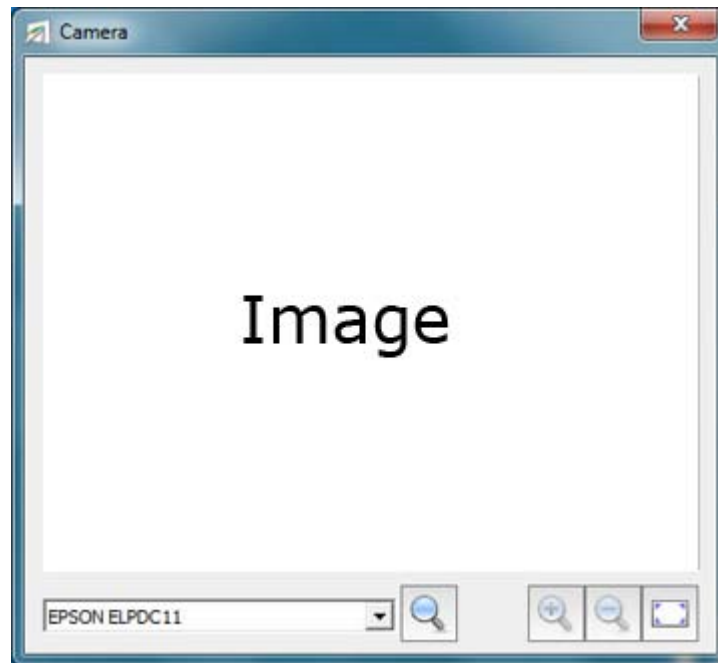
2. Select the  Camera tool.

You see a window like this:



3. Select the camera you want to use from the drop-down list.
4. Do one of the following to work with the image if necessary:
 - To search among connected sources, select the  icon.
 - To zoom in, select the  icon.
 - To zoom out, select the  icon.
 - To display a full-screen image from the camera, select the  icon.
5. When you are done, close the camera window.

Parent topic: [Using the Easy Interactive Tools for Interactive Mode](#)



Using the Magnifier

You can use the Magnifier tool to zoom in on a section of your projected image.

1. Select the  Magnifier tool.

You see a window like this:



2. Drag the Magnifier window to the area you want to enlarge.
3. Do the following to adjust the magnification as necessary:
 - To zoom in, select the  icon.
 - To zoom out, select the  icon.
4. When you are done, close the Magnifier window.

Parent topic: [Using the Easy Interactive Tools for Interactive Mode](#)

Using Easy Interactive Annotation Tools

Follow the instructions in these sections to use the Easy Interactive Tools for annotation.

[Easy Interactive Annotation Tools](#)







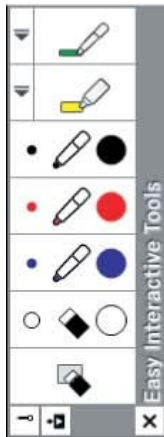

[Selecting Line Width and Color With Easy Interactive Tools](#)



Parent topic: [Easy Interactive Tools](#)

Easy Interactive Annotation Tools

The annotation tools shown here appear on the lower half of the toolbar and are available in all modes.



	Change custom pen color and width
	Write or draw with custom pen
	Change highlighter pen color and width
	Write or draw with transparent highlighter pen
	Write or draw with black pen (fine point on left, thick point on right)
	Write or draw with red pen (fine point on left, thick point on right)
	Write or draw with blue pen (fine point on left, thick point on right)
	Use the eraser (thin width on left, thick width on right)
	Clear all annotations (select Undo to restore annotations)

	Toggle between hiding the toolbar after use and showing it continuously
	Minimize the toolbar
	Exit Easy Interactive Tools

Parent topic: [Using Easy Interactive Annotation Tools](#)



Selecting Line Width and Color With Easy Interactive Tools

You can select the color and line width for both the custom Pen and the Highlighter tools.

1. Select the  icon next to the custom Pen or Highlighter annotation tool.

A box like the following appears:



2. Select the line width and color you want to use for the Pen or Highlighter tools.
3. Select the  or  tool, then use the pen to write or draw on the projection surface.

Parent topic: [Using Easy Interactive Annotation Tools](#)

Using the Easy Interactive Tools for Whiteboard Mode

You can write or draw on a blank surface, add background images, and save your pages. Follow the instructions in these sections to use the tools for whiteboard mode.

[Easy Interactive Tools for Whiteboard Mode](#)





[Using the Shapes Tool in Whiteboard Mode](#)











Parent topic: [Easy Interactive Tools](#)

Easy Interactive Tools for Whiteboard Mode

To display the whiteboard tools shown here, select the  Whiteboard icon on the toolbar.



	Switch to interactive mode
	Switch to whiteboard mode
	Select from 6 background patterns and 3 solid colors, or display an image file or an image from a document camera
	Save the current screen

	Undo multiple operations (one at a time)
	Redo multiple operations (one at a time)
	Display a list of pages currently being edited
	Open a new page
	Insert an image from a file or from a document camera connected to the computer
	Delete the current page
	Use the magnifier to display an enlarged view of the image at the center of the screen
	Display a cursor that you can use to adjust the size or position of an inserted image
	Display additional tools for saving, printing, and more
	Insert a circle, square, triangle, or other shape

Parent topic: [Using the Easy Interactive Tools for Whiteboard Mode](#)

Using the Shapes Tool in Whiteboard Mode

You can add a variety of shapes to your projected image and select the color and line width.

1. Select the  Shapes tool.

The Shapes box opens:



2. Select the line width, color, and shape you want to create, or select the  Line tool to define your own shape.
3. Drag the pen on the projection surface to draw the shape you want.

Parent topic: [Using the Easy Interactive Tools for Whiteboard Mode](#)

Using Easy Interactive Tools for Saving, Printing, and More

Follow the instructions in these sections to use the tools that let you save and print your annotated pages, adjust settings, access help, and perform other special functions.

[Easy Interactive Tools for Saving, Printing, and More](#)

[Working With the Page List](#)

[Saving Your Pages](#)

[Selecting Language and General Settings](#)







Parent topic: [Easy Interactive Tools](#)

Easy Interactive Tools for Saving, Printing, and More

To display the additional tools shown here, select the  Other tools icon on the interactive or whiteboard toolbar.

Note: Only the first 4 tools are available in whiteboard mode.



	Display a spotlight effect that hides most of the image and reveals a circular area. Drag the spotlight frame to reveal different parts of the image.
	Cover the projected image with a shade. Drag the sides to move or resize the shaded area.
	Print the currently displayed image. In whiteboard mode, you can print all of the current pages or select the ones you want.
	Open the settings screen, which lets you select general settings, language, and settings for saving your pages.
	Change the next pen tap to a right-click (interactive mouse mode only)
	Display Help information for Easy Interactive Tools (interactive mouse mode only)

Parent topic: [Using Easy Interactive Tools for Saving, Printing, and More](#)

Working With the Page List

You can display thumbnail images of the pages you are working with in the current Easy Interactive Tools session.

1. Select the  Page list tool.

Thumbnail images of the current pages open on the side of your screen:

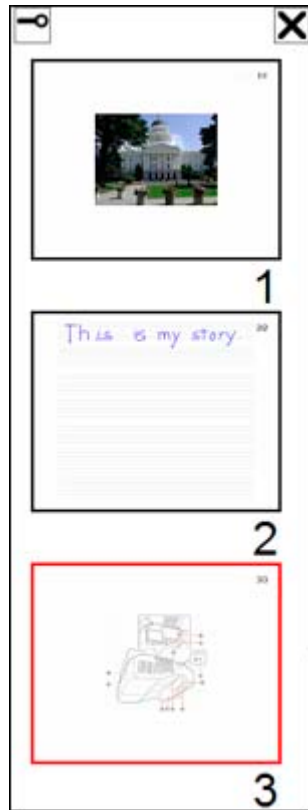

2. Do one of the following:

- To keep the page list open, select the  icon.
- To close the page list, select the **X** in the upper right corner.

Parent topic: [Using Easy Interactive Tools for Saving, Printing, and More](#)



Saving Your Pages

You can save your screen or pages as .jpg, .bmp, .png, or .pdf files and select the location where you want to store your files.

To save as .jpg files in your **Documents > Easy Interactive Tools** folder, simply select the  Save tool. Easy Interactive Tools names your file automatically based on the date and time. You can save the

current screen with annotations in interactive mode, or all the pages in the current session in whiteboard mode.

You can also select other locations and formats for saving your files, as described here. If you save as PDF, for example, all your whiteboard pages are combined in one file.

1. Select the  Keyboard tool.
The on-screen keyboard is displayed.
2. Select the  Other tools icon.
You see additional tools.
3. Select the  Settings tool.
The Settings window opens.
4. Select the **Save Settings** tab.
You see a screen like the following:

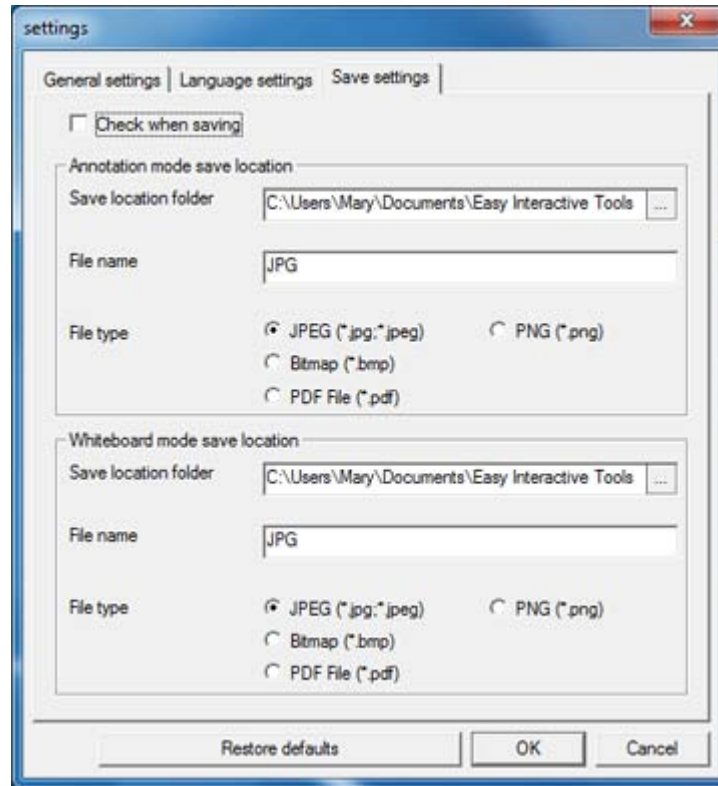

5. Select the location, file name, and file type for saving annotation mode and whiteboard mode pages. Easy Interactive Tools will automatically add the date and time to each file you save.
6. If you want to select different settings each time you save, select the **Check when saving** checkbox.
7. Select **OK** to close the Settings window.
8. When you want to save, select the  Save tool.

If you selected **Check when saving**, the on-screen keyboard is displayed, along with a window like the following:



9. Select the location and file type and enter a file name using the on-screen keyboard if necessary.

10. Select **Save**.

Parent topic: [Using Easy Interactive Tools for Saving, Printing, and More](#)

Selecting Language and General Settings

You can change the following settings in Easy Interactive Tools:

- Toolbar size
- Page list display position
- Spotlight shape
- Language (Windows only)

1. Select the  Other tools icon.

You see additional tools.

2. Select the  Settings icon.

The Settings window opens.

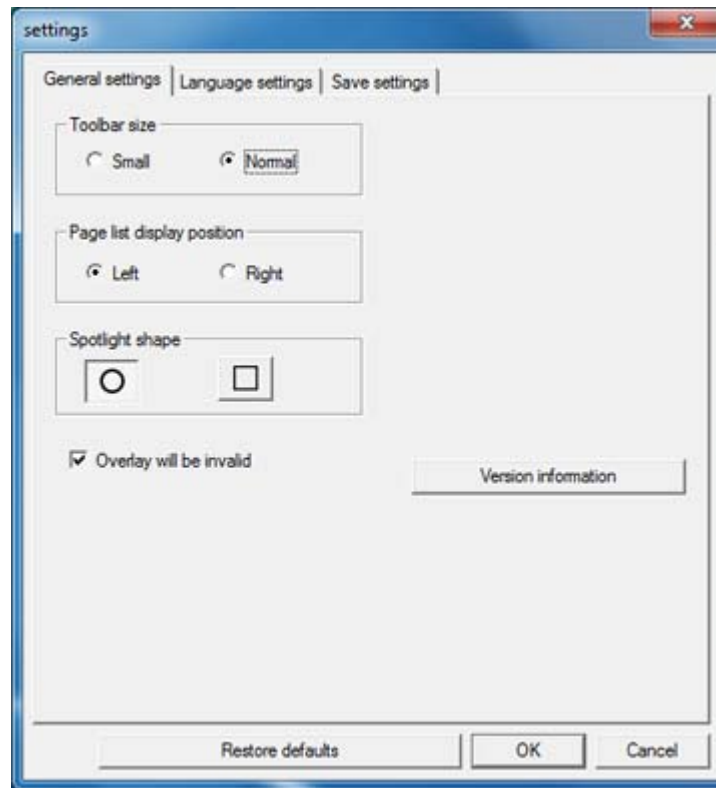

3. Select the toolbar size, page list display position, and spotlight shape.
4. If you want to change the language, select the **Language settings** tab, then select the language you want.
5. Select **OK** to close the Settings window.

Parent topic: [Using Easy Interactive Tools for Saving, Printing, and More](#)

Windows Tablet PC and Ink Tools

If you are using Windows 7 or Windows Vista, you can use the Tablet PC and Ink tools to add handwritten input and annotations to your work.

[Enabling Windows Tablet PC and Ink Features](#)

[Using Windows Tablet PC and Ink Features](#)

Parent topic: [Using the Interactive Pens](#)

Enabling Windows Tablet PC and Ink Features

If you want to use the Tablet PC and Ink features in Windows 7 or Vista, you need to adjust the pen settings in the Extended menu.

1. Press the **Menu** button, select the **Extended** menu, and press **Enter**.

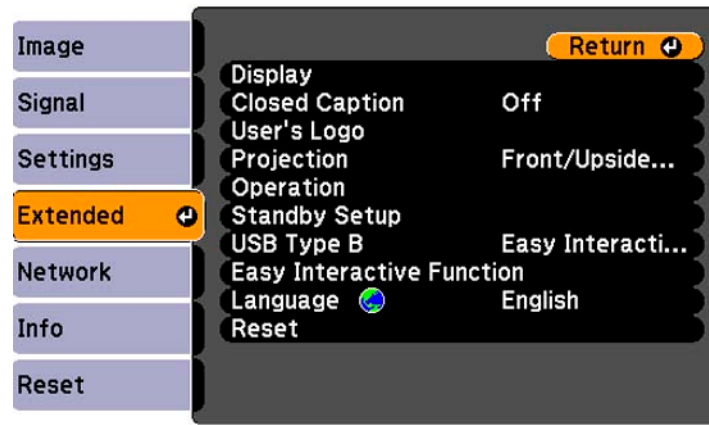

2. Select the **Easy Interactive Function** setting and press **Enter**.

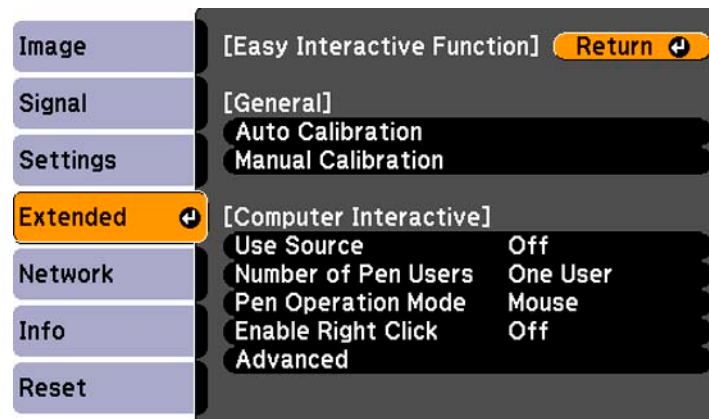

3. Select **Number of Pen Users** and press **Enter**.
4. Select **One User** and press **Enter**.
5. Press **Esc** on the remote control to return to the Easy Interactive Function screen.
6. Select **Pen Operation Mode** and press **Enter**.
7. Select **Pen** and press **Enter**.

Parent topic: [Windows Tablet PC and Ink Tools](#)

Using Windows Tablet PC and Ink Features

If you are using Windows 7 or Windows Vista, you can use the Tablet PC input panel to add handwritten input and convert it to text.

If you have Microsoft Office 2003 or later, you can also use the Ink function to add handwritten notes to a Word document, Excel spreadsheet, or PowerPoint presentation.

Note: Option names for the annotation functions may vary depending on your version of Microsoft Office.

- To open the Tablet PC input panel, select  > **All Programs > Accessories > Tablet PC > Tablet PC Input Panel**.

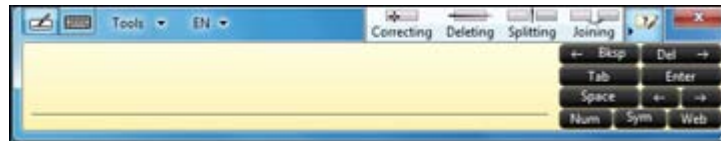

You can write in the box using the pen, then select from a variety of options to edit and convert the text.

- To add Ink annotations in Microsoft Office applications, select the **Review** menu, then select **Start Inking**.

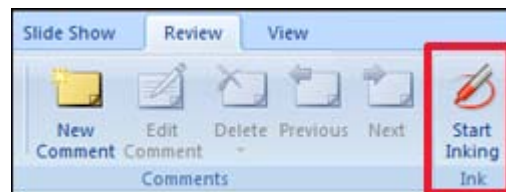

You can select from a variety of Ink Tools:



- To annotate your PowerPoint slides in Slideshow mode, press and hold the pen against the projection surface to right-click, then select **Pointer Options > Pen** from the pop-up menu.

Note: This also works in Windows XP.

For more information about these features, see your Windows Help.

Parent topic: [Windows Tablet PC and Ink Tools](#)

Using BrightLink Without a Computer

You can use the pens to write or draw on the projection surface without connecting a computer. This lets you annotate images from a document camera, iPad, DVD player, or other source.

These two modes are available:

- Annotation mode displays the built-in toolbar on whatever image is being projected from a document camera, iPad, or other source.
- Whiteboard mode lets you project a white or black screen or one of 4 background patterns, and use the toolbar to write or draw as you would on a chalkboard or dry erase board.

Note: The built-in toolbar is not available when you are projecting from a computer source.

[Using the Built-in Toolbar](#)

[Built-in Tools for Use Without a Computer](#)

[Zooming Images Using the Built-in Toolbar](#)

[Using the Built-in Whiteboard Mode](#)

[Changing Pen Width and Color Using the Built-in Toolbar](#)

Parent topic: [Using the Interactive Pens](#)

Using the Built-in Toolbar

You can use either pen with the built-in toolbar, but not both pens at the same time.

1. Press one of the Source buttons on the remote control to select the source for the image you want to annotate. If you simply want to use a blank screen, press the **Computer** button and select **Computer2** or another unused source.

Note: You cannot use the built-in toolbar if you select the same source that is selected for Easy Interactive Tools in the Extended menu.

2. To activate the toolbar, tap the projection surface with the pen.

You see  arrow icons on the left and right side of the projected image.

Note: The toolbar arrows disappear if they are not used. To make them reappear, tap the projection surface with the pen.

3. To display the toolbar, select one of the  arrows.

Note: You can use the pen to move the arrows up or down.

4. To close the toolbar, select the  icon at the bottom of the toolbar.

Note: If you want to hide the toolbar automatically after drawing, select the  icon at the bottom of the toolbar.

Parent topic: [Using BrightLink Without a Computer](#)

Related references

[Projector Setup Settings - Extended Menu](#)







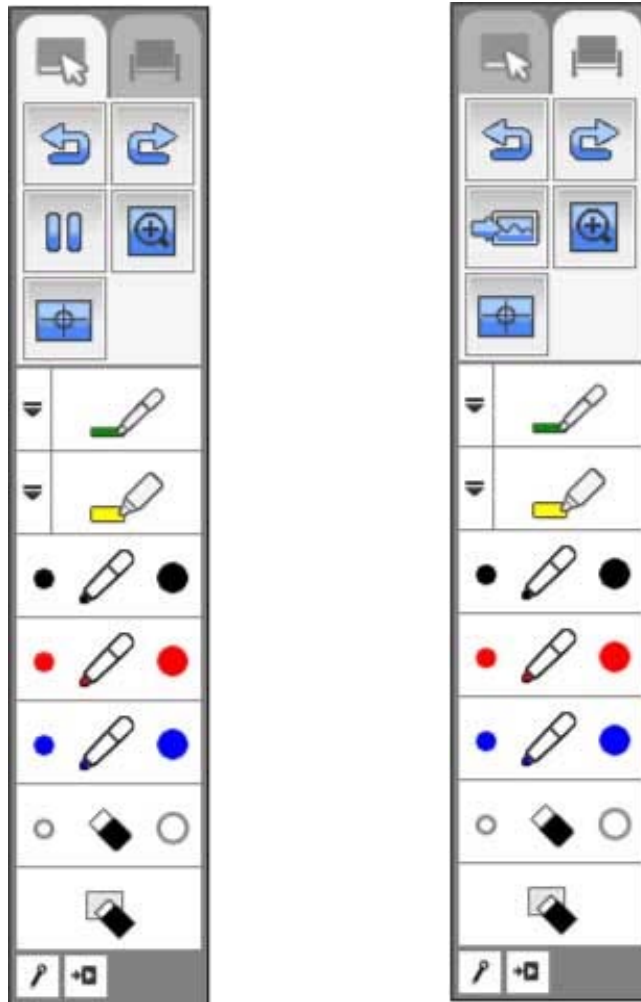

Built-in Tools for Use Without a Computer



The built-in toolbar is embedded in the projector and provides fewer functions than Easy Interactive Tools. For example, you cannot save your work with the built-in toolbar. If you want to save, connect a computer to the projector and use Easy Interactive Tools.

In the following illustration, the annotation mode tools are shown on the left, and the whiteboard mode tools on the right:



	Switch to annotation mode
---	---------------------------





	Switch to whiteboard mode
	Undo the last annotation
	Redo the last undo
	Freeze/continue video action
	Select a white or black background or one of 4 patterns
	Zoom into and out of image
	Repeat calibration
	Change custom pen color and width
	Write or draw free-form lines with custom pen
	Change highlighter pen color
	Write or draw free-form lines with transparent highlighter pen
	Black pen (fine point on left, thick on right)
	Red pen (fine point on left, thick on right)
	Blue pen (fine point on left, thick on right)
	Eraser (thin width on left, thick on right)

	Clear all annotations
	Hide the toolbar after each annotation
	Close the toolbar

Parent topic: [Using BrightLink Without a Computer](#)

Zooming Images Using the Built-in Toolbar

You can use the pen to zoom in and scroll around your enlarged image, then zoom out when you are done.



1. Select the  E-zoom tool, then tap the image where you want to zoom in.
You see a target on the image, which you can move if necessary.
2. Select the  E-zoom tool again to increase the magnification, up to 24 times.
3. Do one of the following to adjust the image if necessary:
 - Drag the pen to scroll around the image.
 - Select the  icon reduce the image.
 - Select the  icon to return to the original size.
4. When you are done, select the  icon to exit the E-zoom function.

Parent topic: [Using BrightLink Without a Computer](#)

Using the Built-in Whiteboard Mode



In whiteboard mode, you can project a solid or patterned background, and then write or draw on it as you would on a chalkboard or dry erase board.

1. Select the  Whiteboard tool on the built-in toolbar.
You see a white background.



2. If you want to change the background, do the following:
 - Select the  Background tool.
 - Select a black background or one of 4 different patterns.
 - Select the right arrow icon to close the selection window.
3. Do one of the following to write or draw on the background.
 - To erase, select the  Eraser tool.
 - To clear the whole screen, select the  Clear all tool.

Parent topic: [Using BrightLink Without a Computer](#)

Changing Pen Width and Color Using the Built-in Toolbar

When you use the  custom Pen, you can select from 8 colors and 4 line widths. For the  Highlighter, you can select from 2 colors.

Note: You can also select the Black, Red, or Blue pen on the toolbar, and select the small circle on the left of the pen for a thin line, or the large circle on the right for a thick line.

1. Select the  arrow next to the  custom Pen or  Highlighter pen on the toolbar.
2. Select the color and line width you want.
3. Select the right arrow icon to close the selection window.

Parent topic: [Using BrightLink Without a Computer](#)

Adjusting the Menu Settings

Follow the instructions in these sections to access the projector menu system and change projector settings.

[Using the Projector's Menus](#)

[Image Quality Settings - Image Menu](#)

[Input Signal Settings - Signal Menu](#)

[Projector Feature Settings - Settings Menu](#)

[Projector Setup Settings - Extended Menu](#)

[Projector Network Settings - Network Menu](#)

[Projector Information Display - Info Menu](#)

[Projector Reset Options - Reset Menu](#)

Using the Projector's Menus

You can use the projector's menus to adjust the settings that control how your projector works. The projector displays the menus on the screen.

1. Press the **Menu** button on the control panel or remote control.

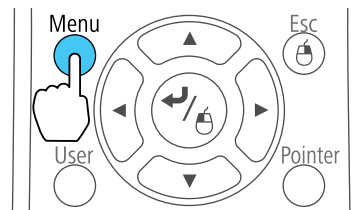

You see the menu screen displaying the Image menu settings.

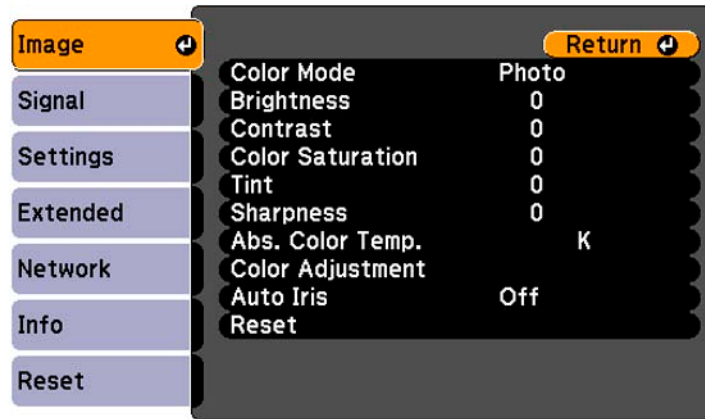

2. Press the up or down arrow buttons to move through the menus listed on the left. The settings for each menu are displayed on the right.

Note: The available settings depend on the current input source.

3. To change settings in the displayed menu, press **Enter**.
4. Press the up or down arrow button to move through the settings.
5. Change the settings using the buttons listed on the bottom of the menu screens.
6. To return all the menu settings to their default values, select **Reset**.
7. When you finish changing settings on a menu, press **Esc**.
8. Press **Menu** or **Esc** to exit the menus.

Parent topic: [Adjusting the Menu Settings](#)

Image Quality Settings - Image Menu

Settings on the Image menu let you adjust the quality of your image for the input source you are currently using. The available settings depend on the currently selected input source.

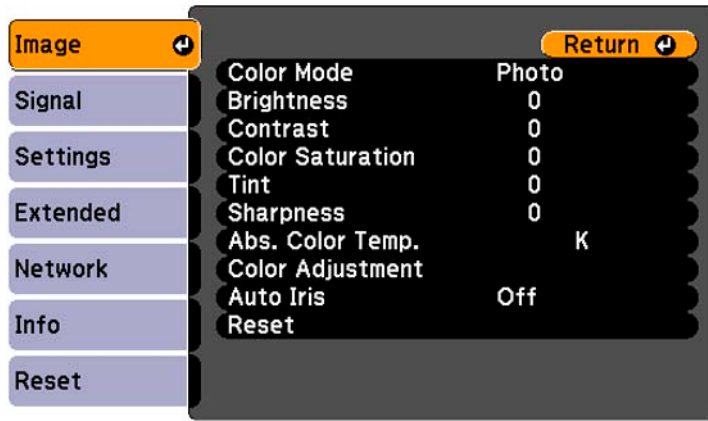

To change settings for an input source, make sure the source is connected and select that source.

Setting	Options	Description
Color Mode	See the list of available Color Modes	Adjusts the vividness of image colors for various image types and environments
Brightness	Varying levels available	Lightens or darkens the overall image
Contrast	Varying levels available	Adjusts the difference between light and dark areas of the image
Color Saturation	Varying levels available	Adjusts the intensity of the image colors
Tint	Varying levels available	Adjusts the balance of green to magenta tones in the image
Sharpness	Varying levels available	Adjusts the sharpness or softness of image details
Abs. Color Temp. (absolute color temperature)	5000 to 10000 °K (Kelvin)	Sets the color tone based on color temperature
Color Adjustment	Slider bars for each color	Adjusts the intensity of individual hues in the image

Setting	Options	Description
Auto Iris	On Off	Adjusts the projected luminance based on the image brightness when certain Color Modes are selected

Note: The **Brightness** setting does not affect lamp brightness. To change the lamp brightness mode, use the **Power Consumption** setting.

Parent topic: [Adjusting the Menu Settings](#)

Related references

[Available Color Modes](#)

Input Signal Settings - Signal Menu

Normally the projector detects and optimizes the input signal settings automatically. If you need to customize the settings, you can use the Signal menu. The available settings depend on the currently selected input source.

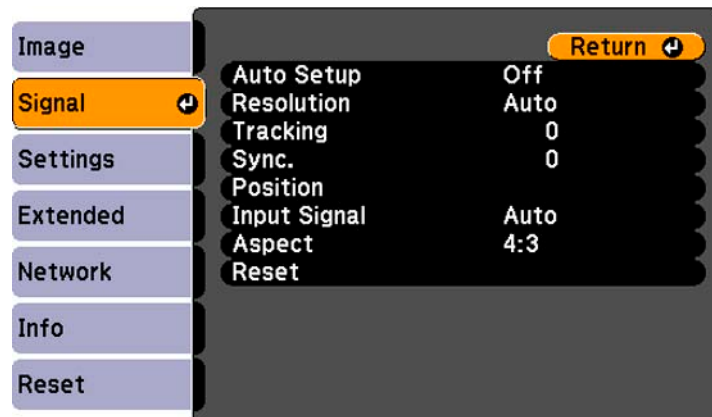

Note: You can restore the default settings of the **Position**, **Tracking**, and **Sync** settings by pressing the **Auto** button on the remote control.

To change settings for an input source, make sure the source is connected and select that source.

Setting	Options	Description
Auto Setup	On Off	Automatically optimizes computer image quality (when On)
Resolution	Auto Normal Wide	Sets the input signal resolution if not detected automatically using the Auto option
Tracking	Varying levels available	Adjusts signal to eliminate vertical stripes in computer images
Sync.	Varying levels available	Adjusts signal to eliminate fuzziness or flickering in computer images
Position	Up, down, left, right	Adjusts the image location on the screen
Progressive	Off Video Film/Auto	Sets whether to convert interlaced-to-progressive signals for certain video image types Off: for fast-moving video images Video: for most video images Film/Auto: for movies, computer graphics, and animation
Noise Reduction	Off NR1 NR2	Reduces flickering in analog images in two levels
HDMI Video Range	Normal Expanded Auto	Sets the video range to match the setting of the device connected to the HDMI input port

Setting	Options	Description
Input Signal	Auto RGB Component	Specifies the signal type from input sources connected to computer ports Auto: detects signals automatically RGB: corrects color for computer/RGB video inputs Component: corrects color for component video inputs
Video Signal	Auto Various video standards	Specifies the signal type from the input sources connected to the video ports Auto: detects signals automatically
Aspect	See the list of available aspect ratios	Sets the aspect ratio (width-to-height ratio) for the selected input source
Overscan	Auto Off 4% 8%	Changes the projected image ratio to make the edges visible by a selectable percentage or automatically

Parent topic: [Adjusting the Menu Settings](#)

Related references

[Available Image Aspect Ratios](#)

Projector Feature Settings - Settings Menu

Options on the Settings menu let you customize various projector features.

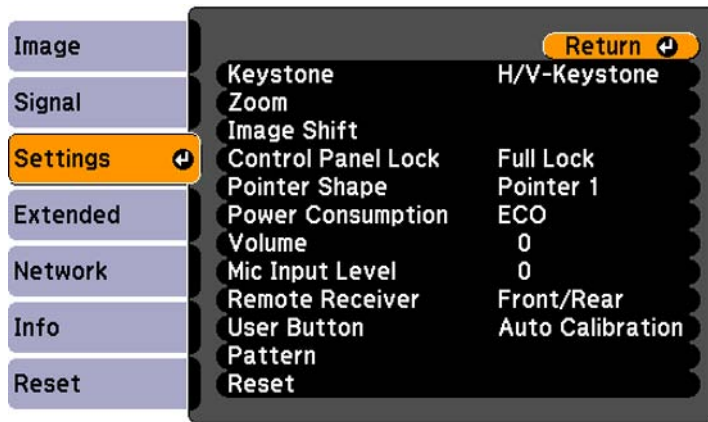

Setting	Options	Description
Keystone	H/V Keystone Quick Corner	Adjusts image shape to rectangular (horizontally and vertically) H/V Keystone: lets you manually correct horizontal and vertical sides Quick Corner: select to correct image shape and alignment using an on-screen display
Zoom	Varying levels available	Adjusts the size of the projected image
Image Shift	Varying positions available	Adjusts the position of the projected image
Control Panel Lock	Full Lock Partial Lock Off	Controls projector button locking to secure the projector Full Lock: locks all buttons Partial Lock: locks all buttons except the power button Off: no buttons locked

Setting	Options	Description
Pointer Shape	Three shapes available	Changes the shape of the remote control pointer feature
Power Consumption	Normal ECO	Selects the brightness mode of the projector lamp Normal: sets maximum lamp brightness ECO: reduces lamp brightness and fan noise, and saves power and lamp life
Volume	Varying levels available	Adjusts the volume of projector's speaker system or external speakers
Mic Input Level	Varying levels available	Adjusts the volume of the projector's speaker system when you use a connected microphone
Remote Receiver	Front Rear Front/Rear Off	Limits reception of remote control signals by the selected receiver; Off turns off all receivers
User Button	Power Consumption Info Progressive Closed Caption Test Pattern Resolution Mic Input Level Pattern Display Auto Calibration	Assigns a menu option to the User button on the remote control for one-touch access

Setting	Options	Description
Pattern	Pattern Display Pattern Type User Pattern Test Pattern	Selects various pattern display options Pattern Display: lets you display the selected pattern type on the screen to aid in presentation Pattern Type: selects the type of grid or line pattern to display User Pattern: captures a projected screen and saves it as a pattern for display Test Pattern: displays a test pattern to assist in focusing and zooming the image and correcting image shape

Parent topic: [Adjusting the Menu Settings](#)

Projector Setup Settings - Extended Menu

Settings on the Extended menu let you customize various projector setup features that control its operation.



Setting	Options	Description
Display	Messages Display Background Startup Screen A/V Mute	Selects various display options Messages: controls whether messages are displayed on the screen Display Background: selects the screen color or logo to display when no signal is received Startup Screen: controls whether a special screen appears when the projector starts up A/V Mute: selects the screen color or logo to display when A/V Mute is turned on
Closed Caption	Off CC1 CC2	Controls use of closed captions and selects the closed caption channel
User's Logo	–	Creates a screen that the projector displays to identify itself and enhance security
Projection	Front Front/Upside Down Rear Rear Upside Down	Selects the way the projector faces the screen so the image is oriented correctly (rear settings cannot be used with the interactive pens)

Setting	Options	Description
Operation	Direct Power On Sleep Mode Sleep Mode Timer High Altitude Mode Audio Input	Selects various operation options Direct Power On: lets you turn on the projector without pressing the power button Sleep Mode: automatically turns off the projector after an interval of inactivity Sleep Mode Timer: sets the interval for Sleep Mode High Altitude Mode: regulates the projector's operating temperature at altitudes above 4921 feet (1500 m) Audio Input: specifies the audio input source if not detected automatically using the Auto option
Standby Setup	Standby Mode Standby Microphone Standby Audio	Selects the following when the projector is in standby mode (turned off): Standby Mode: Communication On lets you monitor the projector over a network and display output signals on an external monitor Standby Microphone: the On setting lets you output audio from a connected microphone Standby Audio: the On setting lets you output audio from a connected source

Setting	Options	Description
USB Type B	Easy Interactive Function USB Display/Easy Interactive Function Wireless Mouse/USB Display	<p>Selects what happens when you connect your computer to the projector's USB-B port</p> <p>Easy Interactive Function lets you use the interactive pens with your computer</p> <p>USB Display/Easy Interactive Function lets you display your computer's image through the USB port and use the interactive pens with your computer (not recommended)</p> <p>Wireless Mouse/USB Display lets you use the wireless mouse feature and display your computer's image through the USB port (interactivity not available)</p>

Setting	Options	Description
Easy Interactive Function	Auto Calibration Manual Calibration Use Source Number of Pen Users Pen Operation Mode Enable Right Click Advanced	Selects various options related to interactive pen operation The two Calibration options start auto or manual calibration Use Source lets you select the image source for interactivity (using Easy Interactive Tools) Number of Pen Users lets you specify One User (for compatibility with Windows Tablet PC and Ink features) or Two Users Pen Operation Mode lets you select Mouse or Pen mode when one pen user is selected Enable Right Click lets you use a long pen press as a right click when mouse mode is selected Advanced lets you assign Right Click or Left Click to the Pen Tip Button and select either Auto Adjust Pen Area or Manual Adj. Pen Area
Language	Various languages available	Selects the language for projector menu and message displays (not changed by Reset option)

Parent topic: [Adjusting the Menu Settings](#)

Projector Network Settings - Network Menu

Settings on the Network menu let you view network information and set up the projector for monitoring and control over a network.

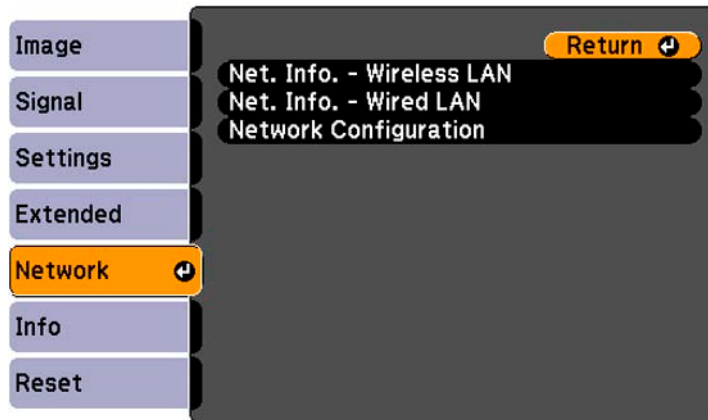

Setting	Options	Description
Net. Info - Wireless LAN	Connection mode Antenna level Projector Name SSID DHCP IP Address Subnet Mask Gateway Address MAC Address Region Code	Displays wireless network status and details
Net. Info - Wired LAN	Projector Name DHCP IP Address Subnet Mask Gateway Address MAC Address	Displays wired network status and details

Setting	Options	Description
Network Configuration	Accesses additional network menus	Configures your network settings

Parent topic: [Adjusting the Menu Settings](#)

Projector Information Display - Info Menu

You can display information about the projector and input sources by viewing the Info menu. However, you cannot change any settings in the menu.

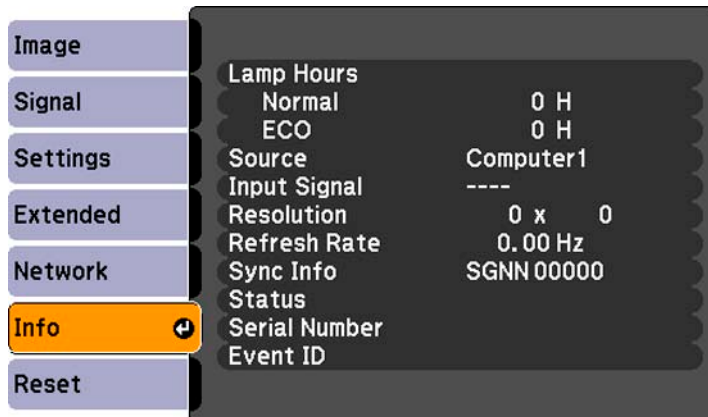

Note: Available settings depend on the current input source. The lamp usage timer does not register any hours until you have used the lamp for at least 10 hours.

Information item	Description
Lamp Hours	Displays the number of hours (H) the lamp has been used in Normal and ECO Power Consumption modes; if the information is displayed in yellow, obtain a genuine Epson replacement lamp soon
Source	Displays the name of the port to which the current input source is connected
Input Signal	Displays the input signal setting of the current input source

Information item	Description
Resolution	Displays the resolution of the current input source
Video Signal	Displays the video signal format of the current input source
Refresh Rate	Displays the refresh rate of the current input source
Sync Info	Displays information that may be needed by a service technician
Status	Displays information about projector problems that may be needed by a service technician
Serial Number	Displays the projector's serial number
Event ID	Displays the Event ID number corresponding to a specific projector problem; see the list of Event ID codes

[Event ID Code List](#)

Parent topic: [Adjusting the Menu Settings](#)

Related references

[Optional Equipment and Replacement Parts](#)

[Projector Lamp Specifications](#)

Event ID Code List

If the **Event ID** option on the Info menu displays a code number, check this list of Event ID codes for the solution to the projector problem associated with the code.

Event ID code	Cause and solution
0432	The EasyMP Network Projection program did not start. Turn the projector off and then on again.
0435	
0434	Unstable network communication. Check the network communication status, wait a few moments, and try connecting to the network again.
0482	
0484	
0485	
0433	Cannot display the transferred images. Restart the EasyMP Network Projection program.

Event ID code	Cause and solution
0481	Communication with computer was disconnected. Restart the EasyMP Network Projection program.
0483	The EasyMP Network Projection program quit unexpectedly. Check the network communication status, then turn the projector off and then on again.
04FE	
0479	A projector system error has occurred. Turn the projector off and then on again.
04FF	
0891	Cannot find an access point with the same SSID. Set your computer, access point, and projector to the same SSID.
0892	The WPA/WPA2 authentication type does not match. Make sure the wireless network security settings are correct.
0893	The WEP/TKIP/AES encryption type does not match. Make sure the wireless network security settings are correct.
0894	Communication with unauthorized access point was disconnected. Contact your network administrator.
0898	Failed to acquire DHCP. Make sure the DHCP server is operating correctly. If you are not using DHCP, turn off the DHCP setting in the Network menus.
0899	A communication error has occurred. Try restarting the EasyMP Network Projection program and restarting your projector. If that does not solve the problem, contact Epson for help.

Parent topic: [Projector Information Display - Info Menu](#)

Projector Reset Options - Reset Menu

You can reset most of the projector settings to their default values using the **Reset All** option on the Reset menu.

You can also reset the projector's lamp usage timer to zero when you replace the lamp using the **Reset Lamp Hours** option.

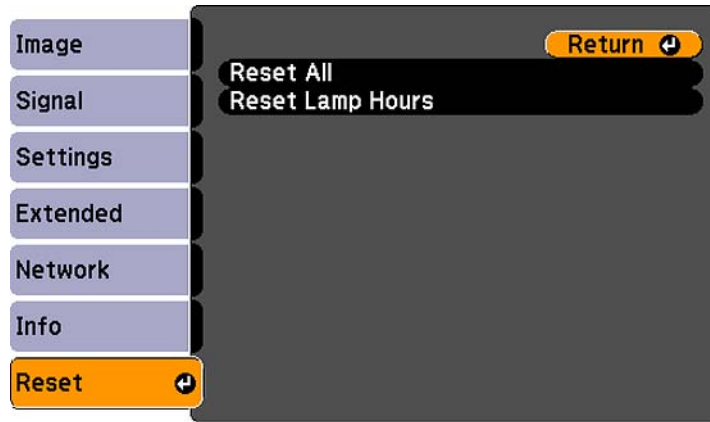

You cannot reset the following settings using the **Reset All** option:

- Input Signal
- User's Logo
- Language
- Network menu items
- Lamp Hours
- Password
- Zoom
- Image Shift

Parent topic: [Adjusting the Menu Settings](#)

Maintaining and Transporting the Projector

Follow the instructions in these sections to maintain your projector and transport it from place to place.

[Projector Maintenance](#)

[Transporting the Projector](#)

Projector Maintenance

Your projector needs little maintenance to keep working at its best.

You may need to clean the projection window and obstacle sensor periodically, and clean the air filter and air vents to prevent the projector from overheating due to blocked ventilation.

The only parts you should replace are the lamp, air filter, and remote control batteries. If any other part needs replacing, contact Epson or an authorized EPSON servicer.

Warning: Before cleaning any part of the projector, turn it off and unplug the power cord. Never open any cover on the projector, except as specifically explained in this manual. Dangerous electrical voltages in the projector can injure you severely.

Warning: Do not try to service this product yourself, except as specifically explained in this manual. Refer all other servicing to qualified servicers.

[Cleaning the Projection Window](#)

[Cleaning the Obstacle Sensor](#)

[Cleaning the Projector Case](#)

[Air Filter and Vent Maintenance](#)

[Projector Lamp Maintenance](#)

[Replacing the Remote Control Batteries](#)

[Replacing the Pen Batteries](#)

[Replacing the Pen Tips](#)

Parent topic: [Maintaining and Transporting the Projector](#)

Cleaning the Projection Window

Clean the projection window periodically, or whenever you notice dust or smudges on the surface.

- To remove dust or smudges, gently wipe the projection window with lens-cleaning paper.

- To remove stubborn smudges, moisten a soft, lint-free cloth with lens cleaner and gently wipe the projection window.

Warning: Do not use a lens cleaner that contains flammable gas. The high heat generated by the projector lamp may cause a fire.

Caution: Do not use canned air, or the gases may leave a residue.

Parent topic: [Projector Maintenance](#)

Cleaning the Obstacle Sensor

Clean the projector's obstacle sensor glass (circled in red) periodically, or if you see a message telling you to remove any obstacles that are interfering with the projection area.

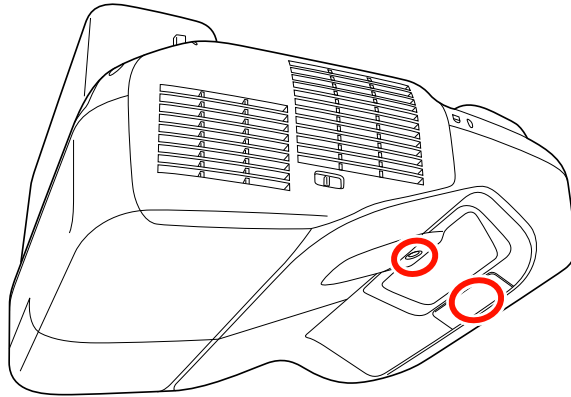

- To remove dust or smudges, gently wipe the obstacle sensor glass with lens-cleaning paper.
- To remove stubborn smudges, moisten a soft, lint-free cloth with lens cleaner and gently wipe the obstacle sensor glass.

Warning: Do not use a lens cleaner that contains flammable gas. The high heat generated by the projector lamp may cause a fire.

Caution: Do not use canned air, or the gases may leave a residue.

Parent topic: [Projector Maintenance](#)

Cleaning the Projector Case

Before cleaning the projector case, turn off the projector and unplug the power cord.

- To remove dust or dirt, use a soft, dry, lint-free cloth.
- To remove stubborn dirt, use a soft cloth moistened with water and mild soap. Do not spray liquid directly on the projector.

Caution: Do not use wax, alcohol, benzene, paint thinner, or other chemicals to clean the projector case. These can damage the case. Do not use canned air, or the gases may leave a residue.

Parent topic: [Projector Maintenance](#)

Air Filter and Vent Maintenance

The projector's air filter keeps the intake air clean. If dust collects on the air filter or vents, clean them as described in this manual. Dust clogs may cause the projector to overheat due to improper ventilation.

Be sure to clean the air filter and vents if you see a message telling you to do so. Also make sure nothing blocks the vents.

[Cleaning the Air Filter and Vents](#)

[Replacing the Air Filter](#)

Parent topic: [Projector Maintenance](#)

Cleaning the Air Filter and Vents

Clean the projector's air filter or vents if they get dusty, or if you see a message telling you to clean them.

1. Turn off the projector and unplug the power cord.

2. Gently remove the dust using a small vacuum designed for computers or a very soft brush (such as a paintbrush).

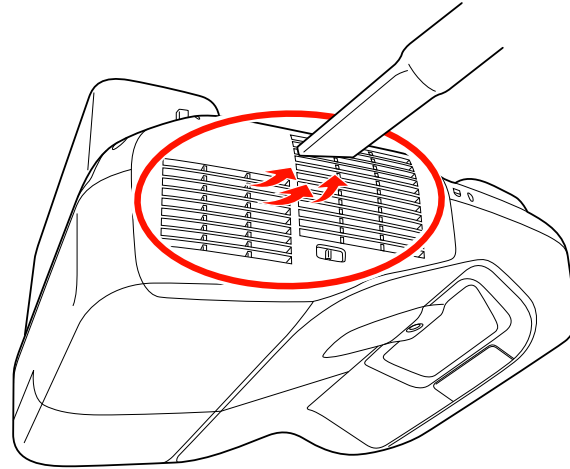

Note: You can remove the air filter so you can clean both sides of it. Do not rinse the air filter in water, or use any detergent or solvent to clean it.

Caution: Do not use canned air, or the gases may leave a residue.

3. If dust is difficult to remove or the air filter is damaged, replace the air filter.

Parent topic: [Air Filter and Vent Maintenance](#)

Replacing the Air Filter

You need to replace the air filter in the following situations:

- After cleaning the air filter, you see a message telling you to clean or replace it
- The air filter is torn or damaged

You can replace the air filter while the projector is mounted on the wall or ceiling.

1. Turn off the projector and unplug the power cord.

2. Slide the air filter cover switch and open the air filter cover.

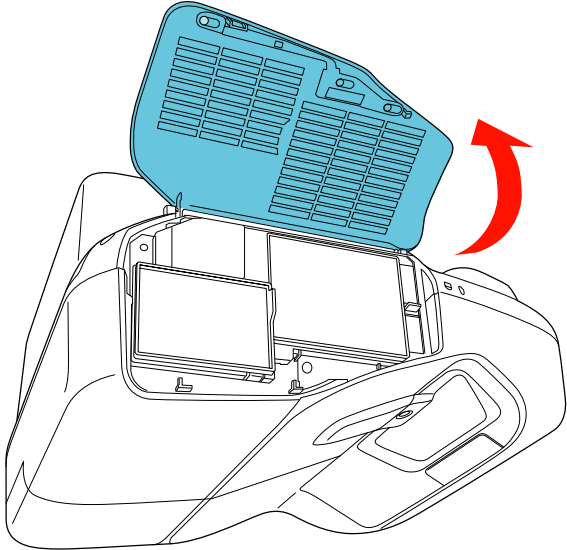
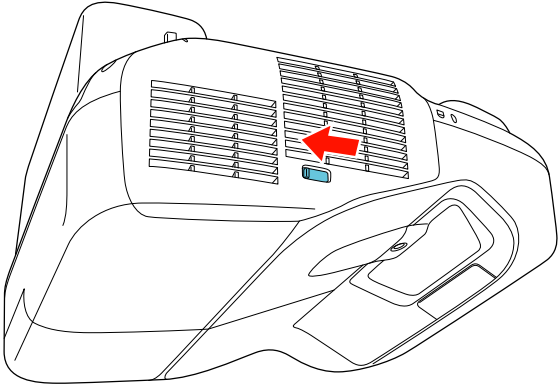

3. Pull the air filter out of the projector.

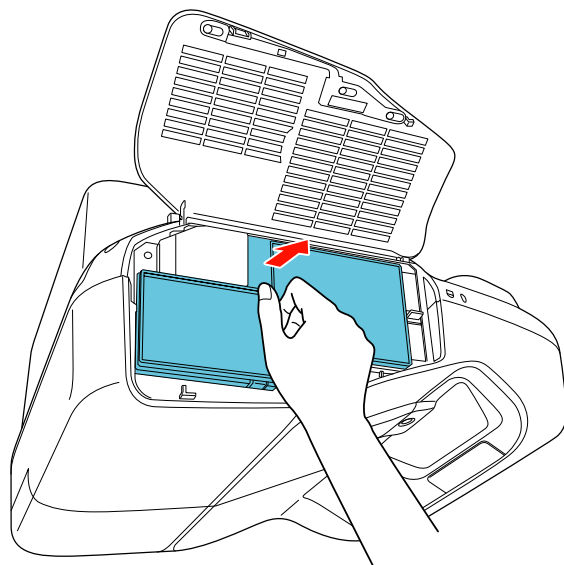

Note: Air filters contain polypropylene. Dispose of used air filters according to local regulations.

4. Place the new air filter in the projector as shown.

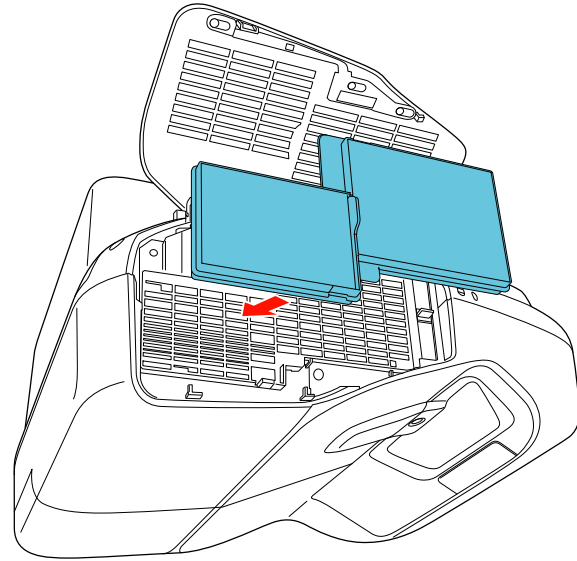

5. Close the air filter cover.

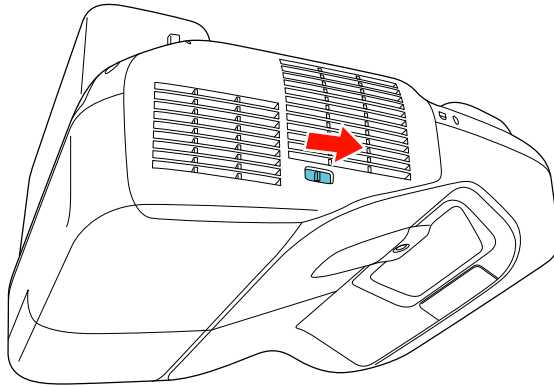
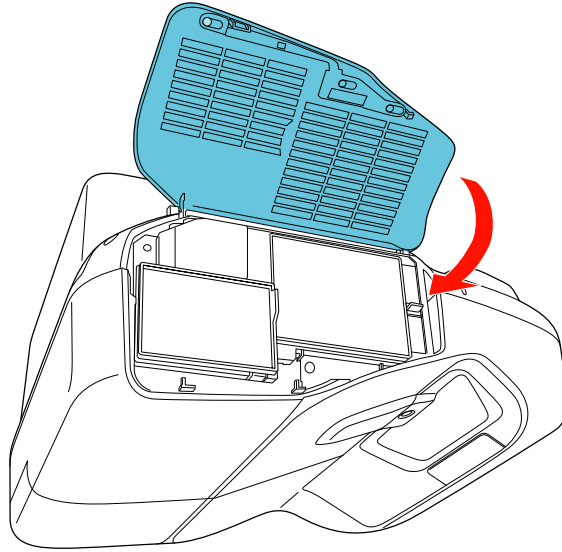

Parent topic: [Air Filter and Vent Maintenance](#)

Projector Lamp Maintenance

The projector keeps track of the number of hours the lamp is used and displays this information in the projector's menu system.

Replace the lamp as soon as possible when the following occurs:

- The projected image gets darker or starts to deteriorate
- A message appears when you turn on the projector telling you to replace the lamp
- The projector's lamp light is flashing orange

[Replacing the Lamp](#)

[Resetting the Lamp Timer](#)

Parent topic: [Projector Maintenance](#)

Related references

[Projector Setup Settings - Extended Menu](#)

[Projector Lamp Specifications](#)

[Projector Information Display - Info Menu](#)

Replacing the Lamp

Before you replace the lamp, let the projector cool down for at least one hour so the lamp will not be hot.

Warning: Let the lamp fully cool before replacing it to avoid injury.

You can replace the lamp while the projector is mounted on the wall or ceiling.

1. Turn off the projector and unplug the power cord.
2. Allow the projector lamp to cool down for at least one hour.

Warning: If the lamp is broken, glass fragments may be loose inside the lamp chamber. Be careful removing any broken glass to avoid injury. If the projector is mounted on the wall or ceiling, stand to the side in case the lamp is broken.

3. Use the screwdriver included with the replacement lamp to loosen the screw securing the lamp cover.

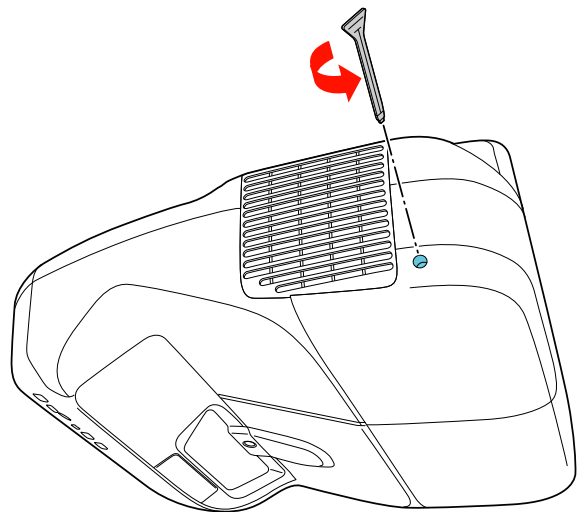

4. Slide off the lamp cover.

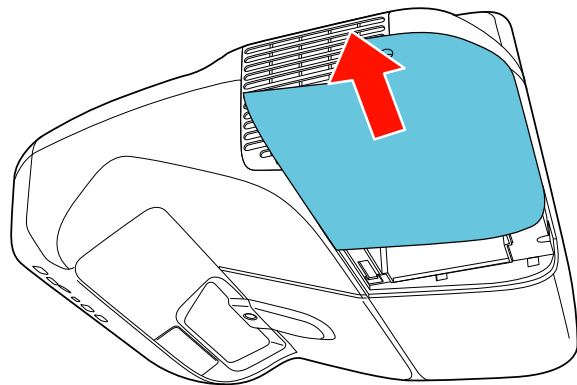

5. Loosen the screws securing the lamp to the projector. The screws do not come all the way out.

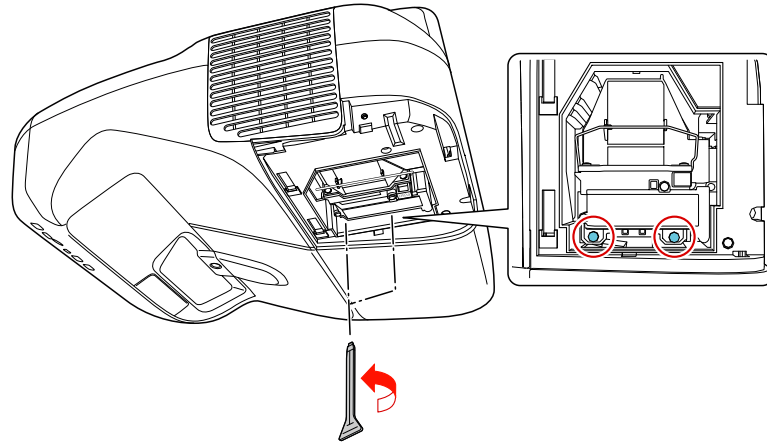

6. Lift up the lamp handle and gently pull the lamp out of the projector.

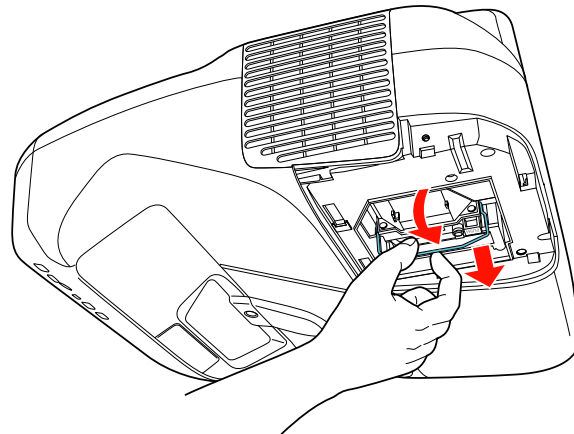

Note: (Hg) The lamp(s) in this product contain mercury. Please consult your state and local regulations regarding disposal or recycling. Do not put in the trash.

7. Gently insert the new lamp into the projector along the guide rail. If it does not fit easily, make sure it is facing the right way. Press the handle down.

Caution: Do not touch any glass on the lamp assembly to avoid premature lamp failure.

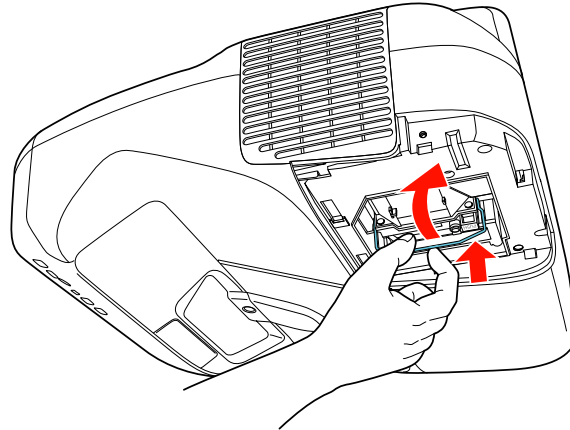

8. Tighten the screws to secure the lamp.

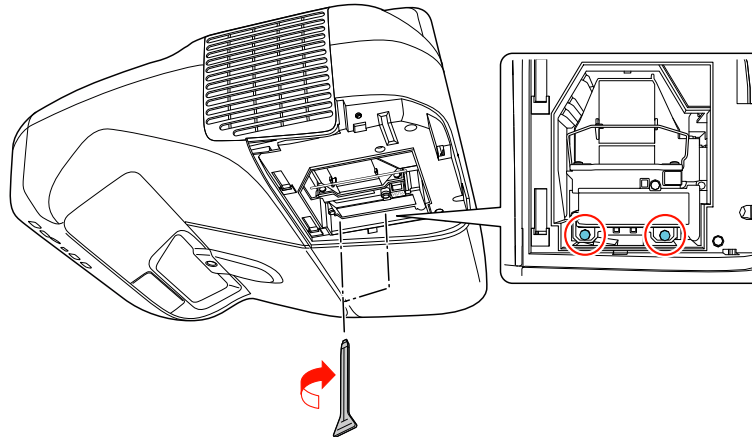

9. Replace the lamp cover and tighten the screw to secure it.

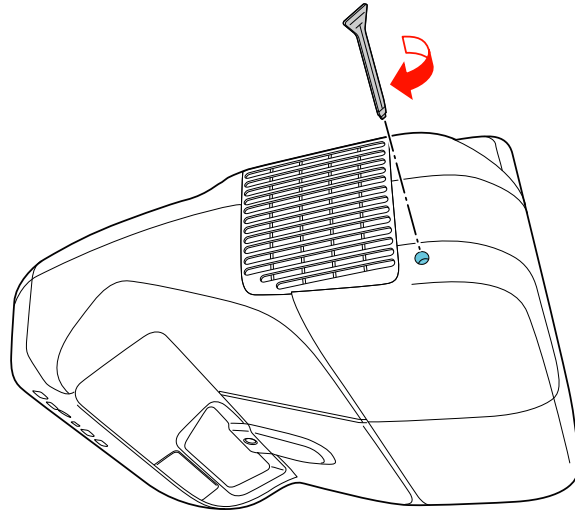

Note: Be sure the lamp cover is securely installed or the lamp will not come on.

Reset the lamp timer to zero to keep track of the new lamp's usage.

Parent topic: [Projector Lamp Maintenance](#)

Related tasks

[Resetting the Lamp Timer](#)

Resetting the Lamp Timer

You must reset the lamp timer after replacing the projector's lamp to clear the lamp replacement message and to keep track of lamp usage correctly.

Note: Do not reset the lamp timer if you have not replaced the lamp to avoid inaccurate lamp usage information.

1. Turn on the projector.
2. Press the **Menu** button.

3. Select the **Reset** menu and press **Enter**.

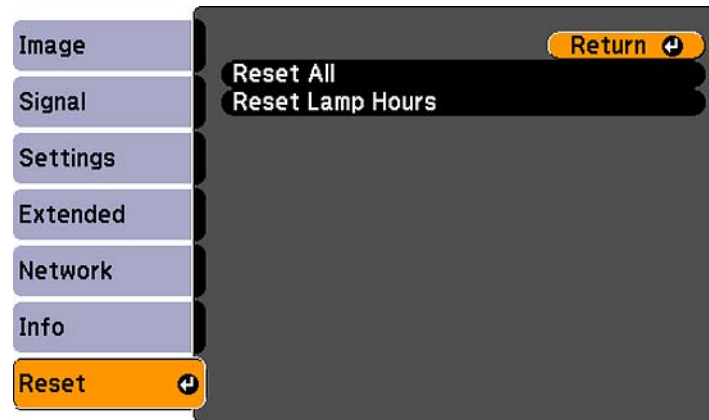

4. Select **Reset Lamp Hours** and press **Enter**.
You see a prompt asking if you want to reset the lamp hours.
5. Select **Yes** and press **Enter**.
6. Press **Menu** or **Esc** to exit the menus.

Parent topic: [Projector Lamp Maintenance](#)

Related tasks

[Replacing the Lamp](#)

Replacing the Remote Control Batteries

The remote control uses two AA manganese or alkaline batteries. Replace the batteries as soon as they run out.

Caution: Use only the type of batteries specified in this manual. Do not install batteries of different types, or mix new and old batteries.

1. Open the battery cover as shown.

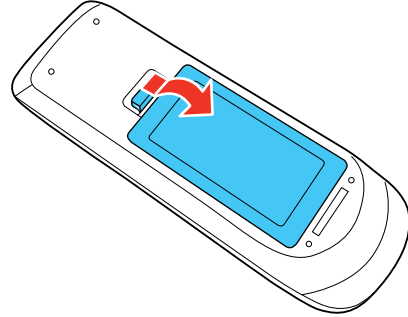

2. Remove the old batteries.

Warning: If the battery fluid has leaked, wipe it away with a soft cloth and avoid getting the fluid on your hands. If it gets on your hands, wash them immediately to avoid injury.

3. Insert the batteries with the + and – ends facing as shown.

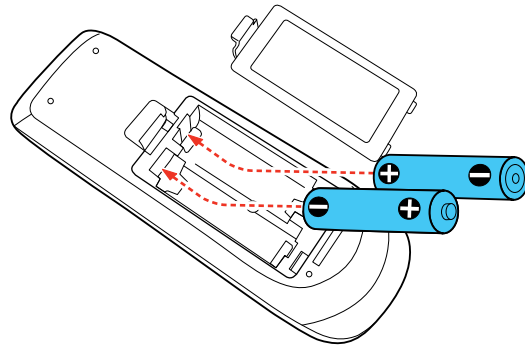

4. Close the battery cover and press it down until it clicks into place.

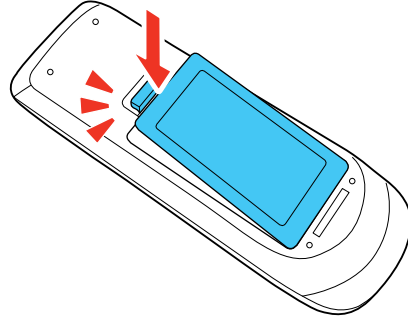

Warning: Dispose of used batteries according to local regulations. Do not expose batteries to heat or flame. Keep batteries out of the reach of children; they are choking hazards and are very dangerous if swallowed.

Parent topic: [Projector Maintenance](#)

Related references

[Remote Control Operation](#)

Replacing the Pen Batteries

Each pen uses one AA alkaline or Sanyo Eneloop rechargeable battery. Replace the battery as soon as it runs out.

When the battery is low, the pen light flashes as you turn on the switch. When the battery runs out, the pen light goes out.

Caution: Use only the type of batteries specified in this manual.

1. Open the battery cover as shown.

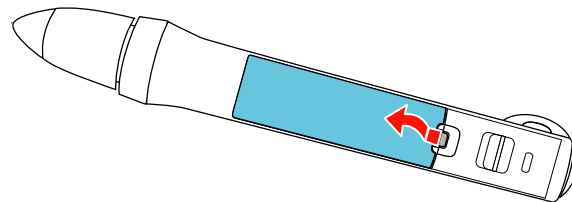

2. Remove the old battery.

Warning: If the battery fluid has leaked, wipe it away with a soft cloth and avoid getting the fluid on your hands. If it gets on your hands, wash them immediately to avoid injury.

3. Insert the battery with the + and – ends facing as shown.

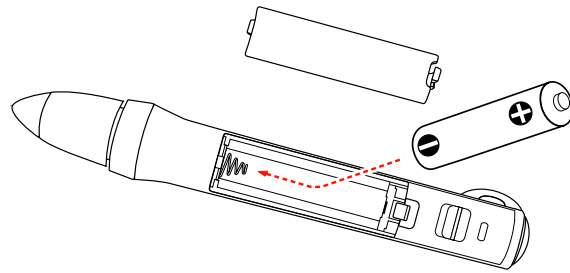

4. Replace the battery cover and press it down until it clicks into place.

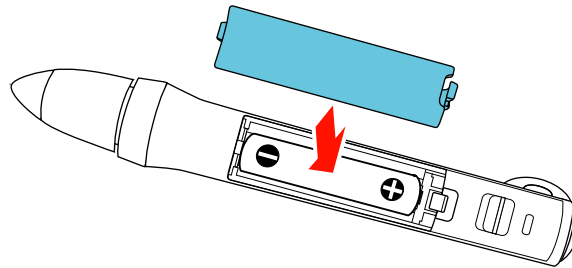

Warning: Dispose of used batteries according to local regulations. Do not expose batteries to heat or flame. Keep batteries out of the reach of children; they are choking hazards and are very dangerous if swallowed.

Parent topic: [Projector Maintenance](#)

Replacing the Pen Tips

If the pen tips become damaged or no longer work correctly, you can replace them.

1. Twist off the tip of the pen to remove it.

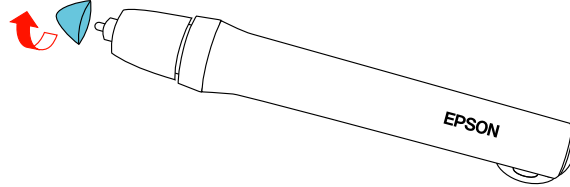

2. Twist on the new tip.

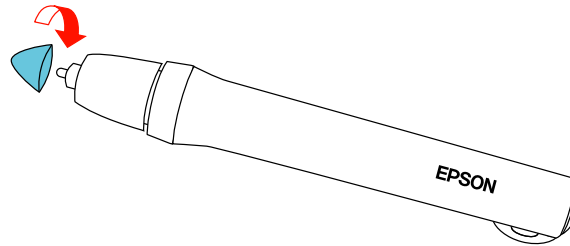

Parent topic: [Projector Maintenance](#)

Related references

[Optional Equipment and Replacement Parts](#)

Transporting the Projector

The projector contains precision parts, some of which are glass. Follow these guidelines to transport or ship the projector safely:

- Remove any equipment connected to the projector.
- When transporting the projector a long distance or as checked luggage, pack it in a firm box with cushioning around it and mark the box "Fragile."
- When shipping the projector for repairs, place it in its original packing materials, if possible, or use equivalent materials with cushioning around the projector. Mark the box "Fragile."

Note: Epson shall not be liable for any damages incurred during transportation.

Parent topic: [Maintaining and Transporting the Projector](#)

Solving Problems

Check the solutions in these sections if you have any problems using the projector.

[Projection Problem Tips](#)

[Projector Light Status](#)

[Using the Projector Help Displays](#)

[Solving Image or Sound Problems](#)

[Solving Projector or Remote Control Operation Problems](#)

[Solving Interactive Pen Problems](#)

[Solutions When Network Alert E-Mails are Not Received](#)

[Where to Get Help](#)

Projection Problem Tips

If the projector is not working properly, try turning it off and unplugging it. Then plug it back in and turn it on.

If this does not solve the problem, check the following:

- The lights on the projector may indicate what the problem is.
- The projector's Help system can display information about common problems, if the projector is operating.
- The solutions in this manual can help you solve many problems.

If none of these solutions help, you can contact Epson for technical support.

Parent topic: [Solving Problems](#)

Projector Light Status

The lights on the projector's control panel indicate the projector status and let you know when a problem occurs. Check the status and color of the lights and look for a solution in the table below.

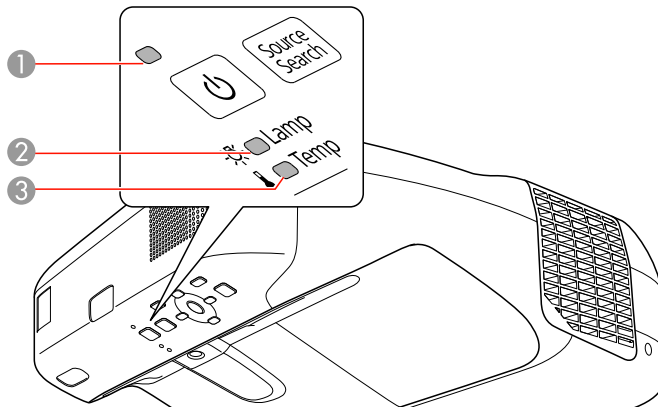

- 1 Power light
- 2 Lamp light
- 3 Temperature light

Power light	Lamp light	Temperature light	Status and solution
Green	Off	Off	Normal operation.
Flashing green	Off	Off	Warming up. Wait for an image to appear.
Orange	Off	Off	Standby or sleep mode.
Flashing orange	Off	Off	Preparing network monitoring or shutting down. (Wait for the light to remain orange before unplugging the projector.)
Flashing red	Off	Flashing orange	Projector is too hot. <ul style="list-style-type: none"> • Make sure that the vents and air filter are not clogged with dust or obstructed by nearby objects. • Make sure the environmental temperature is not too hot. • If overheating continues, replace the air filter.

Power light	Lamp light	Temperature light	Status and solution
Red	Off	Red	<p>Projector has overheated and turned off. Leave it turned off to cool down for five minutes.</p> <ul style="list-style-type: none"> • Make sure that the vents and air filter are not clogged with dust or obstructed by nearby objects. • If operating the projector at high altitude, turn on High Altitude Mode. • If overheating continues, replace the air filter. • If the problem persists, unplug the projector and contact Epson for help.
Red	Flashing red	Off	<p>Lamp has a problem.</p> <ul style="list-style-type: none"> • Check to see if the lamp is burned out, broken, or installed incorrectly. Reseat or replace the lamp as necessary. • Make sure that the vents and air filter are not clogged with dust or obstructed by nearby objects. • If operating the projector at high altitude, turn on High Altitude Mode. • If the problem persists, unplug the projector and contact Epson for help.
Varies	Flashing orange	Off	<p>Replace the lamp soon to avoid damage. Do not continue using the projector.</p>
Red	Off	Flashing red	<p>A fan or sensor has a problem. Turn the projector off, unplug it, and contact Epson for help.</p>
Varies	Flashing orange	Flashing orange	<p>An obstacle has been detected around the projection window. Remove the obstacle, or clean the obstacle sensors. If the problem persists, unplug the projector and contact Epson for help.</p>
Red or flashing red	Flashing red	Flashing red	<p>Internal projector error. Turn the projector off, unplug it, and contact Epson for help.</p>

Note: If the lights display a pattern not listed in the table above, turn the projector off, unplug it, and contact Epson for help.

Parent topic: [Solving Problems](#)

Related references

[Projector Feature Settings - Settings Menu](#)

[Projector Setup Settings - Extended Menu](#)

[Where to Get Help](#)

Related tasks

[Cleaning the Air Filter and Vents](#)

[Replacing the Air Filter](#)

[Replacing the Lamp](#)

Using the Projector Help Displays

You can display information to help you solve common problems using the projector's Help system.

1. Turn on the projector.
2. Press the **Help** button on the projector or the remote control.
You see the Help menu.
3. Use the up and down arrow buttons to highlight the problem you want to solve.
4. Press **Enter** to view the solutions.
5. When you are finished, do one of the following:
 - To select another problem to solve, press **Esc**.
 - To exit the help system, press **Help**.

Parent topic: [Solving Problems](#)

Solving Image or Sound Problems

Check the solutions in these sections if you have any problems with projected images or sound.

[Solutions When No Image Appears](#)

[Solutions When Image is Incorrect Using the USB Display Function](#)

[Solutions When "No Signal" Message Appears](#)

[Solutions When "Not Supported" Message Appears](#)

[Solutions When Only a Partial Image Appears](#)

[Solutions When the Image is Not Rectangular](#)

[Solutions When the Image Contains Noise or Static](#)

[Solutions When the Image is Fuzzy or Blurry](#)

[Solutions When the Image Brightness or Colors are Incorrect](#)

[Solutions When There is No Sound or Low Volume](#)

[Solutions to Microphone Problems](#)

Parent topic: [Solving Problems](#)

Solutions When No Image Appears

If no image appears, try the following solutions:

- Press the **A/V Mute** button on the remote control to see if the image was temporarily turned off.
- Make sure all necessary cables are securely connected and the power is on for the projector and connected video sources.
- Press the projector's power button to wake it from standby or sleep mode. Also see if your connected computer is in sleep mode or displaying a blank screen saver.
- Check the settings on the Signal menu to make sure they are correct for the current video source.
- Adjust the **Brightness** setting or select the **Normal** Power Consumption setting.
- Check the **Display** setting to make sure **Messages** is set to **On**.
- If the projector does not respond when you press the control panel buttons, the buttons may be locked. Unlock the buttons.
- If the projector does not respond when you press buttons on the remote control, make sure the remote receivers are turned on.
- For images projected with Windows Media Center, reduce the screen size from full screen mode.
- For images projected from applications using Windows DirectX, turn off DirectX functions.

Parent topic: [Solving Image or Sound Problems](#)

Related references

[Projector Setup Settings - Extended Menu](#)

[Projector Feature Settings - Settings Menu](#)

[Input Signal Settings - Signal Menu](#)

[Image Quality Settings - Image Menu](#)

Related tasks

[Unlocking the Projector's Buttons](#)

Solutions When Image is Incorrect Using the USB Display Function

If no image appears or if the image appears incorrectly using the USB Display function, try the following solutions:

- Press the **USB** button on the remote control.
- Make sure the USB Display software has installed correctly. Install it manually if necessary.
- Make sure the **USB Type B** setting in the Extended menu is set to one of the **USB Display** options.
- With Mac OS X, select the **USB Display** icon in the Dock or from the **Applications** folder.
- With Windows Media Center, reduce the screen size from full screen mode.
- With Windows DirectX, turn off DirectX functions.
- If the mouse cursor flickers, select **Make the movement of the mouse pointer smooth** in the EPSON USB Display Settings program on your computer.
- Turn off the **Transfer layered window** setting in the EPSON USB Display Settings program on your computer.

Parent topic: [Solving Image or Sound Problems](#)

Solutions When "No Signal" Message Appears

If the "No Signal" message appears, try the following solutions:

- Press the **Source Search** button and wait a few seconds for an image to appear.
- Turn on the connected computer or video source, and press its play button to begin your presentation, if necessary.
- Check the connection from the projector to your video sources.
- If you are projecting from a laptop computer, make sure it is set up to display on an external monitor.
- If necessary, turn the projector and the connected computer or video source off and then on again.

[Displaying From a PC Laptop](#)

[Displaying From a Mac Laptop](#)

Parent topic: [Solving Image or Sound Problems](#)

Displaying From a PC Laptop

If you see the "No Signal" message when you display from a PC laptop, you need to set up the laptop to display on an external monitor.

1. Hold down the laptop's **Fn** key and press the key labelled with a monitor icon or **CRT/LCD**. (See your laptop manual for details.) Wait a few seconds for an image to appear.
2. To display on both the laptop's monitor and the projector, try pressing the same keys again.
3. If the same image is not displayed by the laptop and projector, check the Windows **Display** utility to make sure the external monitor port is enabled. (See your computer or Windows manual for instructions.)
4. If necessary, check your video card settings and set the multiple display option to **Clone**.

Parent topic: [Solutions When "No Signal" Message Appears](#)

Related tasks

[Using the Projector Help Displays](#)

Displaying From a Mac Laptop

If you see the "No Signal" message when you display from a Mac laptop, you need to set up the laptop for mirrored display. (See your laptop manual for details.)

1. Open the **System Preferences** utility and select **Displays**.
2. Select the **VGA Display** or **Color LCD** option, if necessary.
3. Click the **Arrange** or **Arrangement** tab.
4. Select the **Mirror Displays** checkbox.

Parent topic: [Solutions When "No Signal" Message Appears](#)

Solutions When "Not Supported" Message Appears

If the "Not Supported" message appears, try the following solutions:

- Make sure the correct input signal is selected on the Signal menu.
- Make sure the computer's display resolution does not exceed the projector's resolution and frequency limit. If necessary, select a different display resolution for your computer. (See your computer manual for details.)

Parent topic: [Solving Image or Sound Problems](#)

Related references

[Input Signal Settings - Signal Menu](#)

Solutions When Only a Partial Image Appears

If only a partial computer image appears, try the following solutions:

- Press the **Auto** button on the remote control to optimize the image signal.
- Try adjusting the image position using the **Position** menu setting.
- Press the **Aspect** button on the remote control to select a different image aspect ratio.
- If you zoomed into or out of the image using the **E-Zoom** buttons, press the **Esc** button twice to return to a full display.
- Check your computer display settings to disable dual display and set the resolution within the projector's limits. (See your computer manual for details.)
- Check the resolution assigned to your presentation files to see if they are created for a different resolution than you are projecting in. (See your software help for details.)

Parent topic: [Solving Image or Sound Problems](#)

Related references

[Input Signal Settings - Signal Menu](#)

[Supported Video Display Formats](#)

Solutions When the Image is Not Rectangular

If the projected image is not evenly rectangular, try the following solutions:

- If the projector is not mounted on the wall or ceiling, place it directly in front of the center of the screen, facing it squarely, if possible.
- Use the **Image Shift** setting to adjust the image position, rather than moving the projector.
- If you adjusted the projector height using the projector feet, press the keystone buttons on the projector to adjust the image shape.
- Adjust the **Quick Corner** or **Keystone** setting to correct the image shape.

Parent topic: [Solving Image or Sound Problems](#)

Related references

[Projector Feature Settings - Settings Menu](#)

Related tasks

[Correcting Image Shape with Quick Corner](#)

[Correcting Image Shape with the Keystone Buttons](#)
[Adjusting the Image Position](#)

Solutions When the Image Contains Noise or Static

If the projected image seems to contain electronic interference (noise) or static, try the following solutions:

- Check the cables connecting your computer or video source to the projector. They should be:
 - Separated from the power cord to prevent interference
 - Securely connected at both ends
 - Not connected to an extension cable
- Check the settings on the projector's Signal menu to make sure they match the video source.
- Select a computer video resolution that is compatible with the projector.
- If you are projecting from a computer, press the **Auto** button on the remote control to automatically adjust the **Tracking** and **Sync** settings.
- If you adjusted the image shape using the projector controls, try decreasing the **Sharpness** setting to improve image quality.
- If you connected an extension power cable, try projecting without it to see if it caused interference in the signal.

Parent topic: [Solving Image or Sound Problems](#)

Related references

[Input Signal Settings - Signal Menu](#)

[Supported Video Display Formats](#)

Related tasks

[Displaying From a PC Laptop](#)

[Displaying From a Mac Laptop](#)

Solutions When the Image is Fuzzy or Blurry

If the projected image is fuzzy or blurry, try the following solutions:

- Adjust the image focus.
- Position the projector close enough to the screen, and directly in front of it.
- Position the projector so the keystone adjustment angle is not so wide that it distorts the image.

- Adjust the **Sharpness** setting to improve image quality.
- If you are projecting from a computer, press the **Auto** button on the remote control to automatically adjust the tracking and sync. If any bands or overall blurriness remains, display a uniformly patterned image on the screen and manually adjust the **Tracking** and **Sync** settings.

Parent topic: [Solving Image or Sound Problems](#)

Related references

[Input Signal Settings - Signal Menu](#)

[Image Quality Settings - Image Menu](#)

[Projection Distance](#)

Related tasks

[Focusing the Image](#)

[Cleaning the Projection Window](#)

Solutions When the Image Brightness or Colors are Incorrect

If the projected image is too dark or light, or the colors are incorrect, try the following solutions:

- Press the **Color Mode** button on the remote control to try different color modes for the image and environment.
- Adjust the available settings on the Image menu for the current input source, such as **Brightness**, **Contrast**, **Tint**, **Color Adjustment**, and/or **Color Saturation**.
- Make sure you selected the correct input source on the Signal menu.
- Make sure all the cables are securely connected to the projector and your video device. If you connected long cables, try connecting shorter cables.
- If the colors are incorrect from a video source, make sure you selected the correct **Video Signal** setting.
- If you are using the **ECO** Power Consumption setting, try selecting **Normal** in the Settings menu.
- If the image has been progressively darkening, you may need to replace the projector lamp soon.

Parent topic: [Solving Image or Sound Problems](#)

Related concepts

[Projector Lamp Maintenance](#)

Related references

[Input Signal Settings - Signal Menu](#)

[Projector Feature Settings - Settings Menu](#)

Solutions When There is No Sound or Low Volume

If there is no sound when you expect it or the volume is too low, try the following solutions:

- Adjust the projector's volume settings.
- Press the **A/V Mute** button on the remote control to resume video and audio if they were temporarily stopped.
- Press the **Source Search** button to switch to the correct input source, if necessary.
- Check your computer or video source to make sure the volume is turned up and the audio output is set for the correct source.
- Check the audio cable connections between the projector and your video source.
- Make sure any connected audio cables are labelled "No Resistance".
- If you are using a Mac and you do not hear sound from an HDMI source, make sure your Mac supports audio through the HDMI port. If not, you need to connect an audio cable.
- If you want to use a connected audio source when the projector is off, set the **Standby Mode** option to **Communication On** and turn on the **Standby Audio** option.

Parent topic: [Solving Image or Sound Problems](#)

Solutions to Microphone Problems

If there is no sound when you use a microphone connected to the projector, try the following solutions:

- Make sure the microphone is securely connected to the projector.
- Make sure you are using a dynamic microphone, not a condenser microphone.
- Adjust the **Mic Input Level** setting as necessary in the projector's menus.
- If you want to use the microphone when the projector is off, set the **Standby Mode** option to **Communication On** and turn on the **Standby Microphone** option.

Parent topic: [Solving Image or Sound Problems](#)

Related references

[Projector Setup Settings - Extended Menu](#)

[Projector Feature Settings - Settings Menu](#)

Related tasks

[Connecting a Microphone](#)

Solving Projector or Remote Control Operation Problems

Check the solutions in these sections if you have problems operating the projector or remote control.

[Solutions to Projector Power or Shut-Off Problems](#)

[Solutions to Problems with the Remote Control](#)

[Solutions to Password Problems](#)

Parent topic: [Solving Problems](#)

Solutions to Projector Power or Shut-Off Problems

If the projector does not come on when you press the power button or it shuts off unexpectedly, try the following solutions:

- Make sure the power cord is securely connected to the projector and to a working electrical outlet.
- The projector's buttons may be locked for security. Unlock the buttons or use the remote control to turn on the projector.
- The power cord may be defective. Disconnect the cord and contact Epson.
- If the projector's lamp shuts off unexpectedly, it may have entered sleep mode after a period of inactivity. Begin a presentation to wake the projector.
- If the projector's lamp shuts off and the power and **Temp** lights are red, the projector has overheated and shut off. Check the solutions for this light status.
- If the power button on the remote control does not turn on the projector, check its batteries and make sure the **Remote Receivers** setting is turned on in the projector's menus, if available.

Parent topic: [Solving Projector or Remote Control Operation Problems](#)

Related references

[Projector Light Status](#)

[Projector Feature Settings - Settings Menu](#)

Related tasks

[Unlocking the Projector's Buttons](#)

Solutions to Problems with the Remote Control

If the projector does not respond to remote control commands, try the following solutions:

- Check that the remote control batteries are installed correctly and have power. If necessary, replace the batteries.

- Make sure you are operating the remote control within the reception angle and range of the projector.
- Check to see if a button on the remote control is stuck down, causing it to enter sleep mode. Release the button to wake the remote control up.
- Strong fluorescent lighting, direct sunlight, or infrared device signals may be interfering with the projector's remote receivers. Dim the lights or move the projector away from the sun or interfering equipment.
- If available, turn off one of the remote receivers in the projector's menu system, or check if all the remote receivers were turned off.
- If you assigned an ID number to the remote control to operate multiple projectors, you may need to check or change the ID setting (feature not available with all projectors).
- If you lose the remote control, you can order another one from Epson.

Parent topic: [Solving Projector or Remote Control Operation Problems](#)

Related references

[Projector Feature Settings - Settings Menu](#)

[Optional Equipment and Replacement Parts](#)

[Remote Control Operation](#)

Solutions to Password Problems

If you cannot enter or remember a password, try the following solutions:

- You may have turned on password protection without first setting a password. Try entering **0000** using the remote control.
- If you have entered an incorrect password too many times and see a message displaying a request code, write down the code and contact Epson.
- If you lose the remote control you cannot enter a password. Order a new one from Epson.

Parent topic: [Solving Projector or Remote Control Operation Problems](#)

Solving Interactive Pen Problems

Check the solutions in these sections if you have problems using the interactive pens.

[Solutions When "Hardware Device Not Found" Message Appears](#)

[Solutions When "Error Occurred in the Easy Interactive Function" Message Appears](#)

[Solutions When the Interactive Pens Do Not Work](#)

[Solutions When Manual Calibration is Difficult](#)

[Solutions When the Built-In Toolbar Does Not Work](#)

[Solutions When the Interactive Pen Position Is Not Accurate](#)

[Solutions When the Interactive Pens Are Slow or Difficult to Use](#)

[Solutions When the Interactive Pens Cause Interference or Unwanted Effects](#)

Parent topic: [Solving Problems](#)

Solutions When "Hardware Device Not Found" Message Appears

If the "Hardware device not found" message appears, try the following solutions:

- Check the USB cable connection from the projector to your computer. Try disconnecting and then reconnecting the cable.
- If you are projecting from a laptop computer, make sure the battery has enough power, or connect the laptop to a power outlet.
- If your USB cable is installed in the wall, try connecting a different USB cable to the projector and your computer.

Parent topic: [Solving Interactive Pen Problems](#)

Solutions When "Error Occurred in the Easy Interactive Function" Message Appears

If the "Error occurred in the Easy Interactive Function" message appears, contact Epson for help.

Parent topic: [Solving Interactive Pen Problems](#)

Related references

[Where to Get Help](#)

Solutions When the Interactive Pens Do Not Work

If the pens do not work, try the following solutions:

- The pens go into standby mode if you forget to turn them off. Touch the tip of the pen to activate it.
- Make sure you are not covering the black section near the tip of the pen.
- Make sure nothing is blocking the signal between the pen and the interactive pen receiver on the projector.
- Try holding the pen at a different angle so that your hand is not blocking the signal.
- Make sure the cable cover is in place to keep cables from blocking the signal.
- Make sure the pen battery has enough power. Try replacing the battery.

- If you are projecting from a computer, make sure the USB cable is connected to the computer and projector.
- Dim the room lights and turn off any fluorescent lights. Make sure the projection surface and pen receiver are not in direct sunlight or other sources of bright lighting.
- If the pen tip is worn out or damaged, you may need to replace it.
- Make sure the pen receiver on the projector is clean and free from dust.
- Make sure there is no interference from infrared remote controls or infrared microphones.
- Make sure the **USB Type-B** option on the Extended menu is set to **Easy Interactive Function** or **USB Display/Easy Interactive Function**.
- Make sure the **Use Source** option on the Extended menu is set to the correct source.
- Make sure you have calibrated the system. Try recalibrating.

Note: You cannot use both pens at the same time with the built-in toolbar.

Parent topic: [Solving Interactive Pen Problems](#)

Related references

[Projector Setup Settings - Extended Menu](#)

Related tasks

[Using the Pens](#)

[Replacing the Pen Tips](#)

Solutions When Manual Calibration is Difficult

If you are having trouble calibrating manually, try the following solutions:

- If the circle does not move to the next position, or it moves automatically, dim or turn off any bright lights near the projection surface.
- Make sure the projector is not too close to the projection surface.

Parent topic: [Solving Interactive Pen Problems](#)

Solutions When the Built-In Toolbar Does Not Work

If you cannot use the pen without a computer, try the following solutions:

- Make sure the **USB Type-B** option on the Extended menu is set to **Easy Interactive Function** or **USB Display/Easy Interactive Function**.

- Press one of the Source buttons on the remote control to select the source for the image you want to annotate. To use a blank screen, select **Computer2** or another unused source

Note: You cannot use the built-in toolbar if you select the same source that is selected for Easy Interactive Tools in the Extended menu.

- Make sure you have calibrated the system. Try recalibrating.

Parent topic: [Solving Interactive Pen Problems](#)

Related references

[Projector Setup Settings - Extended Menu](#)

Solutions When the Interactive Pen Position Is Not Accurate

If the pen position is not the same as the cursor, try the following solutions:

- Make sure you have calibrated the system. Try manual calibration.
- Make sure the cable cover is in place to keep cables from blocking the signal.
- Try adjusting the pen operation area.
- If you use the **E-Zoom +** button on the remote control to enlarge the image, the pen position is not accurate. When you return to the original size, the position should be correct.

Parent topic: [Solving Interactive Pen Problems](#)

Related tasks

[Adjusting the Pen Operation Area](#)

[Calibrating Automatically](#)

[Calibrating Manually](#)

Solutions When the Interactive Pens Are Slow or Difficult to Use

If the pens are difficult to use or respond too slowly, try the following solutions:

- For easier operation, hold the pen perpendicular to the projection surface.
- For the best performance, connect your computer to the projector using a VGA computer cable for display and the USB cable for interactivity.
- If you are using USB display in Windows, you may need to disable Windows Aero in the EPSON USB Display Settings program on your computer.

Parent topic: [Solving Interactive Pen Problems](#)

Solutions When the Interactive Pens Cause Interference or Unwanted Effects

If the pens are causing interference or unwanted effects, try the following solutions:

- When both pens are used at the same time, make sure they are approximately 4 inches apart.
- Turn off the pens when they are not in use.
- Do not rest the pens on the image area of an interactive table, to avoid interference with your computer's mouse.

Parent topic: [Solving Interactive Pen Problems](#)

Solutions When Network Alert E-Mails are Not Received

If you do not receive an e-mail alerting you to problems with a projector over the network, try the following solutions:

- Make sure the projector is turned on and connected to the network correctly. (If an error shut down the projector, it cannot send an e-mail.)
- Make sure you set up the projector e-mail alert settings correctly on the projector's network Mail menu or in the network software.
- Set the **Standby Mode** setting to **Communication On** so the network software can monitor the projector in standby mode.

Parent topic: [Solving Problems](#)

Related concepts

[Wired Network Projection](#)

[Wireless Network Projection](#)

Related references

[Projector Setup Settings - Extended Menu](#)

[Projector Network Settings - Network Menu](#)

Where to Get Help

If you need to contact Epson for technical support services, use the following support options.

Internet Support

Visit Epson's support website at www.epson.com/support (U.S.) or www.epson.ca/support (Canada) for solutions to common problems with your projector. You can download utilities and documentation, get FAQs and troubleshooting advice, or e-mail Epson with your questions.

Speak to a Support Representative

To use the EPSON PrivateLine Support service, call (800) 637-7661 and enter the PIN on the EPSON PrivateLine Support card included with your projector. This service is available for the duration of your warranty period. You may also speak with a projector support specialist by dialing (562) 276-4394 (U.S.) or (905) 709-3839 (Canada).

Support hours are 6 AM to 8 PM, Pacific Time, Monday through Friday and 7 AM to 4 PM, Pacific Time, Saturday.

Days and hours of support are subject to change without notice. Toll or long distance charges may apply.

Before you call, have the following information ready:

- Product name
- Product serial number (located on the bottom or rear of the projector, or in menu system)
- Proof of purchase (such as a store receipt) and date of purchase
- Computer or video configuration
- Description of the problem

Purchase Supplies and Accessories

You can purchase screens, other optional accessories, and replacement parts from an EPSON authorized reseller. To find the nearest reseller, call 800-GO-EPSON (800-463-7766). Or you can purchase online at www.epsonstore.com (U.S. sales) or www.epson.ca (Canadian sales).

To purchase a replacement remote control, call (562) 276-4394 (U.S.) or (905) 709-3839 (for dealer referral in Canada).

Parent topic: [Solving Problems](#)

Technical Specifications

These sections list the technical specifications of your projector.

[General Projector Specifications](#)

[Projector Lamp Specifications](#)

[Remote Control Specifications](#)

[Projector Dimension Specifications](#)

[Projector Electrical Specifications](#)

[Projector Environmental Specifications](#)

[Projector Safety and Approvals Specifications](#)

[Supported Video Display Formats](#)

[USB Display System Requirements](#)

General Projector Specifications

Type of display	Poly-silicon TFT active matrix
Resolution	BrightLink 480i: 1024 × 768 pixels (XGA) BrightLink 475Wi/485Wi: 1280 × 800 pixels (WXGA)
Lens	F= 1.80 Focal length: 3.71 mm
Color reproduction	Full color, 16.77 million colors
Brightness	BrightLink 475Wi: Normal Power Consumption mode: White light output 2600 lumens (ISO 21118 standard) Color light output 2600 lumens ECO Power Consumption mode: White light output 1800 lumens (ISO 21118 standard)

	<p>BrightLink 480i: Normal Power Consumption mode: White light output 3000 lumens (ISO 21118 standard) Color light output 3000 lumens ECO Power Consumption mode: White light output 1800 lumens (ISO 21118 standard)</p> <p>BrightLink 485Wi: Normal Power Consumption mode: White light output 3100 lumens (ISO 21118 standard) Color light output 3100 lumens ECO Power Consumption mode: White light output 1800 lumens (ISO 21118 standard)</p>
Contrast ratio	3000 to 1 with Auto Iris on and Normal Power Consumption mode
Image size	<p>BrightLink 480i: 55.9 to 93.2 inches (1.42 to 2.37 m)</p> <p>BrightLink 475Wi/485Wi: 60 to 100 inches (1.52 to 2.54 m)</p>
Projection distance	13.7 to 23.5 inches (0.35 to 0.60 m)
Projection methods	Front, wall or ceiling-mounted
Optical aspect ratio (width-to-height)	<p>BrightLink 480i: 4:3</p> <p>BrightLink 475Wi/485Wi: 16:10</p>
Focus adjustment	Manual
Zoom adjustment	Digital
Zoom ratio (Tele-to-Wide)	1:1.35

Internal sound system	16 W monaural
Noise level	35 dB (Normal Power Consumption mode) 28 dB (ECO Power Consumption mode)
Keystone correction angle	Vertical: $\pm 5^\circ$ Horizontal: $\pm 5^\circ$
USB-B port compatibility	USB 1.1 and 2.0 compliant for USB display or external mouse
USB-A port compatibility	One USB 1.1 and 2.0 compliant port for USB device input or EPSON document camera display

Parent topic: [Technical Specifications](#)

Projector Lamp Specifications

Type	UHE (Ultra High Efficiency)
Power consumption	BrightLink 475Wi: 190 W BrightLink 480i/485Wi: 215 W
Lamp life	Normal Power Consumption mode: Up to about 3000 hours ECO Power Consumption mode: Up to about 4000 hours

Note: Turn off this product when not in use to prolong the life of the projector. Lamp life will vary depending upon mode selected, environmental conditions, and usage. Brightness decreases over time.

Parent topic: [Technical Specifications](#)

Remote Control Specifications

Reception range	19.7 feet (6 m)
------------------------	-----------------

Batteries Two alkaline or manganese AA

Parent topic: [Technical Specifications](#)

Projector Dimension Specifications

Height (excluding feet)	5.6 inches (143 mm)
Width	14.4 inches (367 mm)
Depth	14.8 inches (375 mm)
Weight	11.9 lb (5.4 kg)

Parent topic: [Technical Specifications](#)

Projector Electrical Specifications

Rated frequency	50/60 Hz
Power supply	100 to 240 VAC \pm 10%
	BrightLink 475Wi: 2.9 to 1.3 A
	BrightLink 480i/485Wi: 3.1 to 1.5 A
Power consumption (110 to 120 V)	Operating: BrightLink 475Wi: Normal Power Consumption mode: 287 W ECO Power Consumption mode: 223 W BrightLink 485Wi/480i: Normal Power Consumption mode: 313 W ECO Power Consumption mode: 223 W Standby: 0.21 W (Communication Off), 7.5 W (Communication On)

Power consumption
(220 to 240 V)

Operating:
BrightLink 475Wi:
Normal Power Consumption mode: 275 W
ECO Power Consumption mode: 215 W
BrightLink 480i/485Wi:
Normal Power Consumption mode: 300 W
ECO Power Consumption mode: 215 W
Standby:
0.27 W (Communication Off), 8.3 W (Communication On)

Parent topic: [Technical Specifications](#)

Projector Environmental Specifications

Temperature

Operating: 41 to 95 °F (5 to 35 °C)
Storage: 14 to 140 °F (-10 to 60 °C)

Humidity (relative, non-condensing)

Operating: 20 to 80%
Storage: 10 to 90%

Operating altitude

Up to 4921 feet (1500 m)
Up to 7500 feet (2286 m) with High Altitude Mode enabled

Parent topic: [Technical Specifications](#)

Projector Safety and Approvals Specifications

United States

FCC Part 15 Class B (DoC)
UL60950-1

Canada

ICES-003 Class B
CSA C22.2 No. 60950-1

Parent topic: [Technical Specifications](#)

Supported Video Display Formats

For best results, your computer monitor or video card resolution should be set to display in the projector's native resolution. However, your projector includes Epson's SizeWise chip that supports other computer display resolutions, so your image will be resized to fit automatically.

Your computer's monitor or video card refresh rate (vertical frequency) must be compatible with the projector. (See your computer or video card manual for details.)

The table here lists the compatible refresh rate and resolution for each compatible video display format.

Display format	Refresh rate (in Hz)	Resolution (in pixels)
Computer signals (analog RGB)		
VGA	60/72/75/85	640 × 480
SVGA	56/60/72/75/85	800 × 600
XGA	60/72/75/85	1024 × 768
WXGA	60	1280 × 768
	60	1366 × 768
	60/75/85	1280 × 800
WXGA+	60/75/85	1440 × 900
WXGA++	60	1600 × 900
SXGA	70/75/85	1152 × 864
	60/75/85	1280 × 1024
	60/75/85	1280 × 960
SXGA+	60/75	1400 × 1050
WSXGA+*	60	1680 × 1050
UXGA	60	1600 × 1200
MAC13"	67	640 × 480
MAC16"	75	832 × 624
MAC19"	75	1024 × 768
	59	1024 × 768
MAC21"	75	1152 × 870

Display format	Refresh rate (in Hz)	Resolution (in pixels)
Composite video		
TV (NTSC)	60	720 × 480
TV (SECAM)	50	720 × 576
TV (PAL)	50/60	720 × 576
Component video		
SDTV (480i)	60	720 × 480
SDTV (576i)	50	720 × 576
SDTV (480p)	60	720 × 480
SDTV (576p)	50	720 × 576
HDTV (720p)	50/60	1280 × 720
HDTV (1080i)	50/60	1920 × 1080
HDMI input signals		
VGA	60	640 × 480
SVGA	60	800 × 600
XGA	60	1024 × 768
WXGA	60	1280 × 800
	60	1366 × 768
WXGA+	60	1440 × 900
WXGA++	60	1600 × 900
WSXGA*	60	1680 × 1050
SXGA	60	1280 × 960
	60	1280 × 1024
SXGA+	60	1400 × 1050
UXGA	60	1600 × 1200
SDTV (480i/480p)	60	720 × 480
SDTV (576i/576p)	50	720 × 576

Display format	Refresh rate (in Hz)	Resolution (in pixels)
HDTV (720p)	50/60	1280 × 720
HDTV (1080i)	50/60	1920 × 1080
HDTV (1080p)	24/30/50/60	1920 × 1080

* BrightLink 475Wi/485Wi only

Parent topic: [Technical Specifications](#)

USB Display System Requirements

Your computer system must meet the system requirements here to use the projector's USB Display software.

Requirement	Windows	Mac
Operating system	Windows 2000 (Service Pack 4 only)	Mac OS X 10.5.x, 10.6.x, or 10.7.x
	Windows XP Professional, Home Edition, and Tablet PC Edition (32-bit)	
	Windows Vista Ultimate, Enterprise, Business, Home Premium, and Home Basic (32-bit)	
	Windows 7 Ultimate, Enterprise, Professional, and Home Premium (32- and 64-bit); Home Basic and Starter (32-bit)	
USB version	USB 1.1 and above (USB 2.0 recommended)	
CPU	Mobile Pentium III 1.2 GHz or faster (1.6 GHz or faster recommended)	Power PC G4 1 GHz or faster (Core Duo 1.83 GHz or faster recommended)
Memory	256MB or more (512MB or more recommended)	512MB or more
Hard disk space	20MB or more	
Display	Resolution between 640 × 480 and 1600 × 1200, 16-bit color or greater	

Parent topic: [Technical Specifications](#)

Notices

Check these sections for important notices about your projector.

[Recycling](#)

[Important Safety Information](#)

[Important Safety Instructions](#)

[FCC Compliance Statement](#)

[Wireless Telegraphy Act Regulations](#)

[Trademarks](#)

[Software Copyright](#)

[Copyright Notice](#)

Recycling

Epson offers a recycling program for end of life products. Please go to www.epson.com/recycle for information on how to return your products for proper disposal.

Parent topic: [Notices](#)

Important Safety Information

Caution: Never look into the projector lens when the lamp is turned on; the bright light can damage your eyes. Never let children look into the lens when it is on. Never open any cover on the projector, except the lamp and filter covers. Dangerous electrical voltages inside the projector can severely injure you. Except as specifically explained in this *User's Guide*, do not attempt to service this product yourself. Refer all servicing to qualified service personnel.

Warning: The projector and its accessories come packaged in plastic bags. Keep plastic bags away from small children to avoid any risk of suffocation.

Caution: When you replace the lamp, never touch the new lamp with your bare hands; the invisible residue left by the oil on your hands may shorten the lamp life. Use a cloth or glove to handle the new lamp.

Parent topic: [Notices](#)

Important Safety Instructions

Follow these safety instructions when setting up and using the projector:

- Do not look into the lens when the projector is on. The bright light can damage your eyes.
- Do not place your hand or any object near the projection window. The high temperature of this area could cause burns, fire, or other damage.
- Do not place the projector on an unstable cart, stand, or table.
- Do not operate the projector on its side, or while tilted to one side. Do not tilt the projector more than 5° forward or back.
- If the projector is mounted on a ceiling or wall, it should be installed by qualified technicians using mounting hardware designed for use with this projector.
- When installing or adjusting a ceiling or wall mount, do not use adhesives to prevent the screws from loosening and do not use oils or lubricants. This may cause the projector case to crack and the projector to fall from its ceiling mount. This could cause serious injury to anyone under the mount and could damage the projector.
- Do not use the projector near water or sources of heat.
- Use the type of power source indicated on the projector. Use of a different power source may result in fire or electric shock. If you are not sure of the power available, consult your dealer or power company.
- Place the projector near a wall outlet where the plug can be easily unplugged.
- Take the following precautions when handling the plug: Do not hold the plug with wet hands. Do not insert the plug into an outlet with dust present. Insert the plug firmly into the outlet. Do not pull the power cord when disconnecting the plug; always be sure to hold the plug when disconnecting it. Failure to comply with these precautions could result in fire or electric shock.
- Do not overload wall outlets, extension cords, or power strips. Do not insert the plug into a dusty outlet. This can cause fire or electric shock.
- Do not place the projector where the cord can be walked on. This may result in fraying or damage to the plug.
- Unplug the projector from the wall outlet before cleaning. Use a dry cloth (or, for stubborn dirt or stains, a moist cloth that has been wrung dry) for cleaning. Do not use liquid or aerosol cleaners.
- Do not block the slots and openings in the projector case. They provide ventilation and prevent the projector from overheating. Do not operate the projector on a sofa, rug, or other soft surface, or set it on top of loose papers, which could block vents underneath the projector. If you are setting up the projector near a wall, leave at least 7.9 inches (20 cm) of space between the wall and the air exhaust vent.

- Do not operate the projector in a closed-in cabinet unless proper ventilation is provided.
- Never push objects of any kind through the cabinet slots. Never spill liquid of any kind into the projector.
- If you are using two or more projectors side-by-side, leave at least 2 feet (60 cm) of space between the projectors to allow for proper ventilation.
- You may need to clean the air filter and vent. A clogged air filter or vent can block ventilation needed to cool the projector. Do not use canned air, or the gases may leave a residue.
- Do not store the projector outdoors for an extended length of time.
- Except as specifically explained in this manual, do not attempt to service this product yourself. Refer all servicing to qualified personnel. Opening or removing covers may expose you to dangerous voltages and other hazards.
- Never open any covers on the projector except as specifically explained in this manual. Never attempt to disassemble or modify the projector. Refer all repairs to qualified service personnel.
- Unplug the projector from the wall outlet and refer servicing to qualified service personnel under the following conditions: if it does not operate normally when you follow the operating instructions, or exhibits a distinct change in performance; if smoke, strange odors, or strange noises come from the projector; if the power cord or plug is damaged or frayed; if liquid or foreign objects get inside the projector, or if it has been exposed to rain or water; if it has been dropped or the housing has been damaged.
- Do not touch the plug during an electrical storm. Otherwise, you may receive an electric shock.
- Unplug the projector when it will not be used for extended periods.
- Do not use the projector where it may be exposed to rain, water, or excessive humidity.
- Do not use the projector where it may be exposed to smoke, corrosive gases, or excessive dust.
- Do not use or store the projector or remote control in a hot location, such as near a heater, in direct sunlight, or in a closed vehicle.
- If you use the projector in a country other than where you purchased it, use the correct power cord for that country.
- Do not stand on the projector or place heavy objects on it.
- Do not use the projector outside of the required temperature range of 41 to 95 °F (5 to 35 °C). Doing so may cause an unstable display and could lead to projector damage.
- Do not store the projector outside of the required temperature range of 14 to 140 °F (–10 to 60 °C) or in direct sunlight for long periods of time. Doing so may cause damage to the case.

- Do not place anything that can become warped or damaged by heat near the exhaust vents. Do not bring your hands or face close to the vents while projection is in progress.
- Before you move the projector, make sure its power is turned off, the plug is disconnected from the outlet, and all cables are disconnected.
- Never try to remove the lamp immediately after use because it will be extremely hot. Before removing the lamp, turn off the power and wait at least an hour to allow the lamp to cool completely.
- Do not disassemble the lamp or subject it to impacts.
- Do not place the source of an open flame, such as a lit candle, on or near the projector.
- Do not modify the power cord. Do not place heavy objects on top of the power cord or bend, twist, or pull it excessively. Keep the power cord away from hot electrical appliances.
- If the lamp breaks, ventilate the room to prevent gases contained in the lamp from being inhaled or coming in contact with your eyes or mouth. If you do inhale gases or gases come in contact with your eyes or mouth, seek medical advice immediately.
- If the projector is mounted overhead and the lamp breaks, be careful to prevent pieces of glass from falling into your eyes when you open the lamp cover.

Note:  The lamp(s) in this product contain mercury. Please consult your state and local regulations regarding disposal or recycling. Do not put in the trash.

WARNING: The cords included with this product contain chemicals, including lead, known to the State of California to cause birth defects or other reproductive harm. ***Wash hands after handling.*** (This notice is provided in accordance with Proposition 65 in Cal. Health & Safety Code § 25249.5 and following.)

[Restriction of Use](#)

Parent topic: [Notices](#)

Restriction of Use

When this product is used for applications requiring high reliability/safety such as transportation devices related to aviation, rail, marine, automotive; disaster prevention devices; various safety devices; or functional/precision devices, you should use this product only after giving consideration to including fail-safes and redundancies into your design to maintain safety and total system reliability.

Because this product was not intended for use in applications requiring extremely high reliability/safety such as aerospace equipment, main communication equipment, nuclear power control equipment, or medical equipment related to direct medical care, please make your own judgment on this product's suitability after a full evaluation.

Parent topic: [Important Safety Instructions](#)

FCC Compliance Statement

For United States Users

This equipment has been tested and found to comply with the limits for a Class B digital device, pursuant to Part 15 of the FCC Rules. These limits are designed to provide reasonable protection against harmful interference in a residential installation. This equipment generates, uses, and can radiate radio frequency energy and, if not installed and used in accordance with the instructions, may cause harmful interference to radio or television reception. However, there is no guarantee that interference will not occur in a particular installation. If this equipment does cause interference to radio and television reception, which can be determined by turning the equipment off and on, the user is encouraged to try to correct the interference by one or more of the following measures:

- Reorient or relocate the receiving antenna.
- Increase the separation between the equipment and receiver.
- Connect the equipment into an outlet on a circuit different from that to which the receiver is connected.
- Consult the dealer or an experienced radio/TV technician for help.

WARNING

The connection of a non-shielded equipment interface cable to this equipment will invalidate the FCC Certification or Declaration of this device and may cause interference levels which exceed the limits established by the FCC for this equipment. It is the responsibility of the user to obtain and use a shielded equipment interface cable with this device. If this equipment has more than one interface connector, do not leave cables connected to unused interfaces. Changes or modifications not expressly approved by the manufacturer could void the user's authority to operate the equipment.

For Canadian Users

This Class B digital apparatus meets all requirements of the Canadian Interference-Causing Equipment Regulations.

Cet appareil numérique de la classe B respecte toutes les exigences du Règlement sur le matériel brouilleur du Canada.

Parent topic: [Notices](#)

Wireless Telegraphy Act Regulations

The following acts are prohibited by the Wireless Telegraphy Act:

- Modifying and disassembling (including the antenna)
- Removing the label of conformance

Parent topic: [Notices](#)

Trademarks

EPSON®, BrightLink®, PowerLite®, Instant Off®, and Quick Corner® are registered trademarks, and EPSON Exceed Your Vision is a registered logomark of Seiko Epson Corporation.

PrivateLine® is a registered trademark, and EPSON StoreSM and Extra CareSM are service marks of Epson America, Inc.

HDMI and High-Definition Multimedia Interface are the trademarks or registered trademarks of HDMI Licensing LLC.  HIGH DEFINITION MULTIMEDIA INTERFACE

General Notice: Other product names used herein are for identification purposes only and may be trademarks of their respective owners. Epson disclaims any and all rights in those marks.



Parent topic: [Notices](#)

Software Copyright

GNU GPL

This projector product includes the open source software programs which apply the GNU General Public License Version 2 or later version ("GPL Programs").

We provide the source code of the GPL Programs until five (5) years after the discontinuation of same model of this projector product.

If you desire to receive the source code of the GPL Programs, contact Epson as described in the *User's Guide*.

These GPL Programs are WITHOUT ANY WARRANTY; without even the implied warranty of MERCHANTABILITY AND FITNESS FOR A PARTICULAR PURPOSE.

See the GNU General Public License for more details.

The list of GPL Programs is as follows and the names of author are described in the source code of the GPL Programs

The list of GPL Programs

- **busybox-1.13.4**
- **iptables-1.4.4**
- **libgcc1(gcc-4.3.3)**
- **libstdc++-6.0.10**
- **linux-2.6.27**
- **patches**
- **udhcp 0.9.8**
- **uvc rev.219**
- **wireless_tools 29**
- **EPSON original drivers**

The GNU General Public License Version 2 is as follows. You also can see the GNU General Public License Version 2 at <http://www.gnu.org/licenses/gpl.html>

GNU GENERAL PUBLIC LICENSE

Version 2, June 1991

Copyright ©) 1989, 1991 Free Software Foundation, Inc., 51 Franklin Street , Fifth Floor, Boston , MA 02110-1301 USA

Everyone is permitted to copy and distribute verbatim copies of this license document, but changing it is not allowed.

Preamble

The licenses for most software are designed to take away your freedom to share and change it. By contrast, the GNU General Public License is intended to guarantee your freedom to share and change free software--to make sure the software is free for all its users. This General Public License applies to most of the Free Software Foundation's software and to any other program whose authors commit to using it. (Some other Free Software Foundation software is covered by the GNU Lesser General Public License instead.) You can apply it to your programs, too.

When we speak of free software, we are referring to freedom, not price. Our General Public Licenses are designed to make sure that you have the freedom to distribute copies of free software (and charge for

this service if you wish), that you receive source code or can get it if you want it, that you can change the software or use pieces of it in new free programs; and that you know you can do these things.

To protect your rights, we need to make restrictions that forbid anyone to deny you these rights or to ask you to surrender the rights. These restrictions translate to certain responsibilities for you if you distribute copies of the software, or if you modify it.

For example, if you distribute copies of such a program, whether gratis or for a fee, you must give the recipients all the rights that you have. You must make sure that they, too, receive or can get the source code. And you must show them these terms so they know their rights.

We protect your rights with two steps: (1) copyright the software, and (2) offer you this license which gives you legal permission to copy, distribute and/or modify the software.

Also, for each author's protection and ours, we want to make certain that everyone understands that there is no warranty for this free software. If the software is modified by someone else and passed on, we want its recipients to know that what they have is not the original, so that any problems introduced by others will not reflect on the original authors' reputations.

Finally, any free program is threatened constantly by software patents. We wish to avoid the danger that redistributors of a free program will individually obtain patent licenses, in effect making the program proprietary. To prevent this, we have made it clear that any patent must be licensed for everyone's free use or not licensed at all.

The precise terms and conditions for copying, distribution and modification follow.

GNU GENERAL PUBLIC LICENSE TERMS AND CONDITIONS FOR COPYING, DISTRIBUTION AND MODIFICATION

0. This License applies to any program or other work which contains a notice placed by the copyright holder saying it may be distributed under the terms of this General Public License. The "Program", below, refers to any such program or work, and a "work based on the Program" means either the Program or any derivative work under copyright law: that is to say, a work containing the Program or a portion of it, either verbatim or with modifications and/or translated into another language. (Hereinafter, translation is included without limitation in the term "modification".) Each licensee is addressed as "you".

Activities other than copying, distribution and modification are not covered by this License; they are outside its scope. The act of running the Program is not restricted, and the output from the Program is covered only if its contents constitute a work based on the Program (independent of having been made by running the Program). Whether that is true depends on what the Program does.

1. You may copy and distribute verbatim copies of the Program's source code as you receive it, in any medium, provided that you conspicuously and appropriately publish on each copy an appropriate copyright notice and disclaimer of warranty; keep intact all the notices that refer to this License and to the absence of any warranty; and give any other recipients of the Program a copy of this License along with the Program.

You may charge a fee for the physical act of transferring a copy, and you may at your option offer warranty protection in exchange for a fee.

2. You may modify your copy or copies of the Program or any portion of it, thus forming a work based on the Program, and copy and distribute such modifications or work under the terms of Section 1 above, provided that you also meet all of these conditions:

- a) You must cause the modified files to carry prominent notices stating that you changed the files and the date of any change.
- b) You must cause any work that you distribute or publish, that in whole or in part contains or is derived from the Program or any part thereof, to be licensed as a whole at no charge to all third parties under the terms of this License.
- c) If the modified program normally reads commands interactively when run, you must cause it, when started running for such interactive use in the most ordinary way, to print or display an announcement including an appropriate copyright notice and a notice that there is no warranty (or else, saying that you provide a warranty) and that users may redistribute the program under these conditions, and telling the user how to view a copy of this License. (Exception: if the Program itself is interactive but does not normally print such an announcement, your work based on the Program is not required to print an announcement.)

These requirements apply to the modified work as a whole. If identifiable sections of that work are not derived from the Program, and can be reasonably considered independent and separate works in themselves, then this License, and its terms, do not apply to those sections when you distribute them as separate works. But when you distribute the same sections as part of a whole which is a work based on the Program, the distribution of the whole must be on the terms of this License, whose permissions for other licensees extend to the entire whole, and thus to each and every part regardless of who wrote it.

Thus, it is not the intent of this section to claim rights or contest your rights to work written entirely by you; rather, the intent is to exercise the right to control the distribution of derivative or collective works based on the Program.

In addition, mere aggregation of another work not based on the Program with the Program (or with a work based on the Program) on a volume of a storage or distribution medium does not bring the other work under the scope of this License.

3. You may copy and distribute the Program (or a work based on it, under Section 2) in object code or executable form under the terms of Sections 1 and 2 above provided that you also do one of the following:

- a) Accompany it with the complete corresponding machine-readable source code, which must be distributed under the terms of Sections 1 and 2 above on a medium customarily used for software interchange; or,

b) Accompany it with a written offer, valid for at least three years, to give any third party, for a charge no more than your cost of physically performing source distribution, a complete machine-readable copy of the corresponding source code, to be distributed under the terms of Sections 1 and 2 above on a medium customarily used for software interchange; or,

c) Accompany it with the information you received as to the offer to distribute corresponding source code. (This alternative is allowed only for noncommercial distribution and only if you received the program in object code or executable form with such an offer, in accord with Subsection b above.)

The source code for a work means the preferred form of the work for making modifications to it. For an executable work, complete source code means all the source code for all modules it contains, plus any associated interface definition files, plus the scripts used to control compilation and installation of the executable. However, as a special exception, the source code distributed need not include anything that is normally distributed (in either source or binary form) with the major components (compiler, kernel, and so on) of the operating system on which the executable runs, unless that component itself accompanies the executable.

If distribution of executable or object code is made by offering access to copy from a designated place, then offering equivalent access to copy the source code from the same place counts as distribution of the source code, even though third parties are not compelled to copy the source along with the object code.

4. You may not copy, modify, sublicense, or distribute the Program except as expressly provided under this License. Any attempt otherwise to copy, modify, sublicense or distribute the Program is void, and will automatically terminate your rights under this License. However, parties who have received copies, or rights, from you under this License will not have their licenses terminated so long as such parties remain in full compliance.

5. You are not required to accept this License, since you have not signed it. However, nothing else grants you permission to modify or distribute the Program or its derivative works. These actions are prohibited by law if you do not accept this License. Therefore, by modifying or distributing the Program (or any work based on the Program), you indicate your acceptance of this License to do so, and all its terms and conditions for copying, distributing or modifying the Program or works based on it.

6. Each time you redistribute the Program (or any work based on the Program), the recipient automatically receives a license from the original licensor to copy, distribute or modify the Program subject to these terms and conditions. You may not impose any further restrictions on the recipients' exercise of the rights granted herein. You are not responsible for enforcing compliance by third parties to this License.

7. If, as a consequence of a court judgment or allegation of patent infringement or for any other reason (not limited to patent issues), conditions are imposed on you (whether by court order, agreement or otherwise) that contradict the conditions of this License, they do not excuse you from the conditions of this License. If you cannot distribute so as to satisfy simultaneously your obligations under this License and any other pertinent obligations, then as a consequence you may not distribute the Program at all.

For example, if a patent license would not permit royalty-free redistribution of the Program by all those who receive copies directly or indirectly through you, then the only way you could satisfy both it and this License would be to refrain entirely from distribution of the Program.

If any portion of this section is held invalid or unenforceable under any particular circumstance, the balance of the section is intended to apply and the section as a whole is intended to apply in other circumstances.

It is not the purpose of this section to induce you to infringe any patents or other property right claims or to contest validity of any such claims; this section has the sole purpose of protecting the integrity of the free software distribution system, which is implemented by public license practices. Many people have made generous contributions to the wide range of software distributed through that system in reliance on consistent application of that system; it is up to the author/donor to decide if he or she is willing to distribute software through any other system and a licensee cannot impose that choice.

This section is intended to make thoroughly clear what is believed to be a consequence of the rest of this License.

8. If the distribution and/or use of the Program is restricted in certain countries either by patents or by copyrighted interfaces, the original copyright holder who places the Program under this License may add an explicit geographical distribution limitation excluding those countries, so that distribution is permitted only in or among countries not thus excluded. In such case, this License incorporates the limitation as if written in the body of this License.

9. The Free Software Foundation may publish revised and/or new versions of the General Public License from time to time. Such new versions will be similar in spirit to the present version, but may differ in detail to address new problems or concerns.

Each version is given a distinguishing version number. If the Program specifies a version number of this License which applies to it and "any later version", you have the option of following the terms and conditions either of that version or of any later version published by the Free Software Foundation. If the Program does not specify a version number of this License, you may choose any version ever published by the Free Software Foundation.

10. If you wish to incorporate parts of the Program into other free programs whose distribution conditions are different, write to the author to ask for permission. For software which is copyrighted by the Free Software Foundation, write to the Free Software Foundation; we sometimes make exceptions for this. Our decision will be guided by the two goals of preserving the free status of all derivatives of our free software and of promoting the sharing and reuse of software generally.

NO WARRANTY

11. BECAUSE THE PROGRAM IS LICENSED FREE OF CHARGE, THERE IS NO WARRANTY FOR THE PROGRAM, TO THE EXTENT PERMITTED BY APPLICABLE LAW. EXCEPT WHEN OTHERWISE STATED IN WRITING THE COPYRIGHT HOLDERS AND/OR OTHER PARTIES

PROVIDE THE PROGRAM "AS IS" WITHOUT WARRANTY OF ANY KIND, EITHER EXPRESSED OR IMPLIED, INCLUDING, BUT NOT LIMITED TO, THE IMPLIED WARRANTIES OF MERCHANTABILITY AND FITNESS FOR A PARTICULAR PURPOSE. THE ENTIRE RISK AS TO THE QUALITY AND PERFORMANCE OF THE PROGRAM IS WITH YOU. SHOULD THE PROGRAM PROVE DEFECTIVE, YOU ASSUME THE COST OF ALL NECESSARY SERVICING, REPAIR OR CORRECTION.

12. IN NO EVENT UNLESS REQUIRED BY APPLICABLE LAW OR AGREED TO IN WRITING WILL ANY COPYRIGHT HOLDER, OR ANY OTHER PARTY WHO MAY MODIFY AND/OR REDISTRIBUTE THE PROGRAM AS PERMITTED ABOVE, BE LIABLE TO YOU FOR DAMAGES, INCLUDING ANY GENERAL, SPECIAL, INCIDENTAL OR CONSEQUENTIAL DAMAGES ARISING OUT OF THE USE OR INABILITY TO USE THE PROGRAM (INCLUDING BUT NOT LIMITED TO LOSS OF DATA OR DATA BEING RENDERED INACCURATE OR LOSSES SUSTAINED BY YOU OR THIRD PARTIES OR A FAILURE OF THE PROGRAM TO OPERATE WITH ANY OTHER PROGRAMS), EVEN IF SUCH HOLDER OR OTHER PARTY HAS BEEN ADVISED OF THE POSSIBILITY OF SUCH DAMAGES.

END OF TERMS AND CONDITIONS

How to Apply These Terms to Your New Programs

If you develop a new program, and you want it to be of the greatest possible use to the public, the best way to achieve this is to make it free software which everyone can redistribute and change under these terms.

To do so, attach the following notices to the program. It is safest to attach them to the start of each source file to most effectively convey the exclusion of warranty; and each file should have at least the "copyright" line and a pointer to where the full notice is found.

<one line to give the program's name and a brief idea of what it does.>

Copyright ©) <year> <name of author>

This program is free software; you can redistribute it and/or modify it under the terms of the GNU General Public License as published by the Free Software Foundation; either version 2 of the License, or (at your option) any later version.

This program is distributed in the hope that it will be useful, but WITHOUT ANY WARRANTY; without even the implied warranty of MERCHANTABILITY or FITNESS FOR A PARTICULAR PURPOSE. See the GNU General Public License for more details.

You should have received a copy of the GNU General Public License along with this program; if not, write to the Free Software Foundation, Inc., 51 Franklin Street, Fifth Floor, Boston, MA 02110-1301 USA.

Also add information on how to contact you by electronic and paper mail.

If the program is interactive, make it output a short notice like this when it starts in an interactive mode:

Gnomovision version 69, Copyright ©) year name of author

Gnomovision comes with ABSOLUTELY NO WARRANTY; for details type `show w'. This is free software, and you are welcome to redistribute it under certain conditions; type `show c' for details.

The hypothetical commands `show w' and `show c' should show the appropriate parts of the General Public License. Of course, the commands you use may be called something other than `show w' and `show c'; they could even be mouse-clicks or menu items--whatever suits your program.

You should also get your employer (if you work as a programmer) or your school, if any, to sign a "copyright disclaimer" for the program, if necessary. Here is a sample; alter the names:

Yoyodyne, Inc., hereby disclaims all copyright interest in the program 'Gnomovision' (which makes passes at compilers) written by James Hacker.

<signature of Ty Coon>, 1 April 1989

Ty Coon, President of Vice

This General Public License does not permit incorporating your program into proprietary programs. If your program is a subroutine library, you may consider it more useful to permit linking proprietary applications with the library. If this is what you want to do, use the GNU Lesser General Public License instead of this License.

GNU LGPL

This projector product includes the open source software programs which apply the GNU Lesser General Public License Version 2 or later version ("LGPL Programs").

We provide the source code of the LGPL Programs until five (5) years after the discontinuation of same model of this projector product.

If you desire to receive the source code of the LGPL Programs, contact Epson as described in the *User's Guide*.

These LGPL Programs are WITHOUT ANY WARRANTY; without even the implied warranty of MERCHANTABILITY AND FITNESS FOR A PARTICULAR PURPOSE.

See the GNU General Public License for more details.

The list of LGPL Programs is as follows and the names of author are described in the source code of the LGPL Programs.

LGPL Programs

- **glibc-2.8**
- **SDL-1.2.13**
- **SDL-Image**

The GNU Lesser General Public License Version 2 is as follows. You also can see the GNU Lesser General Public License Version 2 at <http://www.gnu.org/licenses/lgpl.html>

GNU LESSER GENERAL PUBLIC LICENSE

Version 2.1, February 1999

Copyright ©) 1991, 1999 Free Software Foundation, Inc. 51 Franklin Street, Fifth Floor, Boston, MA 02110-1301 USA

Everyone is permitted to copy and distribute verbatim copies of this license document, but changing it is not allowed.

[This is the first released version of the Lesser GPL. It also counts as the successor of the GNU Library Public License, version 2, hence the version number 2.1.]

Preamble

The licenses for most software are designed to take away your freedom to share and change it. By contrast, the GNU General Public Licenses are intended to guarantee your freedom to share and change free software--to make sure the software is free for all its users.

This license, the Lesser General Public License, applies to some specially designated software packages--typically libraries--of the Free Software Foundation and other authors who decide to use it. You can use it too, but we suggest you first think carefully about whether this license or the ordinary General Public License is the better strategy to use in any particular case, based on the explanations below.

When we speak of free software, we are referring to freedom of use, not price. Our General Public Licenses are designed to make sure that you have the freedom to distribute copies of free software (and charge for this service if you wish); that you receive source code or can get it if you want it; that you can change the software and use pieces of it in new free programs; and that you are informed that you can do these things.

To protect your rights, we need to make restrictions that forbid distributors to deny you these rights or to ask you to surrender these rights. These restrictions translate to certain responsibilities for you if you distribute copies of the library or if you modify it.

For example, if you distribute copies of the library, whether gratis or for a fee, you must give the recipients all the rights that we gave you. You must make sure that they, too, receive or can get the source code. If you link other code with the library, you must provide complete object files to the recipients, so that they can relink them with the library after making changes to the library and recompiling it. And you must show them these terms so they know their rights.

We protect your rights with a two-step method: (1) we copyright the library, and (2) we offer you this license, which gives you legal permission to copy, distribute and/or modify the library.

To protect each distributor, we want to make it very clear that there is no warranty for the free library. Also, if the library is modified by someone else and passed on, the recipients should know that what they have is not the original version, so that the original author's reputation will not be affected by problems that might be introduced by others.

Finally, software patents pose a constant threat to the existence of any free program. We wish to make sure that a company cannot effectively restrict the users of a free program by obtaining a restrictive license from a patent holder. Therefore, we insist that any patent license obtained for a version of the library must be consistent with the full freedom of use specified in this license.

Most GNU software, including some libraries, is covered by the ordinary GNU General Public License. This license, the GNU Lesser General Public License, applies to certain designated libraries, and is quite different from the ordinary General Public License. We use this license for certain libraries in order to permit linking those libraries into non-free programs.

When a program is linked with a library, whether statically or using a shared library, the combination of the two is legally speaking a combined work, a derivative of the original library. The ordinary General Public License therefore permits such linking only if the entire combination fits its criteria of freedom. The Lesser General Public License permits more lax criteria for linking other code with the library.

We call this license the "Lesser" General Public License because it does Less to protect the user's freedom than the ordinary General Public License. It also provides other free software developers Less of an advantage over competing non-free programs. These disadvantages are the reason we use the ordinary General Public License for many libraries. However, the Lesser license provides advantages in certain special circumstances.

For example, on rare occasions, there may be a special need to encourage the widest possible use of a certain library, so that it becomes a de-facto standard. To achieve this, non-free programs must be allowed to use the library. A more frequent case is that a free library does the same job as widely used non-free libraries. In this case, there is little to gain by limiting the free library to free software only, so we use the Lesser General Public License.

In other cases, permission to use a particular library in non-free programs enables a greater number of people to use a large body of free software. For example, permission to use the GNU C Library in non-free programs enables many more people to use the whole GNU operating system, as well as its variant, the GNU/Linux operating system.

Although the Lesser General Public License is Less protective of the users' freedom, it does ensure that the user of a program that is linked with the Library has the freedom and the wherewithal to run that program using a modified version of the Library.

The precise terms and conditions for copying, distribution and modification follow. Pay close attention to the difference between a "work based on the library" and a "work that uses the library". The former contains code derived from the library, whereas the latter must be combined with the library in order to run.

GNU LESSER GENERAL PUBLIC LICENSE TERMS AND CONDITIONS FOR COPYING, DISTRIBUTION AND MODIFICATION

0. This License Agreement applies to any software library or other program which contains a notice placed by the copyright holder or other authorized party saying it may be distributed under the terms of this Lesser General Public License (also called "this License"). Each licensee is addressed as "you".

A "library" means a collection of software functions and/or data prepared so as to be conveniently linked with application programs (which use some of those functions and data) to form executables.

The "Library", below, refers to any such software library or work which has been distributed under these terms. A "work based on the Library" means either the Library or any derivative work under copyright law: that is to say, a work containing the Library or a portion of it, either verbatim or with modifications and/or translated straightforwardly into another language. (Hereinafter, translation is included without limitation in the term "modification".)

"Source code" for a work means the preferred form of the work for making modifications to it. For a library, complete source code means all the source code for all modules it contains, plus any associated interface definition files, plus the scripts used to control compilation and installation of the library.

Activities other than copying, distribution and modification are not covered by this License; they are outside its scope. The act of running a program using the Library is not restricted, and output from such a program is covered only if its contents constitute a work based on the Library (independent of the use of the Library in a tool for writing it). Whether that is true depends on what the Library does and what the program that uses the Library does.

1. You may copy and distribute verbatim copies of the Library's complete source code as you receive it, in any medium, provided that you conspicuously and appropriately publish on each copy an appropriate copyright notice and disclaimer of warranty; keep intact all the notices that refer to this License and to the absence of any warranty; and distribute a copy of this License along with the Library.

You may charge a fee for the physical act of transferring a copy, and you may at your option offer warranty protection in exchange for a fee.

2. You may modify your copy or copies of the Library or any portion of it, thus forming a work based on the Library, and copy and distribute such modifications or work under the terms of Section 1 above, provided that you also meet all of these conditions:

- a) The modified work must itself be a software library.
- b) You must cause the files modified to carry prominent notices stating that you changed the files and the date of any change.
- c) You must cause the whole of the work to be licensed at no charge to all third parties under the terms of this License.

d) If a facility in the modified Library refers to a function or a table of data to be supplied by an application program that uses the facility, other than as an argument passed when the facility is invoked, then you must make a good faith effort to ensure that, in the event an application does not supply such function or table, the facility still operates, and performs whatever part of its purpose remains meaningful.

(For example, a function in a library to compute square roots has a purpose that is entirely well-defined independent of the application. Therefore, Subsection 2d requires that any application-supplied function or table used by this function must be optional: if the application does not supply it, the square root function must still compute square roots.)

These requirements apply to the modified work as a whole. If identifiable sections of that work are not derived from the Library, and can be reasonably considered independent and separate works in themselves, then this License, and its terms, do not apply to those sections when you distribute them as separate works. But when you distribute the same sections as part of a whole which is a work based on the Library, the distribution of the whole must be on the terms of this License, whose permissions for other licensees extend to the entire whole, and thus to each and every part regardless of who wrote it.

Thus, it is not the intent of this section to claim rights or contest your rights to work written entirely by you; rather, the intent is to exercise the right to control the distribution of derivative or collective works based on the Library.

In addition, mere aggregation of another work not based on the Library with the Library (or with a work based on the Library) on a volume of a storage or distribution medium does not bring the other work under the scope of this License.

3. You may opt to apply the terms of the ordinary GNU General Public License instead of this License to a given copy of the Library. To do this, you must alter all the notices that refer to this License, so that they refer to the ordinary GNU General Public License, version 2, instead of to this License. (If a newer version than version 2 of the ordinary GNU General Public License has appeared, then you can specify that version instead if you wish.) Do not make any other change in these notices.

Once this change is made in a given copy, it is irreversible for that copy, so the ordinary GNU General Public License applies to all subsequent copies and derivative works made from that copy.

This option is useful when you wish to copy part of the code of the Library into a program that is not a library.

4. You may copy and distribute the Library (or a portion or derivative of it, under Section 2) in object code or executable form under the terms of Sections 1 and 2 above provided that you accompany it with the complete corresponding machine-readable source code, which must be distributed under the terms of Sections 1 and 2 above on a medium customarily used for software interchange.

If distribution of object code is made by offering access to copy from a designated place, then offering equivalent access to copy the source code from the same place satisfies the requirement to distribute the source code, even though third parties are not compelled to copy the source along with the object code.

5. A program that contains no derivative of any portion of the Library, but is designed to work with the Library by being compiled or linked with it, is called a "work that uses the Library". Such a work, in isolation, is not a derivative work of the Library, and therefore falls outside the scope of this License.

However, linking a "work that uses the Library" with the Library creates an executable that is a derivative of the Library (because it contains portions of the Library), rather than a "work that uses the library". The executable is therefore covered by this License. Section 6 states terms for distribution of such executables.

When a "work that uses the Library" uses material from a header file that is part of the Library, the object code for the work may be a derivative work of the Library even though the source code is not. Whether this is true is especially significant if the work can be linked without the Library, or if the work is itself a library. The threshold for this to be true is not precisely defined by law.

If such an object file uses only numerical parameters, data structure layouts and accessors, and small macros and small inline functions (ten lines or less in length), then the use of the object file is unrestricted, regardless of whether it is legally a derivative work. (Executables containing this object code plus portions of the Library will still fall under Section 6.)

Otherwise, if the work is a derivative of the Library, you may distribute the object code for the work under the terms of Section 6. Any executables containing that work also fall under Section 6, whether or not they are linked directly with the Library itself.

6. As an exception to the Sections above, you may also combine or link a "work that uses the Library" with the Library to produce a work containing portions of the Library, and distribute that work under terms of your choice, provided that the terms permit modification of the work for the customer's own use and reverse engineering for debugging such modifications.

You must give prominent notice with each copy of the work that the Library is used in it and that the Library and its use are covered by this License. You must supply a copy of this License. If the work during execution displays copyright notices, you must include the copyright notice for the Library among them, as well as a reference directing the user to the copy of this License. Also, you must do one of these things:

a) Accompany the work with the complete corresponding machine-readable source code for the Library including whatever changes were used in the work (which must be distributed under Sections 1 and 2 above); and, if the work is an executable linked with the Library, with the complete machine-readable "work that uses the Library", as object code and/or source code, so that the user can modify the Library and then relink to produce a modified executable containing the modified Library. (It is understood that the user who changes the contents of definitions files in the Library will not necessarily be able to recompile the application to use the modified definitions.)

b) Use a suitable shared library mechanism for linking with the Library. A suitable mechanism is one that (1) uses at run time a copy of the library already present on the user's computer system, rather than copying library functions into the executable, and (2) will operate properly with a modified version of the

library, if the user installs one, as long as the modified version is interface-compatible with the version that the work was made with.

c) Accompany the work with a written offer, valid for at least three years, to give the same user the materials specified in Subsection 6a, above, for a charge no more than the cost of performing this distribution.

d) If distribution of the work is made by offering access to copy from a designated place, offer equivalent access to copy the above specified materials from the same place.

e) Verify that the user has already received a copy of these materials or that you have already sent this user a copy.

For an executable, the required form of the "work that uses the Library" must include any data and utility programs needed for reproducing the executable from it. However, as a special exception, the materials to be distributed need not include anything that is normally distributed (in either source or binary form) with the major components (compiler, kernel, and so on) of the operating system on which the executable runs, unless that component itself accompanies the executable.

It may happen that this requirement contradicts the license restrictions of other proprietary libraries that do not normally accompany the operating system. Such a contradiction means you cannot use both them and the Library together in an executable that you distribute.

7. You may place library facilities that are a work based on the Library side-by-side in a single library together with other library facilities not covered by this License, and distribute such a combined library, provided that the separate distribution of the work based on the Library and of the other library facilities is otherwise permitted, and provided that you do these two things:

a) Accompany the combined library with a copy of the same work based on the Library, uncombined with any other library facilities. This must be distributed under the terms of the Sections above.

b) Give prominent notice with the combined library of the fact that part of it is a work based on the Library, and explaining where to find the accompanying uncombined form of the same work.

8. You may not copy, modify, sublicense, link with, or distribute the Library except as expressly provided under this License. Any attempt otherwise to copy, modify, sublicense, link with, or distribute the Library is void, and will automatically terminate your rights under this License. However, parties who have received copies, or rights, from you under this License will not have their licenses terminated so long as such parties remain in full compliance.

9. You are not required to accept this License, since you have not signed it. However, nothing else grants you permission to modify or distribute the Library or its derivative works. These actions are prohibited by law if you do not accept this License. Therefore, by modifying or distributing the Library (or any work based on the Library), you indicate your acceptance of this License to do so, and all its terms and conditions for copying, distributing or modifying the Library or works based on it.

10. Each time you redistribute the Library (or any work based on the Library), the recipient automatically receives a license from the original licensor to copy, distribute, link with or modify the Library subject to these terms and conditions. You may not impose any further restrictions on the recipients' exercise of the rights granted herein. You are not responsible for enforcing compliance by third parties with this License.

11. If, as a consequence of a court judgment or allegation of patent infringement or for any other reason (not limited to patent issues), conditions are imposed on you (whether by court order, agreement or otherwise) that contradict the conditions of this License, they do not excuse you from the conditions of this License. If you cannot distribute so as to satisfy simultaneously your obligations under this License and any other pertinent obligations, then as a consequence you may not distribute the Library at all. For example, if a patent license would not permit royalty-free redistribution of the Library by all those who receive copies directly or indirectly through you, then the only way you could satisfy both it and this License would be to refrain entirely from distribution of the Library.

If any portion of this section is held invalid or unenforceable under any particular circumstance, the balance of the section is intended to apply, and the section as a whole is intended to apply in other circumstances.

It is not the purpose of this section to induce you to infringe any patents or other property right claims or to contest validity of any such claims; this section has the sole purpose of protecting the integrity of the free software distribution system which is implemented by public license practices. Many people have made generous contributions to the wide range of software distributed through that system in reliance on consistent application of that system; it is up to the author/donor to decide if he or she is willing to distribute software through any other system and a licensee cannot impose that choice.

This section is intended to make thoroughly clear what is believed to be a consequence of the rest of this License.

12. If the distribution and/or use of the Library is restricted in certain countries either by patents or by copyrighted interfaces, the original copyright holder who places the Library under this License may add an explicit geographical distribution limitation excluding those countries, so that distribution is permitted only in or among countries not thus excluded. In such case, this License incorporates the limitation as if written in the body of this License.

13. The Free Software Foundation may publish revised and/or new versions of the Lesser General Public License from time to time. Such new versions will be similar in spirit to the present version, but may differ in detail to address new problems or concerns. Each version is given a distinguishing version number. If the Library specifies a version number of this License which applies to it and "any later version", you have the option of following the terms and conditions either of that version or of any later version published by the Free Software Foundation. If the Library does not specify a license version number, you may choose any version ever published by the Free Software Foundation.

14. If you wish to incorporate parts of the Library into other free programs whose distribution conditions are incompatible with these, write to the author to ask for permission. For software which is copyrighted

by the Free Software Foundation, write to the Free Software Foundation; we sometimes make exceptions for this. Our decision will be guided by the two goals of preserving the free status of all derivatives of our free software and of promoting the sharing and reuse of software generally.

NO WARRANTY

15. BECAUSE THE LIBRARY IS LICENSED FREE OF CHARGE, THERE IS NO WARRANTY FOR THE LIBRARY, TO THE EXTENT PERMITTED BY APPLICABLE LAW. EXCEPT WHEN OTHERWISE STATED IN WRITING THE COPYRIGHT HOLDERS AND/OR OTHER PARTIES PROVIDE THE LIBRARY "AS IS" WITHOUT WARRANTY OF ANY KIND, EITHER EXPRESSED OR IMPLIED, INCLUDING, BUT NOT LIMITED TO, THE IMPLIED WARRANTIES OF MERCHANTABILITY AND FITNESS FOR A PARTICULAR PURPOSE. THE ENTIRE RISK AS TO THE QUALITY AND PERFORMANCE OF THE LIBRARY IS WITH YOU. SHOULD THE LIBRARY PROVE DEFECTIVE, YOU ASSUME THE COST OF ALL NECESSARY SERVICING, REPAIR OR CORRECTION.

16. IN NO EVENT UNLESS REQUIRED BY APPLICABLE LAW OR AGREED TO IN WRITING WILL ANY COPYRIGHT HOLDER, OR ANY OTHER PARTY WHO MAY MODIFY AND/OR REDISTRIBUTE THE LIBRARY AS PERMITTED ABOVE, BE LIABLE TO YOU FOR DAMAGES, INCLUDING ANY GENERAL, SPECIAL, INCIDENTAL OR CONSEQUENTIAL DAMAGES ARISING OUT OF THE USE OR INABILITY TO USE THE LIBRARY (INCLUDING BUT NOT LIMITED TO LOSS OF DATA OR DATA BEING RENDERED INACCURATE OR LOSSES SUSTAINED BY YOU OR THIRD PARTIES OR A FAILURE OF THE LIBRARY TO OPERATE WITH ANY OTHER SOFTWARE), EVEN IF SUCH HOLDER OR OTHER PARTY HAS BEEN ADVISED OF THE POSSIBILITY OF SUCH DAMAGES.

END OF TERMS AND CONDITIONS

How to Apply These Terms to Your New Libraries

If you develop a new library, and you want it to be of the greatest possible use to the public, we recommend making it free software that everyone can redistribute and change. You can do so by permitting redistribution under these terms (or, alternatively, under the terms of the ordinary General Public License).

To apply these terms, attach the following notices to the library. It is safest to attach them to the start of each source file to most effectively convey the exclusion of warranty; and each file should have at least the "copyright" line and a pointer to where the full notice is found.

<one line to give the library's name and a brief idea of what it does.>

Copyright ©) <year> <name of author>

This library is free software; you can redistribute it and/or modify it under the terms of the GNU Lesser General Public License as published by the Free Software Foundation; either version 2.1 of the License, or (at your option) any later version.

This library is distributed in the hope that it will be useful, but WITHOUT ANY WARRANTY; without even the implied warranty of MERCHANTABILITY or FITNESS FOR A PARTICULAR PURPOSE. See the GNU Lesser General Public License for more details.

You should have received a copy of the GNU Lesser General Public License along with this library; if not, write to the Free Software Foundation, Inc., 51 Franklin Street, Fifth Floor, Boston, MA 02110-1301 USA

Also add information on how to contact you by electronic and paper mail.

You should also get your employer (if you work as a programmer) or your school, if any, to sign a "copyright disclaimer" for the library, if necessary. Here is a sample; alter the names:

Yoyodyne, Inc., hereby disclaims all copyright interest in the library `Frob' (a library for tweaking knobs) written by James Random Hacker.

<signature of Ty Coon>, 1 April 1990

Ty Coon, President of Vice

That's all there is to it!

BSD License (Berkeley Software Distribution License)

This projector product includes the open source software program "University of California , Berkeley License (Berkeley Software Distribution License)" which applies the terms and conditions provided by owner of the copyright to the "BSD License".

The "BSD License" are WITHOUT ANY WARRANTY; without even the implied warranty of MERCHANTABILITY AND FITNESS FOR A PARTICULAR PURPOSE.

List of BSD License programs

busybox-1.13.4

License terms of conditions of each program which are provided by owner of the copyright to the "BSD License" are as follows.

Copyright (c) The Regents of the University of California .

All rights reserved.

This code is derived from software contributed to Berkeley by Kenneth Almquist.

Redistribution and use in source and binary forms, with or without modification, are permitted provided that the following conditions are met:

1. Redistributions of source code must retain the above copyright notice, this list of conditions and the following disclaimer.

2. Redistributions in binary form must reproduce the above copyright notice, this list of conditions and the following disclaimer in the documentation and/or other materials provided with the distribution.

3. Neither the name of the University nor the names of its contributors may be used to endorse or promote products derived from this software without specific prior written permission.

THIS SOFTWARE IS PROVIDED BY THE REGENTS AND CONTRIBUTORS "AS IS" AND ANY EXPRESS OR IMPLIED WARRANTIES, INCLUDING, BUT NOT LIMITED TO, THE IMPLIED WARRANTIES OF MERCHANTABILITY AND FITNESS FOR A PARTICULAR PURPOSE ARE DISCLAIMED. IN NO EVENT SHALL THE REGENTS OR CONTRIBUTORS BE LIABLE FOR ANY DIRECT, INDIRECT, INCIDENTAL, SPECIAL, EXEMPLARY, OR CONSEQUENTIAL DAMAGES (INCLUDING, BUT NOT LIMITED TO, PROCUREMENT OF SUBSTITUTE GOODS OR SERVICES; LOSS OF USE, DATA, OR PROFITS; OR BUSINESS INTERRUPTION) HOWEVER CAUSED AND ON ANY THEORY OF LIABILITY, WHETHER IN CONTRACT, STRICT LIABILITY, OR TORT (INCLUDING NEGLIGENCE OR OTHERWISE) ARISING IN ANY WAY OUT OF THE USE OF THIS SOFTWARE, EVEN IF ADVISED OF THE POSSIBILITY OF SUCH DAMAGE.

libjpeg

This projector product includes the open source software program "libjpeg" which applies the terms and conditions provided by owner of the copyright to the "libjpeg".

The "libjpeg" are WITHOUT ANY WARRANTY; without even the implied warranty of MERCHANTABILITY AND FITNESS FOR A PARTICULAR PURPOSE.

List of libjpeg programs

libjpeg-6b

License terms of conditions of each program which are provided by owner of the copyright to the "libjpeg" are as follows.

Copyright (C) 1994-1997, Thomas G. Lane.

This file is part of the Independent JPEG Group's software.

For conditions of distribution and use, see the accompanying README file.

This distribution contains the sixth public release of the Independent JPEG Group's free JPEG software. You are welcome to redistribute this software and to use it for any purpose, subject to the conditions under LEGAL ISSUES, below.

LEGAL ISSUES

=====

In plain English:

1. We don't promise that this software works. (But if you find any bugs, please let us know!)

2. You can use this software for whatever you want. You don't have to pay us.
3. You may not pretend that you wrote this software. If you use it in a program, you must acknowledge somewhere in your documentation that you've used the IJG code.

In legalese:

The authors make NO WARRANTY or representation, either express or implied, with respect to this software, its quality, accuracy, merchantability, or fitness for a particular purpose. This software is provided "AS IS", and you, its user, assume the entire risk as to its quality and accuracy.

This software is copyright (C) 1991-1998, Thomas G. Lane.

All Rights Reserved except as specified below.

Permission is hereby granted to use, copy, modify, and distribute this software (or portions thereof) for any purpose, without fee, subject to these conditions:

(1) If any part of the source code for this software is distributed, then this README file must be included, with this copyright and no-warranty notice unaltered; and any additions, deletions, or changes to the original files must be clearly indicated in accompanying documentation.

(2) If only executable code is distributed, then the accompanying documentation must state that "this software is based in part on the work of the Independent JPEG Group".

(3) Permission for use of this software is granted only if the user accepts full responsibility for any undesirable consequences; the authors accept NO LIABILITY for damages of any kind.

These conditions apply to any software derived from or based on the IJG code, not just to the unmodified library. If you use our work, you ought to acknowledge us.

Permission is NOT granted for the use of any IJG author's name or company name in advertising or publicity relating to this software or products derived from it. This software may be referred to only as "the Independent JPEG Group's software".

We specifically permit and encourage the use of this software as the basis of commercial products, provided that all warranty or liability claims are assumed by the product vendor.

ansi2knr.c is included in this distribution by permission of L. Peter Deutsch, sole proprietor of its copyright holder, Aladdin Enterprises of Menlo Park, CA. ansi2knr.c is NOT covered by the above copyright and conditions, but instead by the usual distribution terms of the Free Software Foundation; principally, that you must include source code if you redistribute it. (See the file ansi2knr.c for full details.) However, since ansi2knr.c is not needed as part of any program generated from the IJG code, this does not limit you more than the foregoing paragraphs do.

The Unix configuration script "configure" was produced with GNU Autoconf. It is copyright by the Free Software Foundation but is freely distributable. The same holds for its supporting scripts (config.guess,

config.sub, ltconfig, ltmain.sh). Another support script, install-sh, is copyright by M.I.T. but is also freely distributable.

It appears that the arithmetic coding option of the JPEG spec is covered by patents owned by IBM, AT&T, and Mitsubishi. Hence arithmetic coding cannot legally be used without obtaining one or more licenses. For this reason, support for arithmetic coding has been removed from the free JPEG software. (Since arithmetic coding provides only a marginal gain over the unpatented Huffman mode, it is unlikely that very many implementations will support it.) So far as we are aware, there are no patent restrictions on the remaining code.

The IJG distribution formerly included code to read and write GIF files. To avoid entanglement with the Unisys LZW patent, GIF reading support has been removed altogether, and the GIF writer has been simplified to produce "uncompressed GIFs". This technique does not use the LZW algorithm; the resulting GIF files are larger than usual, but are readable by all standard GIF decoders.

We are required to state that "The Graphics Interchange Format(c) is the Copyright property of CompuServe Incorporated. GIF(sm) is a Service Mark property of CompuServe Incorporated."

libpng

This projector product includes the open source software program "libpng" which applies the terms and conditions provided by owner of the copyright to the "libpng".

The "libpng" are WITHOUT ANY WARRANTY; without even the implied warranty of MERCHANTABILITY AND FITNESS FOR A PARTICULAR PURPOSE.

List of libpng programs

libpng-1.2.7

License terms of conditions of each program which are provided by owner of the copyright to the "libpng" are as follows.

For conditions of distribution and use, see copyright notice in png.h

Copyright (c) 1998-2004 Glenn Randers-Pehrson

(Version 0.96 Copyright (c) 1996, 1997 Andreas Dilger)

(Version 0.88 Copyright (c) 1995, 1996 Guy Eric Schalnat, Group 42, Inc.)

This copy of the libpng notices is provided for your convenience. In case of any discrepancy between this copy and the notices in the file png.h that is included in the libpng distribution, the latter shall prevail.

COPYRIGHT NOTICE, DISCLAIMER, and LICENSE:

If you modify libpng you may insert additional notices immediately following this sentence.

libpng version 1.2.6, September 12, 2004 , is Copyright (c) 2004 Glenn Randers -Pehrson, and is distributed according to the same disclaimer and license as libpng-1.2.5 with the following individual added to the list of Contributing Authors

Cosmin Truta

libpng versions 1.0.7, July 1, 2000 , through 1.2.5 - October 3, 2002 , are Copyright (c) 2000-2002 Glenn Randers-Pehrson, and are distributed according to the same disclaimer and license as libpng-1.0.6 with the following individuals added to the list of Contributing Authors

Simon-Pierre Cadieux

Eric S. Raymond

Gilles Vollant

and with the following additions to the disclaimer:

There is no warranty against interference with your enjoyment of the library or against infringement. There is no warranty that our efforts or the library will fulfill any of your particular purposes or needs. This library is provided with all faults, and the entire risk of satisfactory quality, performance, accuracy, and effort is with the user.

libpng versions 0.97, January 1998, through 1.0.6, March 20, 2000 , are Copyright (c) 1998, 1999 Glenn Randers-Pehrson, and are distributed according to the same disclaimer and license as libpng-0.96, with the following individuals added to the list of Contributing Authors:

Tom Lane

Glenn Randers-Pehrson

Willem van Schaik

libpng versions 0.89, June 1996, through 0.96, May 1997, are Copyright (c) 1996, 1997 Andreas Dilger Distributed according to the same disclaimer and license as libpng-0.88, with the following individuals added to the list of Contributing Authors:

John Bowler

Kevin Bracey

Sam Bushell

Magnus Holmgren

Greg Roelofs

Tom Tanner

libpng versions 0.5, May 1995, through 0.88, January 1996, are Copyright (c) 1995, 1996 Guy Eric Schalnat, Group 42, Inc.

For the purposes of this copyright and license, "Contributing Authors" is defined as the following set of individuals:

Andreas Dilger

Dave Martindale

Guy Eric Schalnat

Paul Schmidt

Tim Wegner

The PNG Reference Library is supplied "AS IS". The Contributing Authors and Group 42, Inc. disclaim all warranties, expressed or implied, including, without limitation, the warranties of merchantability and of fitness for any purpose. The Contributing Authors and Group 42, Inc. assume no liability for direct, indirect, incidental, special, exemplary, or consequential damages, which may result from the use of the PNG Reference Library, even if advised of the possibility of such damage.

Permission is hereby granted to use, copy, modify, and distribute this source code, or portions hereof, for any purpose, without fee, subject to the following restrictions:

1. The origin of this source code must not be misrepresented.
2. Altered versions must be plainly marked as such and must not be misrepresented as being the original source.
3. This Copyright notice may not be removed or altered from any source or altered source distribution.

The Contributing Authors and Group 42, Inc. specifically permit, without fee, and encourage the use of this source code as a component to supporting the PNG file format in commercial products. If you use this source code in a product, acknowledgment is not required but would be appreciated.

A "png_get_copyright" function is available, for convenient use in "about" boxes and the like:

```
printf("%s",png_get_copyright(NULL));
```

Also, the PNG logo (in PNG format, of course) is supplied in the files "pngbar.png" and "pngbar.jpg" (88x31) and "pngnow.png" (98x31).

Libpng is OSI Certified Open Source Software. OSI Certified Open Source is a certification mark of the Open Source Initiative.

Glenn Randers-Pehrson

glennrp@users.sourceforge.net

September 12, 2004

zlib

This projector product includes the open source software program "zlib" which applies the terms and conditions provided by owner of the copyright to the "zlib".

The "zlib" are WITHOUT ANY WARRANTY; without even the implied warranty of MERCHANTABILITY AND FITNESS FOR A PARTICULAR PURPOSE.

List of zlib programs

zlib-1.1.4

License terms of conditions of each program which are provided by owner of the copyright to the "zlib" are as follows.

Copyright notice:

(C) 1995-1998 Jean-loup Gailly and Mark Adler

This software is provided 'as-is', without any express or implied warranty. In no event will the authors be held liable for any damages arising from the use of this software. Permission is granted to anyone to use this software for any purpose, including commercial applications, and to alter it and redistribute it freely, subject to the following restrictions:

1. The origin of this software must not be misrepresented; you must not claim that you wrote the original software. If you use this software in a product, an acknowledgment in the product documentation would be appreciated but is not required.
2. Altered source versions must be plainly marked as such, and must not be misrepresented as being the original software.
3. This notice may not be removed or altered from any source distribution.

Jean-loup Gailly Mark Adler

jloup@gzip.org madler@alumni.caltech.edu

If you use the zlib library in a product, we would appreciate *not* receiving lengthy legal documents to sign. The sources are provided for free but without warranty of any kind. The library has been entirely written by Jean-loup Gailly and Mark Adler; it does not include third-party code.

If you redistribute modified sources, we would appreciate that you include in the file ChangeLog history information documenting your changes.

mDNSResponder

This projector product includes the open source software program "mDNSResponder" which applies the following license terms "Apache License Version 2.0, January 2004".

List of "mDNSResponder"

mDNSResponder-107.6 (only mDNSResponderPosix is used)

License terms "Apache License Version 2.0, January 2004" are as follows.

Apache License

Version 2.0, January 2004

<http://www.apache.org/licenses/>

TERMS AND CONDITIONS FOR USE, REPRODUCTION, AND DISTRIBUTION

1. Definitions.

"License" shall mean the terms and conditions for use, reproduction, and distribution as defined by Sections 1 through 9 of this document.

"Licensor" shall mean the copyright owner or entity authorized by the copyright owner that is granting the License.

"Legal Entity" shall mean the union of the acting entity and all other entities that control, are controlled by, or are under common control with that entity. For the purposes of this definition, "control" means (i) the power, direct or indirect, to cause the direction or management of such entity, whether by contract or otherwise, or (ii) ownership of fifty percent (50%) or more of the outstanding shares, or (iii) beneficial ownership of such entity.

"You" (or "Your") shall mean an individual or Legal Entity exercising permissions granted by this License.

"Source" form shall mean the preferred form for making modifications, including but not limited to software source code, documentation source, and configuration files.

"Object" form shall mean any form resulting from mechanical transformation or translation of a Source form, including but not limited to compiled object code, generated documentation, and conversions to other media types.

"Work" shall mean the work of authorship, whether in Source or Object form, made available under the License, as indicated by a copyright notice that is included in or attached to the work (an example is provided in the Appendix below).

"Derivative Works" shall mean any work, whether in Source or Object form, that is based on (or derived from) the Work and for which the editorial revisions, annotations, elaborations, or other modifications represent, as a whole, an original work of authorship. For the purposes of this License, Derivative Works shall not include works that remain separable from, or merely link (or bind by name) to the interfaces of, the Work and Derivative Works thereof.

"Contribution" shall mean any work of authorship, including the original version of the Work and any modifications or additions to that Work or Derivative Works thereof, that is intentionally submitted to Licensor for inclusion in the Work by the copyright owner or by an individual or Legal Entity authorized to submit on behalf of the copyright owner. For the purposes of this definition, "submitted" means any form

of electronic, verbal, or written communication sent to the Licensor or its representatives, including but not limited to communication on electronic mailing lists, source code control systems, and issue tracking systems that are managed by, or on behalf of, the Licensor for the purpose of discussing and improving the Work, but excluding communication that is conspicuously marked or otherwise designated in writing by the copyright owner as "Not a Contribution."

"Contributor" shall mean Licensor and any individual or Legal Entity on behalf of whom a Contribution has been received by Licensor and subsequently incorporated within the Work.

2. Grant of Copyright License. Subject to the terms and conditions of this License, each Contributor hereby grants to You a perpetual, worldwide, non-exclusive, no-charge, royalty-free, irrevocable copyright license to reproduce, prepare Derivative Works of, publicly display, publicly perform, sublicense, and distribute the Work and such Derivative Works in Source or Object form.

3. Grant of Patent License. Subject to the terms and conditions of this License, each Contributor hereby grants to You a perpetual, worldwide, non-exclusive, no-charge, royalty-free, irrevocable (except as stated in this section) patent license to make, have made, use, offer to sell, sell, import, and otherwise transfer the Work, where such license applies only to those patent claims licensable by such Contributor that are necessarily infringed by their Contribution(s) alone or by combination of their Contribution(s) with the Work to which such Contribution(s) was submitted. If You institute patent litigation against any entity (including a cross-claim or counterclaim in a lawsuit) alleging that the Work or a Contribution incorporated within the Work constitutes direct or contributory patent infringement, then any patent licenses granted to You under this License for that Work shall terminate as of the date such litigation is filed.

4. Redistribution. You may reproduce and distribute copies of the Work or Derivative Works thereof in any medium, with or without modifications, and in Source or Object form, provided that You meet the following conditions:

(a) You must give any other recipients of the Work or Derivative Works a copy of this License; and

(b) You must cause any modified files to carry prominent notices stating that You changed the files; and

(c) You must retain, in the Source form of any Derivative Works that You distribute, all copyright, patent, trademark, and attribution notices from the Source form of the Work, excluding those notices that do not pertain to any part of the Derivative Works; and

(d) If the Work includes a "NOTICE" text file as part of its distribution, then any Derivative Works that You distribute must include a readable copy of the attribution notices contained within such NOTICE file, excluding those notices that do not pertain to any part of the Derivative Works, in at least one of the following places: within a NOTICE text file distributed as part of the Derivative Works; within the Source form or documentation, if provided along with the Derivative Works; or, within a display generated by the Derivative Works, if and wherever such third-party notices normally appear. The contents of the NOTICE file are for informational purposes only and do not modify the License. You may add Your own attribution notices within Derivative Works that You distribute, alongside or as an addendum to the NOTICE text

from the Work, provided that such additional attribution notices cannot be construed as modifying the License.

You may add Your own copyright statement to Your modifications and may provide additional or different license terms and conditions for use, reproduction, or distribution of Your modifications, or for any such Derivative Works as a whole, provided Your use, reproduction, and distribution of the Work otherwise complies with the conditions stated in this License.

5. Submission of Contributions. Unless You explicitly state otherwise, any Contribution intentionally submitted for inclusion in the Work by You to the Licensor shall be under the terms and conditions of this License, without any additional terms or conditions. Notwithstanding the above, nothing herein shall supersede or modify the terms of any separate license agreement you may have executed with Licensor regarding such Contributions.

6. Trademarks. This License does not grant permission to use the trade names, trademarks, service marks, or product names of the Licensor, except as required for reasonable and customary use in describing the origin of the Work and reproducing the content of the NOTICE file.

7. Disclaimer of Warranty. Unless required by applicable law or agreed to in writing, Licensor provides the Work (and each Contributor provides its Contributions) on an "AS IS" BASIS, WITHOUT WARRANTIES OR CONDITIONS OF ANY KIND, either express or implied, including, without limitation, any warranties or conditions of TITLE, NON-INFRINGEMENT, MERCHANTABILITY, or FITNESS FOR A PARTICULAR PURPOSE. You are solely responsible for determining the appropriateness of using or redistributing the Work and assume any risks associated with Your exercise of permissions under this License.

8. Limitation of Liability. In no event and under no legal theory, whether in tort (including negligence), contract, or otherwise, unless required by applicable law (such as deliberate and grossly negligent acts) or agreed to in writing, shall any Contributor be liable to You for damages, including any direct, indirect, special, incidental, or consequential damages of any character arising as a result of this License or out of the use or inability to use the Work (including but not limited to damages for loss of goodwill, work stoppage, computer failure or malfunction, or any and all other commercial damages or losses), even if such Contributor has been advised of the possibility of such damages.

9. Accepting Warranty or Additional Liability. While redistributing the Work or Derivative Works thereof, You may choose to offer, and charge a fee for, acceptance of support, warranty, indemnity, or other liability obligations and/or rights consistent with this License. However, in accepting such obligations, You may act only on Your own behalf and on Your sole responsibility, not on behalf of any other Contributor, and only if You agree to indemnify, defend, and hold each Contributor harmless for any liability incurred by, or claims asserted against, such Contributor by reason of your accepting any such warranty or additional liability.

END OF TERMS AND CONDITIONS

APPENDIX: How to apply the Apache License to your work.

To apply the Apache License to your work, attach the following boilerplate notice, with the fields enclosed by brackets "[]" replaced with your own identifying information. (Don't include the brackets!) The text should be enclosed in the appropriate comment syntax for the file format. We also recommend that a file or class name and description of purpose be included on the same "printed page" as the copyright notice for easier identification within third-party archives.

Copyright [yyyy] [name of copyright owner]

Licensed under the Apache License, Version 2.0 (the "License"); you may not use this file except in compliance with the License.

You may obtain a copy of the License at

<http://www.apache.org/licenses/LICENSE-2.0>

Unless required by applicable law or agreed to in writing, software distributed under the License is distributed on an "AS IS" BASIS, WITHOUT WARRANTIES OR CONDITIONS OF ANY KIND, either express or implied.

See the License for the specific language governing permissions and limitations under the License.

aes-src-29-04-09

This projector product includes the open source software program "aes-src-29-04-09" which applies the terms and conditions provided by owner of the copyright to the "aessrc-29-04-09".

The "aes-src-29-04-09" are WITHOUT ANY WARRANTY; without even the implied warranty of MERCHANTABILITY AND FITNESS FOR A PARTICULAR PURPOSE.

List of aes-src-29-04-09 programs

aes-src-29-04-09

License terms of conditions of each program which are provided by owner of the copyright to the "aes-src-29-04-09" are as follows.

Copyright (c) 1998-2008, Brian Gladman, Worcester , UK . All rights reserved.

LICENSE TERMS

The redistribution and use of this software (with or without changes) is allowed without the payment of fees or royalties provided that:

1. source code distributions include the above copyright notice, this list of conditions and the following disclaimer;
2. binary distributions include the above copyright notice, this list of conditions and the following disclaimer in their documentation;

3. the name of the copyright holder is not used to endorse products built using this software without specific written permission.

DISCLAIMER

This software is provided 'as is' with no explicit or implied warranties in respect of its properties, including, but not limited to, correctness and/or fitness for purpose.

newlib

This projector product includes the open source software program "newlib" which applies the terms and conditions provided by owner of the copyright to the "newlib".

The "newlib" are WITHOUT ANY WARRANTY; without even the implied warranty of MERCHANTABILITY AND FITNESS FOR A PARTICULAR PURPOSE.

List of newlib programs

newlib 1.17.0

License terms of conditions of each program which are provided by owner of the copyright to the "newlib" are as follows.

The newlib subdirectory is a collection of software from several sources.

Each file may have its own copyright/license that is embedded in the source file. Unless otherwise noted in the body of the source file(s), the following copyright notices will apply to the contents of the newlib subdirectory:

(1) Red Hat Incorporated

Copyright (c) 1994-2007 Red Hat, Inc. All rights reserved.

This copyrighted material is made available to anyone wishing to use, modify, copy, or redistribute it subject to the terms and conditions of the BSD License. This program is distributed in the hope that it will be useful, but WITHOUT ANY WARRANTY expressed or implied, including the implied warranties of MERCHANTABILITY or FITNESS FOR A PARTICULAR PURPOSE. A copy of this license is available at <http://www.opensource.org/licenses>. Any Red Hat trademarks that are incorporated in the source code or documentation are not subject to the BSD License and may only be used or replicated with the express permission of Red Hat, Inc.

(2) University of California , Berkeley

Copyright (c) 1981-2000 The Regents of the University of California .

All rights reserved.

Redistribution and use in source and binary forms, with or without modification, are permitted provided that the following conditions are met:

* Redistributions of source code must retain the above copyright notice, this list of conditions and the following disclaimer.

* Redistributions in binary form must reproduce the above copyright notice, this list of conditions and the following disclaimer in the documentation and/or other materials provided with the distribution.

* Neither the name of the University nor the names of its contributors may be used to endorse or promote products derived from this software without specific prior written permission.

THIS SOFTWARE IS PROVIDED BY THE COPYRIGHT HOLDERS AND CONTRIBUTORS "AS IS" AND ANY EXPRESS OR IMPLIED WARRANTIES, INCLUDING, BUT NOT LIMITED TO, THE IMPLIED WARRANTIES OF MERCHANTABILITY AND FITNESS FOR A PARTICULAR PURPOSE ARE DISCLAIMED. IN NO EVENT SHALL THE COPYRIGHT OWNER OR CONTRIBUTORS BE LIABLE FOR ANY DIRECT, INDIRECT, INCIDENTAL, SPECIAL, EXEMPLARY, OR CONSEQUENTIAL DAMAGES (INCLUDING, BUT NOT LIMITED TO, PROCUREMENT OF SUBSTITUTE GOODS OR SERVICES; LOSS OF USE, DATA, OR PROFITS; OR BUSINESS INTERRUPTION) HOWEVER CAUSED AND ON ANY THEORY OF LIABILITY, WHETHER IN CONTRACT, STRICT LIABILITY, OR TORT (INCLUDING NEGLIGENCE OR OTHERWISE) ARISING IN ANY WAY OUT OF THE USE OF THIS SOFTWARE, EVEN IF ADVISED OF THE POSSIBILITY OF SUCH DAMAGE.

(3) David M. Gay (AT&T 1991, Lucent 1998)

The author of this software is David M. Gay.

Copyright (c) 1991 by AT&T.

Permission to use, copy, modify, and distribute this software for any purpose without fee is hereby granted, provided that this entire notice is included in all copies of any software which is or includes a copy or modification of this software and in all copies of the supporting documentation for such software.

THIS SOFTWARE IS BEING PROVIDED "AS IS", WITHOUT ANY EXPRESS OR IMPLIED WARRANTY. IN PARTICULAR, NEITHER THE AUTHOR NOR AT&T MAKES ANY REPRESENTATION OR WARRANTY OF ANY KIND CONCERNING THE MERCHANTABILITY OF THIS SOFTWARE OR ITS FITNESS FOR ANY PARTICULAR PURPOSE.

The author of this software is David M. Gay.

Copyright (C) 1998-2001 by Lucent Technologies

All Rights Reserved

Permission to use, copy, modify, and distribute this software and its documentation for any purpose and without fee is hereby granted, provided that the above copyright notice appear in all copies and that both that the copyright notice and this permission notice and warranty disclaimer appear in supporting documentation, and that the name of Lucent or any of its entities not be used in advertising or publicity pertaining to distribution of the software without specific, written prior permission.

LUCENT DISCLAIMS ALL WARRANTIES WITH REGARD TO THIS SOFTWARE, INCLUDING ALL IMPLIED WARRANTIES OF MERCHANTABILITY AND FITNESS. IN NO EVENT SHALL LUCENT OR ANY OF ITS ENTITIES BE LIABLE FOR ANY SPECIAL, INDIRECT OR CONSEQUENTIAL DAMAGES OR ANY DAMAGES WHATSOEVER RESULTING FROM LOSS OF USE, DATA OR PROFITS, WHETHER IN AN ACTION OF CONTRACT, NEGLIGENCE OR OTHER TORTIOUS ACTION, ARISING OUT OF OR IN CONNECTION WITH THE USE OR PERFORMANCE OF THIS SOFTWARE.

(4) Advanced Micro Devices

Copyright 1989, 1990 Advanced Micro Devices, Inc.

This software is the property of Advanced Micro Devices, Inc (AMD) which specifically grants the user the right to modify, use and distribute this software provided this notice is not removed or altered. All other rights are reserved by AMD.

AMD MAKES NO WARRANTY OF ANY KIND, EXPRESS OR IMPLIED, WITH REGARD TO THIS SOFTWARE. IN NO EVENT SHALL AMD BE LIABLE FOR INCIDENTAL OR CONSEQUENTIAL DAMAGES IN CONNECTION WITH OR ARISING FROM THE FURNISHING, PERFORMANCE, OR USE OF THIS SOFTWARE.

So that all may benefit from your experience, please report any problems or suggestions about this software to the 29K Technical Support Center at 800-29-29-AMD (800-292-9263) in the USA , or 0800-89-1131 in the UK, or 0031-11-1129 in Japan, toll free. The direct dial number is 512-462-4118.

Advanced Micro Devices, Inc.

29K Support Products

Mail Stop 573

5900 E. Ben White Blvd.

Austin , TX 78741

800-292-9263

(5) C.W. Sandmann

Copyright (C) 1993 C.W. Sandmann

This file may be freely distributed as long as the author's name remains.

(6) Eric Backus

(C) Copyright 1992 Eric Backus

This software may be used freely so long as this copyright notice is left intact. There is no warrantee on this software.

(7) Sun Microsystems

Copyright (C) 1993 by Sun Microsystems, Inc. All rights reserved.

Developed at SunPro, a Sun Microsystems, Inc. business. Permission to use, copy, modify, and distribute this software is freely granted, provided that this notice is preserved.

(8) Hewlett Packard

(c) Copyright 1986 HEWLETT-PACKARD COMPANY

To anyone who acknowledges that this file is provided "AS IS" without any express or implied warranty: permission to use, copy, modify, and distribute this file for any purpose is hereby granted without fee, provided that the above copyright notice and this notice appears in all copies, and that the name of Hewlett-Packard Company not be used in advertising or publicity pertaining to distribution of the software without specific, written prior permission. Hewlett-Packard Company makes no representations about the suitability of this software for any purpose.

(9) Hans-Peter Nilsson

Copyright (C) 2001 Hans-Peter Nilsson

Permission to use, copy, modify, and distribute this software is freely granted, provided that the above copyright notice, this notice and the following disclaimer are preserved with no changes.

THIS SOFTWARE IS PROVIDED "AS IS" AND WITHOUT ANY EXPRESS OR IMPLIED WARRANTIES, INCLUDING, WITHOUT LIMITATION, THE IMPLIED WARRANTIES OF MERCHANTABILITY AND FITNESS FOR A PARTICULAR PURPOSE.

(11) Christopher G. Demetriou

Copyright (c) 2001 Christopher G. Demetriou

All rights reserved.

Redistribution and use in source and binary forms, with or without modification, are permitted provided that the following conditions are met:

1. Redistributions of source code must retain the above copyright notice, this list of conditions and the following disclaimer.
2. Redistributions in binary form must reproduce the above copyright notice, this list of conditions and the following disclaimer in the documentation and/or other materials provided with the distribution.
3. The name of the author may not be used to endorse or promote products derived from this software without specific prior written permission.

THIS SOFTWARE IS PROVIDED BY THE AUTHOR "AS IS" AND ANY EXPRESS OR IMPLIED WARRANTIES, INCLUDING, BUT NOT LIMITED TO, THE IMPLIED WARRANTIES OF MERCHANTABILITY AND FITNESS FOR A PARTICULAR PURPOSE ARE DISCLAIMED. IN NO EVENT SHALL THE AUTHOR BE LIABLE FOR ANY DIRECT, INDIRECT, INCIDENTAL, SPECIAL,

EXEMPLARY, OR CONSEQUENTIAL DAMAGES (INCLUDING, BUT NOT LIMITED TO, PROCUREMENT OF SUBSTITUTE GOODS OR SERVICES; LOSS OF USE, DATA, OR PROFITS; OR BUSINESS INTERRUPTION) HOWEVER CAUSED AND ON ANY THEORY OF LIABILITY, WHETHER IN CONTRACT, STRICT LIABILITY, OR TORT (INCLUDING NEGLIGENCE OR OTHERWISE) ARISING IN ANY WAY OUT OF THE USE OF THIS SOFTWARE, EVEN IF ADVISED OF THE POSSIBILITY OF SUCH DAMAGE.

(12) SuperH, Inc.

Copyright 2002 SuperH, Inc. All rights reserved

This software is the property of SuperH, Inc (SuperH) which specifically grants the user the right to modify, use and distribute this software provided this notice is not removed or altered. All other rights are reserved by SuperH.

SUPERH MAKES NO WARRANTY OF ANY KIND, EXPRESS OR IMPLIED, WITH REGARD TO THIS SOFTWARE. IN NO EVENT SHALL SUPERH BE LIABLE FOR INDIRECT, SPECIAL, INCIDENTAL OR CONSEQUENTIAL DAMAGES IN CONNECTION WITH OR ARISING FROM THE FURNISHING, PERFORMANCE, OR USE OF THIS SOFTWARE.

So that all may benefit from your experience, please report any problems or suggestions about this software to the SuperH Support Center via e-mail at softwaresupport@superh.com.

SuperH, Inc.

405 River

Oaks Parkway

San Jose

CA 95134

USA

(13) Royal Institute of Technology

Copyright (c) 1999 Kungliga Tekniska Högskolan

(Royal Institute of Technology , Stockholm , Sweden).

All rights reserved.

Redistribution and use in source and binary forms, with or without modification, are permitted provided that the following conditions are met:

1. Redistributions of source code must retain the above copyright notice, this list of conditions and the following disclaimer.

2. Redistributions in binary form must reproduce the above copyright notice, this list of conditions and the following disclaimer in the documentation and/or other materials provided with the distribution.

3. Neither the name of KTH nor the names of its contributors may be used to endorse or promote products derived from this software without specific prior written permission.

THIS SOFTWARE IS PROVIDED BY KTH AND ITS CONTRIBUTORS "AS IS" AND ANY EXPRESS OR IMPLIED WARRANTIES, INCLUDING, BUT NOT LIMITED TO, THE IMPLIED WARRANTIES OF MERCHANTABILITY AND FITNESS FOR A PARTICULAR PURPOSE ARE DISCLAIMED. IN NO EVENT SHALL KTH OR ITS CONTRIBUTORS BE LIABLE FOR ANY DIRECT, INDIRECT, INCIDENTAL, SPECIAL, EXEMPLARY, OR CONSEQUENTIAL DAMAGES (INCLUDING, BUT NOT LIMITED TO, PROCUREMENT OF SUBSTITUTE GOODS OR SERVICES; LOSS OF USE, DATA, OR PROFITS; OR BUSINESS INTERRUPTION) HOWEVER CAUSED AND ON ANY THEORY OF LIABILITY, WHETHER IN CONTRACT, STRICT LIABILITY, OR TORT (INCLUDING NEGLIGENCE OR OTHERWISE) ARISING IN ANY WAY OUT OF THE USE OF THIS SOFTWARE, EVEN IF ADVISED OF THE POSSIBILITY OF SUCH DAMAGE.

(14) Alexey Zelkin

Copyright (c) 2000, 2001 Alexey Zelkin <phantom@FreeBSD.org>

All rights reserved.

Redistribution and use in source and binary forms, with or without modification, are permitted provided that the following conditions are met:

1. Redistributions of source code must retain the above copyright notice, this list of conditions and the following disclaimer.

2. Redistributions in binary form must reproduce the above copyright notice, this list of conditions and the following disclaimer in the documentation and/or other materials provided with the distribution.

THIS SOFTWARE IS PROVIDED BY THE AUTHOR AND CONTRIBUTORS "AS IS" AND ANY EXPRESS OR IMPLIED WARRANTIES, INCLUDING, BUT NOT LIMITED TO, THE IMPLIED WARRANTIES OF MERCHANTABILITY AND FITNESS FOR A PARTICULAR PURPOSE ARE DISCLAIMED. IN NO EVENT SHALL THE AUTHOR OR CONTRIBUTORS BE LIABLE FOR ANY DIRECT, INDIRECT, INCIDENTAL, SPECIAL, EXEMPLARY, OR CONSEQUENTIAL DAMAGES (INCLUDING, BUT NOT LIMITED TO, PROCUREMENT OF SUBSTITUTE GOODS OR SERVICES; LOSS OF USE, DATA, OR PROFITS; OR BUSINESS INTERRUPTION) HOWEVER CAUSED AND ON ANY THEORY OF LIABILITY, WHETHER IN CONTRACT, STRICT LIABILITY, OR TORT (INCLUDING NEGLIGENCE OR OTHERWISE) ARISING IN ANY WAY OUT OF THE USE OF THIS SOFTWARE, EVEN IF ADVISED OF THE POSSIBILITY OF SUCH DAMAGE.

(15) Andrey A. Chernov

Copyright (C) 1997 by Andrey A. Chernov, Moscow , Russia .

All rights reserved.

Redistribution and use in source and binary forms, with or without modification, are permitted provided that the following conditions are met:

1. Redistributions of source code must retain the above copyright notice, this list of conditions and the following disclaimer.
2. Redistributions in binary form must reproduce the above copyright notice, this list of conditions and the following disclaimer in the documentation and/or other materials provided with the distribution.

THIS SOFTWARE IS PROVIDED BY THE AUTHOR "AS IS" AND ANY EXPRESS OR IMPLIED WARRANTIES, INCLUDING, BUT NOT LIMITED TO, THE IMPLIED WARRANTIES OF MERCHANTABILITY AND FITNESS FOR A PARTICULAR PURPOSE ARE DISCLAIMED. IN NO EVENT SHALL THE REGENTS OR CONTRIBUTORS BE LIABLE FOR ANY DIRECT, INDIRECT, INCIDENTAL, SPECIAL, EXEMPLARY, OR CONSEQUENTIAL DAMAGES (INCLUDING, BUT NOT LIMITED TO, PROCUREMENT OF SUBSTITUTE GOODS OR SERVICES; LOSS OF USE, DATA, OR PROFITS; OR BUSINESS INTERRUPTION) HOWEVER CAUSED AND ON ANY THEORY OF LIABILITY, WHETHER IN CONTRACT, STRICT LIABILITY, OR TORT (INCLUDING NEGLIGENCE OR OTHERWISE) ARISING IN ANY WAY OUT OF THE USE OF THIS SOFTWARE, EVEN IF ADVISED OF THE POSSIBILITY OF SUCH DAMAGE.

(16) FreeBSD

Copyright (c) 1997-2002 FreeBSD Project.

All rights reserved.

Redistribution and use in source and binary forms, with or without modification, are permitted provided that the following conditions are met:

1. Redistributions of source code must retain the above copyright notice, this list of conditions and the following disclaimer.
2. Redistributions in binary form must reproduce the above copyright notice, this list of conditions and the following disclaimer in the documentation and/or other materials provided with the distribution.

THIS SOFTWARE IS PROVIDED BY THE AUTHOR AND CONTRIBUTORS "AS IS" AND ANY EXPRESS OR IMPLIED WARRANTIES, INCLUDING, BUT NOT LIMITED TO, THE IMPLIED WARRANTIES OF MERCHANTABILITY AND FITNESS FOR A PARTICULAR PURPOSE ARE DISCLAIMED. IN NO EVENT SHALL THE AUTHOR OR CONTRIBUTORS BE LIABLE FOR ANY DIRECT, INDIRECT, INCIDENTAL, SPECIAL, EXEMPLARY, OR CONSEQUENTIAL DAMAGES (INCLUDING, BUT NOT LIMITED TO, PROCUREMENT OF SUBSTITUTE GOODS OR SERVICES; LOSS OF USE, DATA, OR PROFITS; OR BUSINESS INTERRUPTION) HOWEVER CAUSED AND ON ANY THEORY OF LIABILITY, WHETHER IN CONTRACT, STRICT LIABILITY, OR TORT (INCLUDING NEGLIGENCE OR OTHERWISE) ARISING IN ANY WAY OUT OF THE USE OF THIS SOFTWARE, EVEN IF ADVISED OF THE POSSIBILITY OF SUCH DAMAGE.

(17) S. L. Moshier

Author: S. L. Moshier.

Copyright (c) 1984,2000 S.L. Moshier

Permission to use, copy, modify, and distribute this software for any purpose without fee is hereby granted, provided that this entire notice is included in all copies of any software which is or includes a copy or modification of this software and in all copies of the supporting documentation for such software.

THIS SOFTWARE IS BEING PROVIDED "AS IS", WITHOUT ANY EXPRESS OR IMPLIED WARRANTY. IN PARTICULAR, THE AUTHOR MAKES NO REPRESENTATION OR WARRANTY OF ANY KIND CONCERNING THE MERCHANTABILITY OF THIS SOFTWARE OR ITS FITNESS FOR ANY PARTICULAR PURPOSE.

(18) Citrus Project

Copyright (c)1999 Citrus Project,

All rights reserved.

Redistribution and use in source and binary forms, with or without modification, are permitted provided that the following conditions are met:

1. Redistributions of source code must retain the above copyright notice, this list of conditions and the following disclaimer.
2. Redistributions in binary form must reproduce the above copyright notice, this list of conditions and the following disclaimer in the documentation and/or other materials provided with the distribution.

THIS SOFTWARE IS PROVIDED BY THE AUTHOR AND CONTRIBUTORS "AS IS" AND ANY EXPRESS OR IMPLIED WARRANTIES, INCLUDING, BUT NOT LIMITED TO, THE IMPLIED WARRANTIES OF MERCHANTABILITY AND FITNESS FOR A PARTICULAR PURPOSE ARE DISCLAIMED. IN NO EVENT SHALL THE AUTHOR OR CONTRIBUTORS BE LIABLE FOR ANY DIRECT, INDIRECT, INCIDENTAL, SPECIAL, EXEMPLARY, OR CONSEQUENTIAL DAMAGES (INCLUDING, BUT NOT LIMITED TO, PROCUREMENT OF SUBSTITUTE GOODS OR SERVICES; LOSS OF USE, DATA, OR PROFITS; OR BUSINESS INTERRUPTION) HOWEVER CAUSED AND ON ANY THEORY OF LIABILITY, WHETHER IN CONTRACT, STRICT LIABILITY, OR TORT (INCLUDING NEGLIGENCE OR OTHERWISE) ARISING IN ANY WAY OUT OF THE USE OF THIS SOFTWARE, EVEN IF ADVISED OF THE POSSIBILITY OF SUCH DAMAGE.

(19) Todd C. Miller

Copyright (c) 1998 Todd C. Miller <Todd.Miller@courtesan.com>

All rights reserved.

Redistribution and use in source and binary forms, with or without modification, are permitted provided that the following conditions are met:

1. Redistributions of source code must retain the above copyright notice, this list of conditions and the following disclaimer.
2. Redistributions in binary form must reproduce the above copyright notice, this list of conditions and the following disclaimer in the documentation and/or other materials provided with the distribution.
3. The name of the author may not be used to endorse or promote products derived from this software without specific prior written permission.

THIS SOFTWARE IS PROVIDED "AS IS" AND ANY EXPRESS OR IMPLIED WARRANTIES, INCLUDING, BUT NOT LIMITED TO, THE IMPLIED WARRANTIES OF MERCHANTABILITY AND FITNESS FOR A PARTICULAR PURPOSE ARE DISCLAIMED. IN NO EVENT SHALL THE AUTHOR BE LIABLE FOR ANY DIRECT, INDIRECT, INCIDENTAL, SPECIAL, EXEMPLARY, OR CONSEQUENTIAL DAMAGES (INCLUDING, BUT NOT LIMITED TO, PROCUREMENT OF SUBSTITUTE GOODS OR SERVICES; LOSS OF USE, DATA, OR PROFITS; OR BUSINESS INTERRUPTION) HOWEVER CAUSED AND ON ANY THEORY OF LIABILITY, WHETHER IN CONTRACT, STRICT LIABILITY, OR TORT (INCLUDING NEGLIGENCE OR OTHERWISE) ARISING IN ANY WAY OUT OF THE USE OF THIS SOFTWARE, EVEN IF ADVISED OF THE POSSIBILITY OF SUCH DAMAGE.

(20) DJ Delorie (i386)

Copyright (C) 1991 DJ Delorie

All rights reserved.

Redistribution and use in source and binary forms is permitted provided that the above copyright notice and following paragraph are duplicated in all such forms.

This file is distributed WITHOUT ANY WARRANTY; without even the implied warranty of MERCHANTABILITY or FITNESS FOR A PARTICULAR PURPOSE.

(23) Intel (i960)

Copyright (c) 1993 Intel Corporation

Intel hereby grants you permission to copy, modify, and distribute this software and its documentation. Intel grants this permission provided that the above copyright notice appears in all copies and that both the copyright notice and this permission notice appear in supporting documentation. In addition, Intel grants this permission provided that you prominently mark as "not part of the original" any modifications made to this software or documentation, and that the name of Intel Corporation not be used in advertising or publicity pertaining to distribution of the software or the documentation without specific, written prior permission.

Intel Corporation provides this AS IS, WITHOUT ANY WARRANTY, EXPRESS OR IMPLIED, INCLUDING, WITHOUT LIMITATION, ANY WARRANTY OF MERCHANTABILITY OR FITNESS FOR A PARTICULAR PURPOSE. Intel makes no guarantee or representations regarding the use of, or the

results of the use of, the software and documentation in terms of correctness, accuracy, reliability, currentness, or otherwise; and you rely on the software, documentation and results solely at your own risk.

IN NO EVENT SHALL INTEL BE LIABLE FOR ANY LOSS OF USE, LOSS OF BUSINESS, LOSS OF PROFITS, INDIRECT, INCIDENTAL, SPECIAL OR CONSEQUENTIAL DAMAGES OF ANY KIND. IN NO EVENT SHALL INTEL'S TOTAL LIABILITY EXCEED THE SUM PAID TO INTEL FOR THE PRODUCT LICENSED HEREUNDER.

(26) Mike Barcroft

Copyright (c) 2001 Mike Barcroft <mike@FreeBSD.org>

All rights reserved.

Redistribution and use in source and binary forms, with or without modification, are permitted provided that the following conditions are met:

1. Redistributions of source code must retain the above copyright notice, this list of conditions and the following disclaimer.
2. Redistributions in binary form must reproduce the above copyright notice, this list of conditions and the following disclaimer in the documentation and/or other materials provided with the distribution.

THIS SOFTWARE IS PROVIDED BY THE AUTHOR AND CONTRIBUTORS "AS IS" AND ANY EXPRESS OR IMPLIED WARRANTIES, INCLUDING, BUT NOT LIMITED TO, THE IMPLIED WARRANTIES OF MERCHANTABILITY AND FITNESS FOR A PARTICULAR PURPOSE ARE DISCLAIMED. IN NO EVENT SHALL THE AUTHOR OR CONTRIBUTORS BE LIABLE FOR ANY DIRECT, INDIRECT, INCIDENTAL, SPECIAL, EXEMPLARY, OR CONSEQUENTIAL DAMAGES (INCLUDING, BUT NOT LIMITED TO, PROCUREMENT OF SUBSTITUTE GOODS OR SERVICES; LOSS OF USE, DATA, OR PROFITS; OR BUSINESS INTERRUPTION) HOWEVER CAUSED AND ON ANY THEORY OF LIABILITY, WHETHER IN CONTRACT, STRICT LIABILITY, OR TORT (INCLUDING NEGLIGENCE OR OTHERWISE) ARISING IN ANY WAY OUT OF THE USE OF THIS SOFTWARE, EVEN IF ADVISED OF THE POSSIBILITY OF SUCH DAMAGE.

(27) Konstantin Chuguev (--enable-newlib-iconv)

Copyright (c) 1999, 2000

Konstantin Chuguev. All rights reserved.

Redistribution and use in source and binary forms, with or without modification, are permitted provided that the following conditions are met:

1. Redistributions of source code must retain the above copyright notice, this list of conditions and the following disclaimer.

2. Redistributions in binary form must reproduce the above copyright notice, this list of conditions and the following disclaimer in the documentation and/or other materials provided with the distribution.

THIS SOFTWARE IS PROVIDED BY THE AUTHOR AND CONTRIBUTORS "AS IS" AND ANY EXPRESS OR IMPLIED WARRANTIES, INCLUDING, BUT NOT LIMITED TO, THE IMPLIED WARRANTIES OF MERCHANTABILITY AND FITNESS FOR A PARTICULAR PURPOSE ARE DISCLAIMED. IN NO EVENT SHALL THE AUTHOR OR CONTRIBUTORS BE LIABLE FOR ANY DIRECT, INDIRECT, INCIDENTAL, SPECIAL, EXEMPLARY, OR CONSEQUENTIAL DAMAGES (INCLUDING, BUT NOT LIMITED TO, PROCUREMENT OF SUBSTITUTE GOODS OR SERVICES; LOSS OF USE, DATA, OR PROFITS; OR BUSINESS INTERRUPTION) HOWEVER CAUSED AND ON ANY THEORY OF LIABILITY, WHETHER IN CONTRACT, STRICT LIABILITY, OR TORT (INCLUDING NEGLIGENCE OR OTHERWISE) ARISING IN ANY WAY OUT OF THE USE OF THIS SOFTWARE, EVEN IF ADVISED OF THE POSSIBILITY OF SUCH DAMAGE.

iconv (Charset Conversion Library) v2.0

(28) Artem Bityuckiy (--enable-newlib-iconv)

Copyright (c) 2003, Artem B. Bityuckiy, SoftMine Corporation.

Rights transferred to Franklin Electronic Publishers.

Redistribution and use in source and binary forms, with or without modification, are permitted provided that the following conditions are met:

1. Redistributions of source code must retain the above copyright notice, this list of conditions and the following disclaimer.

2. Redistributions in binary form must reproduce the above copyright notice, this list of conditions and the following disclaimer in the documentation and/or other materials provided with the distribution.

THIS SOFTWARE IS PROVIDED BY THE AUTHOR AND CONTRIBUTORS "AS IS" AND ANY EXPRESS OR IMPLIED WARRANTIES, INCLUDING, BUT NOT LIMITED TO, THE IMPLIED WARRANTIES OF MERCHANTABILITY AND FITNESS FOR A PARTICULAR PURPOSE ARE DISCLAIMED. IN NO EVENT SHALL THE AUTHOR OR CONTRIBUTORS BE LIABLE FOR ANY DIRECT, INDIRECT, INCIDENTAL, SPECIAL, EXEMPLARY, OR CONSEQUENTIAL DAMAGES (INCLUDING, BUT NOT LIMITED TO, PROCUREMENT OF SUBSTITUTE GOODS OR SERVICES; LOSS OF USE, DATA, OR PROFITS; OR BUSINESS INTERRUPTION) HOWEVER CAUSED AND ON ANY THEORY OF LIABILITY, WHETHER IN CONTRACT, STRICT LIABILITY, OR TORT (INCLUDING NEGLIGENCE OR OTHERWISE) ARISING IN ANY WAY OUT OF THE USE OF THIS SOFTWARE, EVEN IF ADVISED OF THE POSSIBILITY OF SUCH DAMAGE.

(30) - Alex Tatmanjants (targets using libc/posix)

Copyright (c) 1995 Alex Tatmanjants <alex@elvisti.kiev.ua>

at Electronni Visti IA, Kiev , Ukraine .

All rights reserved.

Redistribution and use in source and binary forms, with or without modification, are permitted provided that the following conditions are met:

1. Redistributions of source code must retain the above copyright notice, this list of conditions and the following disclaimer.
2. Redistributions in binary form must reproduce the above copyright notice, this list of conditions and the following disclaimer in the documentation and/or other materials provided with the distribution.

THIS SOFTWARE IS PROVIDED BY THE AUTHOR "AS IS" AND ANY EXPRESS OR IMPLIED WARRANTIES, INCLUDING, BUT NOT LIMITED TO, THE IMPLIED WARRANTIES OF MERCHANTABILITY AND FITNESS FOR A PARTICULAR PURPOSE ARE DISCLAIMED. IN NO EVENT SHALL THE AUTHOR BE LIABLE FOR ANY DIRECT, INDIRECT, INCIDENTAL, SPECIAL, EXEMPLARY, OR CONSEQUENTIAL DAMAGES (INCLUDING, BUT NOT LIMITED TO, PROCUREMENT OF SUBSTITUTE GOODS OR SERVICES; LOSS OF USE, DATA, OR PROFITS; OR BUSINESS INTERRUPTION) HOWEVER CAUSED AND ON ANY THEORY OF LIABILITY, WHETHER IN CONTRACT, STRICT LIABILITY, OR TORT (INCLUDING NEGLIGENCE OR OTHERWISE) ARISING IN ANY WAY OUT OF THE USE OF THIS SOFTWARE, EVEN IF ADVISED OF THE POSSIBILITY OF SUCH DAMAGE.

(31) - M. Warner Losh (targets using libc/posix)

Copyright (c) 1998, M. Warner Losh <imp@freebsd.org>

All rights reserved.

Redistribution and use in source and binary forms, with or without modification, are permitted provided that the following conditions are met:

1. Redistributions of source code must retain the above copyright notice, this list of conditions and the following disclaimer.
2. Redistributions in binary form must reproduce the above copyright notice, this list of conditions and the following disclaimer in the documentation and/or other materials provided with the distribution.

THIS SOFTWARE IS PROVIDED BY THE AUTHOR AND CONTRIBUTORS "AS IS" AND ANY EXPRESS OR IMPLIED WARRANTIES, INCLUDING, BUT NOT LIMITED TO, THE IMPLIED WARRANTIES OF MERCHANTABILITY AND FITNESS FOR A PARTICULAR PURPOSE ARE DISCLAIMED. IN NO EVENT SHALL THE AUTHOR OR CONTRIBUTORS BE LIABLE FOR ANY DIRECT, INDIRECT, INCIDENTAL, SPECIAL, EXEMPLARY, OR CONSEQUENTIAL DAMAGES (INCLUDING, BUT NOT LIMITED TO, PROCUREMENT OF SUBSTITUTE GOODS OR SERVICES; LOSS OF USE, DATA, OR PROFITS; OR BUSINESS INTERRUPTION) HOWEVER CAUSED AND ON ANY THEORY OF LIABILITY, WHETHER IN CONTRACT, STRICT LIABILITY, OR TORT (INCLUDING NEGLIGENCE OR OTHERWISE) ARISING IN ANY WAY OUT OF THE USE OF THIS SOFTWARE, EVEN IF ADVISED OF THE POSSIBILITY OF SUCH DAMAGE.

(32) - Andrey A. Chernov (targets using libc/posix)

Copyright (C) 1996 by Andrey A. Chernov, Moscow , Russia .

All rights reserved.

Redistribution and use in source and binary forms, with or without modification, are permitted provided that the following conditions are met:

1. Redistributions of source code must retain the above copyright notice, this list of conditions and the following disclaimer.
2. Redistributions in binary form must reproduce the above copyright notice, this list of conditions and the following disclaimer in the documentation and/or other materials provided with the distribution.

THIS SOFTWARE IS PROVIDED BY THE AUTHOR "AS IS" AND ANY EXPRESS OR IMPLIED WARRANTIES, INCLUDING, BUT NOT LIMITED TO, THE IMPLIED WARRANTIES OF MERCHANTABILITY AND FITNESS FOR A PARTICULAR PURPOSE ARE DISCLAIMED. IN NO EVENT SHALL THE REGENTS OR CONTRIBUTORS BE LIABLE FOR ANY DIRECT, INDIRECT, INCIDENTAL, SPECIAL, EXEMPLARY, OR CONSEQUENTIAL DAMAGES (INCLUDING, BUT NOT LIMITED TO, PROCUREMENT OF SUBSTITUTE GOODS OR SERVICES; LOSS OF USE, DATA, OR PROFITS; OR BUSINESS INTERRUPTION) HOWEVER CAUSED AND ON ANY THEORY OF LIABILITY, WHETHER IN CONTRACT, STRICT LIABILITY, OR TORT (INCLUDING NEGLIGENCE OR OTHERWISE) ARISING IN ANY WAY OUT OF THE USE OF THIS SOFTWARE, EVEN IF ADVISED OF THE POSSIBILITY OF SUCH DAMAGE.

(33) - Daniel Eischen (targets using libc/posix)

Copyright (c) 2001 Daniel Eischen <deischen@FreeBSD.org>.

All rights reserved.

Redistribution and use in source and binary forms, with or without modification, are permitted provided that the following conditions are met:

1. Redistributions of source code must retain the above copyright notice, this list of conditions and the following disclaimer.
2. Redistributions in binary form must reproduce the above copyright notice, this list of conditions and the following disclaimer in the documentation and/or other materials provided with the distribution.

THIS SOFTWARE IS PROVIDED BY THE AUTHOR AND CONTRIBUTORS "AS IS" AND ANY EXPRESS OR IMPLIED WARRANTIES, INCLUDING, BUT NOT LIMITED TO, THE IMPLIED WARRANTIES OF MERCHANTABILITY AND FITNESS FOR A PARTICULAR PURPOSE ARE DISCLAIMED. IN NO EVENT SHALL THE REGENTS OR CONTRIBUTORS BE LIABLE FOR ANY DIRECT, INDIRECT, INCIDENTAL, SPECIAL, EXEMPLARY, OR CONSEQUENTIAL DAMAGES (INCLUDING, BUT NOT LIMITED TO, PROCUREMENT OF SUBSTITUTE GOODS OR SERVICES; LOSS OF USE, DATA, OR PROFITS; OR BUSINESS INTERRUPTION) HOWEVER CAUSED AND ON

ANY THEORY OF LIABILITY, WHETHER IN CONTRACT, STRICT LIABILITY, OR TORT (INCLUDING NEGLIGENCE OR OTHERWISE) ARISING IN ANY WAY OUT OF THE USE OF THIS SOFTWARE, EVEN IF ADVISED OF THE POSSIBILITY OF SUCH DAMAGE.

(35) - ARM Ltd (arm and thumb variant targets only)

Copyright (c) 2009 ARM Ltd

All rights reserved.

Redistribution and use in source and binary forms, with or without modification, are permitted provided that the following conditions are met:

1. Redistributions of source code must retain the above copyright notice, this list of conditions and the following disclaimer.
2. Redistributions in binary form must reproduce the above copyright notice, this list of conditions and the following disclaimer in the documentation and/or other materials provided with the distribution.
3. The name of the company may not be used to endorse or promote products derived from this software without specific prior written permission.

THIS SOFTWARE IS PROVIDED BY ARM LTD "AS IS" AND ANY EXPRESS OR IMPLIED WARRANTIES, INCLUDING, BUT NOT LIMITED TO, THE IMPLIED WARRANTIES OF MERCHANTABILITY AND FITNESS FOR A PARTICULAR PURPOSE ARE DISCLAIMED. IN NO EVENT SHALL ARM LTD BE LIABLE FOR ANY DIRECT, INDIRECT, INCIDENTAL, SPECIAL, EXEMPLARY, OR CONSEQUENTIAL DAMAGES (INCLUDING, BUT NOT LIMITED TO, PROCUREMENT OF SUBSTITUTE GOODS OR SERVICES; LOSS OF USE, DATA, OR PROFITS; OR BUSINESS INTERRUPTION) HOWEVER CAUSED AND ON ANY THEORY OF LIABILITY, WHETHER IN CONTRACT, STRICT LIABILITY, OR TORT (INCLUDING NEGLIGENCE OR OTHERWISE) ARISING IN ANY WAY OUT OF THE USE OF THIS SOFTWARE, EVEN IF ADVISED OF THE POSSIBILITY OF SUCH DAMAGE.

(36) - CodeSourcery, Inc.

Copyright (c) 2009 CodeSourcery, Inc.

All rights reserved.

Redistribution and use in source and binary forms, with or without modification, are permitted provided that the following conditions are met:

- * Redistributions of source code must retain the above copyright notice, this list of conditions and the following disclaimer.
- * Redistributions in binary form must reproduce the above copyright notice, this list of conditions and the following disclaimer in the documentation and/or other materials provided with the distribution.

* Neither the name of CodeSourcery nor the names of its contributors may be used to endorse or promote products derived from this software without specific prior written permission.

THIS SOFTWARE IS PROVIDED BY CODESOURCERY, INC. "AS IS" AND ANY EXPRESS OR IMPLIED WARRANTIES, INCLUDING, BUT NOT LIMITED TO, THE IMPLIED WARRANTIES OF MERCHANTABILITY AND FITNESS FOR A PARTICULAR PURPOSE ARE DISCLAIMED. IN NO EVENT SHALL CODESOURCERY BE LIABLE FOR ANY DIRECT, INDIRECT, INCIDENTAL, SPECIAL, EXEMPLARY, OR CONSEQUENTIAL DAMAGES (INCLUDING, BUT NOT LIMITED TO, PROCUREMENT OF SUBSTITUTE GOODS OR SERVICES; LOSS OF USE, DATA, OR PROFITS; OR BUSINESS INTERRUPTION) HOWEVER CAUSED AND ON ANY THEORY OF LIABILITY, WHETHER IN CONTRACT, STRICT LIABILITY, OR TORT (INCLUDING NEGLIGENCE OR OTHERWISE) ARISING IN ANY WAY OUT OF THE USE OF THIS SOFTWARE, EVEN IF ADVISED OF THE POSSIBILITY OF SUCH DAMAGE.

(37) MIPS Technologies, Inc

/*

* Copyright (c) 2009 MIPS Technologies, Inc.

*

* All rights reserved.

*

* Redistribution and use in source and binary forms, with or without
* modification, are permitted provided that the following conditions
* are met:

*

* * Redistributions of source code must retain the above copyright
* notice, this list of conditions and the following disclaimer.

* * Redistributions in binary form must reproduce the above
* copyright

* notice, this list of conditions and the following disclaimer
* in the documentation and/or other materials provided with
* the distribution.

* * Neither the name of MIPS Technologies Inc. nor the names of its
* contributors may be used to endorse or promote products derived

* from this software without specific prior written permission.

*

* THIS SOFTWARE IS PROVIDED BY THE COPYRIGHT HOLDERS AND CONTRIBUTORS
* "AS IS" AND ANY EXPRESS OR IMPLIED WARRANTIES, INCLUDING, BUT NOT
* LIMITED TO, THE IMPLIED WARRANTIES OF MERCHANTABILITY AND FITNESS FOR
* A PARTICULAR PURPOSE ARE DISCLAIMED. IN NO EVENT SHALL THE COPYRIGHT
* OWNER OR CONTRIBUTORS BE LIABLE FOR ANY DIRECT, INDIRECT, INCIDENTAL,
* SPECIAL, EXEMPLARY, OR CONSEQUENTIAL DAMAGES (INCLUDING, BUT NOT
* LIMITED TO, PROCUREMENT OF SUBSTITUTE GOODS OR SERVICES; LOSS OF USE,
* DATA, OR PROFITS; OR BUSINESS INTERRUPTION) HOWEVER CAUSED AND ON ANY
* THEORY OF LIABILITY, WHETHER IN CONTRACT, STRICT LIABILITY, OR TORT
* (INCLUDING NEGLIGENCE OR OTHERWISE) ARISING IN ANY WAY OUT OF THE USE
* OF THIS SOFTWARE, EVEN IF ADVISED OF THE POSSIBILITY OF SUCH DAMAGE.

*/

Parent topic: [Notices](#)

Copyright Notice

All rights reserved. No part of this publication may be reproduced, stored in a retrieval system, or transmitted in any form or by any means, electronic, mechanical, photocopying, recording, or otherwise, without the prior written permission of Seiko Epson Corporation. The information contained herein is designed only for use with this EPSON product. Epson is not responsible for any use of this information as applied to other products.

Neither Seiko Epson Corporation nor its affiliates shall be liable to the purchaser of this product or third parties for damages, losses, costs, or expenses incurred by purchaser or third parties as a result of: accident, misuse, or abuse of this product or unauthorized modifications, repairs, or alterations to this product, or (excluding the U.S.) failure to strictly comply with Seiko Epson Corporation's operating and maintenance instructions.

Seiko Epson Corporation shall not be liable for any damages or problems arising from the use of any options or any consumable products other than those designated as Original EPSON Products or EPSON Approved Products by Seiko Epson Corporation.

This information is subject to change without notice.

[A Note Concerning Responsible Use of Copyrighted Materials](#)

[Copyright Attribution](#)

Parent topic: [Notices](#)

A Note Concerning Responsible Use of Copyrighted Materials

Epson encourages each user to be responsible and respectful of the copyright laws when using any EPSON product. While some countries' laws permit limited copying or reuse of copyrighted material in certain circumstances, those circumstances may not be as broad as some people assume. Contact your legal advisor for any questions regarding copyright law.

Parent topic: [Copyright Notice](#)

Copyright Attribution

This information is subject to change without notice.

© 2012 Epson America, Inc.

2/12

CPD-35679

Parent topic: [Copyright Notice](#)

Free Manuals Download Website

<http://myh66.com>

<http://usermanuals.us>

<http://www.somanuals.com>

<http://www.4manuals.cc>

<http://www.manual-lib.com>

<http://www.404manual.com>

<http://www.luxmanual.com>

<http://aubethermostatmanual.com>

Golf course search by state

<http://golfingnear.com>

Email search by domain

<http://emailbydomain.com>

Auto manuals search

<http://auto.somanuals.com>

TV manuals search

<http://tv.somanuals.com>