



User's Guide

Multimedia Projector

EB-536Wi EB-530

EB-535W EB-520



EB-525W

Notations Used in This Guide





- **Safety indications**

The documentation and the projector use graphical symbols to show how to use the projector safely.

The indications and their meaning are as follows. Make sure you understand them properly before reading the

 Warning	This symbol indicates information that, if ignored, could possibly result in personal injury.
 Caution	This symbol indicates information that, if ignored, could possibly result in personal injury.

- **General information indications**

Attention	Indicates procedures which may result in damage or injury if sufficient care is not taken.
	Indicates additional information and points which may be useful to know regarding a topic.
	Indicates a page where detailed information regarding a topic can be found.
	Indicates that an explanation of the underlined word or words in front of this symbol appears in the section of the "Appendix".  "Glossary" p.186
[Name]	Indicates the name of the buttons on the remote control or the control panel. Example: [Esc] button
Menu Name	Indicates Configuration menu items. Example: Select Brightness from Image . Image - Brightness

Contents

Notations Used in This Guide 2

Introduction

Projector Features 8

Quick and Easy Set up, Projection, and Storage	8
Connecting with a USB Cable and Projecting (USB Display)	8
Useful Functions for Projecting Images	8
Connect a USB Storage Device and Project Movies or Images (PC Free)	8
Flip the Image Horizontally and Project (Flip Horizontal)	8
Various Functions for Excellent Power Saving	8
Making the Most of the Remote Control	8
Enlarge and Project Your Files with the Document Camera	9
Enhanced Security Functions	9
Taking Full Advantage of a Network Connection	9
Interactive Features (Easy Interactive Function) (EB-536Wi only)	10

Part Names and Functions 11

Front/Top	11
Rear	12
Base	14
Control Panel	15
Remote Control	16
Replacing the Remote Control Batteries	18
Remote Control Operating Range	19
Easy Interactive Pen (EB-536Wi only)	19
Replacing the Battery for the Interactive Pen	20
Replacing the Tip of the Interactive Pen	21

Preparing the Projector

Installing the Projector 23

Installation Methods	23
Installation Methods	24
When Using the Interactive Features (EB-536Wi only)	24

Connecting Equipment 25

Connecting a Computer	25
Connecting Image Sources	25
Connecting USB Devices	25
Connecting a Microphone	25
Connecting External Equipment	25
Connecting a LAN Cable	25
Installing the Optional Wireless LAN U	25
Installing the Optional Quick Wirele	25
Connecting Multiple Projectors (EB-53	25

Basic Usage

Projecting Images 26

Turning On the Projector	26
Turning Off the Projector	26
Automatically Detect Input Signals and	26
Switching to the Target Image Using t	26
Projecting with USB Display	26
System requirements	26
Connecting for the First Time	26
Uninstalling	26

Adjusting Projected Images 27

Correcting Keystone Distortion	27
Correcting Manually	27
Correcting Automatically (EB-536W	27
Adjusting the Image Size	27
Adjusting the Image Position	27
Adjusting the Horizontal Tilt	27
Correcting the Focus	27
Adjusting the Volume	27
Selecting the Projection Quality (Select	27
Setting Auto Iris	27
Changing the Aspect Ratio of the Proj	27
Changing Methods	27

Contents

Changing the Aspect Mode (EB-536Wi/EB-535W/EB-525W only)	55
Changing the Aspect Mode (EB-530/EB-520 only)	56

Using the Interactive Features (EB-536Wi only)

Interactive Feature Modes	59
Drawing on a Projected Image (Annotation Mode)	60
Using the Projected Screen as a Whiteboard (Whiteboard Mode)	61
Controlling a Computer from the Projected Screen (Computer Interactive Mode)	62
Computer Interactive Mode System Requirements	62
Using Computer Interactive Mode	62
Easy Interactive Driver System Requirements (OS X only)	65
Installing Easy Interactive Driver on OS X	65
Using the Interactive Pens	67
Pen Calibration	68
Calibrating Automatically	68
Calibrating Manually	69
Adjusting the Pen Operation Area	71
Interacting with the Screen	74
Switching the Interactive Mode	74
Annotation Mode and Whiteboard Mode Toolbars	75
Selecting Line Width and Color	76
Selecting Whiteboard Templates	77
Projector Control Toolbar	77
Selecting Network Device Display from the Projector Control Toolbar	78
Using the Interactive Features over a Network	80
Precautions When Connecting to a Projector on a Different Subnet	80
Windows Pen Input and Ink Tools	82
Enabling Windows Pen Input and Ink Features	82
Using Windows Pen Input and Ink Features	83

Useful Functions

Projection Functions	
Projecting Images Stored on a USB Storage Device	
Specifications for Files that Can Be Projected	
PC Free Examples	
PC Free Operating Methods	
Projecting the Selected Images or Movies	
Projecting Image Files in a Folder in a Network	
Image File Display Settings and Slicing	
Flipping the Image Horizontally (Flip Horizontal)	
Hiding the Image and Sound Temporarily	
Freezing the Image (Freeze)	
Pointer Function (Pointer)	
Enlarging Part of the Image (E-Zoom)	
Using the Remote Control to Operate	
Saving a User's Logo	
Saving User Pattern	
Security Functions	
Managing Users (Password Protection)	
Kinds of Password Protection	
Setting Password Protection	
Entering the Password	
Restricting Operation (Control Panel Lock)	
Anti-Theft Lock	
Installing the Wire Lock	
Monitoring and Controlling	
About EasyMP Monitor	
Message Broadcasting	
Changing Settings Using a Web Browser	
Projector Setup	
Displaying the Web Control Screen	
Displaying the Web Remote screen	
Using the Mail Notification Function to	
Reading Error Notification Mail	
Management Using SNMP	

Contents

ESC/VP21 Commands	106
Command list	106
Cable Layouts	106
About PLink	107
About Crestron RoomView®	108
Operating a Projector from Your Computer	108

Configuration Menu

Using the Configuration Menu	113
---	------------

List of Functions	114
------------------------------------	------------

Configuration Menu Table	114
Network menu	115
Image Menu	116
Signal Menu	117
Settings Menu	119
Extended Menu	120
Easy Interactive Function Setting Items (EB-536Wi only)	123
Network Menu	124
Notes on Operating the Network Menu	125
Soft Keyboard Operations	125
Basic Menu	126
Wireless LAN Menu	127
Search Access Point screen	129
Security Menu	129
Wired LAN Menu	130
Mail Menu	131
Others Menu	132
Reset Menu	133
ECO Menu	133
Info Menu (Display Only)	134
Reset Menu	135

Performing Batch Setup for Multiple Projectors	136
---	------------

Setting Up Using a USB Memory	136
Saving Settings to a USB Memory	136

Reflecting Saved Settings to Other Setup by Connecting the Computer and Saving Settings to a Computer	
Reflecting Saved Settings to Other When Setup Fails	

Troubleshooting

Using the Help	
---------------------------------	--

Problem Solving	
----------------------------------	--

Reading the Indicators	
When the Indicators Provide No Help	
Problems Relating to Images	
No Images Appear	
Moving Images are Not Displayed (.	
Projection Stops Automatically	
The Message Not supported is Displayed	
The Message No Signal is Displayed	
Images are Fuzzy, Out of Focus, or I	
Interference or Distortion Appear in	
The Mouse Cursor Flickers (Only wh	
The Image Is Truncated (Large) or S	
Image Colors are Not Right	
Images Appear Dark	
Problems when Projection Starts	
The Projector Does Not Turn On	
Other Problems	
No Sound can be Heard or the Sour	
No Sound can be Heard from the M	
There is Noise in the Audio (Only w	
The Remote Control Does Not Work	
I Want to Change the Language for	
Mail is Not Received even if a Probl	
Cannot Change Settings Using a W	
Problems with the Interactive Feature	
Cannot Draw on the Projected Scre	

Contents

Cannot Operate a Computer from the Projected Screen After Connecting to the Computer	158
The Message An error occurred in the Easy Interactive Function. is Displayed . . .	158
Computer's Mouse Does Not Work Correctly	158
The Interactive Pen Does Not Work	159
The Response Time for the Interactive Pen is Slow (Only when Projecting USB Display)	159
The Dot Moves Automatically or Does Not Move to the Next Position During Manual Calibration	160

About Event ID	161
---------------------------------	------------

Maintenance

Cleaning	163
---------------------------	------------

Cleaning the Projector's Surface	163
Cleaning the Lens	163
Cleaning the Air Filter	163

Replacing Consumables	166
--	------------

Replacing the Lamp	166
Lamp Replacement Period	166
How to Replace the Lamp	166
Resetting the Lamp Hours	169
Replacing the Air Filter	169
Air Filter Replacement Period	169
How to Replace the Air Filter	169

Appendix

Optional Accessories and Consumables	172
---	------------

Optional Accessories	172
Consumables	172

Screen Size and Projection Distance	173
--	------------

Projection Distance (for EB-536Wi/EB-535W/EB-525W)	173
Projection Distance (For EB-530/EB-520)	174

Supported Monitor Displays

Supported Resolutions	
Computer Signals (analog RGB)	
Component Video	
Composite Video	
Input Signal from the HDMI Port	

Specifications

Projector General Specifications	
--	--

Appearance

Glossary

General Notes

Wireless Telegraphy Act Regulations	
About Notations	
General Notice:	

Index

Introduction

This chapter explains the projector's features and the part names.

Projector Features

Quick and Easy Set up, Projection, and Storage

- Turn the projector on and off by simply plugging in or unplugging.
- Projection only starts when a computer image is input (Auto Power On).
- Project onto large screens from a short distance.
- Make easy height adjustments with one lever.
- No cool down delay makes it easy to put away.

Connecting with a USB Cable and Projecting (USB Display)

By simply connecting a USB cable, you can project images from a computer's screen without a Computer cable.

☛ "Projecting with USB Display" [p.45](#)

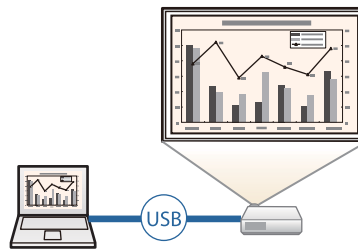

Useful Functions for Projecting Images

Connect a USB Storage Device and Project Movies or Images (PC Free)

You can connect USB storage devices or digital cameras to the projector and project saved images.

A wide range of file formats are supported such as movies or images.

☛ "Projecting Images Stored on a USB Storage Device (PC Free)" [p.85](#)

Flip the Image Horizontally and Vertically

You can temporarily flip the image horizontally and vertically when projecting images for dance or sports.

☛ "Flipping the Image Horizontally and Vertically" [p.132](#)

Various Functions for Excellent Projection

- Various functions to prevent white burn-in.
The projector comes with a number of functions such as dimming the projected image, adjusting power consumption, and ECO Display.

☛ "ECO Menu" [p.133](#)

- Function for displaying the power consumption (ECO Display) () that indicate the power consumption on the left of the projected screen when projecting images.
ECO Display is set to OFF by default.

☛ ECO - ECO Display [p.133](#)

Making the Most of the Remote Control

You can use the remote control to zoom in and out of a part of the image. You can also use the remote control as a mouse for presentations or as a mouse for the projector.

☛ "Pointer Function (Pointer)" [p.93](#)

☛ "Enlarging Part of the Image" [p.93](#)

☛ "Using the Remote Control as a Mouse)" [p.93](#)

Projector Features

Enlarge and Project Your Files with the Document Camera

You can project paper documents and objects using the optional Document Camera.

By connecting to a computer and using the software supplied, you can make full use of the projector's capabilities.

☛ "Optional Accessories" [p.172](#)

Enhanced Security Functions

- **Password Protect to restrict and manage users**

By setting a Password you can restrict who can use the projector.

☛ "Managing Users (Password Protection)" [p.98](#)

- **Control Panel Lock to restrict button operation on the control panel**

You can use this to prevent people changing projector settings without permission at events, in schools, and so on.

☛ "Restricting Operation (Control Panel Lock)" [p.100](#)

- **Equipped with various anti-theft devices**

The projector is equipped with the following types of anti-theft security devices.

- Security slot
- Security cable installation point

☛ "Anti-Theft Lock" [p.101](#)

- Sharing the projector over a network
By using EasyMP Network Projection you can connect the projector to a network and share it with multiple computers. You can project images and data from each computer without having to reconnect cables. You can also project to multiple projectors from one computer.

☛ [EasyMP Network Projection Operation Guide](#)

- Projecting images from multiple computers
By using EasyMP Multi PC Projection you can project four screens from multiple computers connected to the network, or from smartphones or tablets with Epson iProjection installed, can be projected simultaneously.

By making yourself the host of a meeting you can control the projected screens from connected computers allowing you to advance the meeting smoothly.

You can also project the same screen to multiple remote projectors on the network.

☛ [EasyMP Multi PC Projection Operation Guide](#)

Taking Full Advantage of a Network Connection

You can perform the following operations by using EasyMP Network Projection and EasyMP Multi PC Projection that can be found on the EPSON Projector Software CD-ROM.

Projector Features

You can perform the following operations by using optional devices and applications.

- Wirelessly projecting your computer's screen

By installing the optional Wireless LAN unit, you can project a computer screen over a network.

☛ "Installing the Optional Wireless LAN Unit" p.36



- Connecting to a computer with Quick Wireless easily

By simply connecting the optional Quick Wireless Connection USB Key to a computer, you can automatically perform network settings for a wireless LAN connection, and project the computer's screen (Windows only).

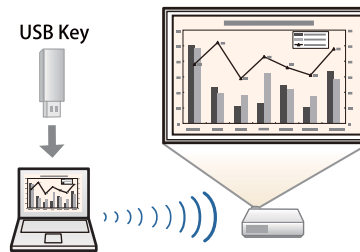

- Projecting images from portable devices over a network

If Epson iProjection is installed on your smart phone or tablet device, you can wirelessly project data from the device. You can download Epson iProjection for free from the App Store or from Google play. Any fees incurred when communicating with the App Store or Google play are the responsibility of the customer.



Interactive Features (Epson EB-536Wi only)

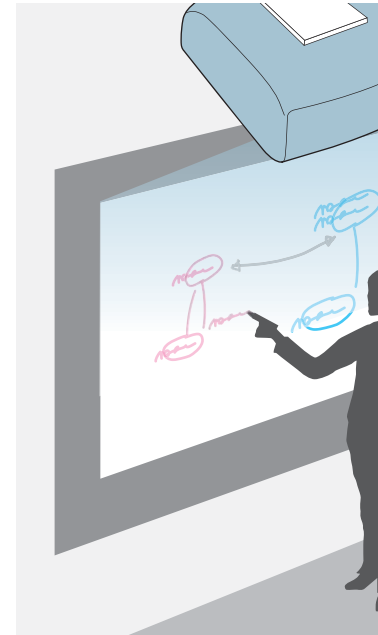

You can perform the following

- Use the projected screen as a
- Draw on content projected from
- Operate a computer from the
- Operate the projector from the
- Select devices on the projected network using the supplied Ea
- Use the interactive features over Network Projection or the opt
- ☛ "Using the Interactive Features"

Part Names and Functions

The illustrations currently used in this guide are for the EB-536Wi.

Front/Top

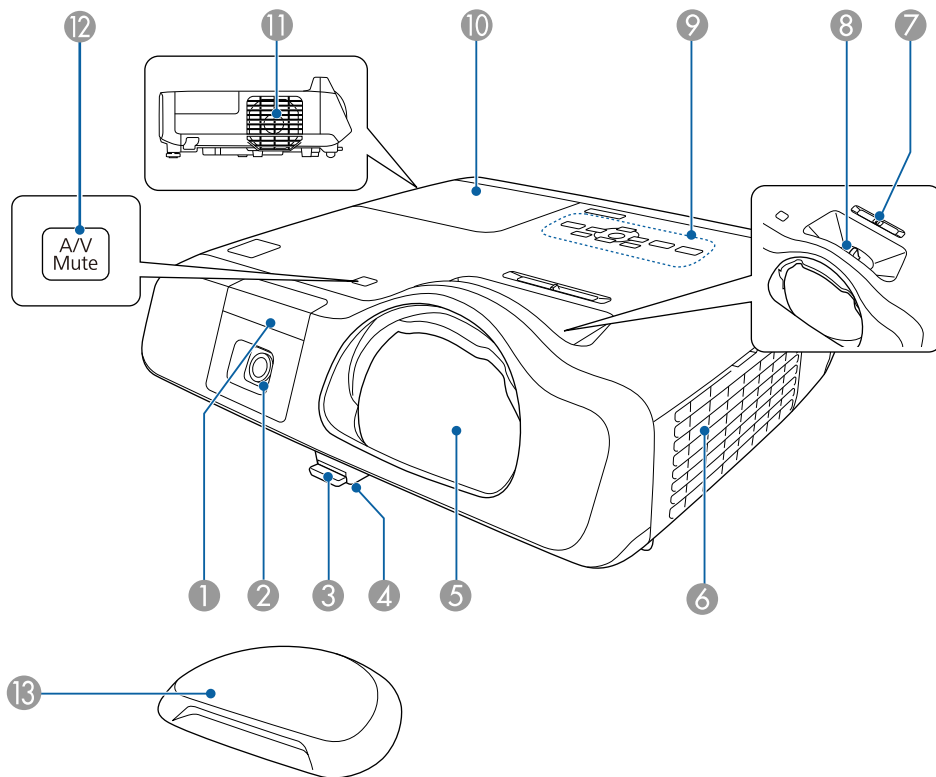

Name		
③	Foot adjust lever	Press the adjustable ☛ "Adju
④	Front adjustable foot	When set adjust the ☛ "Adju
⑤	Projection lens	Projects i
⑥	Air intake vent (Air filter)	Takes in a ☛ "Clear ☛ "Repl
⑦	Horizontal keystone adjuster (EB-536Wi only)	Corrects ☛ "Corr
⑧	Focus ring	Adjusts th ☛ "Corr
⑨	Control Panel	Operates ☛ "Cont
⑩	Lamp cover	Open wh ☛ "Repl





Name		Function
①	Remote receiver	Receives signals from the remote control.
②	Easy Interactive Function receiver (EB-536Wi only)	Receives signals from the interactive pen. ☛ "Using the Interactive Features (EB-536Wi only)" p.58

Part Names and Functions

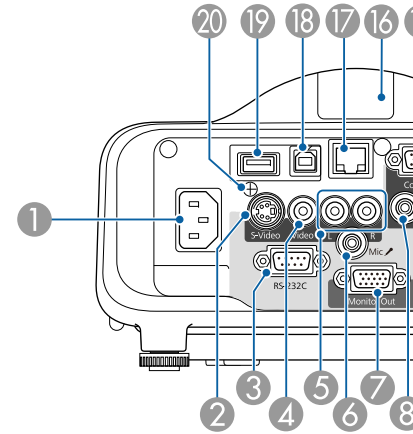
	Name	Function
11	Air exhaust vent	Exhaust vent for air used to cool the projector internally. <div data-bbox="497 325 1069 587" style="border: 1px solid black; padding: 5px; margin: 5px 0;"> <p>Warning</p> <p>Do not look into the vents. If the lamp explodes, gases may escape and small fragments of glass may be scattered which could cause an injury. Contact a doctor if any fragments of broken glass are inhaled or get into the eyes or mouth.</p> </div> <div data-bbox="497 628 1069 855" style="border: 1px solid black; padding: 5px; margin: 5px 0;"> <p>Caution</p> <p>While projecting, do not put your face or hands near the air exhaust vent, and do not place objects that may become warped or damaged by heat near the vent.</p> </div>
12	[A/V Mute] button	<ul style="list-style-type: none"> • Turns the video and audio on or off.  "Hiding the Image and Sound Temporarily (A/V Mute)" p.90 • Hold down the button for approximately three seconds to perform auto pen calibration (EB-536Wi only).
13	Lens cover	Install when not using the projector to protect the lens from being damaged or soiled.

Rear



	Name	
1	Power inlet	Connects to the power cord.  "Turn On/Off"
2	S-Video port	For S-video input.
3	RS-232C port	When connected to a computer, it allows you to control the projector.  "ESC"
4	Video port	Inputs composite video.
5	Audio-L/R port	Inputs audio from a computer or the projector.
6	Mic port	Inputs audio from a microphone.  "Connect/Disconnect"
7	Monitor Out port	Outputs video from the projector to an external monitor.  "Connect/Disconnect"
8	Audio1 port	Inputs audio from a computer.

Part Names and Functions

	Name	Function
9	Audio Out port	Outputs audio from the currently projected image to an external speaker.
10	Audio2 port	Inputs audio from equipment connected to the Computer2 port.
11	SYNC IN/OUT port (EB-536Wi only)	When installing multiple projectors in the same room and using the interactive function, connect projectors using the optional Remote control cable set (ELPKC28). Easy Interactive Pen operations are stabilized when connected. ☛ "Connecting Multiple Projectors (EB-536Wi only)" p.38
12	Speaker	Outputs audio.
13	HDMI port	Inputs video signals from HDMI compatible video equipment and computers. This projector is compatible with HDCP ☛. ☛ "Connecting Image Sources" p.28
14	Computer2 port	Inputs image signals from a computer and component video signals from other video sources.
15	Computer1 port	
16	Remote receiver	Receives signals from the remote control.
17	LAN port	Connects a LAN cable to connect to a network.
18	USB-B port	<ul style="list-style-type: none"> • Connects the projector to a computer using a USB cable, and projects the images on the computer. ☛ "Projecting with USB Display" p.45 • Connects the projector to a computer using a USB cable to use the Wireless Mouse function. ☛ "Using the Remote Control to Operate the Mouse Pointer (Wireless Mouse)" p.93 • When operating the mouse using the Easy Interactive Pen, connect to the computer with the supplied USB cable (EB-536Wi only). ☛ "Controlling a Computer from the Projected Screen (Computer Interactive Mode)" p.62

	Name	
19	USB-A port	<ul style="list-style-type: none"> • Connects the projector to a computer using a USB cable, and projects the images on the computer. ☛ "Projecting with USB Display" p.45 • Connects the projector to a computer using a USB cable to use the Wireless Mouse function. ☛ "Using the Remote Control to Operate the Mouse Pointer (Wireless Mouse)" p.93 • When operating the mouse using the Easy Interactive Pen, connect to the computer with the supplied USB cable (EB-536Wi only). ☛ "Controlling a Computer from the Projected Screen (Computer Interactive Mode)" p.62
20	Wireless LAN unit fixing screw	This screw is used to fix the Wireless LAN unit to the projector.

Part Names and Functions

Base

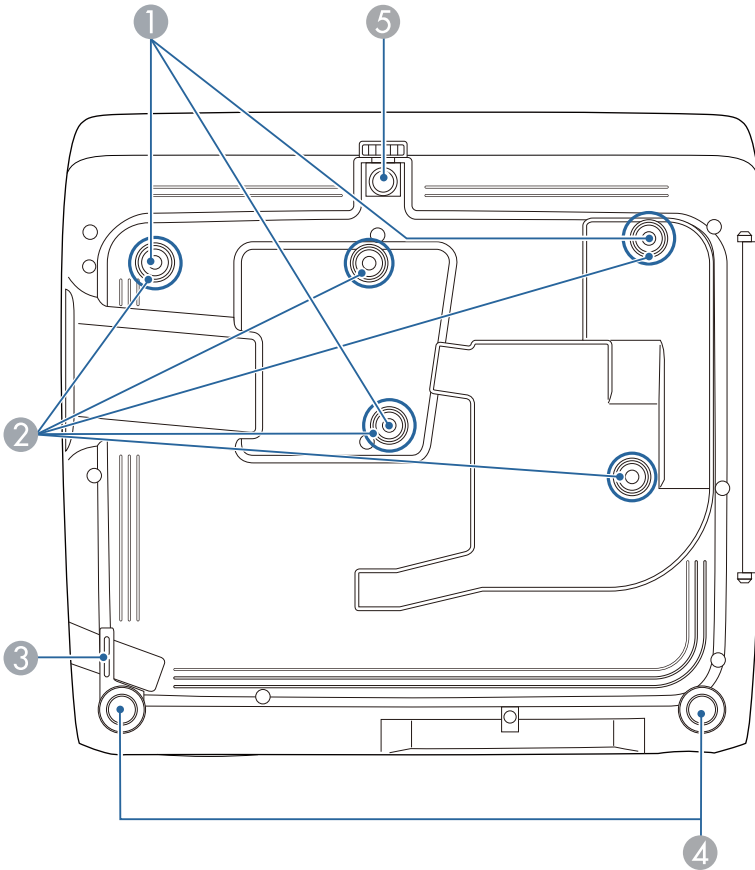

Name		
2	Wall mount plate fixing points (five points)	When attaching the wall mount plate to the projector base, pass a screw through the fixing plate into the wall. ☛ "Optional Accessories" p.172
3	Security cable installation point	Pass a security cable through the lock it in place. ☛ "Installing the Projector" p.23
4	Rear feet	When setting the projector on a surface, retract the feet. ☛ "Adjusting the Projector" p.172
5	Front adjustable foot	When setting the projector on a surface, adjust the height. ☛ "Adjusting the Projector" p.172

Name	Function
1 Ceiling mount fixing points (three points)	Attach the optional Ceiling mount here when suspending the projector from a ceiling. ☛ "Installing the Projector" p.23 ☛ "Optional Accessories" p.172

Part Names and Functions

Control Panel

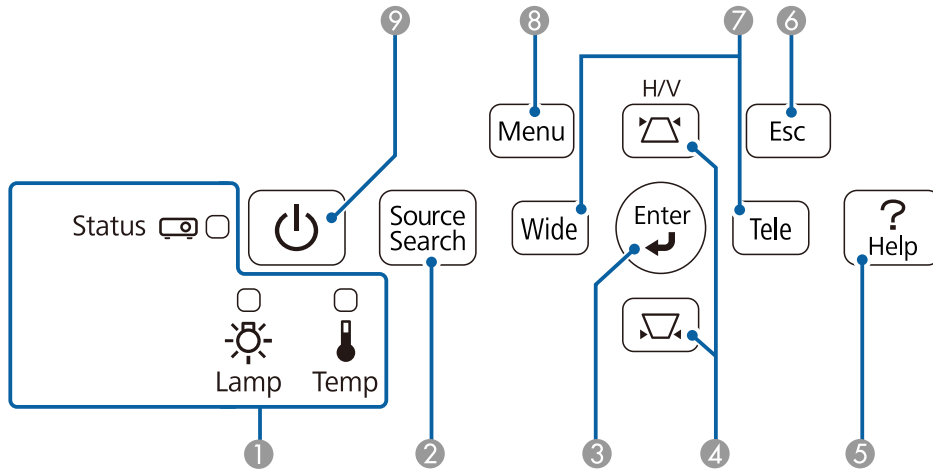

Name	Function
1 Indicators	Indicates the projector's status using color, and by being lit or flashing. ☞ "Reading the Indicators" p.143
2 [Source Search] button	Switches to the image from the input port where video signals are being input. ☞ "Automatically Detect Input Signals and Change the Projected Image (Source Search)" p.43
3 [Enter] button [↵]	<ul style="list-style-type: none"> When the Configuration menu or the Help screen is displayed, it accepts and enters the current selection and moves to the next level. If pressed while projecting analog RGB signals from the Computer1 port or Computer2 port, automatically optimizes the image by adjusting the Tracking, Sync., and Position.

Name	Function
4 [△]/[▽] buttons	<ul style="list-style-type: none"> Perform "H" or "V" adjustment. If pressed while displaying the screen settings menu, it moves the setting to the next level. ☞ "Using the Screen Settings Menu" p.43
5 [Help] button	Displays the Help screen to deal with projector operation. ☞ "Using the Help Screen" p.43
6 [Esc] button	<ul style="list-style-type: none"> Stops the projector. If pressed while displaying the screen settings menu, it moves the setting to the previous level. ☞ "Using the Screen Settings Menu" p.43
7 [Tele]/[Wide] buttons	<ul style="list-style-type: none"> Adjusts the projected image. ☞ "Using the Image Adjustment Buttons" p.43 Corrects the image when the projector is projecting. ☞ "H" or "V" adjustment. If pressed while displaying the screen settings menu, it moves the setting to the previous level. ☞ "Using the Screen Settings Menu" p.43
8 [Menu] button	Displays the screen settings menu. ☞ "Using the Screen Settings Menu" p.43
9 [Power] button [⏻]	Turns the projector on or off. ☞ "Turning the Projector On or Off" p.43

Part Names and Functions

Remote Control

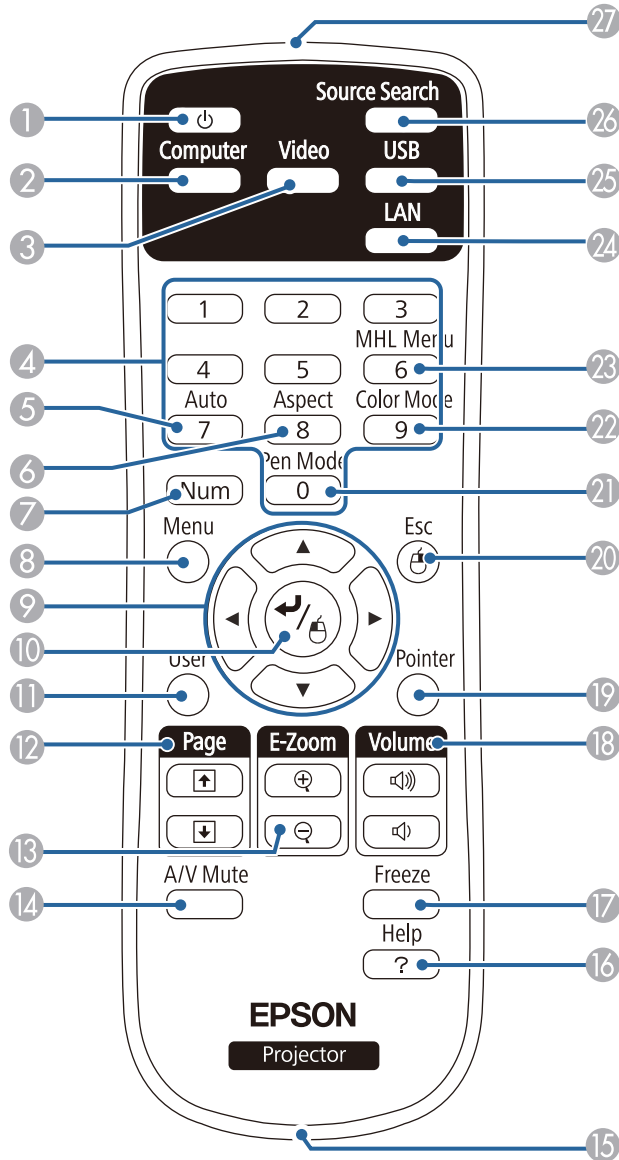

Name		
①	[Power] button [⏻]	Turns the projector on or off. "Turn On" or "Turn Off" indicator.
②	[Computer] button	Each time you press this button, the projector searches for images from the computer.
③	[Video] button	Each time you press this button, the projector searches for images from the S-Video port.
④	Numeric buttons	<ul style="list-style-type: none"> • Enter the number you want to set. • Use the [MHL Menu] button from the [MHL] menu.
⑤	[Auto] button	If pressed, the projector automatically searches for the best image.
⑥	[Aspect] button	Each time you press this button, the projector changes the aspect ratio. See p.55.
⑦	[Num] button	Hold down this button to enter password. See "Settings" p.55.
⑧	[Menu] button	Displays the menu. "Using the Remote Control" p.55.

Part Names and Functions

	Name	Function
9	 <p>buttons</p>	<ul style="list-style-type: none"> When the Configuration menu or the Help screen is displayed, pressing these buttons selects menu items and setting values. <ul style="list-style-type: none"> "Using the Configuration Menu" p.113 When projecting using PC Free, pressing these buttons displays the previous/next image, rotates the image, and so on. <ul style="list-style-type: none"> "Projecting Images Stored on a USB Storage Device (PC Free)" p.85 During Wireless Mouse function, the mouse pointer moves in the direction of the button that was pushed. <ul style="list-style-type: none"> "Using the Remote Control to Operate the Mouse Pointer (Wireless Mouse)" p.93
10	<p>[Enter] button [↵]</p>	<ul style="list-style-type: none"> When the Configuration menu or the Help screen is displayed, it accepts and enters the current selection and moves to the next level. <ul style="list-style-type: none"> "Using the Configuration Menu" p.113 Acts as a mouse's left button when using the Wireless Mouse function. <ul style="list-style-type: none"> "Using the Remote Control to Operate the Mouse Pointer (Wireless Mouse)" p.93
11	<p>[User] button</p>	<p>Select any frequently used item from the available Configuration menu items, and assign it to this button. By pressing the [User] button, the assigned menu item selection/adjustment screen is displayed, allowing you to make one-touch settings/adjustments.</p> <ul style="list-style-type: none"> "Settings Menu" p.119 <p>The following menu items are assigned by default.</p> <ul style="list-style-type: none"> For EB-536Wi: Auto Calibration For EB-535W/EB-525W/EB-530/EB-520: Power Consumption

	Name	
12	<p>[Page] buttons [↶][↷]</p>	<p>Changes the following</p> <ul style="list-style-type: none"> When "U Mouse When "P When <p>When pr buttons c</p>
13	<p>[E-Zoom] button [⊕][⊖]</p>	<p>Enlarges projection</p> <ul style="list-style-type: none"> "Enla
14	<p>[A/V Mute] button</p>	<ul style="list-style-type: none"> Turns "H Mute) You ca pressin Front Rear
15	<p>Strap attachment hole</p>	<p>Allows yo remote c</p>
16	<p>[Help] button</p>	<p>Displays to deal w</p> <ul style="list-style-type: none"> "Usin
17	<p>[Freeze] button</p>	<p>Images a</p> <ul style="list-style-type: none"> "Free
18	<p>[Volume] button [⏪][⏩]</p>	<p>[⏪] Decr [⏩] Incr</p> <ul style="list-style-type: none"> "Adj
19	<p>[Pointer] button</p>	<p>Displays</p> <ul style="list-style-type: none"> "Poir

Part Names and Functions

Name	Function
20 [Esc] button	<ul style="list-style-type: none"> Stops the current function. If pressed when the Configuration menu is displayed, it moves to the previous level. <ul style="list-style-type: none"> "Using the Configuration Menu" p.113 Acts as a mouse's right button when using the Wireless Mouse function. <ul style="list-style-type: none"> "Using the Remote Control to Operate the Mouse Pointer (Wireless Mouse)" p.93
21 [Pen Mode] button	<p>(Only available in EB-536Wi)</p> <p>Changes between operating the computer or drawing using the interactive pen.</p> <ul style="list-style-type: none"> "Using the Interactive Features (EB-536Wi only)" p.58
22 [Color Mode] button	<p>Each time the button is pressed, the color mode changes.</p> <ul style="list-style-type: none"> "Selecting the Projection Quality (Selecting Color Mode)" p.53
23 [MHL Menu] button	Not available on this device.
24 [LAN] button	Switches to the image from the network connected device.
25 [USB] button	<p>Each time the button is pressed, it cycles through the following images:</p> <ul style="list-style-type: none"> USB Display Images from the device connected to the USB-A port
26 [Source Search] button	<p>Switches to the image from the input port where video signals are being input.</p> <ul style="list-style-type: none"> "Automatically Detect Input Signals and Change the Projected Image (Source Search)" p.43
27 Remote control light-emitting area	Outputs remote control signals.

Replacing the Remote Control

If the remote control becomes unusable after being used for some time, the batteries will run out of life. When this happens, replace the old batteries with new AA size manganese or alkaline batteries. For more information, see the manual for the AA size manganese or alkaline batteries.

Attention

Make sure you read the following information.

 [Safety Instructions](#)

- 1 Remove the battery cover. While pushing the battery cover, the cover will pop up.

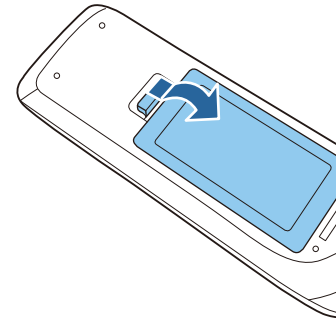

- 2 Replace the old battery with new batteries. Slide the batteries in negative (+) and positive (-) directions.

Part Names and Functions

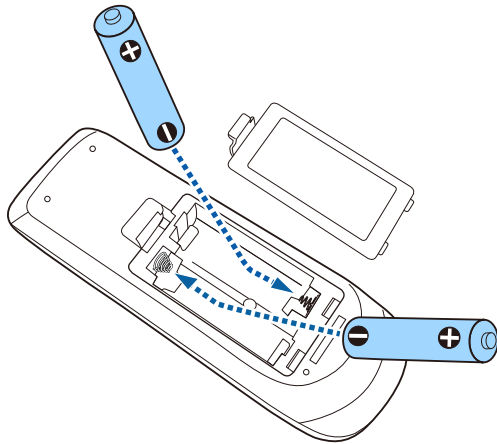

Caution

Check the positions of the (+) and (-) marks inside the battery holder to ensure the batteries are inserted the correct way.

If the batteries are not used correctly, they could explode or leak causing a fire, injury, or damage to the product.

3

Replace the battery cover.

Press the battery cover until it clicks into place.

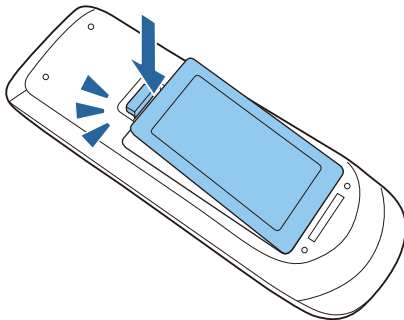

Remote Control Operating Range

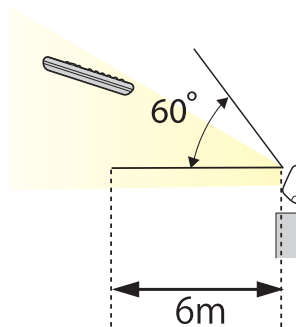
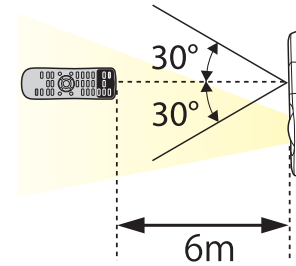

Easy Interactive Pen (EIP)

There are two types of interactive sections. You cannot use interactive sections at the same time.

☛ "Optional Accessories" [p.172](#)

Part Names and Functions

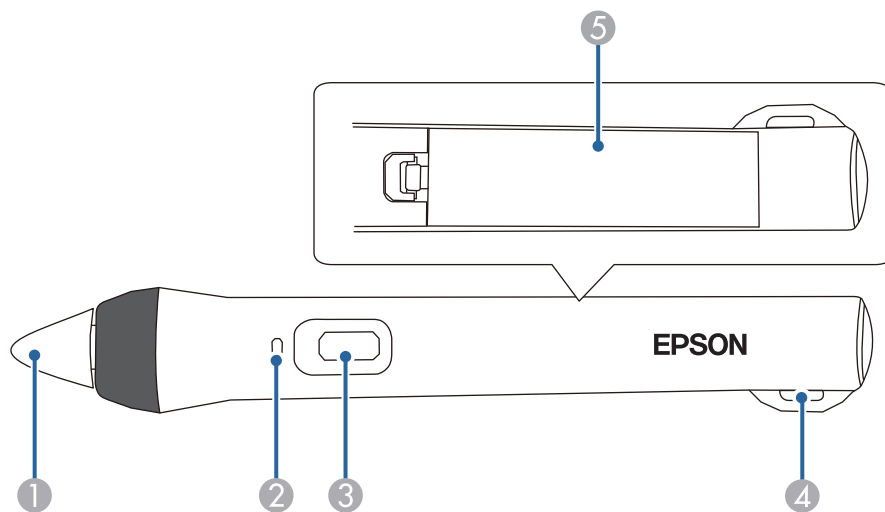

Name	Function
1 Pen Tip	<ul style="list-style-type: none"> Turn on the interactive pen. When turned on, it takes approximately one second before the interactive pen is operational. Hold the pen close to the projected image, and press to use. <ul style="list-style-type: none"> ☛ "Using the Interactive Features (EB-536Wi only)" p.58 ☛ "Optional Accessories" p.172
2 Battery light	<p>Press the button on the side of the pen to indicate the remaining battery power.</p> <ul style="list-style-type: none"> When the battery is charged, the light is lit green until you release the button. When the battery is running low, the light flashes green until you release the button. Does not light when the battery is exhausted. Change the batteries. <ul style="list-style-type: none"> ☛ "Replacing the Battery for the Interactive Pen" p.20
3 Button	<p>Turn on the interactive pen. When turned on, it takes approximately one second before the interactive pen is operational.</p>

Name	
4 Attachment for optional strap or cord	Allows y
5 Battery cover	Open thi ☛ "Rep



The interactive pen turns off after a period of inactivity.

To use the pen again, tap the button on the side of the pen to turn on the power.

Replacing the Battery for the

When you press the button, the battery light flashes. Does not light or flash if the battery light no longer lights or flashes, you need to replace the following types of battery. Other

- AA size manganese battery
 - AA size alkaline manganese battery
 - enloop®*(HR-3UTG/HR-3UTC)
- *enloop® is a registered trademark

Attention

Make sure you read the following

☛ *Safety Instructions*

Part Names and Functions

- 1** Remove the battery cover.
While pushing the battery cover catch, lift the cover up.

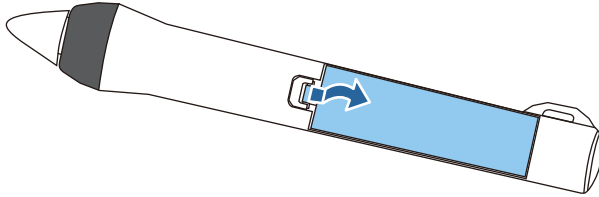

- 2** Replace the old battery with new battery.
Slide the battery in negative side first.

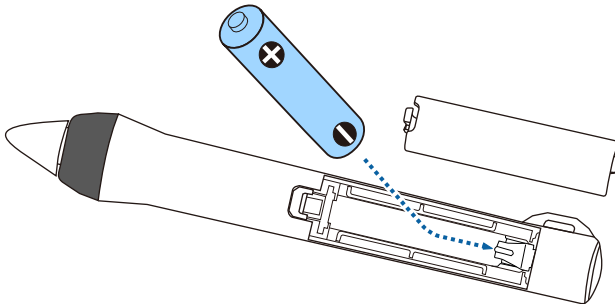

Caution

Check the positions of the (+) and (-) marks inside the battery holder to ensure the battery is inserted the correct way.

If the batteries are not used correctly, they could explode or leak causing a fire, injury, or damage to the product.

- 3** Replace the battery cover.
Press the battery cover up

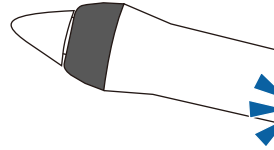

Replacing the Tip of the Inter

Replace the tip of the interactive

☛ "Optional Accessories" [p.172](#)

- 1** Turn the tip of the pen

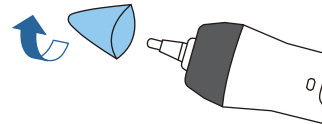

- 2** Turn the new tip to atta

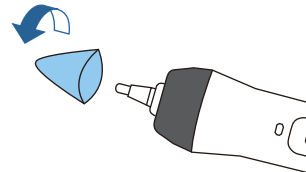

Preparing the Projector

This chapter explains how to install the projector and connect projection sources.

Installing the Projector

Installation Methods

The projector supports the following four different projection methods. Install the projector according to the conditions of the installation location.

Turn the projector off when installing the projector or changing the installation method. Turn the power back on after completing installation.

- Project images from in front of the screen. (Front projection)

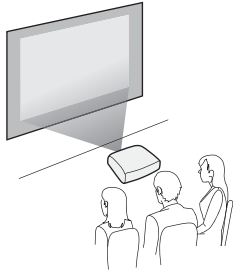

- Project images from behind a translucent screen. (Rear projection)

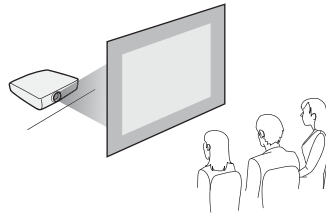

- Suspend the projector from a wall or ceiling and project images from in front of a screen. (Front/Ceiling projection)

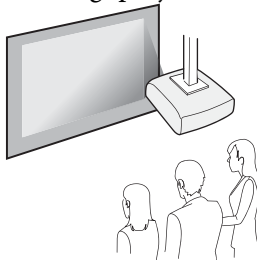

- Suspend the projector from the ceiling and project images from behind a translucent screen. (Rear/Ceiling projection)

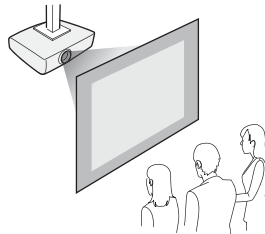

Warning

- A special method of installation is available for projecting from a wall or ceiling. If it is not used correctly, it may cause an accident and injury.
- If you use adhesives on the wall mount fixing points to prevent the screen from falling, things such as lubricants or oils may cause a crack causing it to fall from its mount and cause anyone under the mount and ceiling to be injured. When installing or adjusting the screen, be sure to tighten the screws from loosening and do not use force.
- Do not cover the projector's air vents. If the vents are covered, the internal temperature will rise and the projector may overheat.
- Do not use the projector in a location where it may catch fire due to a lamp.

Attention

Do not use the projector on its side.

Installing the Projector



- We recommend using a smooth, board type screen without any unevenness. If the projection screen is uneven, there may be distortions in the projected image.
- Distortions may occur in the projected image depending on the material of the screen and the installation method.
- When installing the projector on a wall or on the ceiling, make sure you use the correct tools for the installation method.
 - ☛ "Optional Accessories" p.172
- The default Projection setting is **Front**. You can change from **Front** to **Rear** from the Configuration menu.
 - ☛ **Extended - Projection** p.120
- You can change the Projection mode as follows by pressing down the [A/V Mute] button on the remote control for about five seconds.
Front ↔ Front/Ceiling
Rear ↔ Rear/Ceiling

Installation Methods

Install the projector as follows.

- Install the projector so that it is parallel to the screen.
If the projector is installed at an angle to the screen, keystone distortion occurs in the projected image.

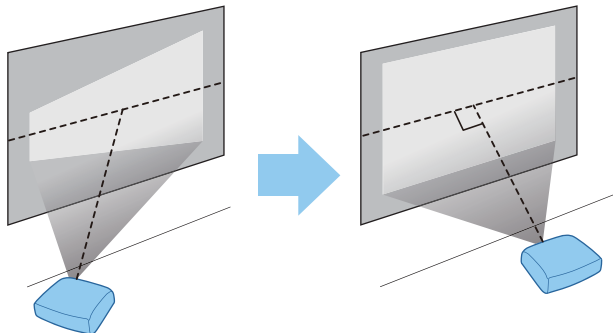

- Place the projector on a level surface.
If the projector is tilted the projected image will be distorted.

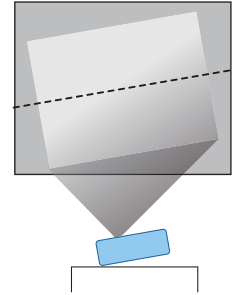

- See the following if you observe keystone distortion on the screen.
 - ☛ "Correcting Keystone Distortion"
- See the following if you observe horizontal distortion on the screen.
 - ☛ "Adjusting the Horizontal Position"
 - ☛ "Correcting Keystone Distortion"

When Using the Interactive Feature

Project from in front of the screen.
Set the Projection mode to **Front** or **Front/Ceiling**.

Install the projector so that the screen is parallel to the projection surface.

Installing the Projector

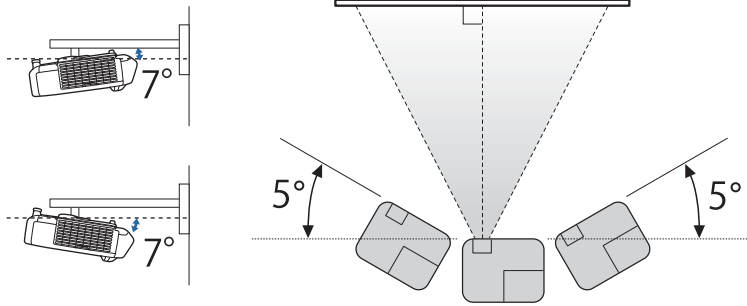

Attention

The interactive features operate by infrared communication. Note the following points when installing the projector.

- Make sure there is no strong light or sunlight shining on the Easy Interactive Function receiver, the projection screen, the projector itself, or the rear of the projector.
- Do not install the projector in direct sunlight through a window. This could cause the interactive features to malfunction.
- If there is any dust stuck to the Easy Interactive Function receiver, it could interfere with infrared communication and you may not be able to use the function normally. Clean the receiver if it is dirty.
- Do not put paint or any stickers on the cover of the Easy Interactive Function receiver.
- Install the projector so that the Easy Interactive Function receiver is not too close to fluorescent lights. If the surrounding area is too bright, the interactive features may not operate correctly.
- When using the interactive features, do not use an infrared remote control or microphone in the same room. The Easy Interactive Pen could malfunction.
- Do not use devices that generate powerful noise, such as rotary devices or transformers, near the projector. You may not be able to operate the interactive features.



- When using the interactive screen is a rectangle with...
- When using the interactive projectors, Easy Interactive... this situation, connect... (ELPKC28) to the projector... **Wired** from the Configuration...
☛ "Connecting Multiple...
☛ **Extended - Easy Interactive Sync of Projectors** p.123

Connecting Equipment

The port name, location, and connector orientation differ depending on the source being connected.

Connecting a Computer

To project images from a computer, connect the computer using one of the following methods.

1 When using the supplied or optional computer cable

Connect the computer's display output port to the projector's Computer1 or Computer2 port. You can output audio from the projector's Audio1 or Audio2 port to the projector's Audio1 or Audio2 port using a commercially available audio cable.

2 When using the supplied or commercially available USB cable

Connect the computer's USB port to the projector's USB-B port. Audio from the computer is output from the projector with the p

3 When using a commercially available HDMI cable

Connect the computer's HDMI port to the projector's HDMI port. Audio from the computer is output from the projector with th

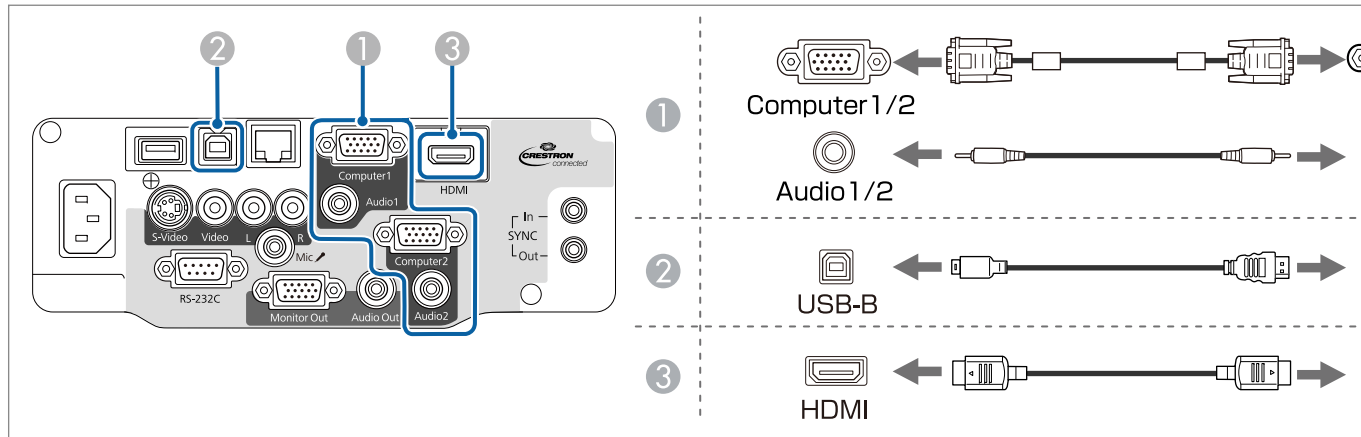

Connecting Equipment



- You can also set the port used for audio input from the Configuration menu.
 - ☛ **Extended** - **A/V Settings** - **Audio Output** [p.120](#)
- If audio is not output when an HDMI cable is connected, connect a commercially available audio cable to the audio input port you connected to from **HDMI Audio Output** from the Configuration menu.
 - ☛ **Extended** - **A/V Settings** - **HDMI Audio Output** [p.120](#)
- You can use a USB cable to connect the projector to a computer to project images from the computer. This feature is described in:
 - ☛ "Projecting with USB Display" [p.45](#)

Connecting Equipment

Connecting Image Sources

To project images from DVD players or VHS video and so on, connect to the projector using one of the following:

1 When using a commercially available video or S-video cable

Connect the video output port on the image source to the projector's Video port. Or, connect the S-video output port on the image source to the projector's Video port. Or, connect the S-video output port on the image source to the projector's Audio-L/R port.

2 When using the optional component video cable

☛ "Optional Accessories" p.172

Connect the component output port on the image source to the projector's Computer1 or Computer2 port. You can output audio from the image source to the projector's Audio1 or Audio2 port using a commercially available audio cable.

3 When using a commercially available HDMI cable

Connect the HDMI port on the image source to the projector's HDMI port. Audio from the image source is output from the projector's Audio1 or Audio2 port.

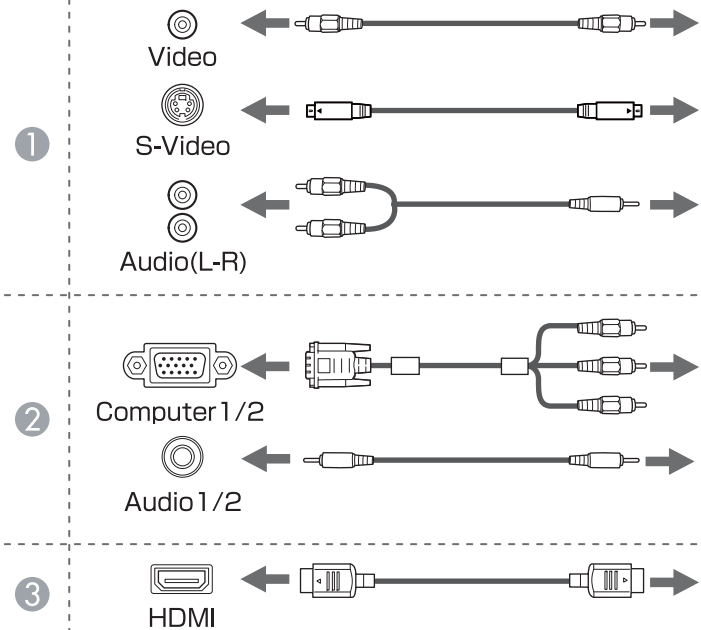
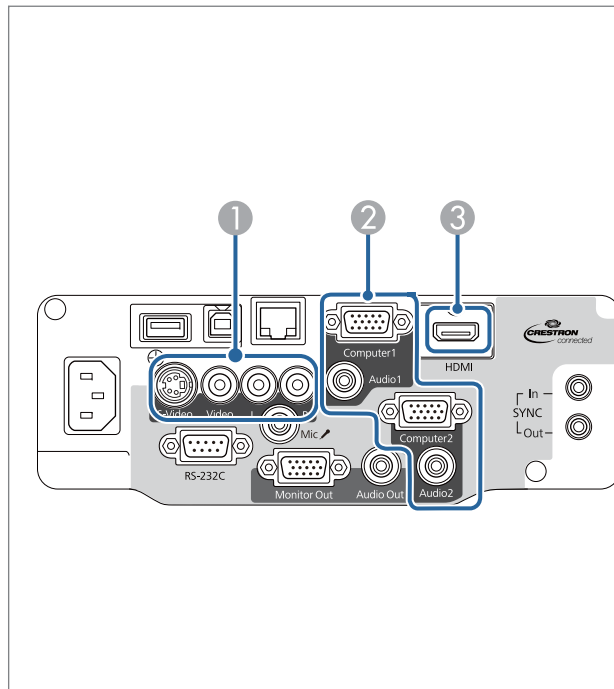

Connecting Equipment

Attention

- Turn off the equipment you want to connect before connecting. If the input source is on when you connect it to the device, the device could be damaged or could malfunction.
- If the orientation or shape of the plug differs, do not try to force it in. The device could be damaged or could malfunction.



- You can also set the port used for audio input from the Configuration menu.
 - ☛ **Extended** - A/V Settings - Audio Output [p.120](#)
- If audio is not output when an HDMI cable is connected, connect a commercially available audio cable to the audio input port you connected to from **HDMI Audio Output** from the Configuration menu.
 - ☛ **Extended** - A/V Settings - HDMI Audio Output [p.120](#)
- If the source you want to connect to has an unusually shaped port, use the cable supplied with the device or an adapter.
- When using a commercially available 2RCA(L/R)/stereo mini-pin audio cable, make sure it is labeled "No resist".

Connecting Equipment

Connecting USB Devices

You can connect devices such as USB memory, the optional Document Camera, and USB compatible hard disks. Using the USB cable supplied with the USB device, connect the USB device to the USB-A port on the projector.

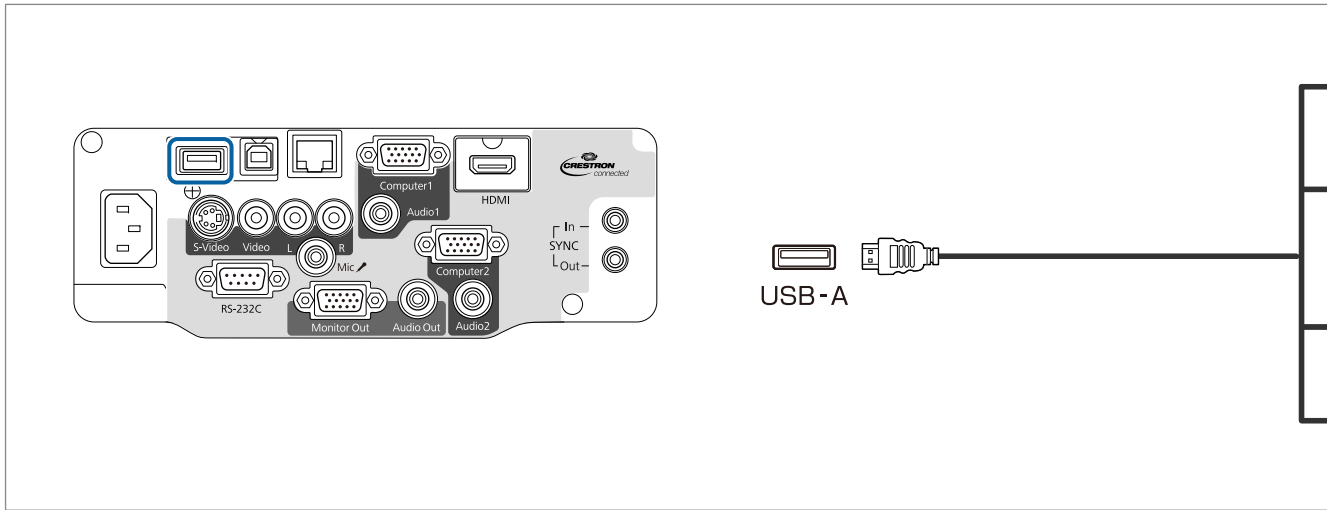

When the USB device is connected, you can project image files on the USB memory or digital camera using PC

☛ "Projecting Images Stored on a USB Storage Device (PC Free)" [p.85](#)

If the Document Camera is connected while projecting images from another input port, press the [USB] button on the button on the control panel, to switch to images from the Document Camera.

☛ "Automatically Detect Input Signals and Change the Projected Image (Source Search)" [p.43](#)



- While projecting images from a USB device, if you want to connect an audio output device, connect it to the
- You can also set the port used for audio input from the Configuration menu.
 - ☛ **Extended - A/V Settings - Audio Output** [p.120](#)

Connecting Equipment

Attention

- If you use a USB hub, operation may not be performed correctly. Devices such as digital cameras and USB devices should be connected directly to the projector.
- When connecting and using a USB-compatible hard disk, make sure you connect the AC adaptor supplied with the hard disk to a power outlet.
- Connect a digital camera or hard disk to the projector using a USB cable supplied with or specified for use with the device.
- Use a USB cable less than three meters in length. If the cable exceeds 3 m, PC Free may not function correctly.

Removing USB Devices

After finishing projecting, remove USB devices from the projector. For devices such as digital cameras or hard disks, turn off the projector.

Connecting a Microphone

You can output microphone audio from the projector's speaker by connecting a commercially available dynamic

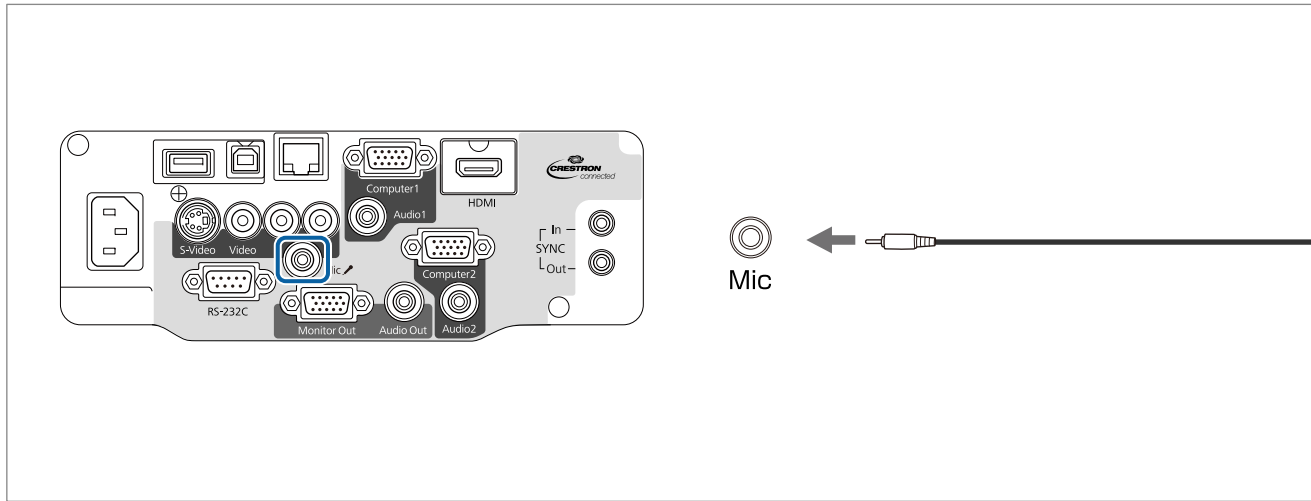

- Plug-in-power is not supported.
- Adjust **Mic Input Level** if the microphone audio is difficult to hear, or if it is too loud resulting in a crackling sound.
 - ☛ **Settings - Mic Input Level** [p.119](#)
- Make the following settings to output audio from a microphone when the projector is off.
 - Set **Standby Mode** to **Communication On**.
 - Set **A/V Output** to **Always On**.
 - ☛ **ECO - Standby Mode** [p.133](#)
 - ☛ **Extended - A/V Settings - A/V Output** [p.120](#)

Connecting Equipment

Connecting External Equipment

You can output images and audio by connecting an external monitor or speaker.

① **When outputting images to an external monitor**

Connect the external monitor to the projector's Monitor Out port using the cable supplied with the external monitor.

② **When outputting audio to an external speaker**

Connect the external speaker to the projector's Audio Out port using a commercially available audio cable.

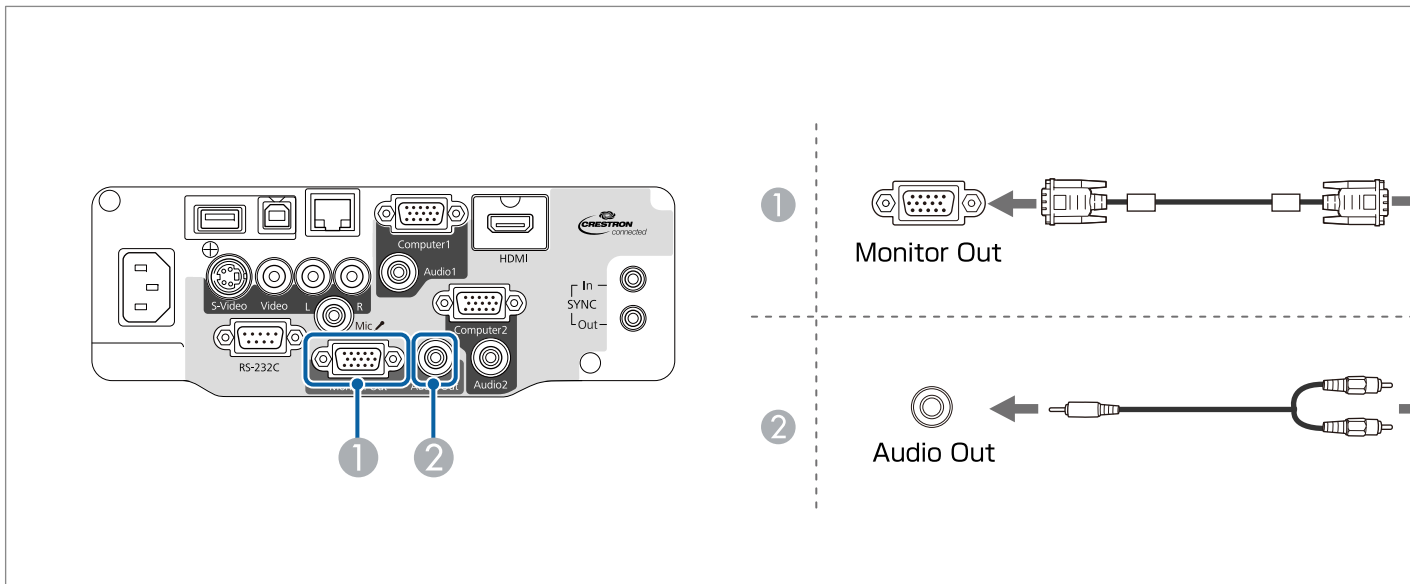

Connecting Equipment



- When **Standby Mode** is set to **Communication On**, you can perform the following operations even when the projector is in **Always On**.
 - Output images to an external monitor
 - Output audio (audio being input from the USB-A, USB-B, or LAN ports cannot be output)
- **ECO - Standby Mode** [p.133](#)
- **Extended - A/V Settings - A/V Output** [p.120](#)
- Only analog RGB signals from the Computer1 port can be output to an external monitor. You cannot output signals from the Computer2 port or the Video In port.
- Setting gauges for functions such as Keystone, Configuration Menu, or Help screens are not output to the external monitor.
- Content drawn using the interactive features is not displayed on an external monitor (EB-536Wi only). Content drawn using the interactive features can be displayed on an external monitor.
- When the audio cable jack is inserted into the Audio Out port, audio stops being output from the projector's internal speaker.

Connecting Equipment

Connecting a LAN Cable

Connect a LAN port on network hubs or other equipment to the projector's LAN port with a commercially available cable.

By connecting a computer to the projector over a network, you can project images and check the status of the

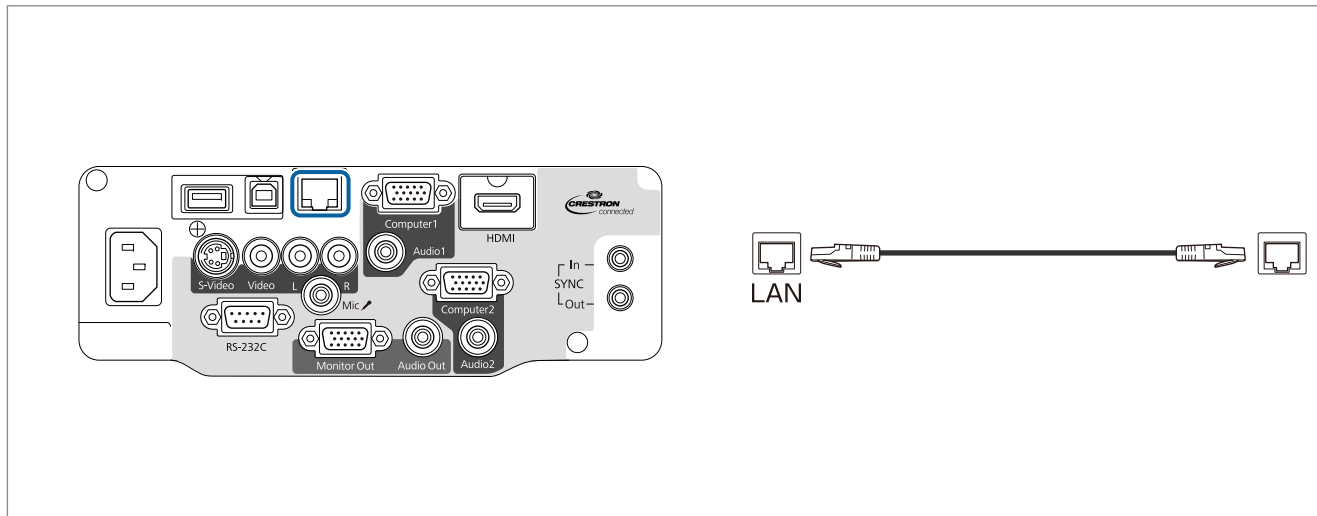

To prevent malfunctions, use a category 5 or higher shielded LAN cable.

Connecting Equipment

Installing the Optional Wireless LAN Unit

By installing the optional Wireless LAN unit, you can project a computer screen over a network.

Connect the Wireless LAN unit to the projector's USB-A port.



- When connecting to the network using wireless LAN, make sure you make network settings from the Configuration menu.
 - ☛ "Wireless LAN Menu" [p.127](#)
- If you normally leave the Wireless LAN unit installed, make sure you attach the supplied wireless LAN unit cover as a theft deterrent.
- When moving the projector, make sure you remove the Wireless LAN unit and cover for safety reasons.

- 1** Use a cross-head screwdriver to remove the screw that secures the wireless LAN unit cover.

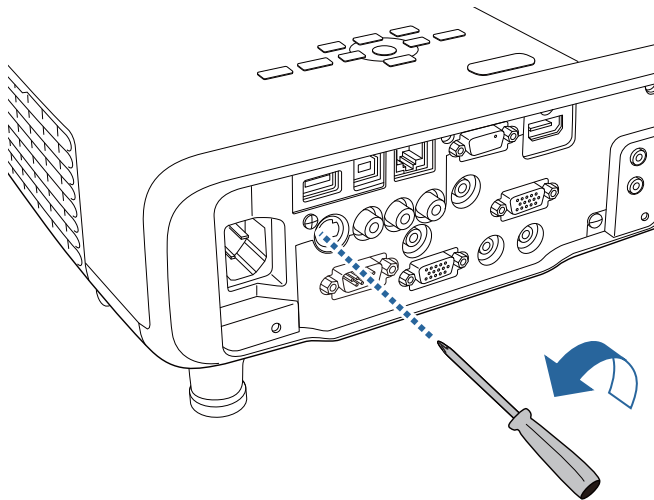

- 2** Connect the Wireless LAN unit to the USB-A port.

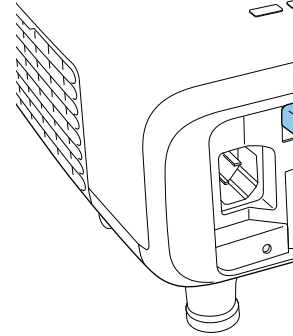

- 3** Attach the wireless LAN unit cover with the supplied screw.

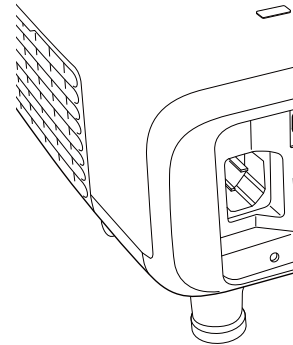

Connecting Equipment

Installing the Optional Quick Wireless Connection USB Key

When installing the optional Quick Wireless Connection USB Key, you need to remove the Wireless LAN unit first, and then connect the Quick Wireless Connection USB Key to the USB-A port.

- 1** Turn on the projector, and then press the [LAN] button on the remote control.
The LAN standby screen is displayed.
- 2** Check that the SSID and IP address information are displayed on the LAN standby screen, and then remove the Wireless LAN unit.
- 3** Connect the Quick Wireless Connection USB Key to the USB-A port.

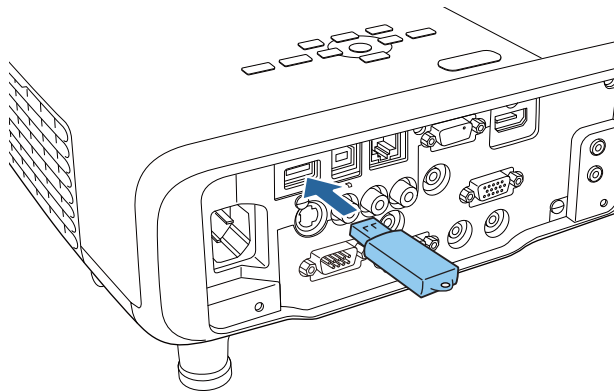

- 4** When the message "Network information update complete. Remove the Quick Wireless Connection USB Key Adapter." is displayed, remove the Quick Wireless Connection USB Key.
- 5** Reinstall the Wireless LAN unit on the projector.

- 6** Connect the Quick Wireless Connection USB Key to the USB-A port of the projector you are using.
For the steps from here on, refer to the Quick Wireless Connection screen.

Connecting Equipment

Connecting Multiple Projectors (EB-536Wi only)

When using the interactive features in the same room as multiple versions of the same projector, you need to connect the Remote Control Cable Set (ELPKC28) to the SYNC port on each projector. Interactive pen operations are stabilized by linking the projectors.

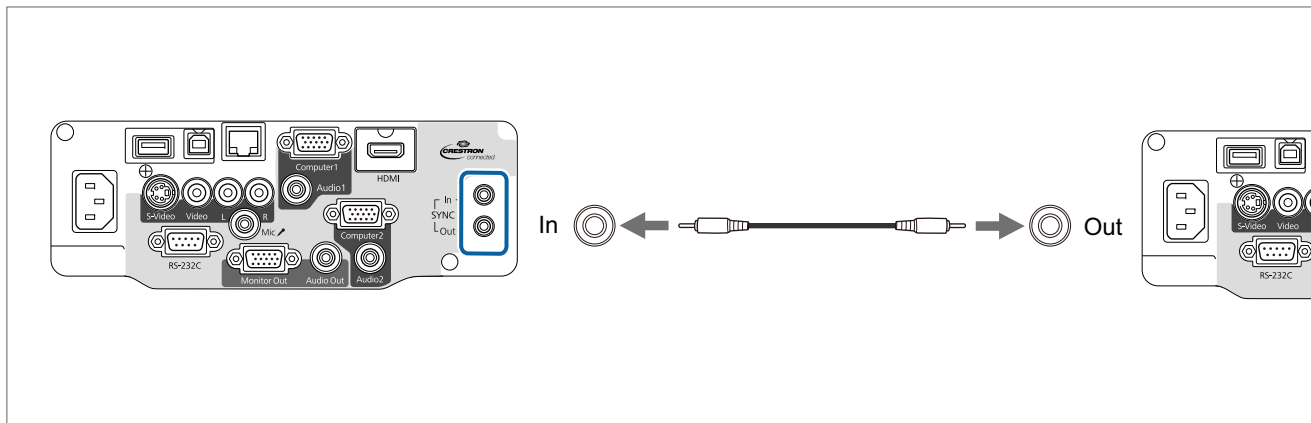

The SYNC port has an IN and OUT socket. When you connect one end of the Remote control cable set to an IN socket.

After connecting the cables, set **Sync of Projectors** to **Wired** from the Configuration menu.

☛ **Extended - Easy Interactive Function - General - Advanced - Sync of Projectors** [p.123](#)

Connecting Equipment



- When connecting three or more projectors, you do not need to connect the first projector to the last projector.

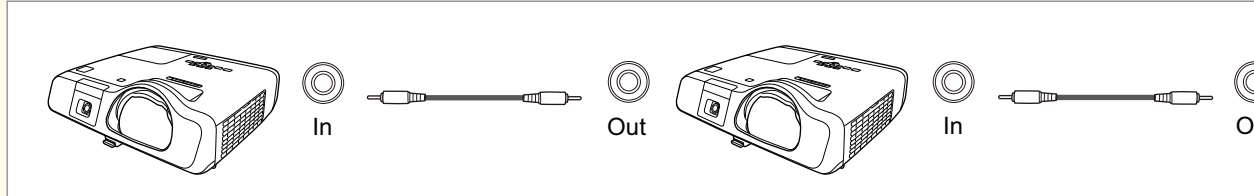

- When using the projector in the same room as another projector that does not support cable connection, set **Wired Sync Mode** in the **Configuration** menu.
 - ☛ **Extended - Easy Interactive Function - General - Advanced - Wired Sync Mode** [p.123](#)
- If you do not have the optional Remote control cable set, change the **Distance of Projectors** setting from the **Configuration** menu.
 - ☛ **Extended - Easy Interactive Function - General - Advanced - Distance of Projectors** [p.123](#)

Basic Usage

This chapter explains how to project and adjust images.

Projecting Images

Turning On the Projector

Connect the computer or video equipment you want to use with the projector before you turn on the projector.

☛ "Connecting Equipment" [p.26](#)

- 1** Remove the lens cover.
- 2** Connect the projector to an electrical outlet with the power cord.

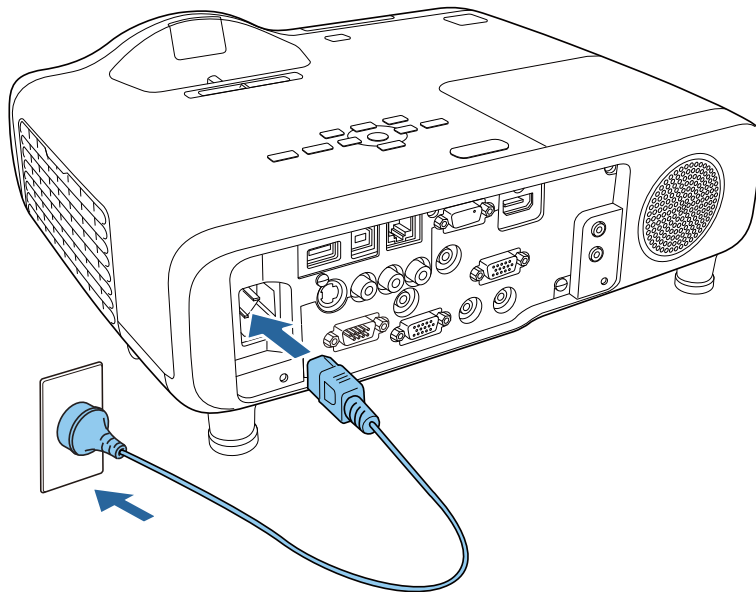

The projector's power indicator turns blue (standby status). In standby status, power is being supplied to the projector, however it is not turned on.

- 3** Press the [⏻] power button on the remote control to turn on the projector. Check that a beep sounds (warm-up status). When the projector stops flashing and remains on, the projector is ready to use.

Try one of the following if the projector does not project an image:

- Turn on the connected computer.
- Change the screen output from the projector to the computer.
- Insert a DVD or other video source into the projector.
- Press the [Source Search] button on the remote control to detect the input source.
☛ "Automatically Detect Input Source (Source Search)" [p.43](#)
- On the remote control, press the [Input] button.
☛ "Switching to the Target Input Source" [p.43](#)

Projecting Images



Warning

- Do not look into the projector's lens during projection. Doing so could damage your eyes. Take particular care when there are children present.
- During projection, do not block the light from the projector with the lens cover or a book and so on. If the light from the projector is blocked, the area on which the light shines becomes hot which could cause the lens cover to melt, burn, or start a fire. Also, the lens may get hot due to the reflected light which could cause the projector to malfunction. To stop projection, use the A/V Mute function, or turn off the projector.
- A mercury lamp with high internal pressure is used as the projector's light source. If the lamp is subjected to vibrations, shocks, or if it is used for an overly extended length of time, the lamp may break or it may not turn on. If the lamp explodes, gases may escape and small fragments of glass may be scattered which could cause an injury. Be sure to observe the instructions below.
 - Do not disassemble or damage the lamp or subject it to any impacts.
 - Do not bring your face close to the projector while it is in use.
 - Particular care should be taken when the projector is installed to a ceiling, as small pieces of glass may fall down when the lamp cover is removed. (When cleaning the projector or replacing the lamp yourself, be very careful not to allow such pieces of glass to get into the eyes or mouth.)If the lamp breaks, ventilate the area immediately, and contact a doctor if any fragments of broken glass are inhaled or get into the eyes or mouth.



- When **Direct Power On** is set to **On** from the **Extended** menu, the projector turns on automatically when the power cord is connected. When the power cord is plugged in, note that the projector turns on automatically in cases such as a power outage being restored.
 - ☛ **Extended - Operation - Direct Power On** [p.120](#)
- When **Auto Power On** is set to **Computer1** in the **Extended** menu, when an image signal is being input into the projector's Computer1 input port, the power turns on automatically. (Only when **Standby Mode** is set to **Communication On** in the **ECO** menu.)
 - ☛ **Extended - Operation - Auto Power On** [p.120](#)

Turning Off the Projector



Turn off this product when you are done using the projector. The lamp's operating time is limited. The Configuration menu setting **Brightness** decreases over time.

1

Press the [⏻] button on the projector. The shutdown confirmation screen appears.

Power Off?

Yes: Press [Y]
No : Press [N]

2

Press the [⏻] power button on the projector. (The status indicator turns off.)

After the beep sounds twice, the projector is powered off. The status indicator turns off.



Since this projector has a lamp, please do not touch the lamp or put it away or move it until it has cooled down.

3

Unplug the power cord from the projector and the power outlet.

Projecting Images

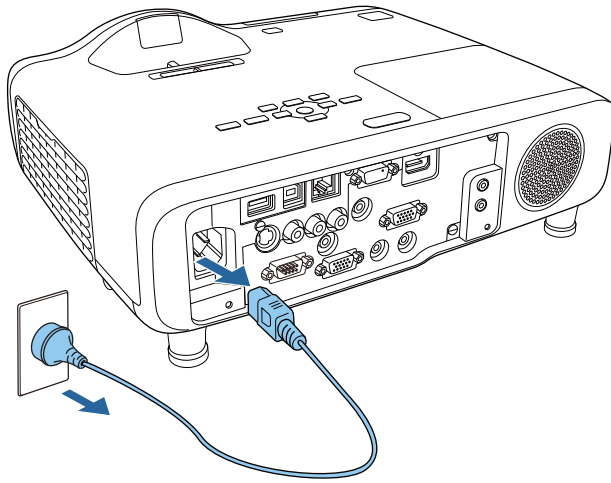

- 4** Attach the lens cover.

Automatically Detect In the Projected Image (S

Press the [Source Search] button receiving an image.

Using the remote control

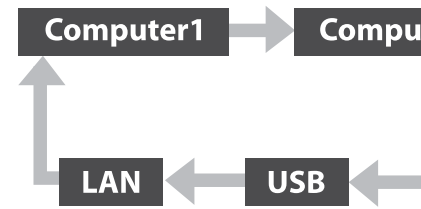
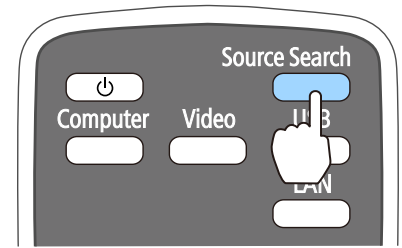

When two or more image source button until the target image is

When your video equipment is of this operation.

Projecting Images



- You can make settings so that images are projected from the same input port the next time the projector is turned on.
 - Extended - Operation - Startup Source Search p.120
- The following screen is displayed while no image signals are input.

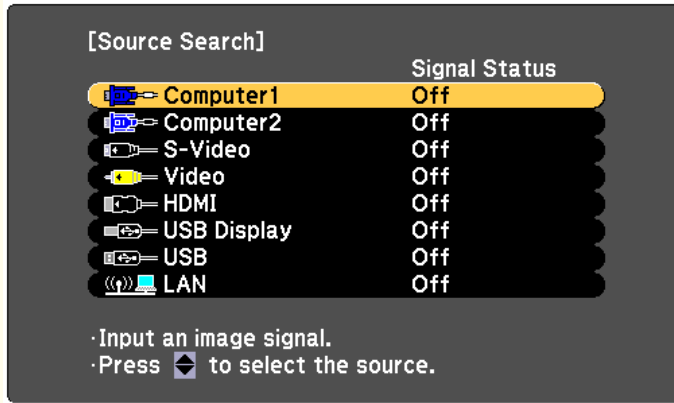

Switching to the Target Control

You can change directly to the buttons on the remote control.

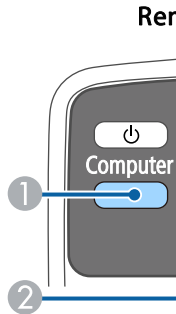

- Each time the button is pressed, the projector switches to the image from the following sources:
 - Computer1 port
 - Computer2 port
- Each time the button is pressed, the projector switches to the image from the following sources:
 - S-Video port
 - Video port
 - HDMI port
- Each time the button is pressed, the projector switches to the image from the following sources:
 - USB Display
 - Images from the device
- Switches to the image from the device

Projecting Images

Projecting with USB Display

You can use the supplied or a commercially available USB cable to connect the projector to a computer to project images from the computer.

You can send the computer's audio with the projected image.

When using EB-536Wi, set **USB Type B** to **USB Display/Easy Interactive Function** or **Wireless Mouse/USB Display** to use USB Display.

☛ **Extended - USB Type B** [p.120](#)

System requirements

For Windows

OS	Windows 2000*1	
	Windows XP	Professional 32 bit Home Edition 32 bit Tablet PC Edition 32 bit
	Windows Vista	Ultimate 32 bit Enterprise 32 bit Business 32 bit Home Premium 32 bit Home Basic 32 bit
	Windows 7	Ultimate 32/64 bit Enterprise 32/64 bit Professional 32/64 bit Home Premium 32/64 bit Home Basic 32 bit Starter 32 bit
	Windows 8	Windows 8 32/64 bit Windows 8 Pro 32/64 bit Windows 8 Enterprise 32/64 bit

	Windows 8
CPU	Mobile Pen Recommend
Amount of Memory	256 MB or Recommend
Hard Disk Space	20 MB or
Display	Resolution o 1920 x 1200 Display col

*1 Service Pack 4 only

For OS X

OS	Mac OS X 10 Mac OS X 10 OS X 10.7.x OS X 10.8.x OS X 10.9.x
CPU	Power PC G Recommend
Amount of Memory	512 MB or m
Hard Disk Space	20 MB or m
Display	Resolution o 1200. Display colo

Projecting Images

Connecting for the First Time

The first time you connect the projector and the computer using the USB cable, the driver needs to be installed. The procedure is different for Windows and OS X.



- You do not need to install the driver the next time you connect.
- When inputting images from multiple sources, change the input source to USB Display.
- If you use a USB hub, the connection may not operate correctly. Connect the USB cable directly to the projector.
- You cannot change option settings while using USB Display.

For Windows

- 1 Connect the computer's USB port to the projector's USB-B port using the supplied or a commercially available USB cable.



For Windows 2000 or Windows XP, a message asking you if you want to restart your computer may be displayed. Select **No**.

For Windows 2000

Double-click **Computer - EPSON PJ_UD - EMP_UDSE.EXE**.

For Windows XP

Driver installation starts automatically.

For Windows Vista/Windows 7/Windows 8/Windows 8.1

When the dialog box is displayed, click run **EMP_UDSE.EXE**.

- 2 When the License Agreement screen is displayed, click **Agree**.

3

Computer images are projected. It may take a while before computer images are projected. Do not disconnect the USB cable.

4

Disconnect the USB cable. When disconnecting the USB cable, click **Remove Hardware**.



- If it is not installed, click **EPSON PJ_UD - EPSON PJ_UD - EMP_UDSE.EXE**.
- If nothing is projected, click **Projector - Epson Projector - Epson Projector Ver.x.xx** on your computer.
- When using a computer with administrator authority, a Windows security message may be displayed. Click **Yes** to allow Windows to the projector. If the message is not displayed, click **Yes** again. For more details, click [Epson Projector](#).

For OS X

1

Connect the computer's USB port to the projector's USB-B port using the supplied or a commercially available USB cable. The Setup folder of USB Display is displayed.

2

Double-click the **USB Display** folder.

3

Follow the on-screen instructions.

Projecting Images

- When the License Agreement screen is displayed, click **Agree**. Enter the administrator authority password and start the installation. When the installation is complete, the USB Display icon is displayed in the Dock and menu bar.
- Computer images are projected. It may take a while before computer images are projected. Until computer images are projected, leave the equipment as it is and do not disconnect the USB cable or turn off the power to the projector.
- When you have finished, select **Disconnect** from the menu bar or from the **USB Display** icon on the Dock. You can then disconnect the USB cable.



- If the USB Display Setup folder is not displayed automatically in the Finder, double-click **EPSON PJ_UD - USB Display Installer** on your computer.
- If nothing is projected for some reason, click the **USB Display** icon in the Dock.
- If there is no **USB Display** icon on the Dock, double-click **USB Display** in the application folder.
- If you select **Exit** from the **USB Display** icon on the Dock, USB Display does not start automatically when you connect the USB cable.

Uninstalling

For Windows 2000

- Click **Start**, select **Settings**, and then click **Control Panel**.
- Double-click **Add/Remove Programs**.
- Click **Change or Remove Programs**.
- Select **Epson USB Display** and click **Change/Remove**.

For Windows XP

- Click **Start**, and then click **Control Panel**.
- Double-click **Add or Remove Programs**.
- Select **Epson USB Display**.

For Windows Vista/Windows 7

- Click **Start**, and then click **Control Panel**.
- Click **Uninstall a program**.
- Select **Epson USB Display**.

For Windows 8/Windows 8.1

- Open Charms, and then click **Epson USB Display Ver.**
- Select **Uninstall** from the Charms.
- Select **Epson USB Display**.
- Follow the on-screen instructions.

For OS X

- Double-click **Applications**.
- Run **USB Display Uninstall**.

Adjusting Projected Images

Correcting Keystone Distortion

You can correct keystone distortion using one of the following methods.

- Correcting manually (H/V-Keystone)
Manually correct distortion in the horizontal and vertical directions independently.

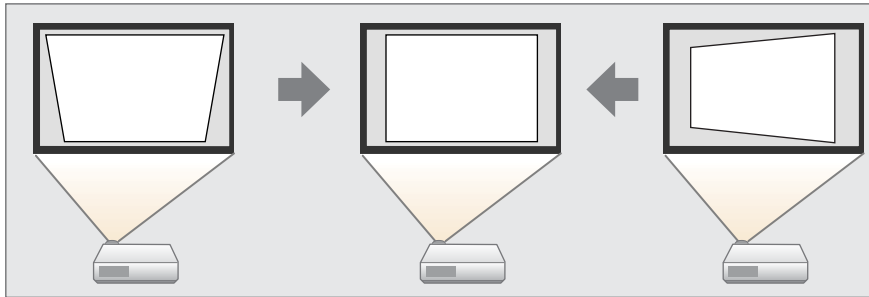

- Correcting manually (Quick Corner)
Manually correct the four corners independently.

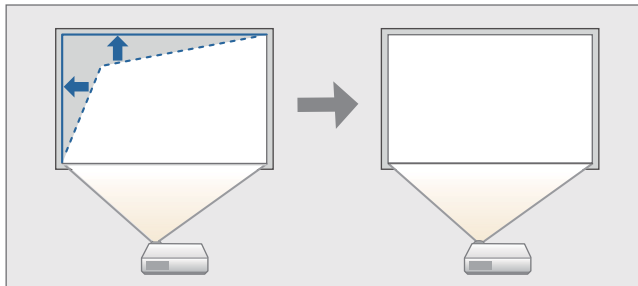

When using EB-536Wi, you can correct keystone distortion.

- Correcting automatically (Auto)
Automatically corrects vertical keystone distortion.
- Correcting manually (H-Keystone)
Manually corrects horizontal keystone distortion using the H-Keystone adjuster.

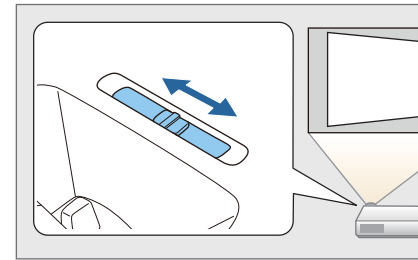

When you correct keystone distortion, the image resolution is reduced.

Adjusting Projected Images

Correcting Manually

You can manually correct keystone distortion.

You can use H/V-Keystone to correct the projected image under the following conditions.

Correction angle for EB-536Wi: approx. 5° right and left/approx. 7° up and down

Correction angle for EB-535W/EB-525W/EB-530/EB-520: approx. 15° right and left/approx. 15° up and down

H/V-Keystone

Manually correct distortion in the horizontal and vertical directions independently.

- 1 Press the [∇] or [∇] button on the control panel during projection to display the Keystone screen.

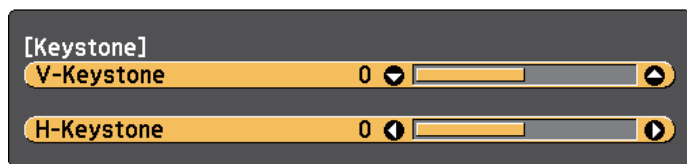

- 2 Press the following buttons to correct keystone distortion.
Press the [∇] or [∇] button to correct vertical distortion.

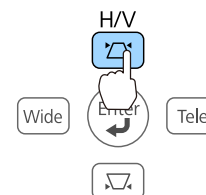
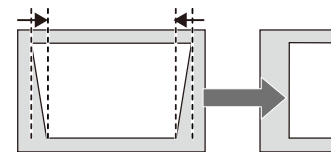

Press the [Wide] or [Tele]

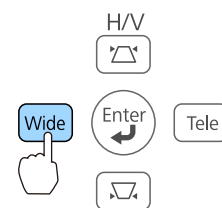
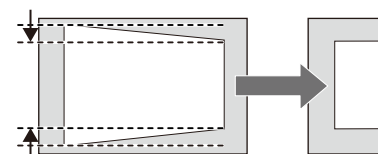

You can also set H/V-Ke

Settings - Keystone

Quick Corner

This allows you to manually correct the projected image separately.

Adjusting Projected Images

- 1 Press the [Menu] button while projecting.
☛ "Using the Configuration Menu" p.113

Using the remote control

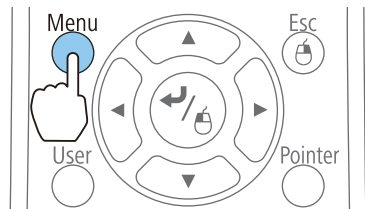

Using the control panel

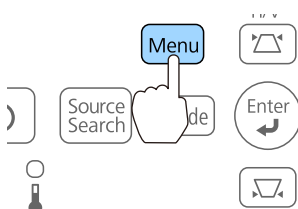

- 2 Select **Keystone** from **Settings**.

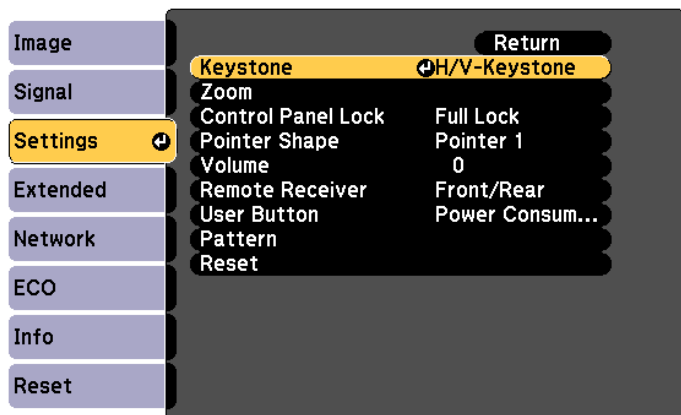

- 3 Select **Quick Corner**, and then press the [↶] button.

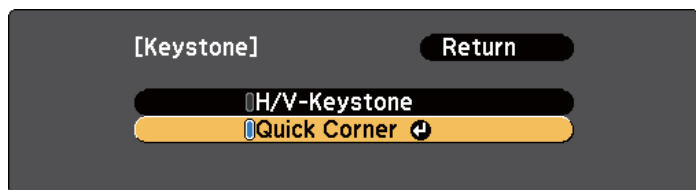

- 4 Select the corner to correct. Press the [↶] and [↷] buttons on the remote control or the [Left] and [Right] buttons on the control panel.

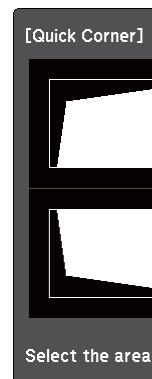

- 5 Correct the position of the image by pressing the [↶] and [↷] buttons on the remote control or the [Left] and [Right] buttons on the control panel. When you press the [↶] or [↷] button, the [Quick Corner] screen is displayed. If the message "Cannot adjust" is displayed, you cannot adjust the image. The gray triangle indicates the corner to be adjusted.

Adjusting Projected Images

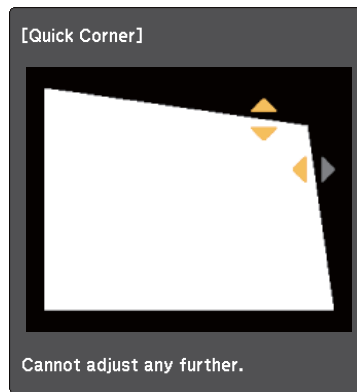

6 Repeat procedures 4 and 5 as needed to adjust any remaining corners.

7 Press the [Esc] button to exit the correction menu.

Because **Keystone** was changed to **Quick Corner**, the corner selection screen shown in step 4 is displayed the next time you press the [↵] or [↘] button on the control panel. Change **Keystone** to **H/V-Keystone** if you want to perform horizontal and vertical correction using the [↵] or [↘] button on the control panel.

☛ **Settings - Keystone - H/V-Keystone** [p.119](#)



If the [Esc] button is pressed, the corner selection screen shown in the following screen is displayed.

[Keystone]

Reset
Switch

Reset Quick Corner
corrections.

Switch to H/V-Keystone
H/V-Keystone.

☛ "Settings Menu"

H-Keystone Adjuster (EB-536Wi only)

Move the horizontal keystone adjuster to the right to perform horizontal keystone correction.

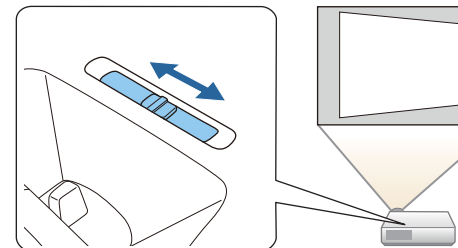

• When using H-Keystone, the H-Keystone adjuster must be turned On.

☛ **Settings - Keystone** [p.119](#)

• You can also correct keystone using H/V-Keystone.

Adjusting Projected Images

Correcting Automatically (EB-536Wi only)

Auto V-Keystone

When the projector detects any movement, for example when it is installed, moved, or tilted, it automatically corrects vertical keystone distortion. This function is called Auto V-Keystone.

When the projector remains still for about two seconds after it detects movement, it displays a screen for adjustment and then automatically corrects the projected image.

You can use Auto V-Keystone to correct the projected image under the following conditions.

Correction angle: approx. 7° up and down



- Auto V-Keystone works only when **Projection** is set to **Front** from the Configuration menu.
 - ☛ **Extended - Projection** p.120
- If you do not want to enable Auto V-Keystone, set **Auto V-Keystone** to **Off**.
 - ☛ **Settings - Keystone - H/V-Keystone - Auto V-Keystone** p.119
- If the projector is moved slightly, motions may not be detected and Auto V-Keystone may not be performed.

Adjusting the Image Size

Press the [Wide] and [Tele] buttons on the control panel to adjust the size of the projected image.

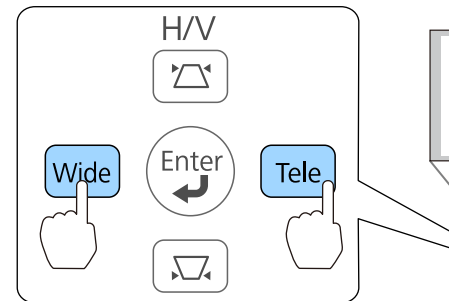

You can also make adjustments.
☛ **Settings - Zoom** p.119

Adjusting the Image Position

Press the foot adjust lever to extend or retract the rear feet.

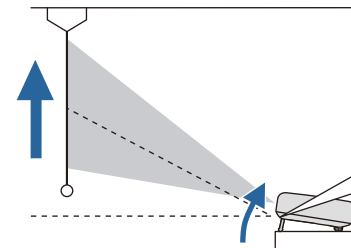

The larger the angle of tilt of the projector so that it only projects the image.

Adjusting the Horizontal Image

Extend and retract the rear feet to adjust the horizontal position of the projected image.

Adjusting Projected Images

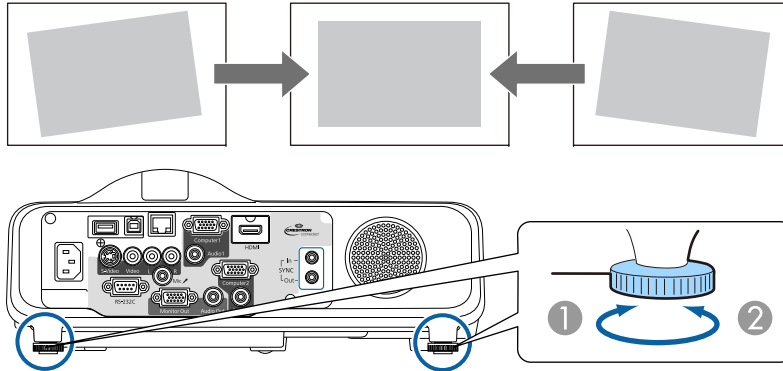

- ① Extend the rear foot.
- ② Retract the rear foot.

Correcting the Focus

You can correct the focus using the focus ring.

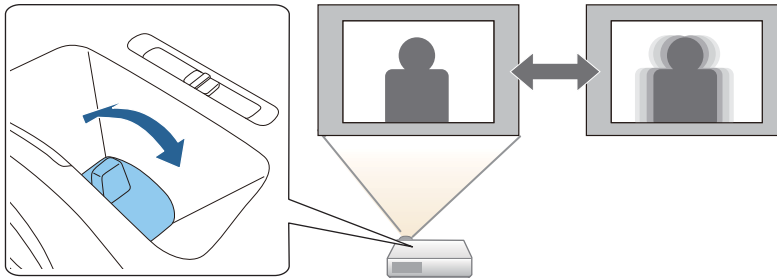

Adjusting the Volume

You can adjust the volume using one of the following methods.

- Press the [Volume] buttons on the remote control.
 - [Volume Down] Decreases the volume.
 - [Volume Up] Increases the volume.

Remote control

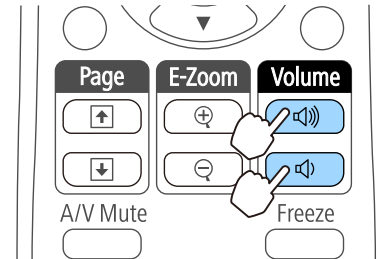

- Adjust the volume from the Control Panel.
 - [Settings - Volume p.119](#)

Caution

Do not start when the volume is high. A sudden increase in volume may cause hearing damage. Increase the volume before powering off, so that the volume does not increase.

Selecting the Projection Mode

You can easily obtain the optimal projection setting that best corresponds to the brightness of the image varies depending on the projection mode.

Mode	
Dynamic	Ideal for

Adjusting Projected Images

Mode	Application
Presentation	Ideal for making presentations using color materials in a bright room. Also ideal for watching TV programs with vivid images in sharp contrast.
Theatre	Ideal for watching films in a dark room. Gives images a natural tone.
sRGB	Ideal for reproducing images that conform to the <u>sRGB</u> color standard. Ideal for projecting still pictures, such as photos.
Blackboard	Even if you are projecting onto a blackboard (greenboard), this setting gives your images a natural tint, just like when projecting onto a screen.

Each time you press the [Color Mode] button, the Color Mode name is displayed on the screen and the Color Mode changes.

Remote control

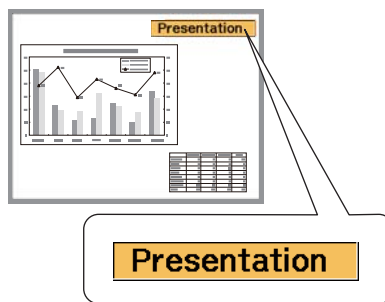
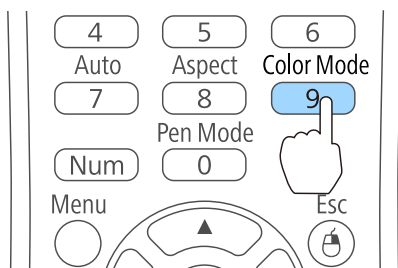

You can set Color Mode from the Configuration menu.

➡ **Image - Color Mode** p.116

Setting Auto Iris

By automatically setting the luminance of the displayed image, it lets you enjoy

1 Press the [Menu] button.

➡ "Using the Configuration menu"

Using the remote control

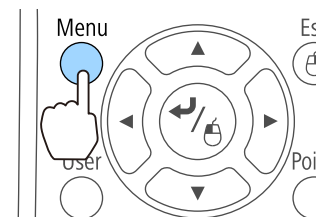

2 Select **Auto Iris** from **Image**

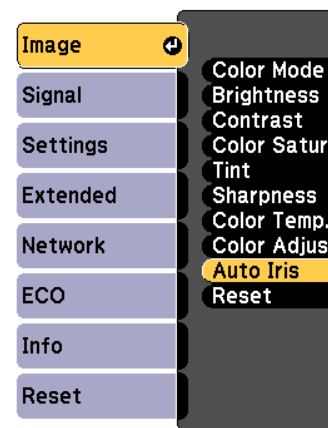

3 Select **Normal** or **High S**

The setting is stored for

Adjusting Projected Images

4 Press the [Menu] button to finish making settings.



- **Auto Iris** can only be set when the **Color Mode** is set to **Dynamic** or **Theatre**.
- When **Auto Iris** is set to **Normal** or **High Speed**, **Light Optimizer** is enabled (this is also enabled when **Light Optimizer** is set to **Off** and the settings cannot be changed).

Changing the Aspect Ratio of the Projected Image

You can change the Aspect Ratio of the projected image to suit the type, the ratio of height and width, and the resolution of the input signals.

Available aspect modes vary depending on the image signal currently being projected.

Changing Methods

Each time you press the [Aspect] button on the remote control, the aspect mode name is displayed on the screen and the aspect ratio changes.

Remote control

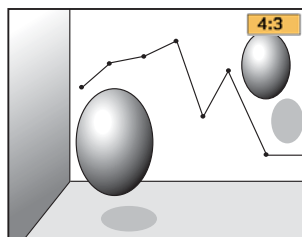
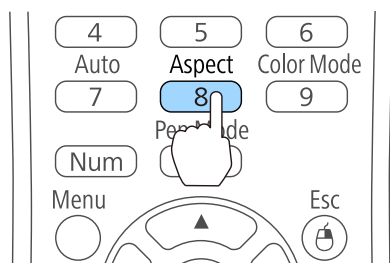

You can set the aspect ratio from the Configuration menu.

➤ **Signal - Aspect** p.117

Changing the Aspect Mode (E)

Projecting images from video equipment

Each time the [Aspect] button on the remote control is pressed, the aspect mode changes in the order **Normal**, **16:9**, **Full**, **Zoom**, and **Native**.

Example: 1080p signal input (re)

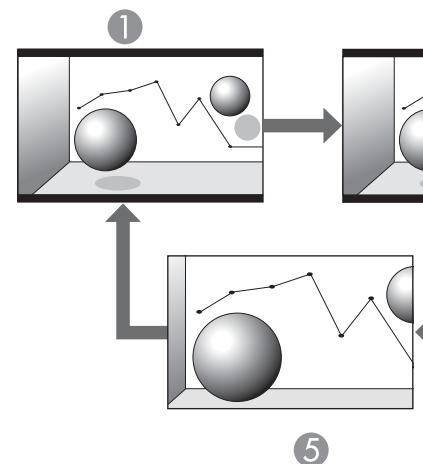

- 1 Normal or Auto
- 2 16:9
- 3 Full
- 4 Zoom
- 5 Native

Adjusting Projected Images

Projecting Images from a Computer

The following shows projection examples for each aspect mode.

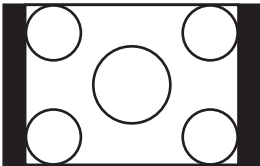
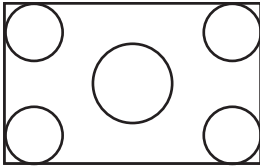
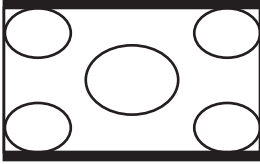
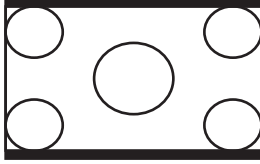
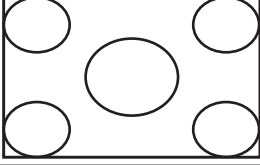
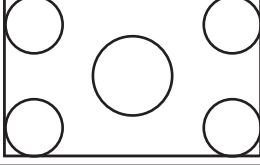
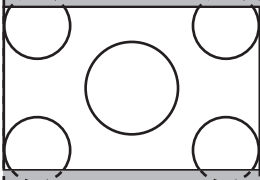
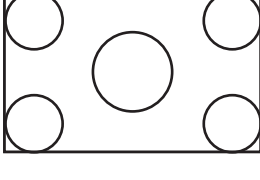
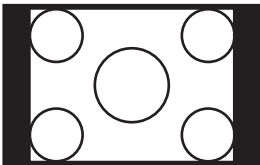
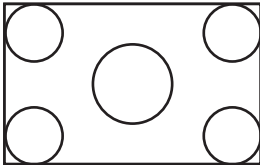
Aspect Mode	Input Signal	
	XGA 1024X768(4:3)	WXGA 1280X800(16:10)
Normal		
16:9		
Full		
Zoom		
Native		



If parts of the image are cut off when the aspect mode is set to **Normal** from the Control Panel, change the aspect mode to **Full** from the computer panel.

 **Signal - Resolution**

Changing the Aspect Mode (E)

Projecting Images from Video Equipment

Each time the [Aspect] button is pressed, the aspect mode changes in the order **4:3** and **16:9**.

When inputting a 720p/1080i signal, a zoom is applied (the right and left sides of the image are zoomed in).

Example: 720p signal input (resolution 1280x720)

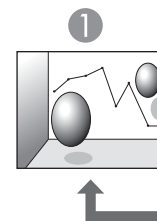

① 4:3

② 16:9

Projecting Images from the HDMI Port

Each time the [Aspect] button is pressed, the aspect mode changes in the order **Auto**, **4:3**, and **16:9**.

Example: 1080p signal input (resolution 1920x1080)

Adjusting Projected Images

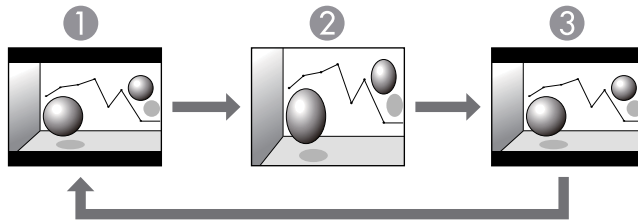

- ① Auto
- ② 4:3
- ③ 16:9



If parts of the image are
or **Normal** from the Com
computer panel.

☞ **Signal - Resolution**

Projecting Images from a Computer

Each time the [Aspect] button is pressed, the aspect mode changes in the order **Normal**, **4:3**, and **16:9**.

The following shows projection examples for each aspect mode.

Aspect Mode	Input Signal	
	XGA 1024X768(4:3)	WXGA 1280X800(16:10)
Normal		
4:3		
16:9		

Using the Interactive Features (EB-536Wi only)

Follow the instructions in these sections to use the interactive features.

Interactive Feature Modes

The interactive features turn any wall into an interactive whiteboard, either with or without a computer. Three interactive modes are available and it's easy to shift between each mode:

- In annotation mode, you can use interactive pens to add notes to content projected from a computer, tablet, document camera, or other source. This helps you emphasize projected information or include additional notes for more effective lessons or presentations.



- In whiteboard mode, you can use the system as a projected "whiteboard." You do not need any additional software to use it.

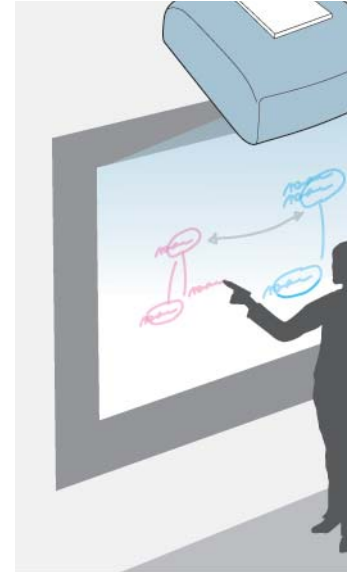

Interactive Feature Modes

- In computer interactive mode, you can use interactive pens as you would use a mouse. This allows you to navigate, select, and scroll through content projected from your computer.

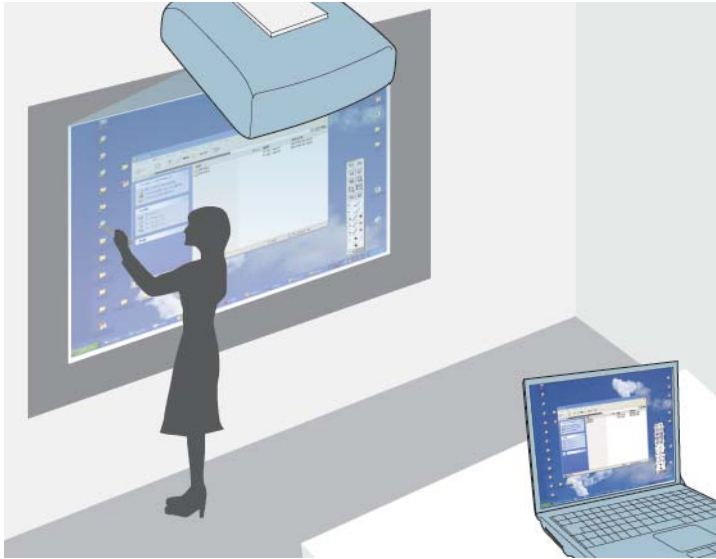

You can also use the Easy Interactive Tools software to provide additional interactive features, such as saving your annotations, and then printing them. See the *Easy Interactive Tools Operation Guide* built into the software for instructions.

Drawing on a Projected Image (Annotation Mode)

Annotation mode lets you project from a computer, tablet, video device, or other source and add notes to your projected content using the interactive pens. You can use both pens at the same time.

- 1** Turn on the projector.

- 2** Make sure you have called the projector.

☛ "Pen Calibration" p.68

- 3** Project an image from a

- 4** Hold an interactive pen







- 5** To write or draw, tap the

You see the toolbar on the



Interactive Feature Modes



- You can also control the projector from the projected screen by using the projector control toolbar displayed on the screen. Tap the  or  icon if the projector control toolbar is not displayed.
- You can move the  and  toolbar tabs up and down, and the  or  toolbar tab right and left.

You can write on the projected screen.

☞ "Using the Interactive Pens" [p.67](#)

☞ "Interacting with the Screen" [p.74](#)

Using the Projected Screen as a Whiteboard (Whiteboard Mode)

You can use the interactive pens to write or draw on the projection surface just as you would on a chalkboard or dry erase board. You can use both pens at the same time.

- 1** Turn on the projector.
- 2** Make sure you have calibrated the first time you use your projector.
 - ☞ "Pen Calibration" [p.68](#)

- 3** Hold an interactive pen close to the projected screen.





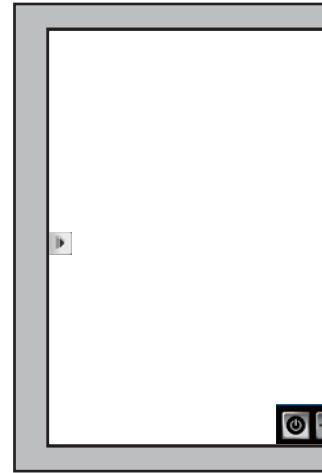

- 4** Tap the  or  toolbar tab.

The toolbar is displayed.

5

Tap the  icon on the screen.
You see the whiteboard screen.



- You can also control the projector from the projected screen by using the projector control toolbar displayed on the screen. Tap the  or  icon if the projector control toolbar is not displayed.
- You can move the  and the  toolbar tabs up and down, and the  or  toolbar tab right and left.

6

To write or draw on the projected screen, tap the screen with the pen on the left side.

☞ "Using the Interactive Pens" [p.67](#)

☞ "Interacting with the Screen" [p.74](#)

Interactive Feature Modes



You can also use the Easy Interactive Tools software to provide additional interactive features, such as treating the drawing area as a page, and creating multiple pages to draw on. See the *Easy Interactive Tools Operation Guide* for instructions.

Controlling a Computer from the Projected Screen (Computer Interactive Mode)

You can navigate, select, and interact with your computer programs from the projected screen using the interactive pens, just as you would with a mouse.

Computer Interactive Mode System Requirements

Your computer must use one of the following operating systems to use the computer interactive mode.

Windows	Windows XP Service Pack 2 and Service Pack 3 <ul style="list-style-type: none">• Professional (32 bit)• Home Edition (32 bit)• Tablet PC Edition (32 bit)
	Windows Vista Service Pack 2 <ul style="list-style-type: none">• Ultimate (32 bit)• Enterprise (32 bit)• Business (32 bit)• Home Premium (32 bit)• Home Basic (32 bit)
	Windows 7 Service Pack 1 <ul style="list-style-type: none">• Ultimate (32/64 bit)• Enterprise (32/64 bit)• Professional (32/64 bit)• Home Premium (32/64 bit)

	Windows <ul style="list-style-type: none">• Windows• Windows• Windows
	Windows <ul style="list-style-type: none">• Windows• Windows• Windows
Mac	OS X <ul style="list-style-type: none">• Mac OS X• Mac OS X• OS X• OS X• OS X
Ubuntu	Ubuntu <ul style="list-style-type: none">• 12.04• 12.10• 13.04• 13.10• 14.04

Using Computer Interactive Mode

You can control your computer from the projected screen using the computer interactive mode.

To use computer interactive mode, connect the computer to the projector with the supplied USB cable.

For OS X, you need to install the Easy Interactive Tools software in interactive mode.

Interactive Feature Modes



- When you use multiple displays with Windows 7 and use interactive features on the secondary display, make the following settings:
 - Set the **Pen Operation Mode** setting to **One User/Pen** in the **Easy Interactive Function** setting in the projector's **Extended** menu.
 - Go to **Control Panel > Hardware and Sound > Table PC Settings > Setup** to launch the setup program and configure the interactive features.
- If you set up a third display, you cannot use interactive features with that display.
You cannot write or draw across multiple screens.
- To use computer interactive mode over a network, you need to install EasyMP Network Projection version 2.85 or later (for Windows) or 2.83 or later (for OS X), or Quick Wireless version 1.32 or later.

1 If you are using OS X, install the Easy Interactive Driver on your computer the first time you use the interactive features.

☛ "Easy Interactive Driver System Requirements (OS X only)" [p.65](#)

☛ "Installing Easy Interactive Driver on OS X" [p.65](#)

2 Connect the projector to your computer using a USB cable.



You do not need a USB cable when using computer interactive mode over a network.

☛ "Using the Interactive Features over a Network" [p.80](#)

3 Turn on the projector.

4 Project your computer's desktop.

5 Press the [Menu] button, select the **Extended** menu, and press the [Enter] button.

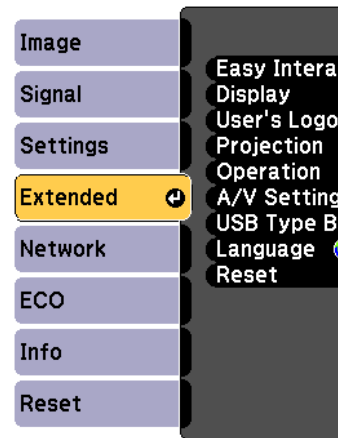

6 Select the **USB Type B** option.

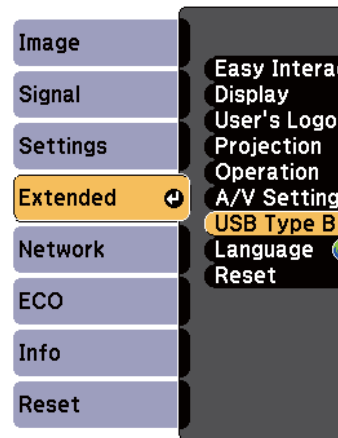

7 Select one of the following options:

- When projecting using a computer, select **Easy Interactive Function**.

Interactive Feature Modes

- To use computer interactive mode and USB Display at the same time, select **USB Display/Easy Interactive Function**.



When projecting using USB Display, response time may be slower.

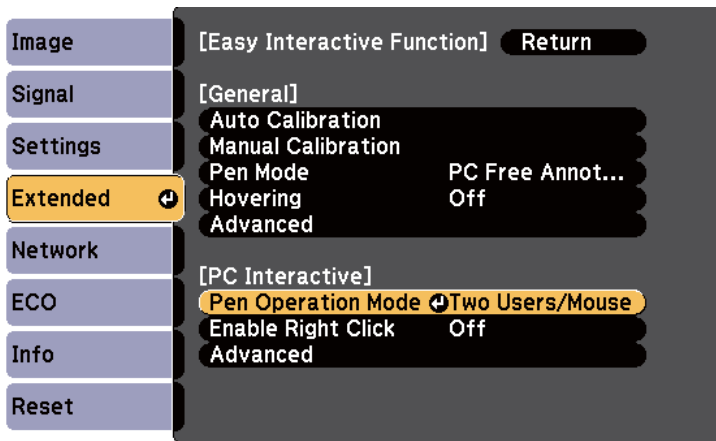

- 8** Select the **Easy Interactive Function** setting from the **Extended** menu, and then press the [Enter] button.
- 9** Set the **Pen Operation Mode** to **Two Users/Mouse** or **One User/Mouse**.



- 10** Press the [Enter] button, and then press the [Menu] button to exit the projector's menu system.
- 11** Make sure you have calibrated the first time you use your projector.
 - "Pen Calibration" p.68

- 12** Hold an interactive pen over the screen. The  icon is displayed.



- The  icon is displayed. Next time, it is displayed when you open the tool palette.
- If the  icon is displayed, set the setting to **On** in the **Extended** menu.

- 13** Select the  icon, and then press the [Enter] button.

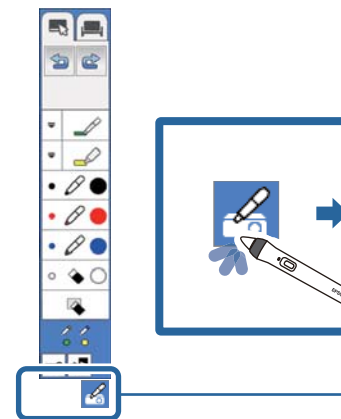

Interactive Feature Modes









You can also change to computer interactive mode by doing the following:

- Pressing the [Pen Mode] button on the remote control.
- Changing the **Pen Mode** setting on the projector's **Extended** menu to **PC Interactive**.
 - ☛ **Extended - Easy Interactive Function - Pen Mode** p.123

You can now operate the computer using the interactive pen.

- ☛ "Using the Interactive Pens" p.67
- ☛ "Interacting with the Screen" p.74
- ☛ "Using the Interactive Features over a Network" p.80



- You can also control the projector from the projected screen by using the projector control toolbar displayed on the screen. Tap the  or  icon if the projector control toolbar is not displayed.
- You can move the  and  toolbar tabs up and down, and the  or  toolbar tab right and left.
- You can also do the following in computer interactive mode:
 - Use the Tablet PC input panel in Windows 7 or Windows Vista.
 - Use Ink Tools for annotation in Microsoft Office applications.
- Using two interactive pens at the same time may cause interference in some application software. In that case, move any pen you are not using away from the projection screen.

Easy Interactive Driver System

To use computer interactive mode, you must install the Easy Interactive Driver on your computer. Check the software.

Operating Systems	Mac OS X Mac OS OS OS OS
CPU	PowerPC (Recommended)
Amount of Memory	512 MB or more
Hard Disk Space	100 MB or more
Display	Resolution: 1024 x 768 or higher and 16-bit color display

Installing Easy Interactive Driver

Install Easy Interactive Driver on your computer in computer interactive mode.



You may have already installed the Easy Interactive Driver. In that case, select the **Install** option, which also displays the *Interactive Tools Operation* details.

1

Turn on your computer.

Interactive Feature Modes

- 2** Insert the EPSON Projector Software for Easy Interactive Function CD into the computer.
You see the EPSON window.
- 3** Double-click the **Install Navi** icon in the EPSON window.
- 4** Select **Custom Install**.
- 5** Follow the on-screen instructions to install.
- 6** Restart your computer.

Using the Interactive Pens

Your projector comes with a blue pen and an orange pen, identified by the color on the end of the pen. You can use either pen, or both at the same time (one of each color).

Make sure the pen batteries are installed.

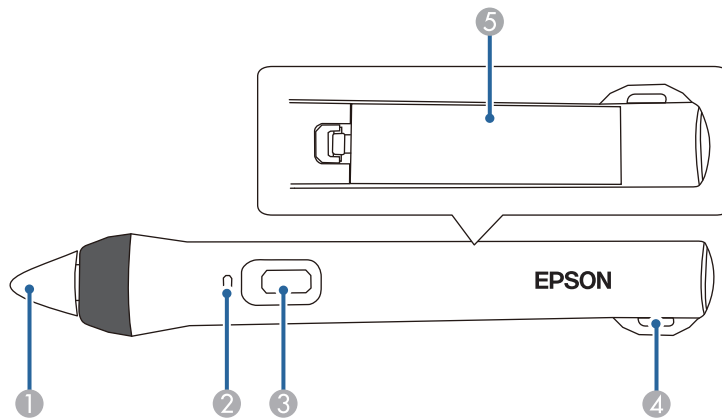

- ① Pen tip
- ② Battery light
- ③ Button
- ④ Attachment for optional strap or cord
- ⑤ Battery cover

To turn on the pen, tap the pen tip or press the button on the side.

When you are finished using the pen, leave the pen as it is far from the projection screen.

🖱️ "Easy Interactive Pen (EB-536Wi only)" [p.19](#)

Attention

- Do not use interactive pens with liquid. The pen may get wet. The pen is not waterproof.
- Keep the projector and projection screen clean. If the projector or projection screen is dirty, the interactive features may not work properly.



- The pens turn off automatically. To turn a pen back on, tap the pen tip or press the button on the side.
- For best performance, hold the pen as shown below. Do not hold the pen by the tip.

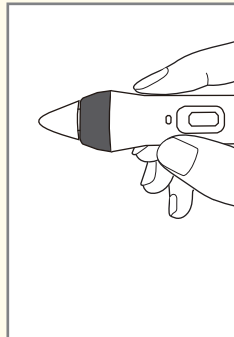

You can do the following using the pen:

Using the Interactive Pens

- Write or draw on the projection surface in annotation mode and whiteboard mode.

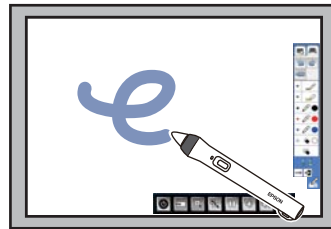
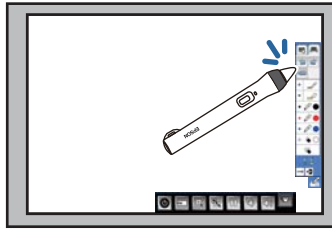

- To select a projected item, such as an icon, tap the projection surface with the pen tip.
 - To draw on the projected screen, tap the projection surface with the pen and drag it as necessary.
 - To move the projected pointer, hover over the surface without touching it.
- Use the pen as a mouse in computer interactive mode.



- To left-click, tap the board with the pen tip.
- To double-click, tap twice with the pen tip.
- To click and drag, tap and drag with the pen.
- To move the cursor, hover over the board without touching it.



- If you do not want to use the **Easy Interact Extended** menu.
 - **Extended - Easy I**
- To make a long press following settings in the projector's **Extended m**
 - Set the **Pen Operatio**
 - **User/Mouse.**
 - Set **Enable Right Cli**

Pen Calibration

Calibration coordinates the position of the cursor. You only need to calibrate

You can use **Auto Calibration**. **Calibration** is also available for failed.



- Move any pen you are using while calibrating the system.
- Calibrate the system again after positioning after doing
 - Performing Keystone
 - Adjusting the image
 - Changing the project
- The calibration results

Calibrating Automatically

You need to calibrate the first time you use the pens or a computer for

Using the Interactive Pens

When you hold down the [A/V Mute] button on the top of the projector for approximately three seconds, a pattern is projected and Auto Calibration begins.

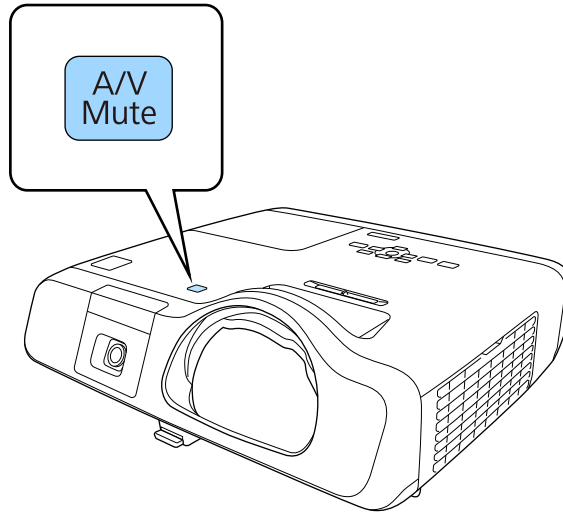

If Auto Calibration fails, an error message is displayed. Perform Manual Calibration.

The cursor location and pen position should match after calibration. If not, you may need to perform Manual Calibration.



- You can perform Auto Calibration from the Configuration menu. Perform operations as instructed in the message displayed.
 - ☛ **Extended - Easy Interactive Function - Auto Calibration** [p.123](#)
- You cannot perform Auto Calibration from the remote control's [A/V Mute] button. When you hold down the remote control's [A/V Mute] button, the **Projection** changes.
 - ☛ **Extended - Projection** [p.120](#)

Calibrating Manually

If the cursor location and pen position do not match, you can calibrate manually.

- 1** Press the [Menu] button, then the [Enter] button.

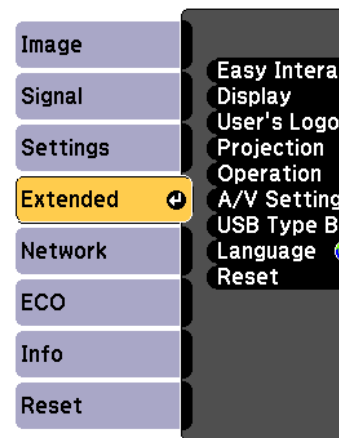

- 2** Select the **Easy Interactive Function** button.

Using the Interactive Pens

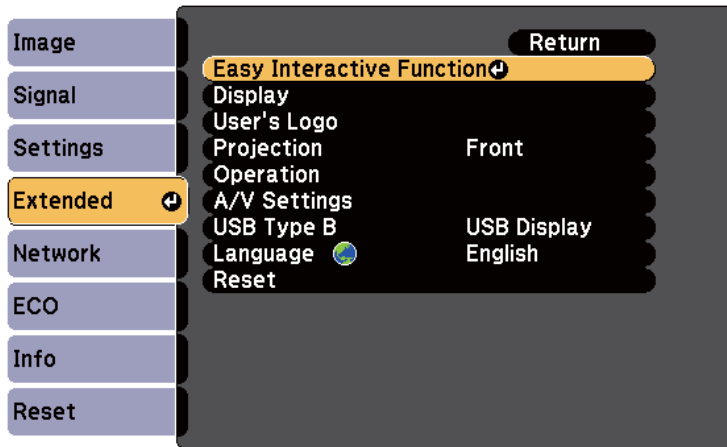

- 3** Select **Manual Calibration** and press the [Enter] button.

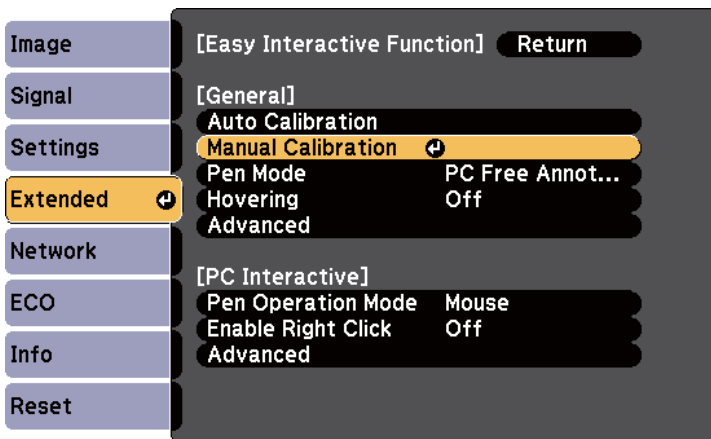

The following screen appears.

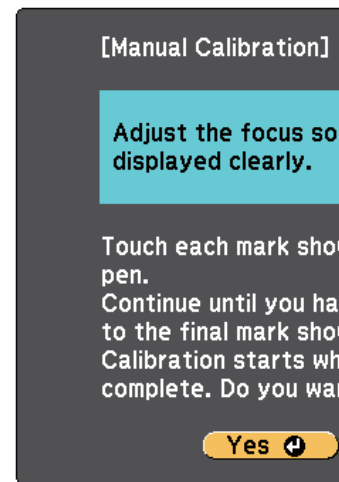

- 4** Adjust the focus if necessary.
- 5** Select **Yes** and press the [Enter] button. A flashing green circle appears on the projected image.
- 6** Touch the center of the flashing green circle with the pen. The circle disappears, and the calibration is complete.

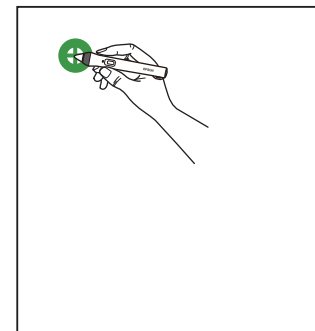

Using the Interactive Pens



For the most accurate calibration, make sure you touch the center of the circle.

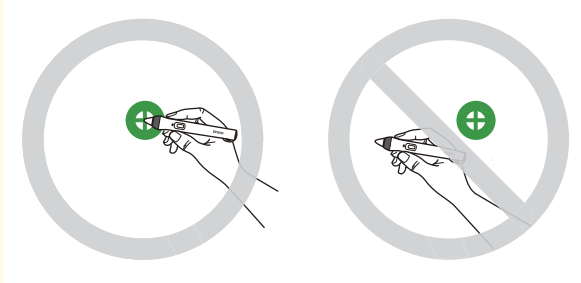

7

Touch the center of the next circle, then repeat. When you get to the bottom of the column, the next circle appears at the top of a new column.

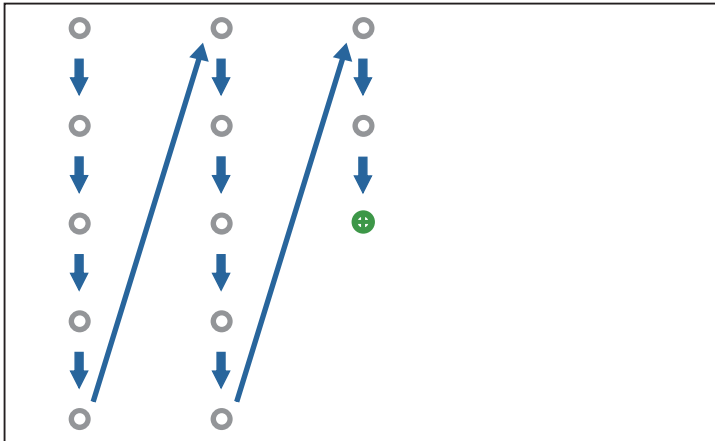

- Make sure you a and the interacti
- If you make a m control to go ba
- To cancel the ca button for 2 sec

8

Continue until all of the

Adjusting the Pen Op

The pen operation area is norma different computer or adjust the the pen position is incorrect wh projected screen (computer inter manually.



Manual adjustment is no source.

1

Switch to computer inter
☛ "Using Computer Inte

2

Press the [Menu] button,
the [Enter] button.

Using the Interactive Pens

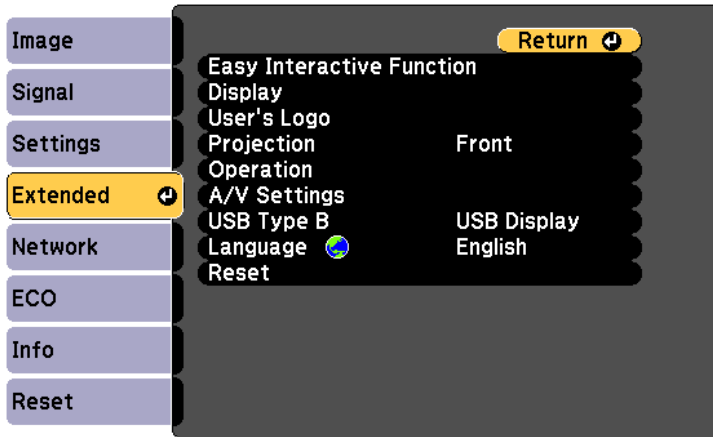

- 3** Select the **Easy Interactive Function** setting and press the [Enter] button.

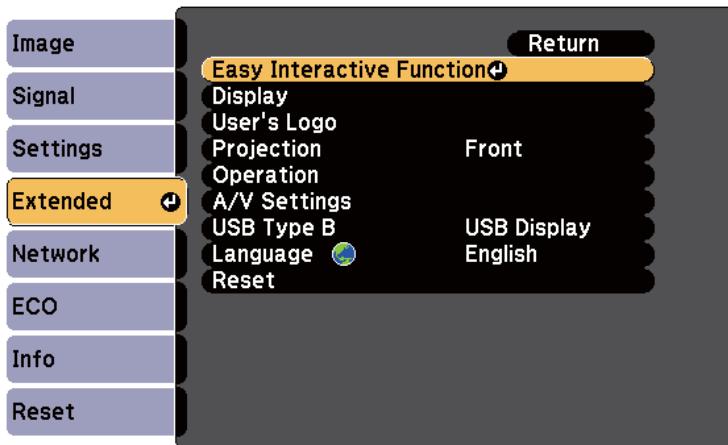

- 4** In the **PC Interactive** section, select **Advanced** and press the [Enter] button.

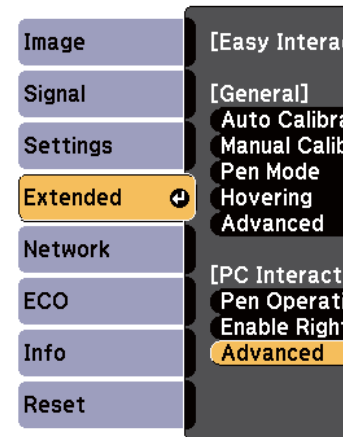

- 5** Select **Manual Adj. Pen**

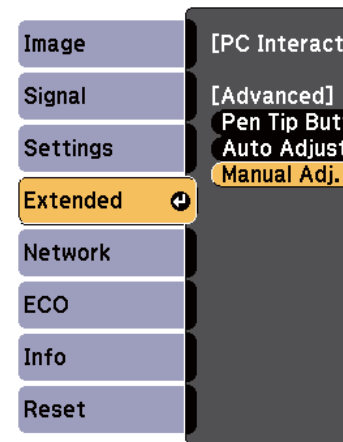

- 6** Select **Yes**, and then pre

Using the Interactive Pens

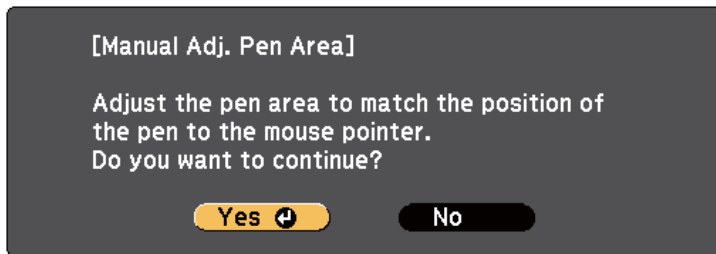

The mouse pointer moves towards the top left.

- 7** When the mouse pointer stops at the top left corner of the image, touch the tip of the pointer with the pen.

The mouse pointer moves towards the bottom right corner.

- 8** When the mouse pointer stops at the bottom right corner of the image, touch the tip of the pointer with the pen.

Interacting with the Screen

Follow these instructions to interact with the projected image or control the projector.

Switching the Interactive Mode

You can easily switch the interactive mode using the toolbar.

- To switch between computer interactive mode and annotation mode, select one of the following icons:
 - To change from annotation mode or whiteboard mode to computer interactive mode:

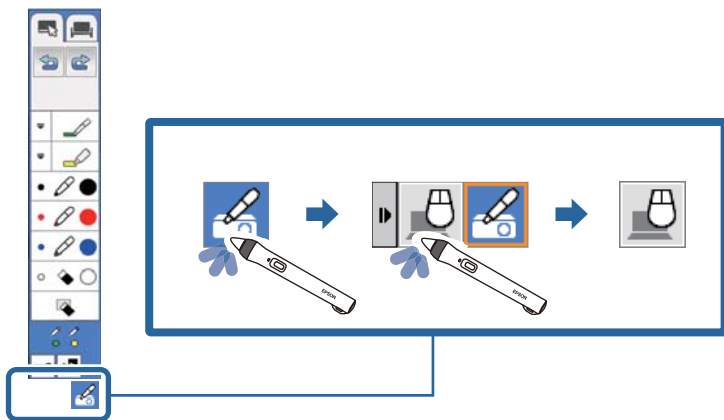

- To change from computer interactive mode to annotation mode or whiteboard mode:

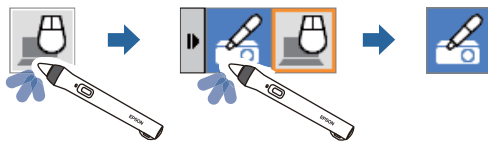

- To switch between annotation mode and whiteboard mode, select the following icon in the toolbar:

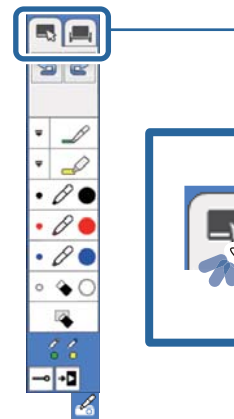

- You can also change the interactive mode by:
 - Pressing the [Pen Mode] button on the projector.
 - Switching to **PC Free Mode** setting on the projector.
 - **Extended - Easy Interactive Mode**
- You can switch to computer interactive mode from the computer screen.
- You cannot switch to computer interactive mode from the **Type B** setting in the projector.
- **Mouse/USB Display**.
- The computer screen is not in interactive mode from the projector.
- After changing to computer interactive mode, the annotation mode is retained.



Interacting with the Screen





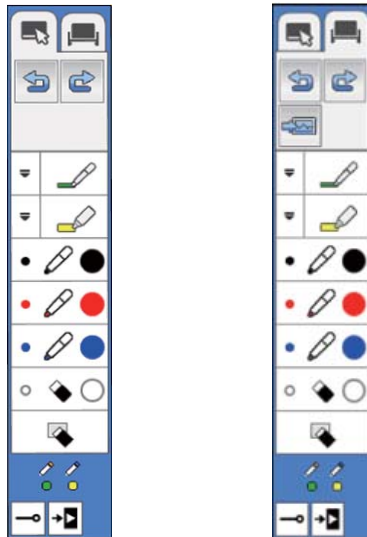





Annotation Mode and Whiteboard Mode Toolbars

The annotation mode toolbar or the whiteboard mode toolbar lets you draw and write on the projected screen. The toolbar also lets you easily switch to annotation or whiteboard mode.









In the following illustration, the annotation mode toolbar is shown on the left, and the whiteboard mode toolbar on the right:



	Switches to annotation mode.
	Switches to whiteboard mode.
	Undoes the last operation.

	Redoes the last un...
	Selects a white or (whiteboard mode) ☛ "Selecting Wh
	Writes or draws f Select the  ic ☛ "Selecting Line
	Writes or draws f pen. Select the  ic ☛ "Selecting Line
	Changes to a black thick lines, and cli
	Changes to a red thick lines, and cli
	Changes to a blue thick lines, and cli
	Switches to an era wider areas, and c areas.
	Clears all drawing

Interacting with the Screen

	<p>Displays which tool you are using with your pen  .</p> <p> : Using pen tools. The color of the icon indicates the color of the pen.</p> <p> : Using eraser tools.</p>
	<p>Hides or shows the toolbar while drawing.</p> <p> : The toolbar is hidden while drawing.</p> <p> : The toolbar is always displayed.</p>
	<p>Closes the toolbar.</p>

Selecting Line Width and Color

You can select the color and line width for both the custom Pen and the Highlighter tools.



- 1 Select the  icon next to the custom Pen or Highlighter annotation tool.

A box like the following appears.

- 2 Select the line width and color for the Pen or Highlighter tools.



- As you hover over the palette, the settings are displayed at the bottom.
- You can change the settings in the **Palette** setting in the **Extended - Color** settings.

- 3 Select the  or  to draw on the projection screen.



When multiple people draw on the projection screen with different pens, you can select different colors.

Interacting with the Screen

Selecting Whiteboard Templates

In whiteboard mode, you can change the background color, and insert horizontal lines or a background template.

- 1 In whiteboard mode, select the  icon.

A box like the following appears:

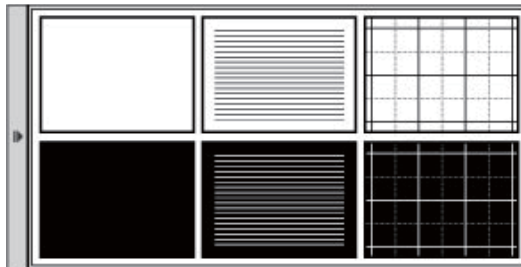









- 2 Select one of the template patterns.

Projector Control Toolbar

The projector control toolbar lets you control the projector from the projected screen just as you would using the remote control.

If your network device is connected to the projector using EasyMP Multi PC Projection, you can also use the toolbar to select the network device from which you want to project.



	Turns off the pro...
	Changes the imag To close the imag bottom of the list
	Zooms into and o icons in the displ <ul style="list-style-type: none">• The image can b the original ima• You can expand or - icon. To close the scale list.
	Turns off picture Tap the projected ☛ "Hiding the I p.90
	Pauses video actio ☛ "Freezing the
	Decreases the volu ☛ "Adjusting the
	Increases the volu ☛ "Adjusting the
	Closes the project

Interacting with the Screen

Selecting Network Device Display from the Projector Control Toolbar

If you have connected devices to the projector via a network, you can select to project an image from those devices using the projector control toolbar. You can select the image source from computers that are running EasyMP Multi PC Projection, and smartphones or tablets that are running Epson iProjection. You can change the projected screen by selecting from among up to 50 devices.



You can select any connected network device for projection, even if the user connected using the EasyMP Multi PC Projection software with the moderator feature enabled. See the *EasyMP Multi PC Projection Operation Guide* for details about the moderator feature.

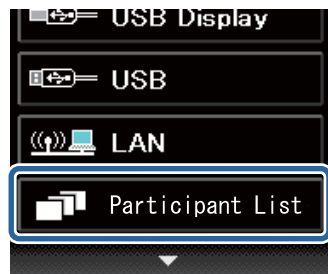

 [EasyMP Multi PC Projection Operation Guide](#)

- 1 Select the  icon on the projector control toolbar, and then select **Participant List** from the image source list.

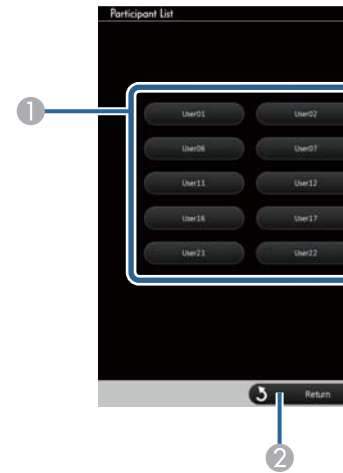

- 2 Select the user name for the device you want to project from.



- 1 Displays the user names for network devices. The  icon is shown next to each device.
- 2 Closes the user selection screen.
- 3 Refreshes the user list. When an additional user connects, press the  button to update the user list.

Interacting with the Screen



- When a selected device is disconnected from the projector, the selected user's screen is not displayed, and the user's list is automatically updated.
- While the user selection screen is displayed, you cannot do the following:
 - Select a different image source
 - Use other interactive features
 - Control the projector from the projector control toolbar
 - Connect to multiple projectors
 - Hear sound from the projector (it is turned off temporarily)
 - Change the settings using the projector's Configuration menu
 - Project an image using EasyMP Multi PC Projection or Epson iProjection

You see the selected user's screen image.

When you change the user, repeat these steps.



- You cannot access the user selection screen when connecting to multiple projectors by using EasyMP Multi PC Projection and projecting the same image (mirroring).
- If the interactive features do not work, you can return to the previous screen by pressing the [Esc] button on the remote control or the control panel.

Using the Interactive Features over a Network

You can use your projector in computer interactive mode over a network.

If you want to annotate when using computer interactive mode over a network, you need to use Easy Interactive Tools (or another annotation program). Easy Interactive Tools allows you to use various drawing tools, treat the drawing area as a page, and save your drawings as a file for a later use. You can install Easy Interactive Tools from the EPSON Projector Software for Easy Interactive Function CD. You can also download the software from the Epson website.

- Use one of the following software applications to setup your projector on a computer network and use computer interactive mode over the network:
 - EasyMP Network Projection version 2.85 or later (for Windows) or 2.83 or later (for OS X)
See the *EasyMP Network Projection Operation Guide* for instructions.
[EasyMP Network Projection Operation Guide](#)
 - Quick Wireless version 1.32 or later (Windows only)
See the instructions included with the optional Quick Wireless Connection USB Key.
- With either application, select **Use Interactive Pen** on the **General settings** tab and **Transfer layered window** on the **Adjust performance** tab.



- You can only use one
- The response may be s
- When using computer i
change the **Pen Mode** s
projector's **Extended m**
- You cannot change the
projector's **Extended m**
- You can connect up to
Network Projection. W
computer interactive m
performed on one proj
- To use annotation mode
on the **General setting**
Adjust performance ta
Wireless Connection, an

Precautions When Connecting to a Different Subnet

Follow these precautions when connecting to a different subnet using EasyMP Network Projection.

- Search for the projector on the network using the IP address. You cannot search for the projector by name.
- Make sure that you get an echo reply when sending an echo request. If you are using a firewall or Internet Control Message Protocol (ICMP) blocking router, you can connect to the projector but cannot get the echo reply back.

Using the Interactive Features over a Network

- Make sure the following ports are opened.

Port	Protocol	Usage	Communication
3620	TCP/UDP	For connection and control	Duplex
3621	TCP	For transferring images	Duplex
3629	TCP	For controlling projector	Duplex

- Make sure that the MAC address filtering and application filtering options are disabled on the router.
- Make sure that Network Address Translation (NAT) technology is not used in your network environment. With Internet VPN and IP-VPN, you can connect to the network projector remotely when you meet the above requirements.
- When bandwidth management is applied for communications between locations, and EasyMP Network Projection goes over the controlled bandwidth, you may not be able to connect to the projector at remote locations.



Epson does not guarantee the connection to the projector on a different subnet using EasyMP Network Projection even if you meet the above requirements. When considering the implementation, be sure to test the connection in your network environment.

Windows Pen Input and Ink Tools

If you are using Windows 8.1, Windows 8, Windows 7, or Windows Vista, you can use the pen input and Ink tools to add handwritten input and annotations to your work.

You can also use the pen input and Ink features over a network when you set the interactive features to be available on your network.

Enabling Windows Pen Input and Ink Features

If you want to use the pen input and Ink features in Windows 8.1, Windows 8, Windows 7, or Windows Vista, you need to adjust the pen settings in the projector's **Extended** menu.

- 1 Press the [Menu] button, select the **Extended** menu, and press the [Enter] button.

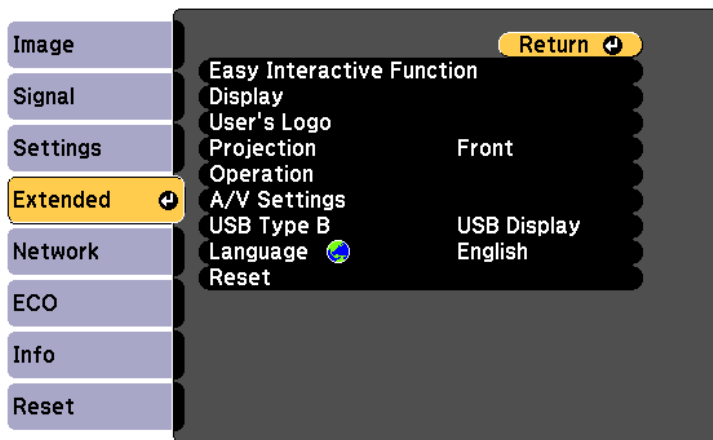

- 2 Select the **Easy Interactive Function** setting and press the [Enter] button.

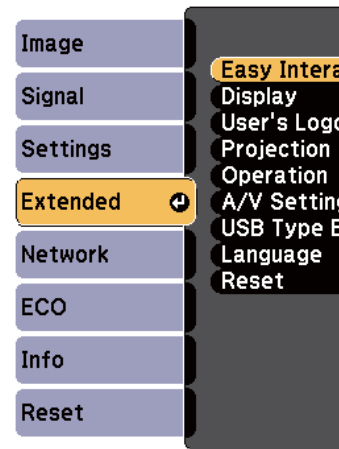

- 3 Select the **Pen Operation** button.

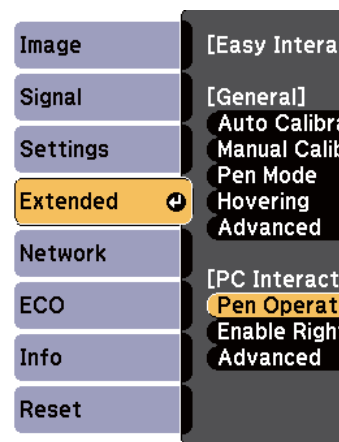

- 4 Select **One User/Pen** and

Windows Pen Input and Ink Tools

For more information about the

Using Windows Pen Input and Ink Features

If you are using Windows 8.1, Windows 8, Windows 7, or Windows Vista, you can add handwritten input and convert it to text.

If you have Microsoft Office 2007 or later, you can also use the Ink function to add handwritten notes to a Word document, Excel spreadsheet, or PowerPoint presentation.



Option names for the annotation functions may vary depending on your version of Microsoft Office.

- To open the Touch Keyboard in Windows 8, right-click or tap and hold on the Taskbar, then select **Toolbars > Touch Keyboard**. Select the keyboard icon on the screen, then select the pen icon.
- To open the Tablet PC input panel in Windows 7 or Windows Vista, select  > **All Programs > Accessories > Tablet PC > Tablet PC Input Panel**.

You can write in the box using the pen, then select from a variety of options to edit and convert the text.

- To add Ink annotations in Microsoft Office applications, select the **Review** menu, then select **Start Inking**.



In Microsoft Word or Excel, select the **Insert** tab and then click on **Start Inking**.

- To annotate your PowerPoint slides in Slideshow mode, press the button on the side of the pen, and then select **Pointer Options > Pen** from the pop-up menu.



This method for annotating PowerPoint slides in Slideshow mode also works with Windows XP Tablet PC Edition.

Useful Functions

This chapter explains useful tips for giving presentations, and the Security functions.

Projection Functions

Projecting Images Stored on a USB Storage Device (PC Free)

By connecting a USB storage device such as a USB memory or a USB hard disk to the projector, you can project the files stored on the device without using a computer. This function is called PC Free.



- You may not be able to use USB storage devices that incorporate security functions.
- You cannot correct keystone distortion while projecting in PC Free, even if you press the [↵] and [↶] buttons on the control panel.

Specifications for Files that Can Be Projected Using PC Free

Type	File Type (Extension)	Notes
Image	.jpg	The following cannot be projected. - CMYK color mode format - Progressive format - Images with a resolution greater than 8192 x 8192 Due to the characteristics of JPEG files, images may not be projected clearly if the compression ratio is too high.
	.bmp	Cannot project images with a resolution greater than 1280 x 800.
	.gif	<ul style="list-style-type: none"> • Cannot project images with a resolution greater than 1280 x 800. • Cannot project animated GIFs.
	.png	Cannot project images with a resolution greater than 1280 x 800.

Type	File Type (Extension)	Notes
	.avi (Motion JPEG)	<ul style="list-style-type: none"> • C • th • Y • li • S • C



- When connecting and using the projector, you connect the AC adapter.
- The projector does not project files if the media has been formatted in FAT32.
- Format the media in FAT32.

PC Free Examples

Projecting Images Stored on USB Storage Device



☛ "Projecting the Selected Image File"

☛ "Projecting Image Files in a Folder"

Projection Functions

PC Free Operating Methods

Although the following steps are explained based on the remote control, you can perform the same operations from the control panel.





Starting PC Free

1 Change the source to USB.
☛ "Switching to the Target Image Using the Remote Control" p.44

2 Connect the USB storage device to the projector.
☛ "Connecting USB Devices" p.30

PC Free starts and the file list screen is displayed.

- The following files are displayed as thumbnails (file contents are displayed as small images).
 - JPEG files
 - AVI files (displays the image at the start of the movie)
- Other files or folders are displayed as icons as shown in the following table.

Icon	File	Icon	File
	JPEG files*		BMP files
	GIF files		PNG files
	AVI (Motion JPEG) files*		

* When it cannot be displayed as a thumbnail, it is displayed as an icon.



- You can also insert a memory card to connect the reader to the available USB card reader on the projector.
- The projector can recognize the following screen: [▲], [▼], [◀], and [▶] use, and then press the

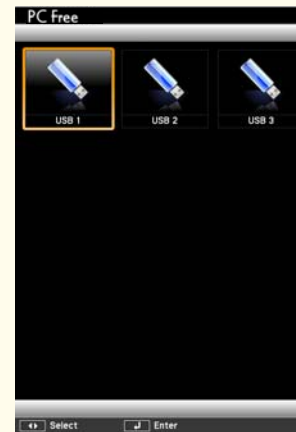

- To display the Select Drive at the top of the screen, press the button.

Projecting Images

- 1** Use the [▲], [▼], [◀], and [▶] folder you want to project.

Projection Functions



If not all of the files and folders are displayed on the current screen, press the [↵] button on the remote control, or position the cursor on **Next Page** at the bottom of the screen and press the [Enter] button.

To return to the previous screen, press the [⏪] button on the remote control, or position the cursor on **Previous Page** at the top of the screen and press the [Enter] button.

2 Press the [Enter] button.

The selected image is displayed.

When a folder is selected, the files in the selected folder are displayed. To return to the screen which was displayed before opening the folder, position the cursor on **Back to Top** and press the [Enter] button.

Rotating Images

You can rotate the played images in 90° increments. The rotating function is also available during PC Free.

1 Play images, or run PC Free.

2 While projecting, press the

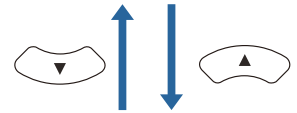

Stopping PC Free

To close PC Free, disconnect the projector. For devices such as a smartphone, disconnect the device and then remove it from the projector.

Projecting the Selected Images

Attention

Do not disconnect the USB storage device while projecting. The device may not operate correctly.

1 Start PC Free.

The file list screen is displayed.

☛ "Starting PC Free" p.8

Projection Functions

- 2 Press the [Up], [Down], [Left], and [Right] buttons to select the image file you want to project.



- 3 Press the [Enter] button.
The image is displayed.



Press the [Left] or [Right] buttons to move to the next or previous image file.

- 4 To finish projecting, perform one of the following operations.
- Projecting an image: Press the [Esc] button.
 - Projecting a movie: Press the [Esc] button to display the message screen, select **Exit**, and then press the [Enter] button.

When projection is finished,

Projecting Image Files in a Folder

You can project the image files in a folder. This function is called Slideshow. Use the [Enter] button to start the Slideshow.



To change files automatically, set the **Switching Time** from **Options** menu. The default setting is 3 seconds.

See "Image File Display Settings" on p.89

- 1 Start PC Free.
The file list screen is displayed.
See "Starting PC Free" on p.8
- 2 Use the [Up], [Down], [Left], and [Right] buttons to select the folder you want to project. Then press the [Enter] button.
- 3 Select **Slideshow** at the bottom of the screen and press the [Enter] button.
The Slideshow starts, and the image files are projected in sequence, one by one.
When the last file is projected, the screen returns to the file list screen automatically. If you set the **Switching Time** to 0, the screen returns to the file list screen immediately.



Projection Functions

screen, projection starts again from the beginning when it reaches the end.

☛ "Image File Display Settings and Slideshow Operation Settings" [p.89](#)

You can proceed to the next screen, return to the previous screen, or stop playback while projecting a Slideshow.



If **Screen Switching Time** on the Option screen is set to **No**, files do not change automatically when you select Play Slideshow. Press the  button, the [Enter] button, or the  button to continue to the next file.

You can use the following functions when projecting an image file with PC Free.

- Freeze
☛ "Freezing the Image (Freeze)" [p.91](#)
- A/V Mute
☛ "Hiding the Image and Sound Temporarily (A/V Mute)" [p.90](#)
- E-Zoom
☛ "Enlarging Part of the Image (E-Zoom)" [p.92](#)

Image File Display Settings and Slideshow Operation Settings

You can set the file display order and Slideshow operations on the Option screen.

- 1** Select **Option** at the bottom of the file list screen, and then press the [Enter] button.

- 2** When the following Option items.

Enable the settings by pressing the [Enter] button.

The following table shows

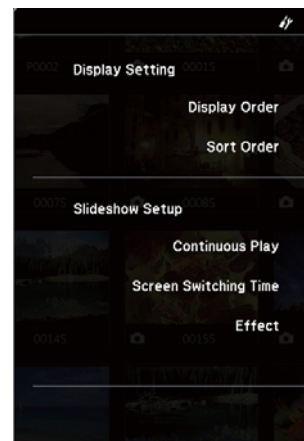

Display Order	You can s Order.
Sort Order	You can s Descend
Continuous Play	You can s
Screen Switching Time	You can s Slideshow seconds.
Effect	You can s

Projection Functions

3 Use the [▲], [▼], [◀], and [▶] buttons to position the cursor over **OK**, and then press the [Enter] button.

The settings are applied.

If you do not want to apply the settings, position the cursor on **Cancel**, and then press the [Enter] button.



- In the following situations:
 - When the projector is in the standby state
 - When the Configuration menu is displayed
 - When the projector's status is displayed
 - When performing Keypress
 - When Message Broadcast is performed
- The interactive function is not available when the projector is in the standby state or when the Configuration menu is displayed horizontally (EB-536Wi)

Flipping the Image Horizontally (Flip Horizontal)

You can temporarily flip the image horizontally and project.

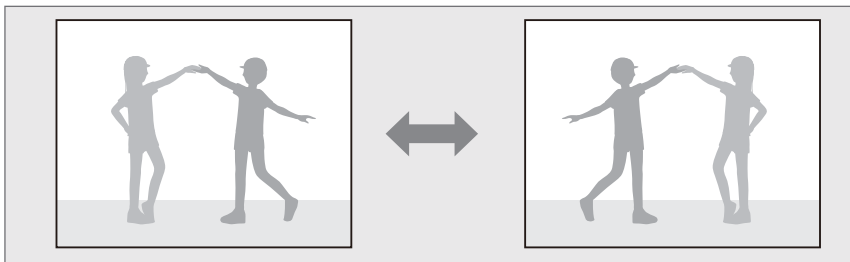

When **User Button** is set to **Flip Horizontal** from the Configuration menu, each time you press the [User] button, Flip Horizontal turns on or off.

☛ **Settings - User Button** p.119

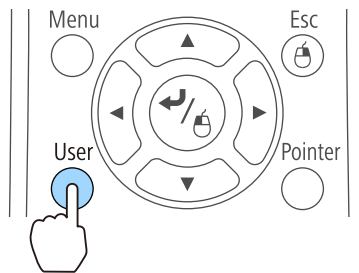

Hiding the Image and Mute

You can switch off the image or audio to draw the audience's attention on what you are saying. You can also display operations such as changing the slide.

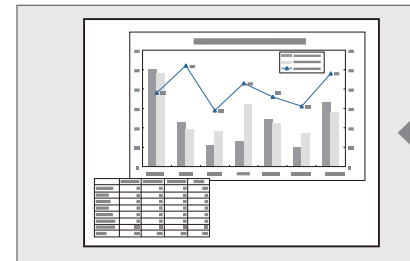

Each time you press the [A/V Mute] button, the image and audio are muted.

Remote control

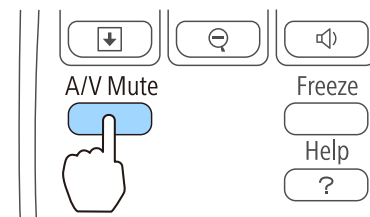

Projection Functions



- If you use this function when projecting moving images, the images and sound continue to be played back by the source, and you cannot return to the point where A/V Mute was activated.
- Microphone audio is still output even when A/V Mute is turned on.
- You can select the screen displayed when the [A/V Mute] button is pressed from the Configuration menu.
 - ☛ **Extended - Display - A/V Mute** p.120
- When A/V mute is enabled with the [A/V Mute] button, **A/V Mute Timer** activates and the power is automatically turned off after approximately 30 minutes. If you do not want to enable **A/V Mute Timer**, set **A/V Mute Timer** to **Off**.
 - ☛ **ECO - A/V Mute Timer** p.133
- The lamp is still lit during A/V Mute, so the lamp hours continue to accumulate.



- Audio does not stop.
- When projecting moving images, the images continue to be played back while the screen is frozen. The projection from the pointer disappears.
- If the [Freeze] button is pressed while the Help screen is displayed, the Help screen is closed.
- Freeze still works while the screen is frozen.

Freezing the Image (Freeze)

When Freeze is activated on moving images, the frozen image continues to project on the screen, so you can project a moving image one frame at a time like a still photo. Also, you can perform operations such as changing between files during presentations from a computer without projecting any images if the Freeze function is activated beforehand.

Each time you press the [Freeze] button, Freeze turns on or off.

Remote control

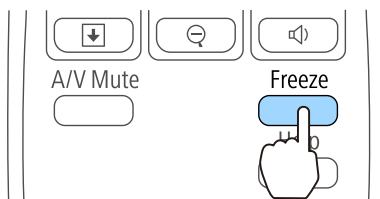

Pointer Function (Pointer)

This allows you to move a Pointer to the area you want to draw attention to on the screen.

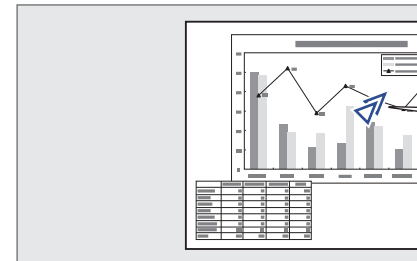

1 Display the Pointer.

Each time you press the [Pointer] button, the Pointer disappears.

Remote control

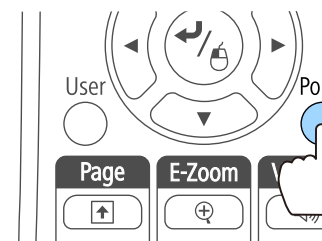

Projection Functions

- 2 Move the Pointer icon (↗).

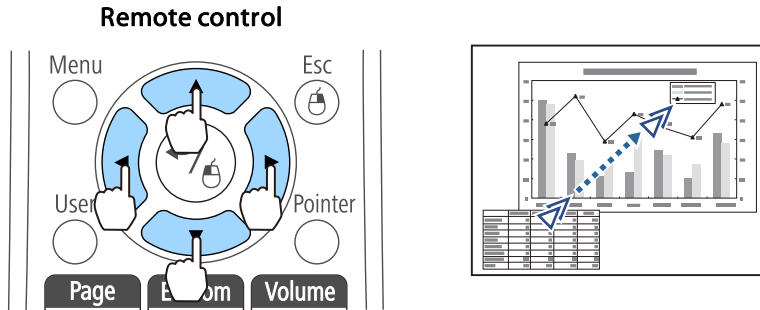

When any pair of adjacent [↖], [↘], [↙], or [↗] buttons are pressed at the same time, the pointer can be moved diagonally.



You can select the shape of the pointer icon from the Configuration menu.

🖱️ **Settings - Pointer Shape** [p.119](#)

Enlarging Part of the Image (E-Zoom)

This is useful when you want to expand images to see them in greater detail, such as graphs and tables.

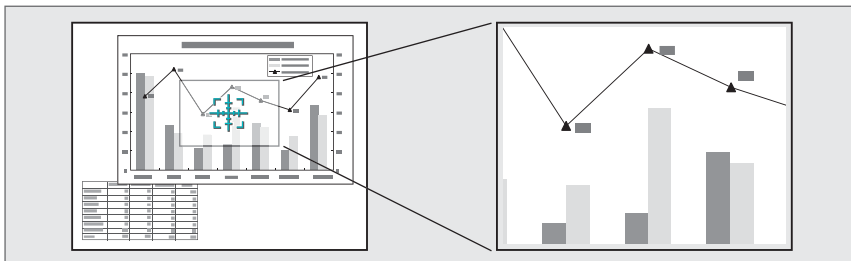

- 1 Start E-Zoom.

Press the [⊕] button to c

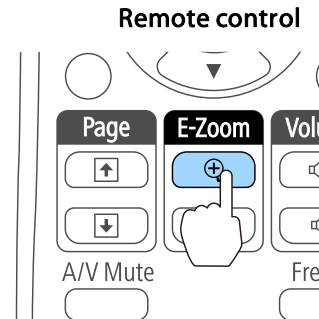

- 2 Move the Cross (⊕) to enlarge.

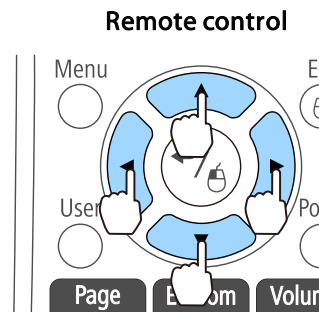

When any pair of adjacent buttons are pressed at the same time,

Projection Functions

3 Enlarge.

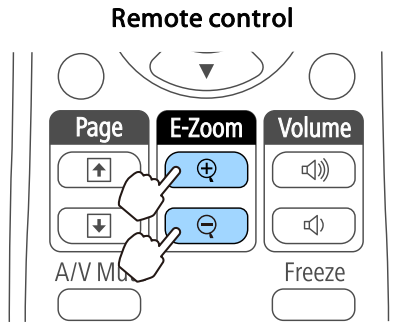

[+] button: Expands the area each time it is pressed. You can expand quickly by holding the button down.

[-] button: Reduces images that have been enlarged.

[Esc] button: Cancels E-Zoom.



- The enlargement ratio appears on the screen. The selected area can be enlarged to between 1 to 4 times in 25 incremental steps.
- During enlarged projection, press the [↶], [↷], [↵], and [↷] buttons to scroll the image.

Using the Remote Control to Operate the Mouse Pointer (Wireless Mouse)

You can control the computer's mouse pointer from the projector's remote control. This function is called Wireless Mouse.

The following operating systems are compatible with Wireless Mouse.

	Windows
OS	Windows 2000 Windows XP Windows Vista Windows 7 Windows 8 Windows 8.1

* It may not be possible to use versions of the operating system

Use the following procedure to

- 1** Set **USB Type B** to **Wireless Mouse** in the Configuration menu (EB-5).
 - ☛ **Extended - USB Type B**
- 2** Connect the projector to the computer using a commercially available USB cable.
 - ☛ "Connecting a Computer to the Projector"
- 3** Change the source to one of the following:
 - USB Display
 - Computer1
 - Computer2
 - HDMI
 - ☛ "Switching to the Target Source" p.44

Projection Functions

Once set, the mouse pointer can be controlled as follows.

Moving the mouse pointer

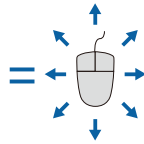
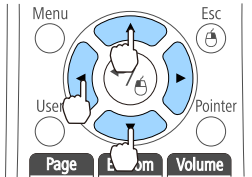

[][][][] buttons:

Moves the mouse pointer.

Mouse clicks

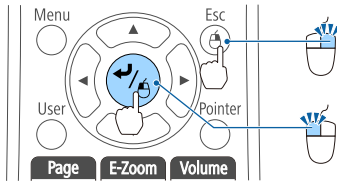

[Esc] button: Right click.

[Enter] button: Left click. Press quickly twice to double-click.

Drag and drop

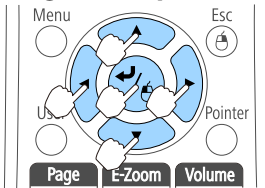

While holding down the [Enter] button, press the [], [], [, or [] button to drag.

Release the [Enter] button to drop at the desired location.

Page Up/Down

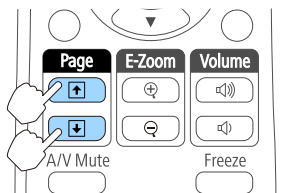

[] button: Moves to the previous page.

[] button: Moves to the next page.



- When any pair of adjacent buttons is pressed at the same time, the mouse pointer operation of the remote control is performed.
 - The Wireless Mouse function is available under the following conditions:
 - When **Extended** - USB D
 - **Wireless Mouse/USB D**
 - When displaying the
 - When operating function (such as adjusting the
- However, when using the or down function is available.

Projection Functions

Saving a User's Logo

You can save the image that is currently being projected as a User's Logo.

You can use the registered user's logo as a display when projection starts or no image signal is being input.

☛ **Extended - Display** p.120



- Once a User's Logo has been saved, the logo cannot be returned to the factory default.
- If the content of the Configuration menu is set from another projector using the batch setup function, the registered User's Logo is set for the other projectors. Do not register confidential information and so on as the User's Logo.
 - ☛ "Performing Batch Setup for Multiple Projectors" p.136

1 Project the image you want to save as the User's Logo, and then press the [Menu] button.

☛ "Using the Configuration Menu" p.113

Using the remote control

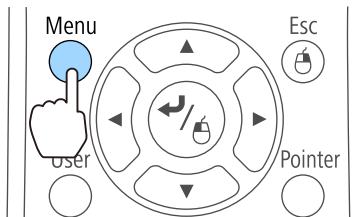

Using the control panel

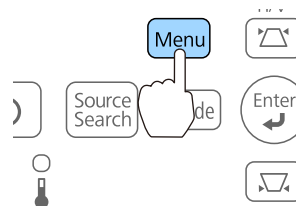

2 Select **User's Logo** from **Extended**.

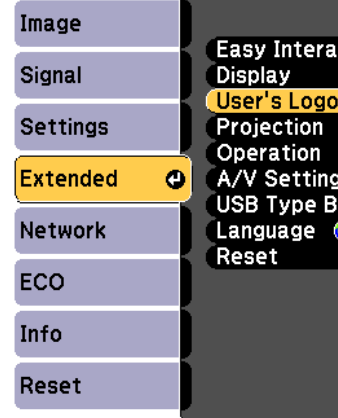

- When User's Logo is set to **On**, a message will be changed. You can change **Protection to Off**.
 - ☛ "Managing User's Logo"
- If User's Logo is set to **On**, Adjust Zoom are being performed.

3 When the message "Choose Yes" is displayed, select **Yes**.





When you press the [Menu] button on the control panel, the signal to match the

Projection Functions

- 4** Move the box to select the part of the image to use as the User's Logo.

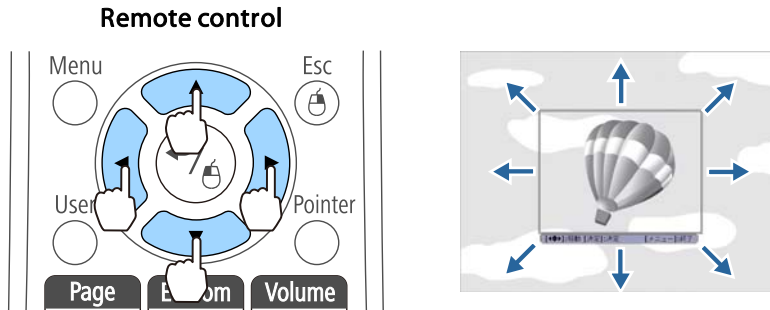
You can perform the same operations from the projector's control panel.



 You can save at 400 x 300 dots in size.

- 5** When you press the [Enter] button and the message "Select this image?" is displayed, select **Yes**.

- 6** Select the zoom factor for

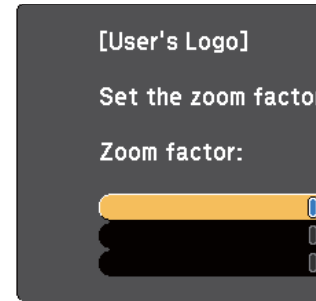

- 7** When the message "Save" is displayed, select **Yes**.

The image is saved. After "Completed." is displayed.

 When a User's Logo is erased.

Saving User Pattern

There are five types of patterns: lines and grid patterns.

 **Settings - Pattern - Pattern**

You can also save the image that is the User Pattern.

 When a User Pattern is

Projection Functions

- 1 Project the image you want to use as the User Pattern, and then press the [Menu] button.

☛ "Using the Configuration Menu" p.113

Using the remote control

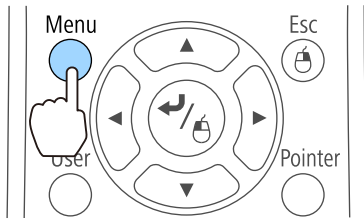

Using the control panel

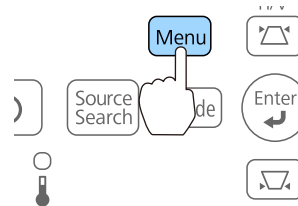

- 2 Select **Pattern** from **Settings**.

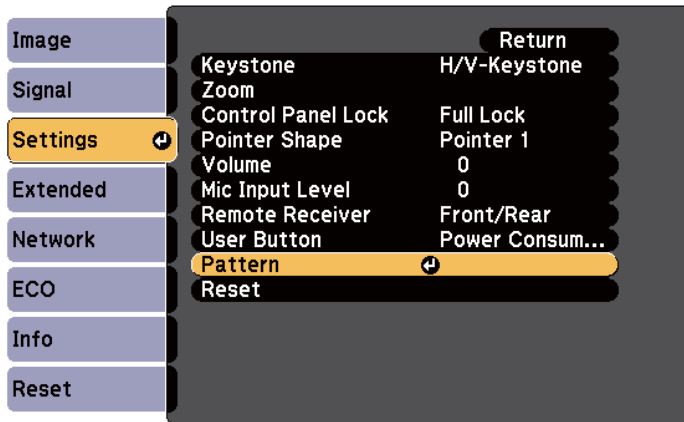

- 3 Select **User Pattern**.

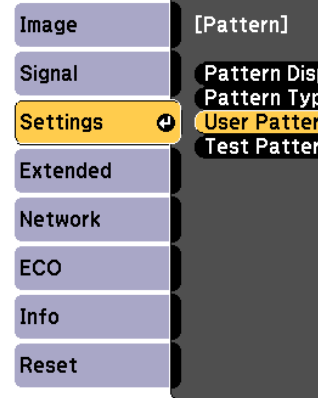

If **User Pattern** is selected, Adjust Zoom is performed. If the User Pattern setting is changed, Adjust Zoom is canceled.

- 4 When "Do you want to use the User Pattern?" is displayed, press the [Enter] button.

- 5 When you press the [Enter] button, the image is saved. After the image is saved, "The User Pattern setting is complete" is displayed.



Once a User Pattern is returned to the factory default, the User Pattern setting is canceled.

Security Functions

The projector has the following enhanced security functions.

- **Password Protection**

You can limit who can use the projector.

- **Control Panel Lock**

You can prevent people changing the settings on the projector without permission.

☛ "Restricting Operation (Control Panel Lock)" [p.100](#)

- **Anti-Theft Lock**

The projector is equipped with the following anti-theft security device.

☛ "Anti-Theft Lock" [p.101](#)

- **User's Logo Protection**

Even if someone tries to change the projector, it cannot be changed. When **On**, the following setting changes are made.

- Capturing a User's Logo

- Setting **Display Background Display**

- ☛ **Extended - Display**

- **Network Protection**

When **Network Protection** is **On**, **Network** is prohibited.

☛ "Network Menu" [p.124](#)

Managing Users (Password Protection)

When Password Protection is activated, people who do not know the password cannot use the projector to project images even if the projector power is on. Furthermore, the user's logo that is displayed when you turn on the projector cannot be changed. This acts as an anti-theft device as the projector cannot be used even if it is stolen. At the time of purchase, Password Protection is not activated.

Kinds of Password Protection

The following three kinds of Password Protection settings can be made according to how the projector is being used.

- **Power On Protection**

When **Power On Protection** is **On**, you need to enter a preset password after the projector is plugged in and turned on (this also applies to Direct Power On). When the correct password is entered, projection starts.

Setting Password Protection

Use the following procedure to set Password Protection.

1 During projection, hold the **Power** button for 3 seconds.

The Password Protection menu appears.

Remote control

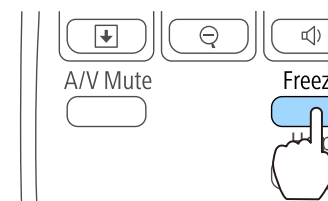

Security Functions



- If Password Protection is already activated, you must enter the password.
If the password is entered correctly, the Password Protection setting menu is displayed.
☛ "Entering the Password" p.99
- When the password is set, stick the supplied password protect sticker in a visible position on the projector as a further theft deterrent.

- 2** Select the type of Password Protection you want to set, and then press the [Enter] button.

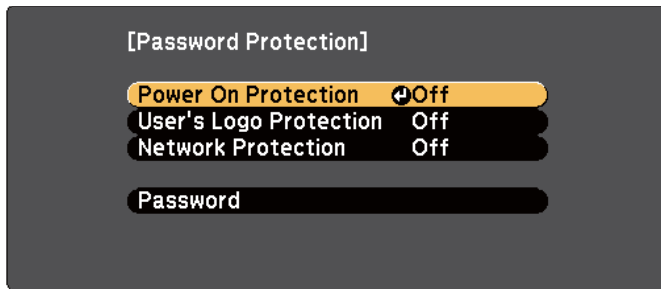

- 3** Select **On**, and then press the [Enter] button.
Press the [Esc] button, the screen displayed in step 2 is displayed again.

- 4** Set the password.
- (1) Select **Password**, and then press the [Enter] button.
 - (2) When the message "Change the password?" is displayed, select **Yes** and then press the [Enter] button. The default password is set to "0000". Change this to your own desired Password. If you select **No**, the screen displayed in step 2 is displayed again.
 - (3) While holding down the [Num] button, enter a four digit number using the numeric buttons. The number entered is displayed as "* * * *". When you enter the fourth digit, the confirmation screen is displayed.

- (4) Re-enter the password.
The message "Password" is displayed.
If you enter the password correctly, the message "Password" is displayed.
If you enter the password incorrectly, the message "Password" is displayed.
If you enter the password incorrectly, you to re-enter the password.

Entering the Password

When the password entry screen is displayed, use the remote control.

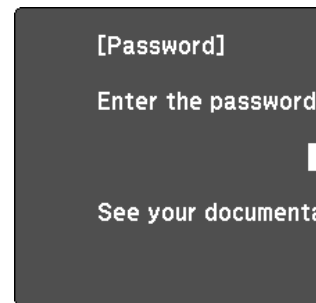

While holding down the [Num] button, enter a four digit number using the numeric buttons.



When you enter the correct password, the message "Password" is displayed.
When you enter the correct password, the message "Password" is displayed.
When you enter the correct password, the message "Password" is displayed.

Security Functions

Attention

- If an incorrect password is entered three times in succession, the message "The projector's operation will be locked." is displayed for approximately five minutes, and then the projector switches to standby mode. If this happens, disconnect the power plug from the electrical outlet and then reinsert it and turn the projector's power back on. The projector displays the password entry screen again so that you can enter the correct password.
- If you have forgotten the password, make a note of the "Request Code: xxxxx" number that appears on the screen and contact the nearest address provided in the Epson Projector Contact List.
 [Epson Projector Contact List](#)
- If you continue to repeat the above operation and input the wrong Password 30 times in succession, the following message is displayed and the projector does not accept any more Password entries. "The projector's operation will be locked. Contact Epson as described in your documentation."
 [Epson Projector Contact List](#)

Restricting Operation (Control Panel Lock)

Do one of the following to lock the operation buttons on the control panel.

- Full Lock
All of the buttons on the control panel are locked. You cannot perform any operations from the control panel, including turning the power on or off.
- Partial Lock
All of the buttons on the control panel, except for the [⏻] power button, are locked.

This is useful at events or shows when you want to deactivate all buttons during projection or at schools when you want to limit button operation. The projector can still be operated using the remote control.

- 1 Press the [Menu] button
 "Using the Configuration Menu"
Using the remote control

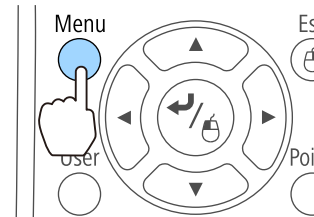

- 2 Select **Control Panel Lock**

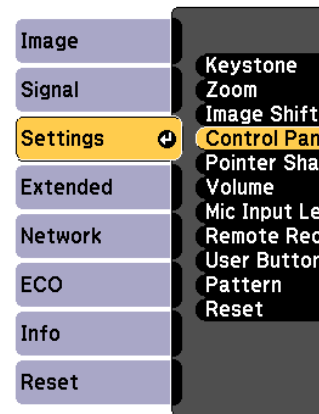

- 3 Select either **Full Lock** or **Partial Lock**

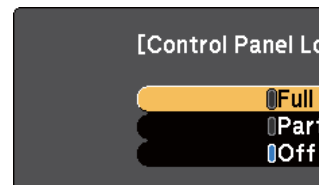

Security Functions

- 4** Select **Yes** when the confirmation message is displayed.
The control panel buttons are locked according to the setting you chose.



You can release the control panel lock by one of the following two methods.

- Select **Off** from **Control Panel Lock**.
 - **Settings - Control Panel Lock** [p.119](#)
- Press and hold down the [Enter] button on the control panel for about seven seconds, a message is displayed and the lock is released.

Anti-Theft Lock

The projector is equipped with devices.

- **Security slot**
The security slot is compatible with devices manufactured by Kensington. See the following for more details.
 - <http://www.kensington.com>
- **Security cable installation point**
A commercially available theft-prevention cable can be attached through the installation point. Do not pass drop-prevention wires through the projector on a wall or suspended ceiling.

Installing the Wire Lock

Pass an anti-theft wire lock through the installation point.
See the documentation supplied with the wire lock.

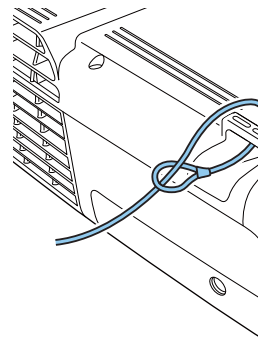

Monitoring and Controlling

About EasyMP Monitor

EasyMP Monitor lets you carry out operations such as checking the status of multiple Epson projectors that are connected to a network at a computer monitor, and controlling the projectors from the computer.

You can download EasyMP Monitor from the following Web site.

<http://www.epson.com>

The following provides descriptions of the monitoring and control functions that can be carried out using EasyMP Monitor.

- Registering projectors for monitoring and control
- Group registration for registered projectors
- Monitoring the status of registered projectors
- Controlling registered projectors
- Mail Notification settings
- Sending messages to registered projectors

Message Broadcasting

Message Broadcasting is plugin software for EasyMP Monitor. Message Broadcasting can be used to send a message (JPEG file) to project on all Epson projectors or specified projectors connected on the network.

The data can be sent manually, or sent automatically using Timer Settings of EasyMP Monitor.

Download the Message Broadcasting software from the following Web site.

<http://www.epson.com>

Changing Settings Using a Web Browser (Web Control)

By using a Web browser of a computer connected to the projector on a network, you can set the projector's functions and control the projector.

This function allows you to perform operations. In addition, since you can use the Web browser, the setup required for the setup is easier.

Use Microsoft Internet Explorer 8 or later for OS X.



If you set **Standby Mode** to **ECO**, you can use a Web browser to make settings when the projector is in standby mode.

☛ **ECO - Standby Mode**

Projector Setup

In a Web browser, you can set the projector's functions. The Configuration menu. The settings for each item are as follows. There are also items that can only be set with a Web browser.

Items in the Configuration menu that can only be set with a Web browser are as follows.

- Settings menu - Pointer Shape
 - Settings menu - Pattern (except for the Settings menu)
 - Settings menu - User Button
 - Extended menu - User's Logo
 - Extended menu - USB Type I
 - Extended menu - Easy Interac
 - Extended menu - Language
 - Reset menu - Reset All and F
- The settings for items on each menu are as follows. The settings for items on each menu are as follows. The settings for items on each menu are as follows.

☛ "Configuration Menu" p.112

Items that can Only Be Set with a Web browser are as follows.

- SNMP Community Name (up

Monitoring and Controlling

- Monitor Password (up to 16 single-byte alphanumeric characters)

Displaying the Web Control Screen

Use the following procedure to display the Web Control screen.

Make sure the computer and projector are connected to the network. Use Advanced when connecting via a Wireless LAN.



If your Web browser is set up to connect via a proxy server, the Web Control screen cannot be displayed. To display Web Control, you need to make settings so that a proxy server is not used for a connection.

- 1** Start a Web browser on the computer.
- 2** Enter the IP address of the projector in the address input box of the Web browser, and press the Enter key on the computer's keyboard.

The Web Control screen is displayed.

When **Web Control Password** is set from the Configuration menu, the password entry screen is displayed.

- 3** Enter the User ID and Password, and then press the Enter key on your computer's keyboard.

The User ID is "**EPSONWEB**".

The default password is "**admin**".

When the correct user ID and password are entered, the Web control screen is displayed.



- Enter the user ID and Password. You cannot change the user ID.
 - You can change the Password from the Configuration menu.
- 🖱️ Network - IP

Displaying the Web Remote screen

The Web Remote function allows you to perform operations with a Web browser.

- 1** Display the Web Control screen.
- 2** Click **Web Remote**.

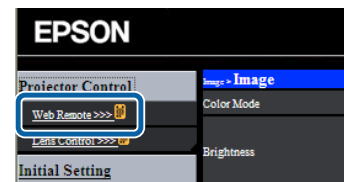

- 3** The Web Remote screen is displayed.

Monitoring and Controlling

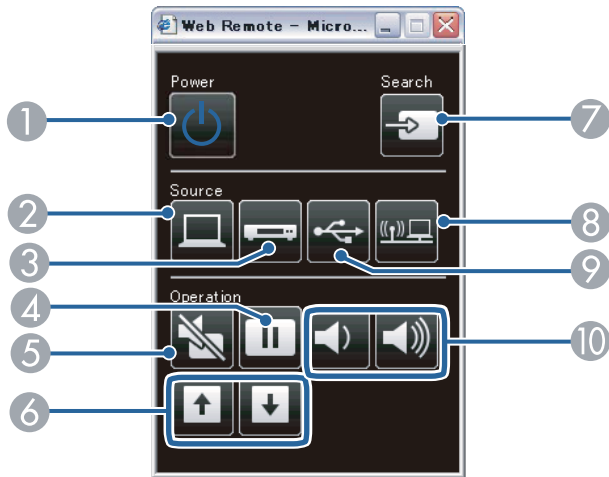

Name	Function
① [Power] button [⏻]	Turns the projector power on or off. ☛ "Turning On the Projector" p.41
② [Computer] button	Each time the button is pressed, it cycles through the following images: <ul style="list-style-type: none"> • Computer1 port • Computer2 port
③ [Video] button	Each time the button is pressed, it cycles through the images being input from the following sources. <ul style="list-style-type: none"> • S-Video port • Video port • HDMI port
④ [Freeze] button	Pauses or resumes image playback. ☛ "Freezing the Image (Freeze)" p.91
⑤ [A/V Mute] button	Turns the video and audio on or off. ☛ "Hiding the Image and Sound Temporarily (A/V Mute)" p.90

Name	Function
⑥ [Page] buttons [Up] [Down]	Changes the following signals: <ul style="list-style-type: none"> • When [Up] is pressed, the mouse cursor moves up. • When [Down] is pressed, the mouse cursor moves down.
⑦ [Source Search] button	Switches the source signals and displays the source. ☛ "Auto Search" p.41
⑧ [LAN] button	Switches the LAN control. ☛ "Switching the LAN Control" p.41
⑨ [USB] button	Each time the button is pressed, it cycles through the following images: <ul style="list-style-type: none"> • USB D • Images
⑩ [Volume] button [⏮][⏭]	[⏮] Decreases the volume. [⏭] Increases the volume. ☛ "Adjusting the Volume" p.91

Using the Mail Notification Problems

When you set Mail Notification, you can specify email addresses when a problem occurs.

Monitoring and Controlling

will enable the operator to be notified of problems with projectors even at locations away from the projectors.

☛ Network - Mail - Mail Notification [p.131](#)



- Up to three notification destinations (addresses) can be registered, and notification messages can be sent to all three destinations at once.
- If a projector develops a critical problem and suddenly stops working, it may not be able to send a message notifying an operator of the problem.
- Controlling is possible if **Standby Mode** is set to **Communication On**, even if the projector is in standby state (when the power is off).

☛ ECO - Standby Mode [p.133](#)

Reading Error Notification Mail

When the Mail Notification function is set to On and a problem or warning occurs in the projector, the following email will be sent.

Sender: Email Address 1

Email title: EPSON Projector

Line 1: The projector name where the problem has occurred

Line 2: The IP address set for the projector where the problem has occurred

Line 3 and on: Details of the problem

The details of the problem are listed line by line. The main message contents are listed below.

- Internal error
- Fan related error
- Sensor error

- Lamp timer failure
- Lamp out
- Internal temperature error
- High-speed cooling in progress
- Lamp replacement notification
- No-signal
No Signal is input to the projector that the power for the signal
- Auto Iris Error
- Power Err. (Ballast)

See the following to deal with p

☛ "Reading the Indicators" [p.14](#)

Management Using SNMP

By setting **SNMP** to **On** in the C are sent to the specified computer will enable the operator to be no locations away from the projector

☛ Network - Others - SNMP

Monitoring and Controlling



- SNMP should be managed by a network administrator or someone who is familiar with the network.
- To use the SNMP function to monitor the projector, you need to install the SNMP manager program on your computer.
- The SNMP Agent for this projector complies with version 1 (SNMPv1).
- The managing function using SNMP cannot be used via wireless LAN in Quick mode.
- Up to two destination IP addresses can be saved.

ESC/VP21 Commands

You can control the projector from an external device using ESC/VP21.

Command list

When the power ON command is transmitted to the projector, the power turns on and it enters warm-up mode. When the projector's power has turned on, a colon ":" (3Ah) is returned.

When a command is input, the projector executes the command and returns a ":", and then accepts the next command.

If the command being processed terminates abnormally, an error message is output and a ":" is returned.

The main contents are listed below.

Item		Command	
Power ON/OFF	On	PWR ON	
	Off	PWR OFF	
Signal selection	Computer1	Auto	SOURCE 1F
		RGB	SOURCE 11
		Component	SOURCE 14

Item	
	Computer2
	HDMI
	Video
	S-Video
	USB Display
	USB
A/V Mute ON/OFF	LAN
	On
	Off

Add a Carriage Return (CR) code to transmit.

For more details, contact your local Epson Projector Contact Center.

 [Epson Projector Contact List](#)

Cable Layouts

Serial Connection

- Connector shape: D-Sub 9-pin

Monitoring and Controlling

- Projector input port name: RS-232C

<At the projector>

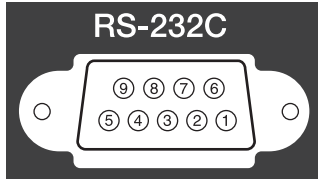

<At the computer>

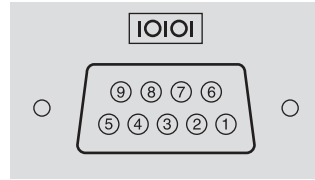

<At the projector>

(PC serial cable)

<At the computer>

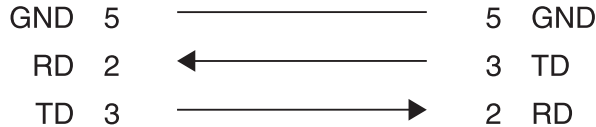

Signal Name	Function
GND	Signal wire ground
TD	Transmit data
RD	Receive data

Communications protocol

- Default baud rate setting: 9600 bps
- Data length: 8 bit
- Parity: None
- Stop-bit: 1 bit
- Flow control: None

About PJLink

PJLink Class1 was established by Information System Industries Association to standardize projector control protocols.

The projector complies with the JBMIA.

You need to make network settings following for more information

☛ "Network Menu" p.124

It complies with all commands established by PJLink Class1, and agreement adaptability verification.

URL:<http://pjlink.jbmia.or.jp/english/>

- **Non-compatible commands**

	Function
Mute settings	Image mute
	Audio mute

- **Input names defined by PJLink**

Source
Computer1
Computer2
Video
S-Video
HDMI
USB

Monitoring and Controlling

Source	PJLink Command
LAN	INPT 52
USB Display	INPT 53

- Manufacturer name displayed for "Manufacture name information query"
EPSON
- Model name displayed for "Product name information query"
EPSON 536
EPSON 535
EPSON 525
EPSON 530
EPSON 520

About Crestron RoomView®

Crestron RoomView® is an integrated control system provided by Crestron®. It can be used to monitor and control multiple devices connected on a network.

The projector supports the control protocol, and can therefore be used in a system built with Crestron RoomView®.

Visit the Crestron® Web site for details on Crestron RoomView®. (Only English-language displays are supported.)

<http://www.crestron.com>

The following provides an overview of Crestron RoomView®.

- **Remote operation using a Web browser**
You can operate a projector from your computer just like using a remote control.

- **Monitoring and control with**
You can use Crestron RoomView® Server Edition provided by Crestron to communicate with the help of the following Web site for details: <http://www.crestron.com/getroomview>

This manual describes how to operate the projector from a Web browser.



- You can only enter single characters.
- The following functions are available in Crestron RoomView®.
 - ☛ "Changing Settings" p.102
 - Message Broadcasting (p.102)
- Controlling is possible in Standby Mode (ECO - Standby Mode), even if the projector is powered off).
 - ☛ ECO - Standby Mode (p.102)

Operating a Projector from Your Computer

Displaying the Operation Window

Check the following before carrying out the operation.

- Make sure the computer and projector are connected in the same network. When communicating with a projector in the same network connection mode.
 - ☛ "Wireless LAN Menu" p.12
- Set **Crestron RoomView** to **On**.
 - ☛ **Network - Others - Crestron RoomView** (p.12)

Monitoring and Controlling

- 1 Start a Web browser on the computer.
- 2 Enter the IP address of the projector in the address field of the Web browser, and press the Enter key on the keyboard.
The operation window is displayed.

Using the Operation Window

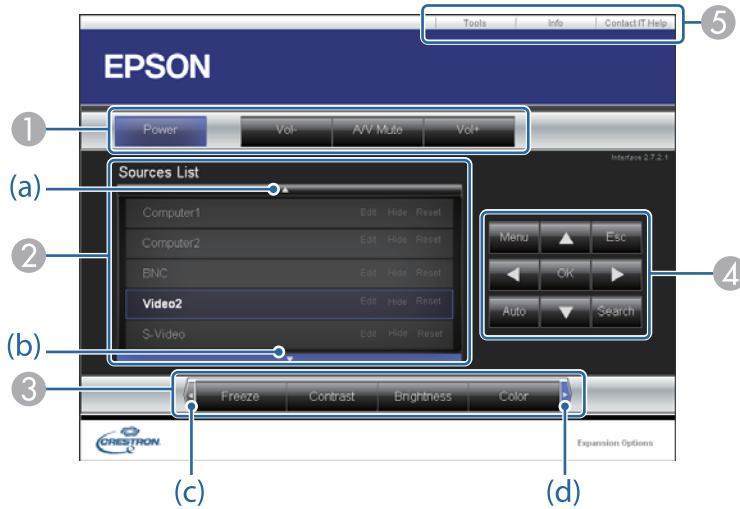

- 1 You can perform the following operations when you click the buttons.

Button	Function
Power	Turns the projector power on or off.
Vol-/Vol+	Adjusts the volume.

Button	
A/V Mute	Turns ☞ "H Mute)

- 2 Switch to the image from the sele
are not shown on the screen, click
signal input source is displayed i
You can change the source name
- 3 You can perform the following op
buttons that are not shown on th

Button	
Freeze	Image ☞ "Fr
Contrast	You ca the im
Brightness	You ca
Color	You ca
Sharpness	You ca
Zoom	Click t changi reduc Click t positio ☞ "E

- 4 The [▲], [▼], [◀], and [▶] bu
[☺], [◁], and [▷] buttons on
following operations when you c

Monitoring and Controlling

Button	Function
OK	Performs the same operation as the [Enter] button on the remote control. ☛ "Remote Control" p.16
Menu	Displays and closes the Configuration menu.
Auto	If clicked while projecting analog RGB signals from Computer1 port or Computer2 port, automatically optimizes the image by adjusting the Tracking, Sync., and Position.
Search	Switches to the image from the input port where video signals are being input. ☛ "Automatically Detect Input Signals and Change the Projected Image (Source Search)" p.43
Esc	Performs the same operation as the [Esc] button on the remote control. ☛ "Remote Control" p.16

5 You can perform the following operations when you click the tabs.

Tab	Function
Contact IT Help	Displays the Help Desk window. Used to send messages to, and receive messages from, the administrator using Crestron RoomView® Express.
Info	Displays information on the projector that is currently connected.
Tools	Changes settings in the projector that is currently connected. See the next section.

Using the Tools Window

The following window is displayed when you click the **Tools** tab on the operation window. You can use this window to change settings in the projector that is currently connected.

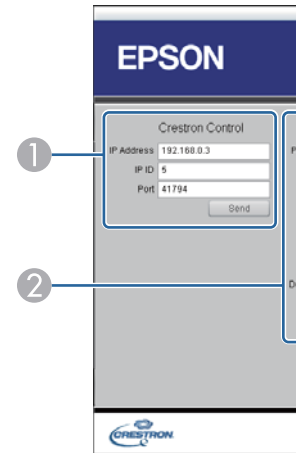

- 1 **Crestron Control**
Make settings for Crestron® control.
- 2 **Projector**
The following items can be set.

Item	
Projector Name	Enter a current network name in alphanumeric characters.
Location	Enter a location name that is up to 32 characters long.
Assigned To	Enter a name that contains alphanumeric characters and spaces.

Monitoring and Controlling

Item	Function
DHCP	Select the Enabled check box to use DHCP. You cannot enter an IP address if DHCP is enabled.
IP Address	Enter the IP address to assign to the currently connected projector.
Subnet Mask	Enter a subnet mask for the currently connected projector.
Default Gateway	Enter the gateway address for the currently connected projector.
Send	Click this button to confirm the changes made to the Projector .

Item	
New Password	Enter t open t alphan
Confirm	Enter t Passw display
Send	Click t User P

3 Admin Password

Select the **Enabled** check box to require a password to open the Tools window. The following items can be set.

Item	Function
New Password	Enter the new password when changing the password to open the Tools window. (The name can contain up to 26 single-byte alphanumeric characters.)
Confirm	Enter the same password as you entered in New Password . If the passwords are not the same, an error is displayed.
Send	Click this button to confirm the changes made to the Admin Password .

4 User Password

Select the **Enabled** check box to require a password to open the operation window on the computer. The following items can be set.

Configuration Menu

This chapter explains how to use the Configuration menu and its functions.

Using the Configuration Menu

This section explains how to use the Configuration menu.

Although steps are explained using the remote control as an example, you can perform the same operations from the control panel. Check the guide under the menu for the available buttons and their operations.

1 Display the Configuration menu screen.

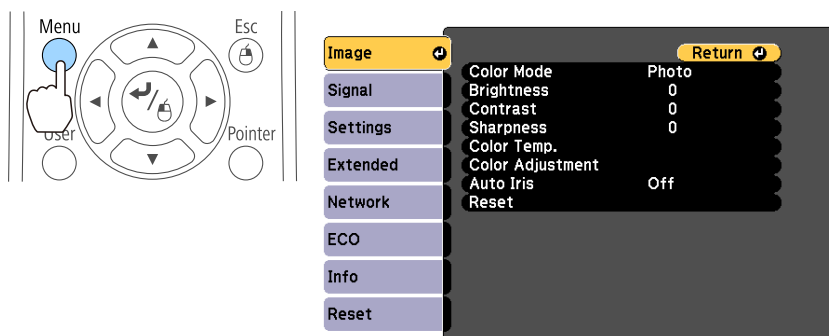

2 Select a top menu item.

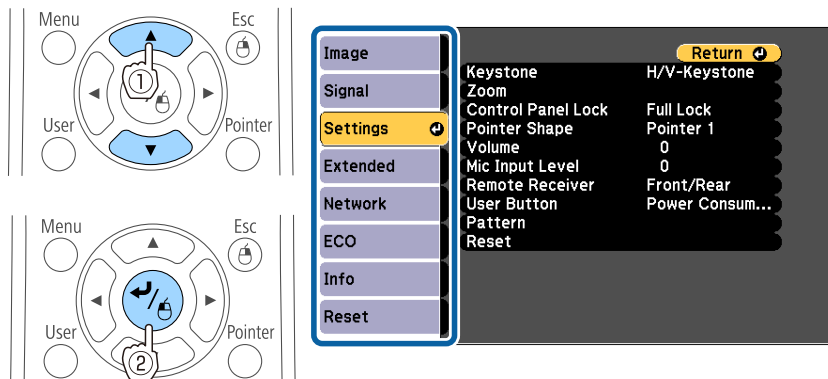

3 Select a submenu item.

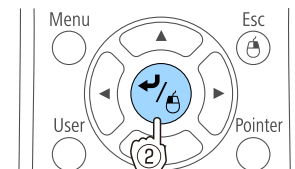
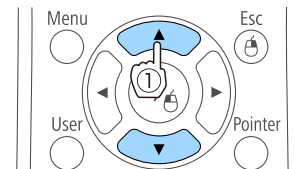

4 Change settings.

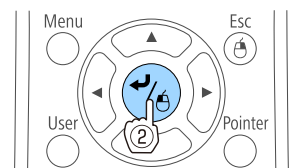
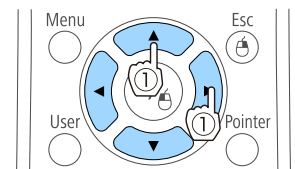





5 Press the [Menu] button

List of Functions



Configuration Menu Table

Settable items vary depending on the model being used and the image signal and source being projected.

Top Menu Name	Submenu Name	Items or Setting Values
Image menu  p.116	Color Mode	Dynamic, Presentation, Theatre, sRGB, Blackboard
	Brightness	-24 to 24
	Contrast	-24 to 24
	Color Saturation	-32 to 32
	Tint	-32 to 32
	Sharpness	-5 to 5
	Color Temp.	5000K to 10000K, -3 to 6
	Color Adjustment	Red: -16 to 16 Green: -16 to 16 Blue: -16 to 16
Auto Iris	Off, Normal, High Speed	
Signal menu  p.117	Auto Setup	On and Off
	Resolution	Auto, Wide, and Normal
	Tracking	-
	Sync.	-
	Position	Up, Down, Left, and Right
	Progressive	Off, Video, and Film/Auto
	Noise Reduction	Off, NR1, and NR2
	HDMI Video Range	Auto, Normal, and Expanded
	Input Signal	Auto, RGB, and Component
Video Signal	Auto, NTSC, NTSC4.43, PAL, M-PAL, N-PAL, PAL60, and SECAM	







Top Menu Name	Submenu Name
	Aspect
	Overscan
	Image Process
Settings menu  p.119	Keystone
	Zoom
	Control Panel
	Pointer Share
	Volume
	Mic Input
	Remote Rec
	User Button
	Pattern
Extended menu  p.120	Easy Interaction
	Display
	User's Logo

List of Functions

Top Menu Name	Submenu Name	Items or Setting Values
	Projection	Front, Front/Ceiling, Rear, and Rear/Ceiling
	Operation	Direct Power On, High Altitude Mode, Startup Source Search, Auto Power On
	A/V Settings	A/V Output, Audio Output, HDMI Audio Output
	USB Type B	Easy Interactive Function, USB Display/Easy Interactive Function, Wireless Mouse/USB Display
	Language	15 or 35 languages*
ECO menu  p.133	Power Consumption	Normal and ECO
	Light Optimizer	On and Off
	Sleep Mode	On and Off
	Sleep Mode Timer	1 to 30
	A/V Mute Timer	On and Off
	Standby Mode	Communication On and Communication Off
	ECO Display	On and Off
Info menu  p.134	Projector Info	Lamp Hours, Source, Input Signal, Resolution, Video Signal, Refresh Rate, Sync Info, Status, Serial Number, Event ID
	Version	Main, Video
Reset menu  p.135	Reset All	-
	Reset Lamp Hours	-

* The number of supported languages differs depending on the region where the projector is used.

Network menu

Top Menu Name	Submenu Name
Basic menu  p.126	Projector Network
	PJLink Password
	Web Control
	Projector Keypad
Wireless LAN menu  p.127	Connection
	Channel
	SSID Auto Search
	SSID
	Search Access Point
	IP Settings
	IP Address Display
Security menu  p.129	Security
	Passphrase
Wired LAN menu  p.130	IP Settings
	IP Address Display
Mail menu  p.131	Mail Notification
	SMTP Server
	Port Number
	Address 1 Setting Address 2 Setting Address 3 Setting
Others menu  p.132	SNMP

List of Functions

Top Menu Name	Submenu Name	Items or Setting Values
	Trap IP Address 1 and Trap IP Address 2	-
	Priority Gateway	Wired LAN and Wireless LAN
	AMX Device Discovery	On and Off
	Crestron RoomView	On and Off
	Bonjour	On and Off
	Message Broadcasting	On and Off

Image Menu

Settable items vary depending on the image signal and source currently being projected. Setting details are saved for each image signal.

☛ "Automatically Detect Input (Source Search)" [p.43](#)

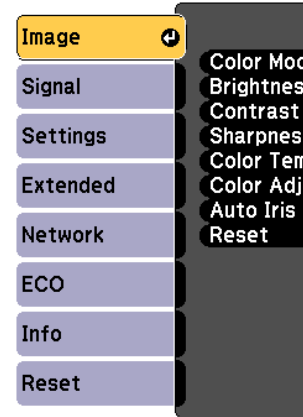

Submenu	
Color Mode	You can select the image source. ☛ "Selecting the Source" p.53
Brightness	You can adjust the brightness of the image.
Contrast	You can adjust the contrast of the image.
Color Saturation	(Adjustment is made for composite video.) You can adjust the color saturation of the image.
Tint	(Adjustment is made for composite video.) You can adjust the tint of the image when an image is being input. Color temperature can be adjusted when an image is being input. You can adjust the tint of the image.
Sharpness	You can adjust the sharpness of the image.

List of Functions

Submenu	Function
Color Temp.	You can adjust the overall tint of the image. The image is tinted blue when a high value is selected and tinted red when a low value is selected. Values that can be adjusted depend on the Color Mode settings. For sRGB : From 5000K to 10000K in 10 steps For other settings: From -3 to 6 in 10 steps
Color Adjustment	(This item cannot be selected if Color Mode is set to sRGB .) You can adjust the color strength for Red , Green , and Blue individually.
Auto Iris	(This item can be set only if Color Mode is set to Dynamic or Theatre .) Set to Normal or High Speed to adjust the iris to obtain the optimum light for images being projected. Select High Speed to make faster iris corrections to match the speed of the scene. The setting is stored for each Color Mode. ☛ "Setting Auto Iris" p.54
Reset	You can reset all adjustment values for the Image menu to their default settings. See the following to return all menu items to their default settings. ☛ "Reset Menu" p.135

Signal Menu

Settable items vary depending on the input being projected. Setting details are provided on page 43.

You cannot make settings on the menu when the projector is in **Display**, **USB**, or **LAN**.

☛ "Automatically Detect Input (Source Search)" p.43

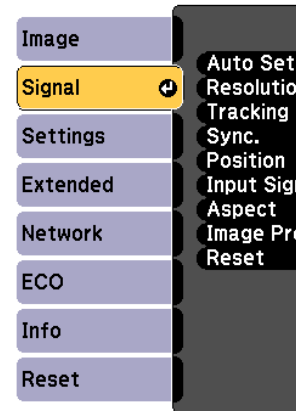

Submenu	Function
Auto Setup	(Only available when using a video input.) Set to On to automatically select the optimum settings for the input.
Resolution	(Only available when using a video input.) Set to Auto to automatically select the resolution of the signal. If images are not displayed, for example if some screens are not connected, or set to a specific resolution.

List of Functions

Submenu	Function
Tracking	(Only available when analog RGB computer signals are being input.) You can adjust computer images when vertical stripes appear in the images.
Sync.	(Only available when analog RGB computer signals are being input.) You can adjust computer images when flickering, fuzziness, or interference appear in the images.
Position	(This item cannot be set when the source is HDMI.) You can adjust the display position up, down, left, and right when a part of the image is missing so that the whole image is projected.
Progressive	<u>Interlace</u> (i) signal is converted to <u>Progressive</u> (p). (IP conversion) Off: Ideal for images with a large amount of movement. Video: Ideal for general video images. Film/Auto: This is ideal for movie films, computer graphics, and animation.
Noise Reduction	(This item cannot be set when Image Processing is set to Fast .) Smooths out rough images converted using progressive. There are two modes. Select your favorite setting. It is recommended that this is set to Off when viewing image sources in which noise is very low, such as for DVDs.
HDMI Video Range	When the projector's HDMI port is connected to a DVD player, set the projector's video range according to the DVD player's video range setting. If you are worried about floating black spots or washed out parts in the image, set to Expanded .
Input Signal	You can select the input signal from the Computer1 port or the Computer2 port. If set to Auto , the input signal is set automatically according to the connected equipment. If colors do not appear correctly when set to Auto , select the appropriate signal according to the connected equipment.



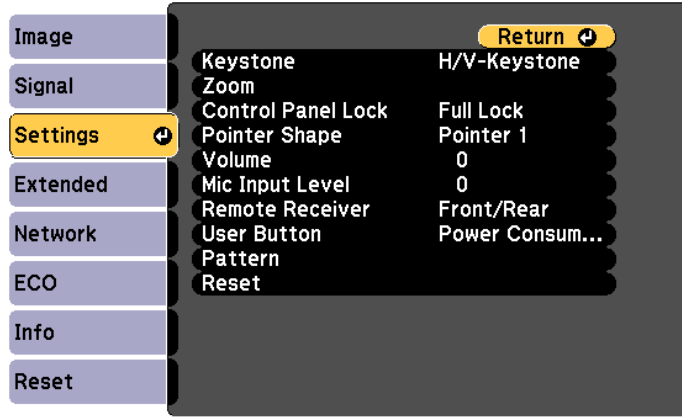

Submenu	Function
Video Signal	You can select the video signal from the Video port. If set to Auto , the signal is set automatically. If a signal error occurs such as no signal, select the appropriate signal according to the connected equipment.
Aspect	You can set the aspect ratio. ☛ "Changing Aspect Ratio"
Overscan	(This setting cannot be set when the source signal is being input.) Changes the overscan of the image. You can select Auto or Off . The Auto setting is changed according to the input signal.
Image Processing	(This item cannot be set when PC Interaction is set to On .) When Fine is selected, the image is projected with high detail. When Fast is selected, the image is projected with less detail. This improves the image quality of interactive features.
Reset	You can reset all settings to default settings. See the following page for the default settings. ☛ "Reset Menu"

List of Functions







Settings Menu



Submenu	Function
Keystone	<p>You can correct keystone distortion.</p> <ul style="list-style-type: none"> When H/V-Keystone is selected: <ul style="list-style-type: none"> Adjust V-Keystone and H-Keystone to correct horizontal and vertical keystone distortion. You can also set H-Keystone Adjuster and Auto V-Keystone to On or Off (EB-536Wi only). <ul style="list-style-type: none"> "H/V-Keystone" p.49 "Auto V-Keystone" p.52 "H-Keystone Adjuster (EB-536Wi only)" p.51 When Quick Corner is selected: <ul style="list-style-type: none"> Select and correct the four corners of the projected image. "Quick Corner" p.49
Zoom	Adjusts the projected image size.
Control Panel Lock	<p>You can use this to restrict operation of the projector's control panel.</p> <ul style="list-style-type: none"> "Restricting Operation (Control Panel Lock)" p.100

Submenu	
Pointer Shape	<p>You can select</p> <p>Pointer 1: </p> <p>Pointer 2: </p> <p>Pointer 3: </p> <p> "Pointer F</p>
Volume	You can adjust source.
Mic Input Level	<p>Adjusts the vol</p> <p>Level is turned</p> <p>When the mic connected dev input level is l becomes loud</p>
Remote Receiver	<p>You can limit remote control</p> <p>When set to Off remote control, hold d at least 15 seco</p>
User Button	<p>You can select assigned to the the [User] butt screen is displ adjustments. Y the [User] butt</p> <p>Power Consum</p> <p>Resolution, M</p> <p>Calibration (E</p>

List of Functions

Submenu	Function
Pattern	<p>Pattern Display: Display a pattern.</p> <p>Pattern Type: You can select from Patterns 1 to 5 or User Pattern. Patterns 1 to 4 display projection lines such as ruled lines or a grid. Pattern 5 displays a test pattern for 4:3 screens. When adjusting the focus for an image projected on a screen with an aspect ratio of 4:3 using EB-536Wi/EB-535W/EB-525W, select Pattern 5.</p> <p>Pattern 1:  Pattern 2: </p> <p>Pattern 3:  Pattern 4: </p> <p>Pattern 5: </p> <p>User Pattern: Captures a user pattern.  "Saving User Pattern" p.96</p> <p>Test Pattern: Displays a test pattern to adjust the projected status without connecting a device. While the test pattern is displayed, zoom, focus adjustments, and keystone correction can be performed. To cancel the test pattern, press the [Esc] button on the remote control or the control panel.</p> <p>When displaying a test pattern on a screen with an aspect ratio of 4:3 using EB-536Wi/EB-535W/EB-525W, set Pattern Type to Pattern 5, and then select Pattern Display.</p> <div style="border: 1px solid black; padding: 5px; margin-top: 10px;"> <p>Attention</p> <p>If a pattern is displayed for a long time, a residual image may be visible in projected images.</p> </div>

Submenu	Function
Reset	<p>You can reset a default setting.</p> <p>See the following settings.</p> <p> "Reset Menu"</p>

Extended Menu

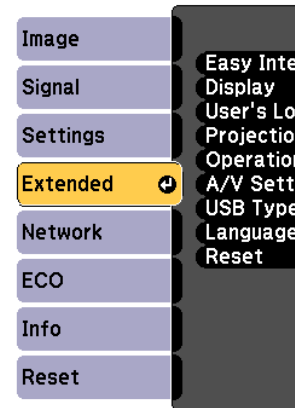

Submenu	Function
Easy Interactive Function (EB-536Wi only)	<p>Allows you to use the Easy Interactive Function.</p> <p> "Using the Easy Interactive Function (EB-536Wi only)" p.123</p>

List of Functions

Submenu	Function
Display	<p>You can make settings related to the projector's display.</p> <p>Messages: When set to Off, the following items will not be displayed.</p> <p>Item names when the Source, Color Mode, or Aspect Ratio is changed, messages when no signal is being input, and warnings such as High Temp Warning.</p> <p>Display Background*1: You can set the screen status for when no image signal is available to Black, Blue, or Logo.</p> <p>Startup Screen*1: Set to On to display the User's Logo when projection starts.</p> <p>A/V Mute*1: You can set the screen displayed when the remote control's [A/V Mute] button is pressed to Black, Blue, or Logo.</p> <p>Toolbars (EB-536Wi only): Set whether or not the drawing toolbar tab is always displayed when using the interactive features. The default is Hide for Set Time.</p> <p>Pen Mode Icon (EB-536Wi only): Set whether or not to always display the icon to change the pen mode when using the interactive features. The icon is hidden when set to Off.</p> <p>Projector Control (EB-536Wi only): Set the display position for the projector control toolbars when using the interactive features. The default value is Bottom. The icon is hidden when set to Off.</p>
User's Logo*1	<p>You can change the user's logo that is displayed as a background during Display Background, A/V Mute, and so on.</p> <p> "Saving a User's Logo" p.95</p>

Submenu	Function
Projection	<p>Select from on depending on Front, Front/C</p> <p>You can change down the [A/V] about five seconds. Front ↔ Front/ Rear ↔ Rear/C  "Installation"</p>
Operation	<p>Direct Power simply by plug When the power turns on automatically being restored.</p> <p>High Altitude above an altitude</p> <p>Startup Source the same source</p> <p>Auto Power On to Communicate projector turns on Computer1 power mode. The default</p>

List of Functions

Submenu	Function
A/V Settings	<p>A/V Output: (Only available when Standby Mode is set to Communication On.)</p> <p>To perform the following functions when the projector is in standby, set to Always On.</p> <ul style="list-style-type: none"> • Outputting audio and images to external devices. • Outputting microphone audio from the projector's speaker. <div style="border: 1px solid black; padding: 5px; margin: 10px 0;">  Although the fan may rotate in standby mode, this is not an abnormality. </div> <p>Audio Output: Set the audio input port when projecting images from the Computer1, Computer2, S-Video, Video, and USB-A ports. When set to Audio1, Audio2, or Audio (L/R), audio is output from the selected port regardless of the source.</p> <p>HDMI Audio Output: Set the input audio when projecting images from the HDMI port. When set to Audio1, Audio2, or Audio (L/R), audio is output from the selected audio input port</p>

Submenu	Function
USB Type B (EB-536Wi only)	<p>Easy Interactiv features to open USB Display are available.</p> <p>USB Display/E the interactive interactive mode function is not available.</p> <p>Wireless Mous Wireless Mouse the interactive interactive mode</p> <ul style="list-style-type: none"> ☛ "Projecting" ☛ "Controlling (Computer Int" ☛ "Using the Pointer (Wirel"
Language	Allows you to
Reset	<p>You can reset Operation*2, and to their default items to their</p> <ul style="list-style-type: none"> ☛ "Reset Me"

*1 Except for **Toolbars**, **Pen Mode**, **Display Background**, **Startup S**, **Protection** is set to **On**.

☛ "Managing Users (Password"

*2 Except for **High Altitude Mod**

*3 Except for **A/V Output**.

List of Functions

Easy Interactive Function Setting Items (EB-536Wi only)

General

Submenu	Function
Auto Calibration	Starts auto calibration.
Manual Calibration	Starts manual calibration.
Pen Mode	(This can only be set when projecting images from a computer.) Changes the function for the interactive pen. When set to PC Free Annotation (default), you can draw on the projected screen. When set to PC Interactive , you can operate a computer from the projected screen. You can change the interactive pen function with the [Pen Mode] button on the remote control, or the pen mode icon on the projected screen.
Hovering	When set to On (default), the pointer follows the pen tip as you hover it over the screen and move it around.

Submenu	
Advanced	<ul style="list-style-type: none"> • Distance of P same room, a the distance b operations ar distance set fo • Sync of Proj same room, s pen interferer is used to syn projectors usi "Connect p.38 • Wired Sync M connections a Sync of Proj also performe the same room connections. • Confirm Cle confirmation content draw • Color Palette palette suitab you find it ha

List of Functions

PC Interactive

Set when you want to operate a computer from the projected screen.

Submenu	Function
Pen Operation Mode	<p>Set the operation mode and the number of users for the interactive pen.</p> <p>Two Users/Mouse (default)/One User/Mouse: Allows you to perform mouse operations using the interactive pen.</p> <p>One User/Pen: The pen input and Ink features are available in Windows 8.1, Windows 8, Windows 7, and Windows Vista.</p>
Enable Right Click	<p>(Only available when Pen Operation Mode is set to Two Users/Mouse or One User/Mouse.)</p> <p>When this is set to On, a long press of the pen tip acts as a right click.</p>
Advanced	<ul style="list-style-type: none"> • Pen Tip Button: Allows you to set operations for the pen tip of the interactive pen. The default setting is Left Click. • Auto Adjust Pen Area: When this is set to On (default), the pen area is automatically adjusted as the resolution for the connected computer changes. Set to Off if you do not want to automatically adjust the pen area that has been manually adjusted. • Manual Adj. Pen Area: Adjusts the pen area manually.

Network Menu

When **Network Protection** is set to **On** in **Password Protection**, a message is displayed and the network settings cannot be changed. Set **Network Protection** to **Off** and then configure the network.

"Setting Password Protection"

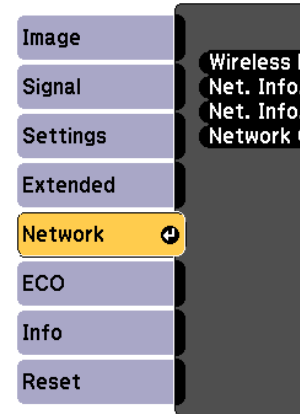

Submenu	
Wireless Mode	<p>Set to Wireless to operate the computer from the projected screen. If you do not want to operate the computer from the projected screen to prevent unauthorized use, set Wireless Mode to LAN.</p>
Net. Info. - Wireless LAN	<p>Displays the network information for the connected computer.</p> <ul style="list-style-type: none"> • Connection • Wireless LAN • Antenna Level • Projector Name • SSID • DHCP • IP Address • Subnet Mask • Gateway Address • MAC Address • Region Code

List of Functions

Submenu	Function
Net. Info. - Wired LAN	Displays the following network setting status information. <ul style="list-style-type: none"> • Projector Name • DHCP • IP Address • Subnet Mask • Gateway Address • MAC Address
Network Configuration	The following menus are available for setting Network items. Basic, Wireless LAN, Security, Wired LAN, Mail, Others, Reset, and Complete

* Displays available region information for the Wireless LAN unit being used. For more details, contact your local dealer or the nearest address provided in the Epson Projector Contact List.

 [Epson Projector Contact List](#)



- By using a Web browser of a computer connected to the projector on a network, you can set functions and control the projector. This function is called Web Control. You can easily enter text using a keyboard to make settings for Web Control such as Security settings.
 -  "Changing Settings Using a Web Browser (Web Control)" [p.102](#)
 - Contact your network administrator for details on network settings.

Notes on Operating the Network Menu

Selecting from the top menu and sub menus, and changing selected items is the same as making operations from the Configuration menu.

When done, make sure you go to the **Complete** menu, and select one of **Yes**, **No**, or **Cancel**. When you select **Yes** or **No**, you are returned to the Configuration menu.

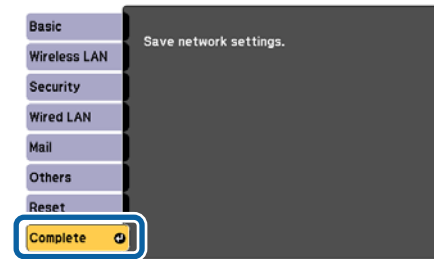

Yes: Saves the settings and exits.

No: Does not save the settings and returns to the previous menu.

Cancel: Continues displaying the menu.

Soft Keyboard Operations

The Network menu contains items that require input during setup. In this case, the following keys are used: the [Left Arrow], [Right Arrow], [Up Arrow], and [Down Arrow] keys; the [Left Bracket], [Right Bracket], [Wide], and [Tele] keys; the [Z], [X], [Y], and [V] keys; the [Caps] key; the [Enter] key; and the [Esc] key. Move the cursor to the key you want, and press the key. Enter the alphanumeric character. Enter the character on the remote control, and press the [Enter] key. Press **Finish** on the keyboard to cancel your input.

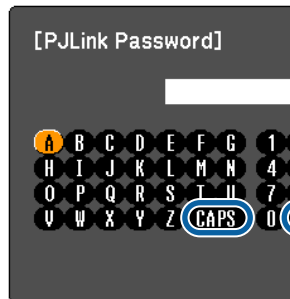

List of Functions

- Each time the **CAPS** key is selected and the [Enter] button is pressed, it switches between upper case and lower case.
- Each time the **SYM1/2** key is selected and the [Enter] button is pressed, it sets and changes the symbol keys for the section enclosed by the frame.

The following text can be entered.

Numbers	0123456789
Alphabet	ABCDEFGHIJKLMNOPQRSTUVWXYZ abcdefghijklmnopqrstuvwxyz
Symbols	! # \$ % & ' () + - . / < = > ? @ ^ _ ` { } ~



- Except for the **SSID**, colons (:) and spaces cannot be entered on the Network menu.
- Some symbols (" * , ; [\]) cannot be entered using the software keyboard. Use your Web browser to enter the text.
- ☛ "Changing Settings Using a Web Browser (Web Control)" [p.102](#)

Basic Menu

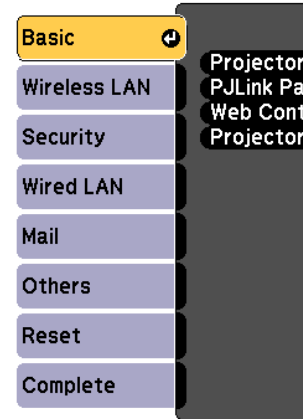

Submenu	
Projector Name	Displays the projector name connected to a computer. When editing, you can enter up to 32 characters (The characters >?[' \]).
PJLink Password	Set a password for connecting to a compatible PJL printer. You can enter up to 32 characters (symbols cannot be entered).
Web Control Password	Set a password for connecting to a projector using Web Control. The password is a 16-byte alphanumeric string. The default password is "admin". Web Control is used to control the projector connected to a computer. ☛ "Changing Settings Using a Web Browser (Web Control)" p.102

List of Functions

Submenu	Function
Projector Key word	<p>When set to On, you have to enter the keyword when you try to connect the projector to a computer via a network. As a result, you can prevent presentations from being interrupted by connections from other computers. Normally this should be set to On.</p> <p>☛ EasyMP Network Projection Operation Guide</p> <p>☛ EasyMP Multi PC Projection Operation Guide</p>

Wireless LAN Menu

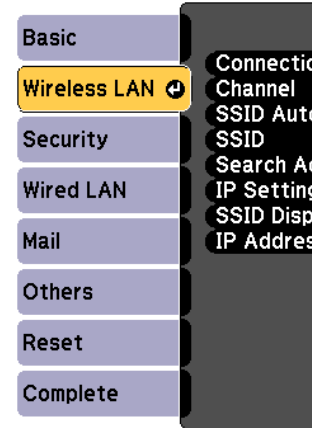

Submenu	Function
Connection Mode	<p>Set the connect and a computer. If you select Quick, automatically b combination with Auto Setting is point. When se mode▶▶.</p> <p>If you select Advanced when network. See the following EasyMP Ne EasyMP M</p>
Channel	<p>(This can only b Select the frequ 6ch, or 11ch. This is set to 11</p>

List of Functions

Submenu	Function
SSID Auto Setting	<p>(This can only be set if Connection Mode is set to Quick.) Set to On to speed up the projector search. Set to Off when connecting to multiple projectors at the same time. This is set to On by default.</p>
SSID	<p>(This item can only be set when SSID Auto Setting is set to Off.) Enter an SSID . When an SSID is provided for the wireless LAN system in which the projector participates, enter the SSID. You can enter up to 32 single-byte alphanumeric characters (^ can only be entered from the Web browser). If the SSID is left blank or set to ANY, an ANY connection (selects a connection from local access points without specifying an SSID) is established.</p>
Search Access Point	<p>When Connection Mode is set to Advanced, you can search for surrounding access points, and set the SSID to be connected from those access points. Depending on the access point settings, they may not be displayed in the list. You must set security separately.</p>



Submenu	Function
IP Settings	<p>(This item can only be set when Connection Mode is set to Advanced.) You can make network settings. DHCP: Set to On to use DHCP. If set to Off, you must set the IP address. IP Address: You can enter the IP address of the projector. You can enter the address. However, the following addresses cannot be used: 0.0.0.0, 127.x.x.x, and numbers from 0 to 255. Subnet Mask: You can enter a subnet mask. However, the following addresses cannot be used: 0.0.0.0, 255.255.255.255, and numbers from 0 to 255. Gateway Address: You can enter the gateway address for the projector. However, the following addresses cannot be used: 0.0.0.0, 127.x.x.x, and numbers from 0 to 255.</p>
SSID Display	<p>To prevent the SSID from being displayed on the Standby screen, set this to Off.</p>
IP Address Display	<p>To prevent the IP address from being displayed on the Standby screen, set this to Off.</p>

List of Functions

Search Access Point screen

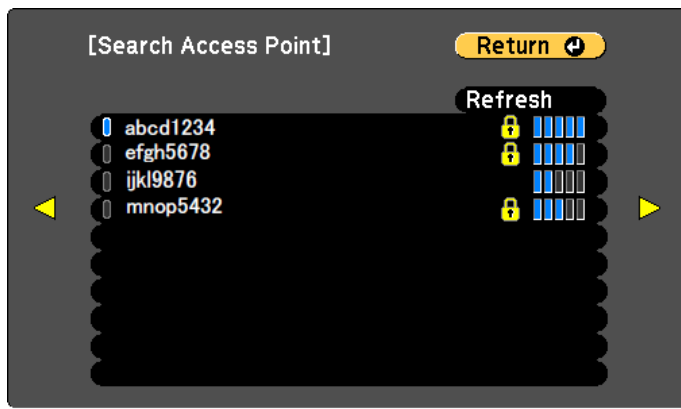
Detected access points are displayed in a list. The application can detect up to 30 access points.



Submenu	Function
Refresh	Searches for the access point again.
	Indicates an already set access point.
	Indicates the access points where security is set. If you select an access point where security has not been set, the Wireless LAN menu is displayed. If you select an access point where security has been set, the Security menu is displayed. Select a type of security according to the security settings for the access point.

Security Menu

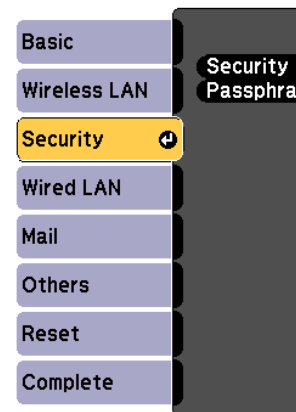

Submenu	
Security	Select the security type. When setting up, you can enter the administrator's password.
Passphrase	(This can only be used when using WPA/WPA2-PSK.) Enter the passphrase (8 to 63 alphanumeric characters). When using wireless LAN, you need to enter the passphrase to enter the password. <ul style="list-style-type: none"> ☛ "Reset Menu" (p.102) You can enter the password when entering the text. ☛ "Changing the Password" (p.102) When Connect is selected, the password is set.

List of Functions

Type of security

When the optional Wireless LAN unit is installed and being used in Advanced connection mode, it is strongly recommended that you set security.

WPA is an encryption standard that improves the security for wireless networks. The projector supports TKIP and AES encryption methods.

WPA also includes user authentication functions. WPA authentication provides two methods: using an authentication server, or authenticating between a computer and an access point without using a server. This projector supports the latter method, without a server.



For setting details, follow the instructions from your network administrator.

Wired LAN Menu

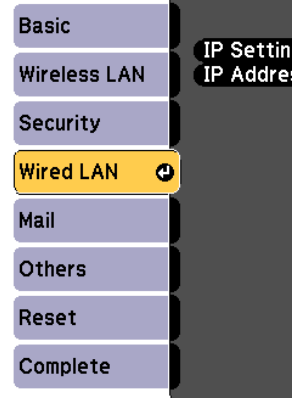

Submenu	
IP Settings	You can make s DHCP ▶▶: Set to is set to On , you IP Address ▶▶: Y projector. You c the address. Ho 0.0.0.0, 127.x.x. number from 0 Subnet Mask ▶▶: You can input a However, the fo 0.0.0.0, 255.255 Gateway Addre for the projecto field of the add cannot be used. 0.0.0.0, 127.x.x. number from 0

List of Functions

Submenu	Function
IP Address Display	To prevent the IP address from being displayed on Network Info in the Network Menu and on the LAN Standby screen, set this to Off.

Mail Menu

When this is set, you receive an email notification if a problem or warning occurs in the projector.

☛ "Using the Mail Notification Function to Report Problems" [p.104](#)

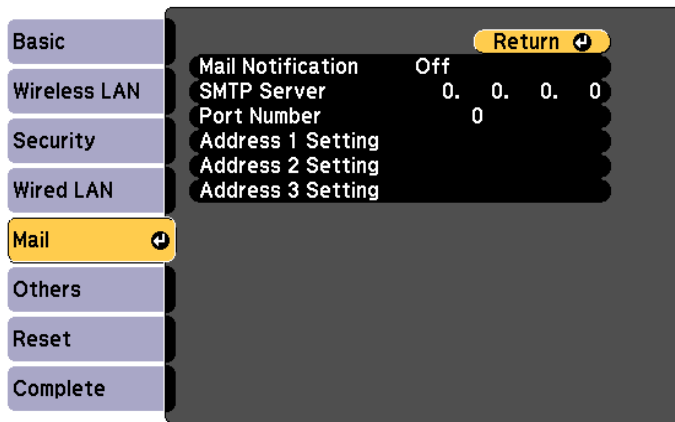

Submenu	Function
Mail Notification	Set to On to send an email to the preset addresses when a problem or warning occurs with a projector.
SMTP Server	You can input the <u>IP address</u> for the SMTP server for the projector. You can enter a number from 0 to 255 in each field of the address. However, the following IP addresses cannot be used. 127.x.x.x, 224.0.0.0 to 255.255.255.255 (where x is a number from 0 to 255)

Submenu	Function
Port Number	You can input the port number for the email notification. The default value is 25. You can enter a number from 0 to 255.
Address 1 Setting/Address 2 Setting/Address 3 Setting	You can input the email address for the notification email. You can enter up to 64 characters for the email address. Allowed characters are: < > [\] The address for the notification email. You can select the email address for the notification email. When the projector reports a problem or warning, an email is sent to the selected address, notifying that a problem or warning has occurred. You can select multiple items.

List of Functions

Others Menu

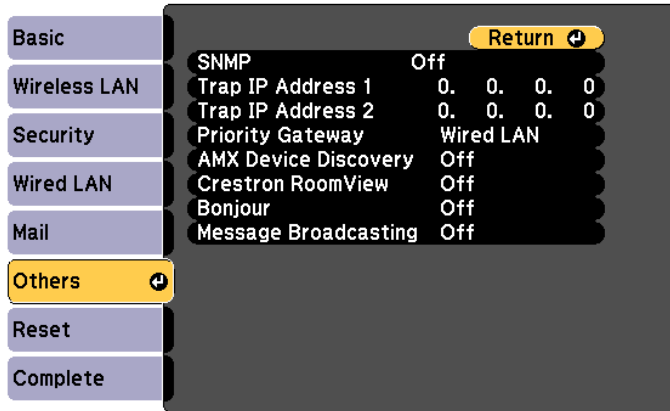

Submenu	Function
SNMP	Set to On to monitor the projector using SNMP. To monitor the projector, you need to install the SNMP manager program on your computer. SNMP should be managed by a network administrator. The default value is Off .
Trap IP Address 1/Trap IP Address 2	You can register up to two IP addresses for the SNMP trap notification destination. You can enter a number from 0 to 255 in each field of the address. However, the following IP addresses cannot be used. 127.x.x.x, 224.0.0.0 to 255.255.255.255 (where x is a number from 0 to 255)
Priority Gateway	You can set the priority gateway to a Wired LAN or Wireless LAN .
AMX Device Discovery	When the projector is connected to a network, set this to On to allow the projector to be detected by <u>AMX Device Discovery</u> . Set this to Off if you are not connected to an environment controlled by a controller from AMX or AMX Device Discovery.

Submenu	
Crestron Room View	Set this to On or Off over the network. Set this to Off . "About Crestron Room View" When this is set to On , the following functions are available: <ul style="list-style-type: none"> • Web Control • Message Broadcasting
Bonjour	Set this to On or Off . See Apple's Web site for more information. http://www.apple.com/airport/
Message Broadcasting	You can switch Message Broadcasting on or off.

List of Functions

Reset Menu

Resets all of the network settings.

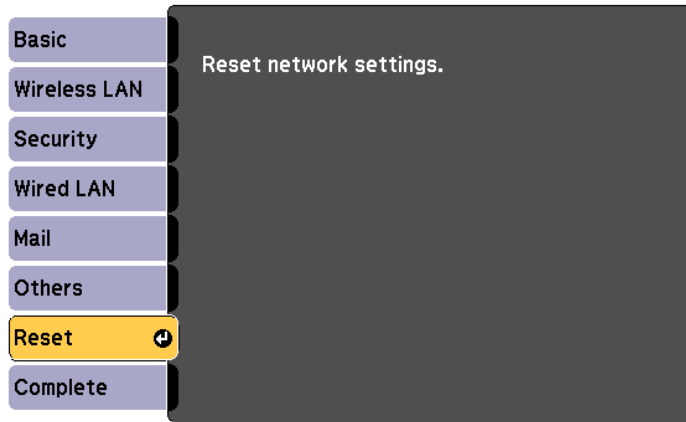

Submenu	Function
Reset network settings.	To reset all of the Network settings, select Yes .

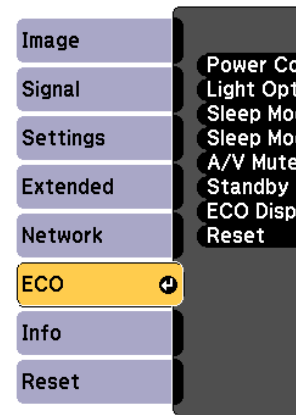

ECO Menu

When you make ECO menu settings, you can save power. When power saving mode is displayed next to each submenu



Submenu	Function
Power Consumption	You can set the power consumption to ECO if the image is being projected. When ECO is selected, the power consumption decreases, and the fan speed decreases.
Light Optimizer	(This item can be set to Normal and Auto .) When set to On , the brightness of the image being projected is reduced, and the electricity being consumed is reduced according to the brightness. The setting is stored.

List of Functions

Submenu	Function
Sleep Mode	When set to On , this automatically stops projection when no image signal is being input and no operations are carried out for a specified length of time. Also, if no image signal is input for a specified length of time, the lamp dims until the power turns off. When an image signal is input, the projector returns to normal operating status.
Sleep Mode Timer	When Sleep Mode is set to On , you can set the time before the projector automatically turns off within a range of 1 to 30 minutes.
A/V Mute Timer	When set to On , this turns off the power automatically 30 minutes after A/V mute is enabled. Also, if A/V mute is enabled and a specified length of time has passed, the lamp dims until the power turns off. When A/V mute is disabled, the projector returns to normal operating status.
Standby Mode	<p>If you set Communication On, you can perform the following operations even if the projector is in standby mode.</p> <ul style="list-style-type: none"> • Monitor and control the projector from a computer over the network • Output audio and images to an external device (only when A/V Output is set to Always On) • Output audio from the projector's speaker (only when A/V Output is set to Always On) <div style="border: 1px solid black; padding: 5px; margin-top: 10px;">  <p>Set Connection Mode to Advanced when monitoring and controlling the projector over wireless LAN.</p> <p> Network - Wireless LAN - Connection Mode p.115</p> </div>
ECO Display	When set to On , when the lamp brightness changes from normal to low or low to normal, leaf icons are displayed at the bottom-left of the projected screen to indicate the power-saving status.

Submenu	
Reset	You can reset a default settings and return all menu items to their default settings.  "Reset Menu"

Info Menu (Display Only)

Lets you check the status of the input source of the projector. Items that can be checked are the currently being projected. Depending on the input sources are not supported.

 "Automatically Detect Input (Source Search)" [p.43](#)

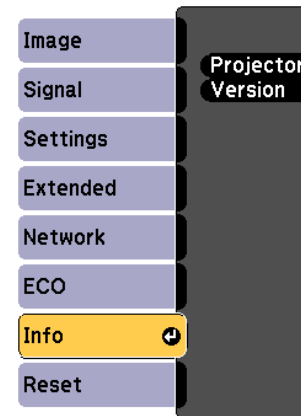

List of Functions

Submenu	Function
Projector Info	<ul style="list-style-type: none"> • Lamp Hours: Displays the cumulative lamp operating time*. When it reaches the lamp warning time, the characters are displayed in yellow. • Source: Displays the source name for the connected equipment currently being projected. • Input Signal: Displays the setting for Input Signal in the Signal menu according to the source. • Resolution: Displays the resolution. • Video Signal: Displays the settings for Video Signal in the Signal menu. • Refresh Rate: Displays the <u>refresh rate</u>▶▶. • Sync Info: Displays the image signal information. This information may be needed if service is required. • Status: Displays the information about errors that have occurred in the projector. This information may be needed if service is required. • Serial Number: Displays the projector's serial number. • Event ID: Displays the problems occurred in the projector using the Event IDs, when the projector and the computer are connected through the network. See the following page for the detailed information on the Event ID.  "About Event ID" p.161
Version	Main/Video: Displays the projector's firmware version.

* The cumulative use time is displayed as "0H" for the first 10 hours. 10 hours and above is displayed as "10H", "11H", and so on.

Reset Menu

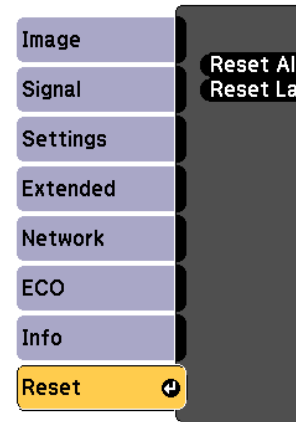

Submenu	
Reset All	You can reset all settings. The following items are reset: Zoom, User's Language, and
Reset Lamp Hours	Clears the cumulative lamp hours. You must replace the lamp.

Performing Batch Setup for Multiple Projectors

Once the Configuration menu content has been set for one projector, you can use it to perform batch setup for multiple projectors (batch setup function). The batch setup function is only for projectors with the same model number.

Use one of the following methods.

- Setup using a USB memory.
- Setup by connecting the computer and projector with a USB cable.
- Setup using EasyMP Network Updater.

This guide explains the USB storage device and the USB cable methods.



The following content is not reflected by the batch setup function.

- Network menu settings (except for Mail and Others menu)
- Lamp Hours and Status from the Info menu
- Perform batch setup before adjusting the projected image. Adjustment values for the projected image, such as Keystone, are also reflected by the batch setup function. If batch setup is performed after adjusting the projected image, the adjustments you made may change.
- By using the batch setup function, the registered User's Logo is set for the other projectors. Do not register confidential information and so on as the User's Logo.



Caution

Performing batch setup is the customers responsibility. If batch setup fails due to a power failure, communication error, and so on, the customer is responsible for any repair costs incurred.



- Use a FAT format USB
- The batch setup function incorporate security function not incorporate security
- The batch setup function USB hard disks.

Saving Settings to a USB Memory

1

Disconnect the power cord of the projector's indicator

2

Connect the USB storage



- Connect the USB storage device is hub, the settings
- Connect an empty device contains settings may not
- If you have saved the USB storage name. The batch setup file.
- The file name for you need to change PJCONFDATA. projector may not
- You can only use

Setting Up Using a USB Memory

This section explains how to perform batch setup using a USB storage device.

Performing Batch Setup for Multiple Projectors

- 3 While holding down the [Esc] button on the remote control or the control panel, connect the power cord to the projector.

The status indicator and the power indicator turn blue, and the lamp indicator and the temperature indicator turn orange.

When all of the projector's indicators turn on, release the [Esc] button.

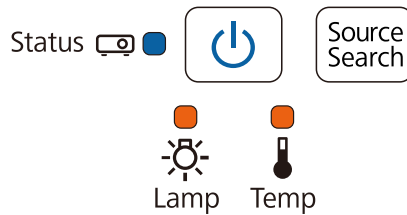

When all of the indicators start flashing, the batch setup file is being written.

Caution

- Do not disconnect the power cord from the projector while the file is being written. If the power cord is disconnected, the projector may not start correctly.
- Do not disconnect the USB storage device from the projector while the file is being written. If the USB storage device is disconnected, the projector may not start correctly.

When writing completes normally, the projector turns off, and only the power indicator is lit blue.

Status 

Lamp

When the power turns off

Reflecting Saved Settings to C

- 1 Disconnect the power cord from the projector's indicator.
- 2 Connect the USB storage file to the projector's USB



- When the USB storage device is connected, the projector reflects the saved settings to the projector's model number. If the projector is not the same model number, the projector may not start correctly.
- When there are multiple USB storage devices connected, the projector may not reflect the settings correctly.
- Do not store any other files on the USB storage device other than the batch setup file. The projector may not reflect the settings correctly.

Performing Batch Setup for Multiple Projectors

- 3 While holding down the [Menu] button on the remote control or the control panel, connect the power cord to the projector.

The status indicator and the power indicator turn blue, and the lamp indicator and the temperature indicator turn orange.

When all of the projector's indicators turn on, release the [Menu] button. The indicators turn on for approximately 75 seconds.

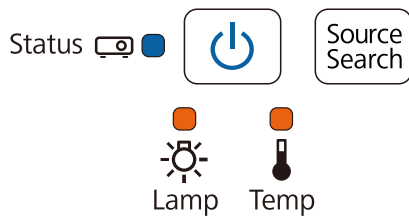

When all of the indicators start flashing, the settings are being written.

Caution

- Do not disconnect the power cord from the projector while the settings are being written. If the power cord is disconnected, the projector may not start correctly.
- Do not disconnect the USB storage device from the projector while the settings are being written. If the USB storage device is disconnected, the projector may not start correctly.

When writing completes normally, the projector turns off, and only the power indicator is lit blue.

Status 

Lamp

When the projector turns off, d

Setup by Connecting the Projector with a USB Cable



The following operating systems are supported:

- Windows Vista and later
- Mac OS X 10.5.3 and later

Saving Settings to a Computer

- 1 Disconnect the power cord from the projector's indicator panel.
- 2 Connect the computer's USB cable to the projector's USB port.

Performing Batch Setup for Multiple Projectors

- 3 While holding down the [Esc] button on the remote control or the control panel, connect the power cord to the projector.

The status indicator and the power indicator turn blue, and the lamp indicator and the temperature indicator turn orange.

When all of the projector's indicators turn on, release the [Esc] button.

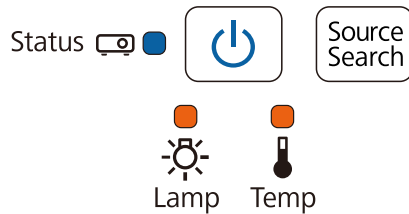

The projector is recognized as a removable disk by the computer.

- 4 Open the removable disk, and save the batch setup file (PJCONFDATA.bin) to the computer.



If you need to change the name of the batch setup file, add text after PJCONFDATA. If you change the PJCONFDATA section of the file name, the projector may not be able to recognize the file correctly. You can only use single-byte characters for the file name.

- 5 Perform "**Remove USB Device**" on the computer, and then disconnect the USB cable.



When using OS X, perform "**Remove EPSON_PJ**".

The projector turns off and only the power indicator is lit blue.

Status

Lamp

Reflecting Saved Settings to C

- 1 Disconnect the power cord of the projector's indicator.

- 2 Connect the computer's with a USB cable.

- 3 While holding down the the control panel, connect

The status indicator and the indicator and the tempera

When all of the projector button.

Status

Lamp

Performing Batch Setup for Multiple Projectors

The projector is recognized as a removable disk by the computer.

- 4 Copy the batch setup file (PJCONFDATA.bin) that you saved to your computer to the toplevel folder of the removable disk.



Do not copy any files or folders other than the batch setup file to the removable disk.

- 5 Perform "**Remove USB Device**" on your computer, and then disconnect the USB cable.



When using OS X, perform "**Remove EPSON_PJ**".

When all of the indicators start flashing, the settings are being written.



Caution

Do not disconnect the power cord from the projector while the settings are being written. If the power cord is disconnected, the projector may not start correctly.

When writing completes normally, the projector turns off, and only the power indicator is lit blue.

Status

Lamp

When Setup Fails

Check

Are the lamp indicator and the temperature indicator flashing orange quickly?

Status



Source Search



Lamp Temp

Are the power indicator and the status indicator flashing blue quickly, and the lamp indicator and the temperature indicator flashing orange quickly?

Status



Source Search



Lamp Temp

Troubleshooting

This chapter explains how to identify problems and what to do if a problem is found.

Using the Help

If a problem occurs with the projector, the Help screen is displayed to assist you by pressing the Help button. You can solve problems by answering the questions.

- 1** Press the [Help] button.
The Help screen is displayed.

Using the remote control

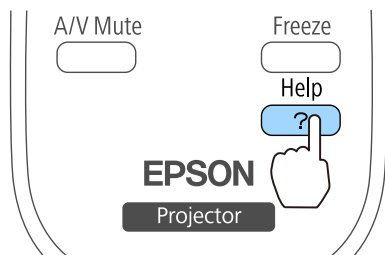

Using the control panel

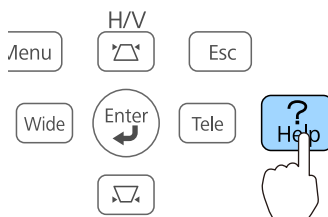

- 2** Select a menu item.

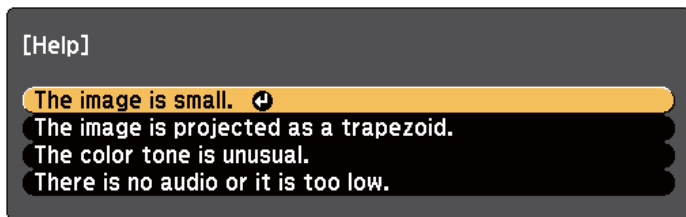

Using the remote control

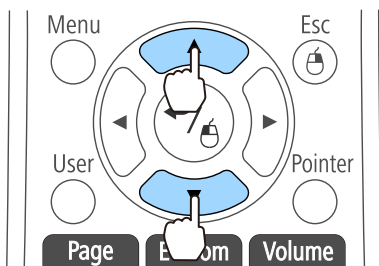

Using the control panel

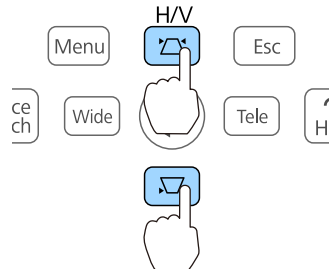

- 3** Confirm the selection.

Using the remote control

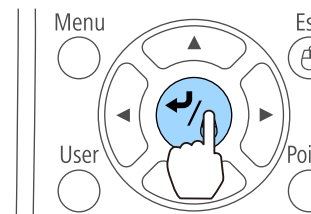

Questions and solutions are displayed.
Press the [Help] button to display the Help screen.

The image is small.

- Is zoom set to minimum?
Change the zoom size.
Zoom ↕
- Is the projector too close?
Move the projector away.



See the following page for the solution to the problem.
☞ "Problem Solving"

Problem Solving

If you are having a problem with the projector, first check the projector's indicators and see "Reading the Indicators" on page 147. See the following if the indicators do not show clearly what the problem might be.

☞ "When the Indicators Provide No Help" [p.147](#)

Reading the Indicators

The projector is provided with the following four indicators that indicate the operating status of the projector.

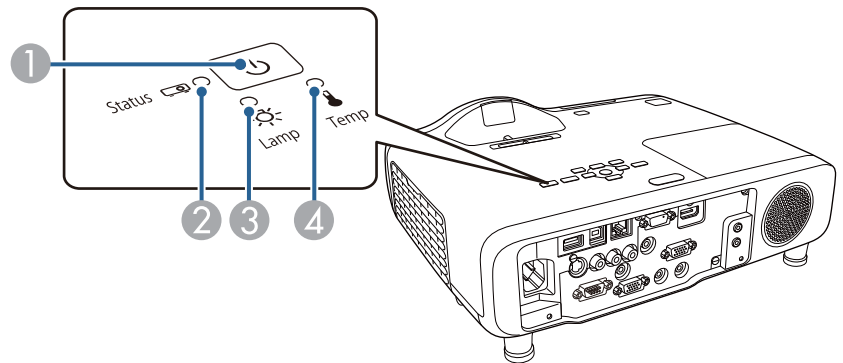

- ① Power indicator
- ② Status indicator
- ③ Lamp indicator
- ④ Temp indicator

Indicates the projector's status.





Indicates the projector's status.

Indicates the lamp's status.

Indicates the internal temperature's status.

Indicators		Status	Explanation
Power supply	Status		
 Blue - Lit	<input type="checkbox"/> Off	Standby condition	Power is being supplied to the projector. When the [⏻] power button is pressed, the projector starts.
		Network monitoring status	The projector is being monitored and controlled over a network (Network Communication On). If the power cord is disconnected and the power button is pressed, the indicator flashes blue.

















Problem Solving

Indicators		Status	Explanation
Power supply	Status		
 Blue - Lit	 Blue - Flashing	Warm-up status	This is the status immediately after turning on the projector. The lamp turns on. In this status you cannot turn off the projector.
		Cool down status	This is the status immediately after turning off the projector.
 Blue - Lit	 Blue - Lit	Normal status	The projector is projecting.

















Refer to the following table to see what the indicators mean and how to remedy problems that they indicate.

If all indicators are off, check that the power cord is connected correctly and that the power is being supplied normally.





Sometimes, when the power cord is unplugged, the [⏻] power indicator remains lit for a short period, but this is normal.

Indicators				Cause	Remedy or
Power supply	Status	Lamp	Temperature		
 Off	 Blue - Flashing	 Orange - Flashing	 Off	Internal Error	Stop using the projector, remove the power plug from the electrical outlet, and contact your local Epson dealer or the nearest address provided in the Epson Projector Contact List.  Epson Projector Contact List
 Off	 Blue - Flashing	 Off	 Orange - Flashing	Fan Error Sensor Error	Stop using the projector, remove the power plug from the electrical outlet, and contact your local Epson dealer or the nearest address provided in the Epson Projector Contact List.  Epson Projector Contact List
 Off	 Blue - Flashing	 Off	 Orange - Lit	High Temp Error Overheating	The lamp turns off automatically and projection stops. After 30 minutes the projector switches to standby mode, so the power indicator turns off. <ul style="list-style-type: none"> • Check that the air filter and air exhaust vent are not blocked or against a wall. • If the air filter is clogged, clean or replace it.  "Cleaning the Air Filter" p.163, "Replacing the Air Filter" p.163 If the error continues after checking the points above, remove the power plug from the electrical outlet, and contact your local Epson dealer or the nearest address provided in the Epson Projector Contact List.  Epson Projector Contact List

Problem Solving

Indicators				Cause	Remedy or
Power supply	Status	Lamp	Temperature		
					When using at an altitude of 1500 m or more, set H ☛ "Extended Menu" p.120
 Off	 Blue - Flashing	 Orange - Lit	 Off	Lamp Error Lamp Failure	<p>Check the following two points.</p> <ul style="list-style-type: none"> • Take out the lamp and check if it is cracked. ☛ "Replacing the Lamp" p.166 • Clean the air filter. ☛ "Cleaning the Air Filter" p.163 <p>If the lamp is not cracked: Reinstall the lamp and p</p> <p>If the error continues: Stop using the projector, remove the power plug from the power outlet, and contact your local dealer or the nearest address provided in the Epson ☛ Epson Projector Contact List</p> <p>If the lamp is cracked: Contact your local dealer or the nearest address provided in the Epson Projector Contact List. (Images cannot be projected) ☛ Epson Projector Contact List</p> <p>When using at an altitude of 1500 m or more, set H ☛ "Extended Menu" p.120</p>
 Off	 Blue - Flashing	 Orange - Flashing	 Orange - Flashing	Auto Iris Error	<p>Stop using the projector, remove the power plug from the power outlet, and contact your local dealer or the nearest address provided in the Epson ☛ Epson Projector Contact List</p>
 Off	 Blue - Flashing	 Orange - Lit	 Orange - Lit	Power Err.	
 Blue - Flashing	 State dependent indication	 State dependent indication	 Orange - Flashing	High Temp Warning	<p>(This is not an abnormality. However, if the temperature is high, the projector will stop automatically.)</p> <ul style="list-style-type: none"> • Check that the air filter and air exhaust vent are not blocked and are not placed against a wall. • If the air filter is clogged, clean or replace it. ☛ "Cleaning the Air Filter" p.163, "Replacing the Air Filter" p.166

Problem Solving

Indicators				Cause	Remedy or
Power supply	Status	Lamp	Temperature		
 Blue - Flashing	 State dependent indication	 Orange - Flashing	 State dependent indication	Replace Lamp	Replace it with a new lamp. 🖱️ "Replacing the Lamp" p.166 If you continue to use the lamp after the replacement may explode increases. Replace it with a new lamp













- See the following if the projector is not operating properly, even though the indicators are all showing normal.
 🖱️ "When the Indicators Provide No Help" [p.147](#)
- If the indicators are in a state not shown in this table, stop using the projector, remove the power plug from the electrical outlet, and contact the nearest address provided in the Epson Projector Contact List.
 🖱️ [Epson Projector Contact List](#)

When the Indicators Provide No Help

If any of the following problems occur and the indicators do not offer a solution, refer to the pages given for each problem.

Problems Relating to Images

<ul style="list-style-type: none">• No images appear Projection does not start, the projection area is completely black or blue.	 p.148
<ul style="list-style-type: none">• Moving images are not displayed (only the moving image portion turns black) Moving images played back from a computer appear black and the images are not projected	 p.149
<ul style="list-style-type: none">• Projection stops automatically	 p.149
<ul style="list-style-type: none">• The message "Not supported" is displayed	 p.149
<ul style="list-style-type: none">• The message "No Signal" is displayed	 p.150
<ul style="list-style-type: none">• Images are fuzzy, out of focus, or distorted	 p.150
<ul style="list-style-type: none">• Interference or distortion appear in images	 p.151
<ul style="list-style-type: none">• The mouse cursor flickers (only when projecting USB display)	 p.152
<ul style="list-style-type: none">• The image is truncated (large) or small, or the aspect ratio is not suitable Only part of the image is displayed, or the height and width ratios of the image are not correct	 p.152
<ul style="list-style-type: none">• Image colors are not right The whole image appears purplish or greenish, images are black & white, or colors appear dull	 p.153
<ul style="list-style-type: none">• Images appear dark	 p.153

Problems when Projection Starts

<ul style="list-style-type: none">• The projector does not turn on	 p.154
---	---

Other Problems

- | |
|---|
| <ul style="list-style-type: none">• No sound can be heard or the sound is distorted |
| <ul style="list-style-type: none">• No sound can be heard from the remote control |
| <ul style="list-style-type: none">• There is noise in the audio (only when projecting) |
| <ul style="list-style-type: none">• The remote control does not work |
| <ul style="list-style-type: none">• I want to change the language for the projector |
| <ul style="list-style-type: none">• Mail is not received even if a problem occurs |
| <ul style="list-style-type: none">• Cannot change settings using a web browser |

Problems with the Interactive Display

- | |
|---|
| <ul style="list-style-type: none">• Cannot draw on the projected screen |
| <ul style="list-style-type: none">• Cannot operate a computer from the projector when connecting to the computer |
| <ul style="list-style-type: none">• The message "An error occurred in the interactive display" is displayed |
| <ul style="list-style-type: none">• Computer's mouse does not work |
| <ul style="list-style-type: none">• The interactive pen does not work |
| <ul style="list-style-type: none">• The response time for the interactive display (when projecting USB display) |
| <ul style="list-style-type: none">• The dot moves automatically or does not move during manual calibration |

Problem Solving

Problems Relating to Images

No Images Appear

Check	Remedy
Did you press the [⏻] power button?	Press the [⏻] power button to turn the power on.
Are the indicators switched off?	The power cord is not connected correctly or power is not being supplied. Connect the projector's power cord correctly. ☛ "Turning On the Projector" p.41 Check that your electrical outlet or power source is functioning correctly.
Is A/V Mute active?	Press the [A/V Mute] button to cancel A/V Mute. ☛ "Hiding the Image and Sound Temporarily (A/V Mute)" p.90
Are the Configuration menu settings correct?	Reset all of the settings. ☛ Reset - Reset All p.135
Is the image to be projected completely black? (Only when projecting computer images)	Some input images, such as screen savers, may be completely black.
Is the image signal format setting correct? (Only when projecting images from a video source)	Change the setting according to the signal for the connected equipment. ☛ Signal - Video Signal p.117
Is the USB cable connected correctly? (Only when projecting USB Display)	Check that the USB cable is connected correctly. Reconnect it if it is not.
Is Windows Media Center displayed in full screen? (Only when projecting using USB Display or network connection)	When Windows Media Center is displayed at full screen, you cannot project. Reduce the screen size.
Is an application using the Windows DirectX function displayed? (Only when projecting using USB Display or network connection)	Applications using the Windows DirectX function may not display in full screen.

Problem Solving

Moving Images are Not Displayed (Only the Moving Image Portion Turns Black)

Check	Remedy
Is the computer's image signal being output to the LCD and the monitor? (Only when projecting images from a laptop computer or a computer with a built-in LCD screen)	Change the image signal from the computer to external output only. Check the computer's manufacturer.
Are the contents of the moving image you are trying to project copyright protected?	The projector may not be able to project copyright protected moving images. For more details, see the user's guide supplied with the player.

Projection Stops Automatically

Check	Remedy
Are Sleep Mode or A/V Mute Timer set to On ?	If any of these are set to On , the power turns off automatically in the following cases: <ul style="list-style-type: none">• When Sleep Mode is set to On: If no operations are performed for a certain period of time with no image being input.• When A/V Mute Timer is set to On: If approximately 30 minutes have passed since the last operation. To prevent the projector from switching off automatically, make sure the following settings are correct: ☛ ECO - Sleep Mode, A/V Mute Timer p.133
Is the computer in power-saving mode?	If the computer is in power-saving mode and no operations are performed for a certain period of time, the image will disappear. Perform an operation on the computer to display the image.

The Message "Not supported" is Displayed

Check	Remedy
Is the image signal format setting correct? (Only when projecting images from a video source)	Change the setting according to the signal for the connected equipment. ☛ Signal - Video Signal p.117
Do the image signal resolution and the refresh rate correspond to the mode? (Only when projecting computer images)	See the documentation supplied with the computer for how to change the mode from the computer. ☛ "Supported Monitor Displays" p.176

Problem Solving

The Message "No Signal" is Displayed

Check	Remedy
Are the cables connected correctly?	Check that all the cables required for projection are securely connected. ☛ "Turning On the Projector" p.41
Is the correct port selected?	Change the image by pressing the [Source Search] button on the remote control. ☛ "Automatically Detect Input Signals and Change the Projected Image" p.41
Is the power of the connected computer or video equipment turned on?	Turn the power on for the equipment.
Are the image signals being output to the projector? (Only when projecting images from a laptop computer or a computer with a built-in LCD screen)	If the image signals are only being output to the computer's LCD monitor, check that the image signals are also output externally. For some computer monitors, when the image signals are output externally, they no longer appear on the LCD monitor or accessory monitor. If the connection is made while the power of the projector or computer is off, the computer's image signal may not be output to the projector. A power cycle that changes the computer's image signal to external output may not work. ☛ "Turning On the Projector" p.41 ☛ Computer's documentation
Is the computer in power-saving mode?	If the computer is in power-saving mode and no operations are performed, the image may disappear. Perform an operation on the computer to display the image.

Images are Fuzzy, Out of Focus, or Distorted

Check	Remedy
Is the focus adjusted correctly?	Move the focus lever to adjust the focus. ☛ "Correcting the Focus" p.53
Is the projector at the correct distance?	Is it projecting outside of the recommended projection distance range? Setup within the recommended range. ☛ "Screen Size and Projection Distance" p.173
Is the Keystone adjustment value too large?	Lower the projection angle to reduce the amount of Keystone correction. ☛ "Adjusting the Image Position" p.52

Problem Solving

Check	Remedy
Is the <u>Aspect Ratio</u> ▶▶ set correctly?	You can change the Aspect Ratio of the projected image to suit the type of the input signals. ☛ "Changing the Aspect Ratio of the Projected Image" p.55
Has condensation formed on the lens?	If the projector is suddenly taken from a cold environment to a warm one, changes occur, condensation may form on the surface of the lens, and the projector up in the room about one hour before it is used. If condensation has formed, wait for the condensation to disappear.

Interference or Distortion Appear in Images

Check	Remedy
Is the image signal format setting correct? (Only when projecting images from a video source)	Change the setting according to the signal for the connected equipment. ☛ Signal - Video Signal p.117
Are the cables connected correctly?	Check that all the cables required for projection are securely connected. ☛ "Connecting Equipment" p.26
Is an extension cable being used?	If an extension cable is used, electrical interference may affect the signal. Check if the cables you are using may be causing the problem.
Is the correct resolution selected? (Only when projecting computer images)	Set the computer so that the signals being output are compatible with the projector. ☛ "Supported Monitor Displays" p.176 ☛ Computer's documentation
Are the <u>Sync</u> ▶▶ and <u>Tracking</u> ▶▶ settings adjusted correctly? (Only when projecting computer images)	Press the [Auto] button on the remote control or the [Enter] button on the projector for automatic adjustment. If the images are not adjusted correctly even after performing automatic adjustments from the Configuration menu. ☛ Signal - Tracking, Sync p.117
Is Transfer layered window selected? (Only when projecting USB Display)	Click All Programs - EPSON Projector - Epson USB Display - Epson Projector and check the Transfer layered window checkbox.

Problem Solving

The Mouse Cursor Flickers (Only when Projecting USB Display)

Check	Remedy
Is Make the movement of the mouse pointer smooth. selected?	Click All Programs - EPSON Projector - Epson USB Display - Epson and uncheck the Make the movement of the mouse pointer smooth. checkbox. (When Windows Aero becomes unavailable if this is selected in Windows 7 a

The Image Is Truncated (Large) or Small, or the Aspect Is Not Suitable

Check	Remedy
Is a wide-panel computer image being projected? (Only when projecting computer images)	Change the setting according to the signal for the connected equipment. ☛ Signal - Resolution p.117
Is the image still being enlarged by E-Zoom?	Press the [Esc] button on the remote control to cancel E-Zoom. ☛ "Enlarging Part of the Image (E-Zoom)" p.92
Is the display position adjusted correctly?	(Only when projecting analog RGB signals input from the Computer) Press the [Auto] button on the remote control or the [Enter] button on the projector. You can also adjust the position from the Configuration menu. ☛ Signal - Position p.117
Is the computer set for dual display? (Only when projecting computer images)	If dual display is activated in the Display Properties of the computer's Control Panel, the computer screen is projected. To display the entire image on the computer screen, deactivate dual display. ☛ Computer video driver documentation
Is the correct resolution selected? (Only when projecting computer images)	Set the computer so that the signals being output are compatible with the projector. ☛ "Supported Monitor Displays" p.176 ☛ Computer's documentation
Is the projection mode correct?	Depending on how the projector is installed, set Projection to one of Rear/Ceiling . ☛ Extended - Projection p.120 ☛ "Installation Methods" p.23

Problem Solving

Image Colors are Not Right

Check	Remedy
Do the input signal settings match the signals from the connected device?	Change the following settings according to the signal for the connected device. <ul style="list-style-type: none"> • When the image is from a device connected to the Computer1 or Computer2 <ul style="list-style-type: none"> ☛ Signal - Input Signal p.117 • When the image is from a device connected to the Video or S-Video <ul style="list-style-type: none"> ☛ Signal - Video Signal p.117
Is the image brightness adjusted correctly?	Adjust the Brightness setting from the Configuration menu. <ul style="list-style-type: none"> ☛ Image - Brightness p.116
Are the cables connected correctly?	Check that all the cables required for projection are securely connected. <ul style="list-style-type: none"> ☛ "Connecting Equipment" p.26
Is the <u>contrast</u>  adjusted correctly?	Adjust the Contrast setting from the Configuration menu. <ul style="list-style-type: none"> ☛ Image - Contrast p.116
Is color adjustment set to an appropriate value?	Adjust the Color Adjustment setting from the Configuration menu. <ul style="list-style-type: none"> ☛ Image - Color Adjustment p.116
Are the color saturation and tint adjusted correctly? (Only when projecting images from a video source)	Adjust the Color Saturation and Tint settings from the Configuration menu. <ul style="list-style-type: none"> ☛ Image - Color Saturation, Tint p.116

Images Appear Dark

Check	Remedy
Is the image brightness set correctly?	Adjust the Brightness and Power Consumption settings from the Configuration menu. <ul style="list-style-type: none"> ☛ Image - Brightness p.116 ☛ ECO - Power Consumption p.133
Is the <u>contrast</u>  adjusted correctly?	Adjust the Contrast setting from the Configuration menu. <ul style="list-style-type: none"> ☛ Image - Contrast p.116
Is it time to replace the lamp?	When the lamp is nearly ready for replacement, the images become dark. Replace the lamp with a new one. <ul style="list-style-type: none"> ☛ "Replacing the Lamp" p.166
Are you using the projector at a high altitude or in a location subject to high temperatures?	The screen may become dark when using at high altitude or in a location with high temperatures. If you cannot make Power Consumption settings at this time, you can continue to use the projector.

Problems when Projection Starts

The Projector Does Not Turn On

Check	Remedy
Did you press the [⏻] power button?	Press the [⏻] power button to turn the power on.
Are the indicators switched off?	The power cord is not connected correctly or power is not being supplied. Disconnect and then reconnect the power cord. ☛ "Turning On the Projector" p.41 Check that your electrical outlet or power source is functioning correctly.
Do the indicators turn on and off when the power cord is touched?	There is probably a poor contact in the power cord, or the power cord is damaged. If this does not solve the problem, stop using the projector, disconnect the power cord, and contact your local dealer or the nearest address provided in the Epson Projector Contact List. ☛ Epson Projector Contact List
Is the Control Panel Lock set to Full Lock ?	Press the [⏻] power button on the remote control. If you do not want to turn the projector Off. ☛ Settings - Control Panel Lock p.119
Is remote control operation restricted?	Check the Remote Receiver from the Configuration menu. ☛ Settings - Remote Receiver p.119

Other Problems

No Sound can be Heard or the Sound is Faint

Check	Remedy
Check that the audio/video cable is securely attached to both the projector and audio source.	Disconnect the cable from the audio input port, and then reconnect it.
Is the projector volume set to the minimum?	Adjust the volume so that sound can be heard. ☛ Settings - Volume p.119 ☛ "Adjusting the Volume" p.53

Problem Solving

Check	Remedy
Is the volume for the computer or from the image source set to the minimum?	Adjust the volume so that sound can be heard.
Is the Mic Input Level set at the maximum?	Lower the Mic Input Level. ☛ Settings - Mic Input Level p.119
Is A/V Mute active?	Press the [A/V Mute] button to cancel A/V Mute. ☛ "Hiding the Image and Sound Temporarily (A/V Mute)" p.90
Is the audio cable's specification "No resistance"?	When using a commercially available audio cable, make sure it is labeled "No resistance".
Is it connected with an HDMI cable?	If no audio is output when connecting via an HDMI cable, set the connection to "HDMI".
Is Output audio from the projector selected? (Only when projecting USB Display)	Click All Programs - EPSON Projector - Epson USB Display - Epson Projector and check the Output audio from the projector checkbox.
Is the correct audio input selected?	Check the Audio Output and HDMI Audio Output settings from the Settings menu. ☛ Extended - A/V Settings p.120

No Sound can be Heard from the Microphone

Check	Remedy
Is the microphone connected correctly?	Disconnect the cable from the Microphone (Mic) input port, and then reconnect it. ☛ "Connecting a Microphone" p.32
Is the microphone input volume turned down too low?	Adjust the microphone input volume so that sound can be heard. ☛ Settings - Mic Input Level p.119
Are you using a plug-in power type microphone?	The projector does not support plug-in power type microphones. Use a standard microphone.

There is Noise in the Audio (Only when Projecting USB Display)

Check	Remedy
Is the volume for the computer set to the minimum while the projector is set to the maximum?	The audio may contain noise if the volume for the computer is set to the minimum and the projector is set to the maximum. Increase the volume for the computer, and decrease the volume for the projector. ☛ Settings - Volume p.119

Problem Solving

The Remote Control Does Not Work

Check	Remedy
Is the remote control light-emitting area pointing towards the remote receiver on the projector during operation?	Point the remote control towards the remote receiver during operation. ☛ "Remote Control Operating Range" p.19
Is the remote control too far from the projector?	The operating range for the remote control is about 6 m. ☛ "Remote Control Operating Range" p.19
Is direct sunlight or strong light from fluorescent lamps shining onto the remote receiver?	Set the projector up in a location where strong light does not shine on it. ☛ Settings - Remote Receiver p.119
Is the correct setting for the Remote Receiver selected?	Check the Remote Receiver from the Configuration menu. ☛ Settings - Remote Receiver p.119
Are the batteries dead or have the batteries been inserted correctly?	Insert new batteries in the correct direction. ☛ "Replacing the Remote Control Batteries" p.18

I Want to Change the Language for Messages and Menus

Check	Remedy
Change the Language setting.	Adjust the Language setting from the Configuration menu. ☛ Extended - Language p.120

Mail is Not Received even if a Problem Occurs in the Projector

Check	Remedy
Is Standby Mode set to Communication On ?	To use the Mail Notification function when the projector is in standby, set the Communication On option in the Configuration menu. ☛ ECO - Standby Mode p.133
Did a fatal abnormality occur and the projector come to a sudden stop?	When the projector comes to a sudden stop, email cannot be sent. If the abnormal state continues, contact your local dealer or the nearest Epson Service Center. ☛ Epson Projector Contact List
Is power being supplied to the projector?	Check that your electrical outlet or power source is functioning correctly.

Problem Solving



Check	Remedy
Is the Mail Notification function set correctly in the Configuration menu?	An error notification email is sent according to the Mail settings in the  "Mail Menu" p.131

Cannot Change Settings Using a Web Browser

Check	Remedy
Are the user ID and password correct?	Enter "EPSONWEB" as the user ID. This cannot be changed. Enter disabled. Enter the password you set in Web Control Password. The initial



Problems with the Interactive Features (EB-536Wi only)

Cannot Draw on the Projected Screen

Check	Remedy
Has pen calibration been performed correctly?	Make sure you perform pen calibration when using the interactive pen and the position of the pen correctly. Also, calibrate the pen again if you notice any discrepancy in position  "Pen Calibration" p.68
Is Pen Mode set to PC Interactive ?	Set Pen Mode to PC Free Annotation from the Configuration menu.  Extended - Easy Interactive Function - Pen Mode p.123
Is the projector installed in direct sunlight from a window, or light from a fluorescent light?	When direct sunlight or light from a fluorescent light shines onto the projector, the interactive features may malfunction. Install the projector in a position that is not in direct sunlight or light from a fluorescent light.

Problem Solving

Cannot Operate a Computer from the Projected Screen After Connecting to the Computer

Check	Remedy
Is Extended set correctly?	Make the following settings: <ul style="list-style-type: none">• Set Pen Mode to PC Interactive from the Configuration menu.  Extended - Easy Interactive Function - Pen Mode p.123• Set USB Type B to Easy Interactive Function or USB Display/Easy Interactive Function from the Configuration menu. When using USB Display, set USB Display/Easy Interactive Function from the Configuration menu.  Extended - USB Type B p.120
Is the Pen Operation Mode set correctly?	When using interactive pens as you would use a mouse, set the Pen Operation Mode to User/Mouse from the Configuration menu.  Extended - Easy Interactive Function - Pen Operation Mode p.123
Is the USB cable connected correctly?	Check the USB cable connections. You may be able to resolve the problem by reconnecting the USB cable.
If you are using a notebook computer when the battery power is running low, the USB port may stop working and you might not be able to use USB devices.	Connect the computer to a power source.

The Message "An error occurred in the Easy Interactive Function." is Displayed

Check	Remedy
An error has occurred in the interactive features.	Contact the nearest address provided in the Epson Projector Contact List.  Epson Projector Contact List

Computer's Mouse Does Not Work Correctly

Check	Remedy
Is the interactive pen placed on the projection screen?	Remove the interactive pen from the projection screen.

Problem Solving



The Dot Moves Automatically or Does Not Move to the Next Position During Manual Calibration

Check	Remedy
Information from the projection screen is not correctly received due to other things, such as a light source that is emitting infrared rays.	Move the device, such as a light source that is emitting infrared rays, away from the device.
Information from the projection screen may not be received correctly if the projector is too close to the screen.	Setup within the recommended projection distance.  "Screen Size and Projection Distance" p.173
The interactive pen is disabled due to unstable conditions in the surrounding area, such as a light source that is emitting infrared rays.	Move the projector or turn off the interfering device, such as a light source.

About Event ID

Check the numbers and then apply the following countermeasures. If you cannot resolve the problem, contact your nearest dealer or the nearest address provided in the Epson Projector Contact List.

[Epson Projector Contact List](#)

Event ID	Cause	
0432 0435	Failed to start EasyMP Network Projection.	Restart the projector.
0434 0482 0484 0485	Network communication is unstable.	Check the network communication while.
0433	Cannot play transferred images.	Restart EasyMP Network Projection.
0481	Communication was disconnected from the computer.	
0483 04FE	EasyMP Network Projection ended unexpectedly.	Check the network communication.
0479 04FF	A system error occurred in the projector.	Restart the projector.
0891	Cannot find an access point with the same SSID.	Set the computer, the access point.
0892	The WPA/WPA2 authentication type does not match.	Check that the wireless LAN security type matches.
0893	The TKIP/AES encryption type does not match.	 Security p.129
0894	Communication was disconnected because the projector connected to an unauthorized access point.	Contact your network administrator.
0898	Failed to acquire DHCP.	Check that the DHCP server is on and turn off the DHCP setting.  Wireless LAN - IP Settings p.129
0899	Other communication errors	If restarting the projector or the computer does not solve the problem, contact your local dealer or the nearest address provided in the Epson Projector Contact List.  Epson Projector Contact List

Maintenance

This chapter provides information on maintenance procedures to ensure the best level of performance from the p

Cleaning

You should clean the projector if it becomes dirty or if the quality of projected images starts to deteriorate.



Caution

Before cleaning, turn off the projector's power and unplug the power cable. Otherwise, it could cause an electric shock.

Cleaning the Projector's Surface

Clean the projector's surface by wiping it gently with a soft cloth.

If the projector is particularly dirty, moisten the cloth with water containing a small amount of neutral detergent, and then firmly wring the cloth dry before using it to wipe the projector's surface.

Attention

Do not use volatile substances such as wax, alcohol, or thinner to clean the projector's surface. The quality of the case may change or become discolored.

Cleaning the Lens

Use a commercially available cloth for cleaning glasses to gently wipe the lens.



Warning

Do not use sprays that contain flammable gas to remove dust and lint from the lens. The projector may catch fire due to the high internal temperature of the lamp inside the projector.

Attention

Do not rub the lens with harsh materials. The lens can easily become damaged.

Cleaning the Air Filter

Clean the air filter and the air intake fan if the projector is displaying a warning message.

"The projector is overheating. Monitor the temperature and clean or replace the air filter."

Attention

- Dust collecting on the air filter causes the projector to rise, leading to a rise in temperature of the parts. Clean the air filter immediately.
- Do not rinse the air filter in water.

1

After you turn off the projector, the buzzer beeps twice, disconnect the power cord.

2

Open the air filter cover. Place your finger into the hole and pull down to open.

Cleaning

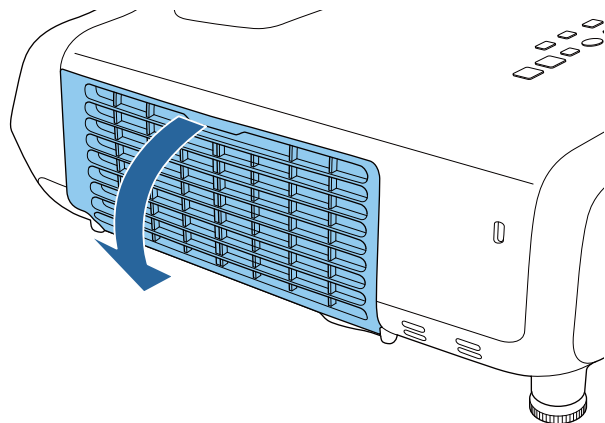

- 3** Remove the air filter.
Grip the tab in the center of the air filter, and pull the air filter straight out.

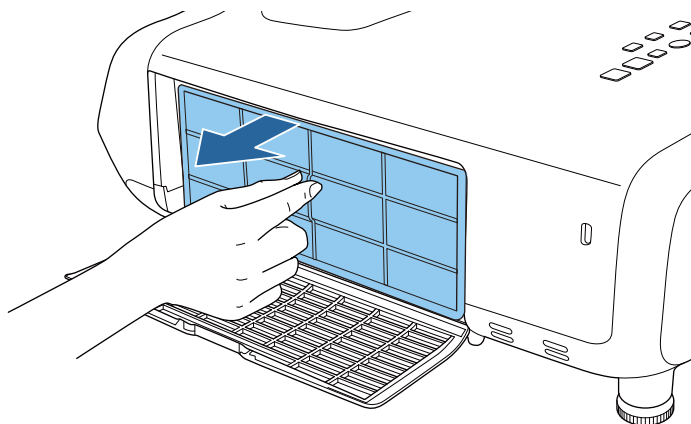

- 4** Remove any dust remaining on the air filter by using a vacuum cleaner from the front.

- 5** Replace the air filter.

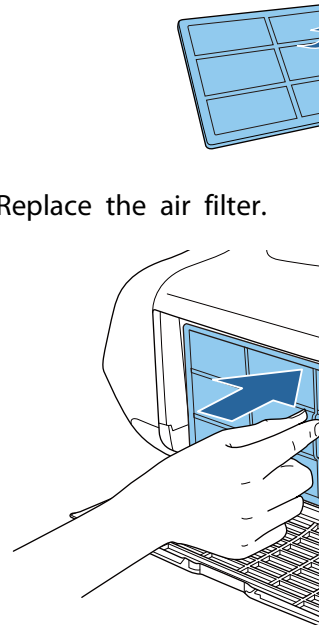

- 6** Close the air filter cover.

Cleaning

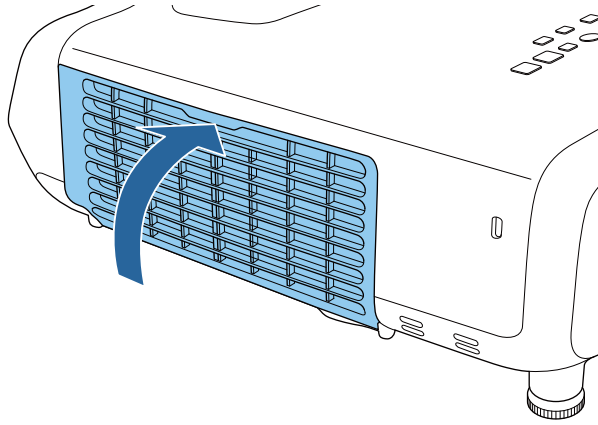

- If a message is frequently displayed, even after cleaning, it is time to replace the air filter. Replace it with a new air filter.
 - ☛ "Replacing the Air Filter" [p.169](#)
- It is recommended that you clean these parts at least once every three months. Clean them more often than this if using the projector in a particularly dusty environment.

Replacing Consumables

This section explains how to replace the lamp and the air filter.

Replacing the Lamp

Lamp Replacement Period

It is time to replace the lamp when:

- The following message is displayed.
"Time to replace the lamp. Please contact your Epson projector reseller or visit www.epson.com to purchase."

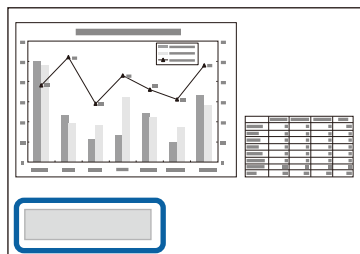

The message is displayed for 30 seconds.

- The power indicator is flashing blue, and the lamp indicator is flashing orange.

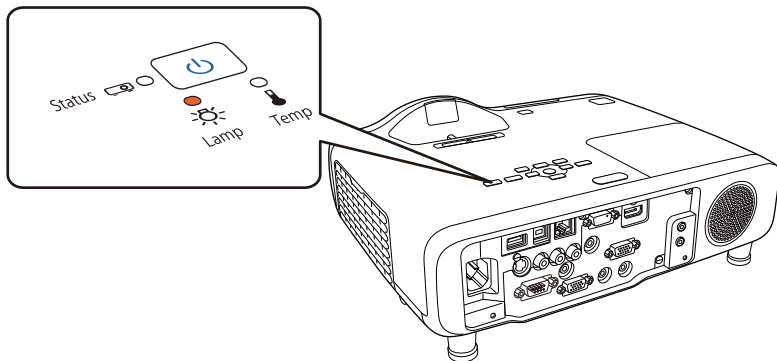

- The projected image gets dark.

Attention

- The lamp replacement message is displayed during periods in order to maintain the quality of the projected images.
When **Power Consumption** is shown, it indicates that the lamp is nearing the end of its life.
When **Power Consumption** is shown, it indicates that the lamp is nearing the end of its life.
• **ECO - Power Consumption** mode is designed to extend the lamp's life.
• If you continue to use the lamp after the replacement message is displayed, there is a possibility that the lamp may explode. If the replacement message is displayed, replace the lamp immediately, even if it is still working.
• Do not repeatedly turn off the projector power on and off frequently.
• Depending on the individual conditions of use, the lamp may become shorter than expected. If the replacement message is displayed, you should always replace the lamp as needed.
• We recommend the use of genuine Epson lamps. The use of non-genuine lamps may affect projector performance and may void Epson's warranty.



We recommend that you use genuine Epson lamps.

• "Cleaning the Air Filter"

How to Replace the Lamp

The lamp can be replaced even when the projector is on the floor or ceiling.

Replacing Consumables

Warning

- When replacing the lamp because it has stopped working, there is a possibility that the lamp may be cracked. When replacing the lamp of a projector that has been installed on a wall or ceiling, assume that the lamp is cracked and stand to the side of the lamp cover, not underneath it. Also, remove the lamp cover gently. Be careful when removing the lamp cover as shards of glass may fall out and could cause an injury. If any shards of glass get into your eyes or mouth, contact your local physician immediately.
- Never disassemble or modify a lamp. If a modified or disassembled lamp is installed in the projector and used, it could cause a fire, electric shock, or an accident.

Caution

Wait until the lamp has cooled down sufficiently before removing the lamp cover. If the lamp is still hot, burns or other injuries may result. It takes approximately one hour after the power has been turned off for the lamp to sufficiently cool down.

- 1** After you turn off the projector's power and the confirmation buzzer beeps twice, disconnect the power cord.
- 2** Wait until the lamp has sufficiently cooled down, and then remove the lamp cover at the top of the projector.
Loosen the Lamp cover fixing screw with the screwdriver supplied with the new lamp unit or a cross-head screwdriver. Slide the lamp cover straight forward and remove it.

- 3** Loosen the two lamp fix

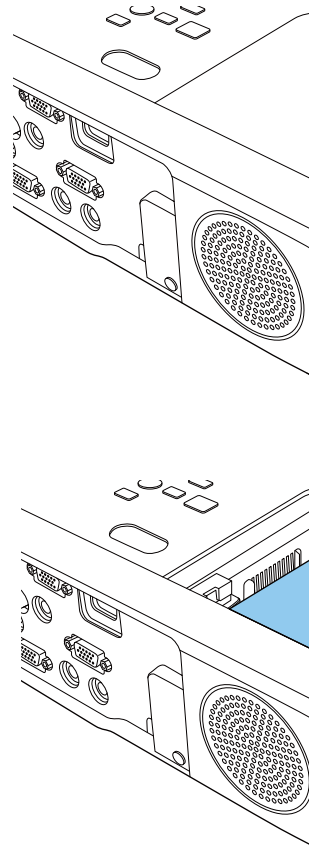

Replacing Consumables

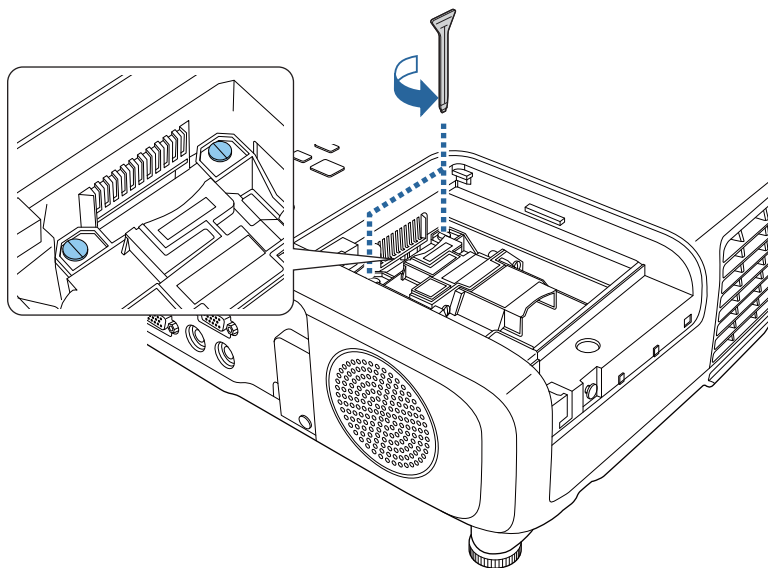

- 4** Grip the raised section of the old lamp and remove it.
If the Lamp is cracked, replace it with a new lamp, or contact your local dealer for further advice.

☛ [Epson Projector Contact List](#)

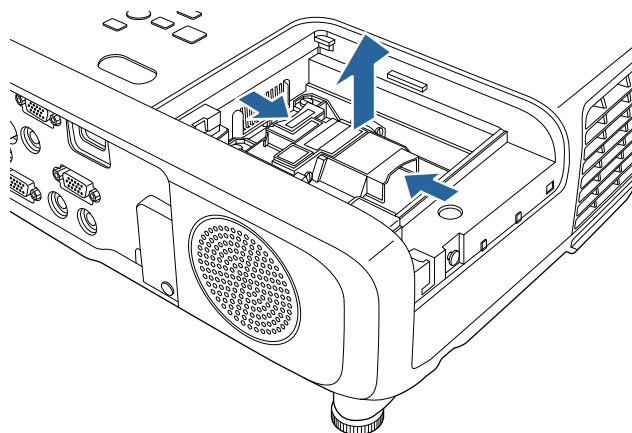

- 5** Install the new lamp.
Insert the new Lamp along the guide, push it in until it fits in place, push the lamp cover down, and tighten the two screws.

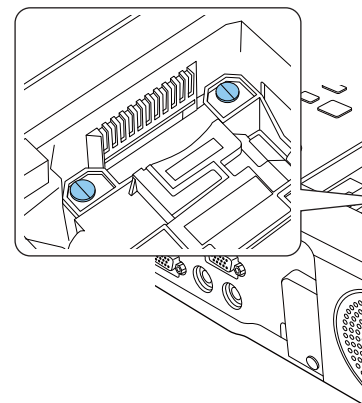
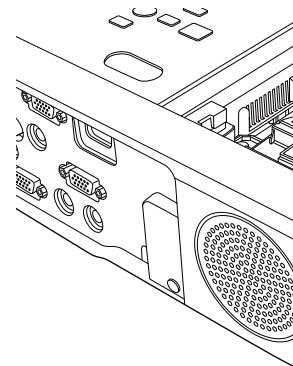

- 6** Replace the lamp cover.

Replacing Consumables

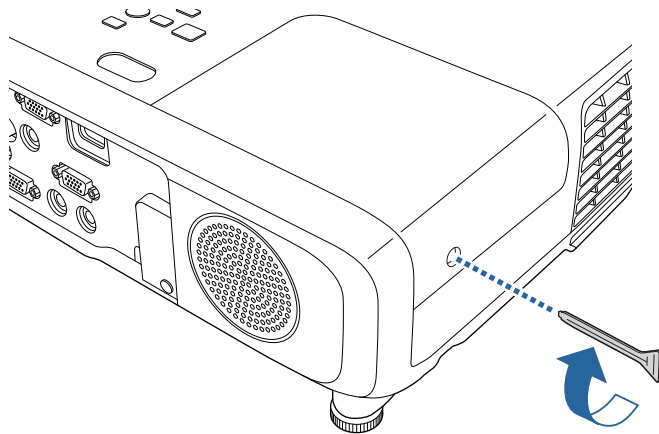

Attention

- Make sure you install the lamp and lamp cover securely. If the lamp cover is removed, the lamps turn off automatically as a safety precaution. If the lamp or the lamp cover is not installed correctly, the lamp will not turn on. Make sure the lamp cover is not loose or deformed.
- This product includes a lamp component that contains mercury (Hg). Please consult your local regulations regarding disposal or recycling. Do not dispose of it with normal waste.

Resetting the Lamp Hours

The projector records how long the lamp is on and a message and indicator notify you when it is time to replace the lamp. After replacing the lamp, make sure you reset the Lamp Hours from the Reset menu.

 **Reset - Reset Lamp Hours** [p.134](#)



Only reset the lamp hours after the lamp has been replaced. Otherwise, the lamp replacement period will not be indicated correctly.

Replacing the Air Filter

Air Filter Replacement Period

If the message is displayed frequently, clean or replace the air filter. If the message is displayed frequently after cleaning, replace the air filter.

How to Replace the Air Filter

The air filter can be replaced even if the projector is mounted on a wall or ceiling.

- 1** After you turn off the projector, the power buzzer beeps twice, disconnect the power cord.
- 2** Open the air filter cover. Place your finger into the cover and pull down to open.

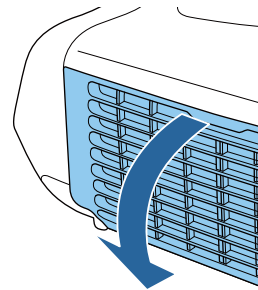

Replacing Consumables

- 3** Remove the air filter.
Grip the tab in the center of the air filter, and pull the air filter straight out.

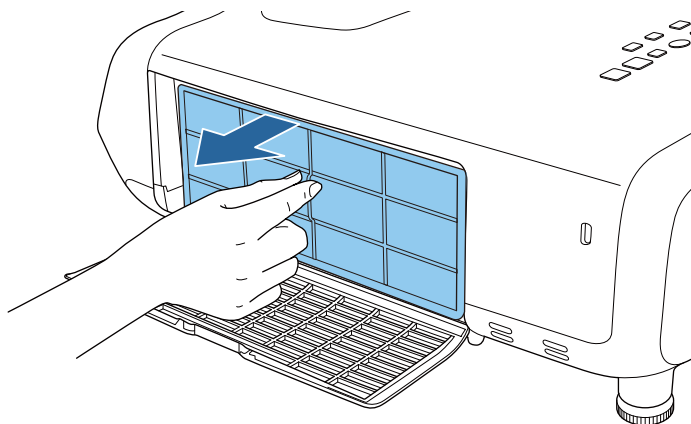

- 4** Install the new air filter.

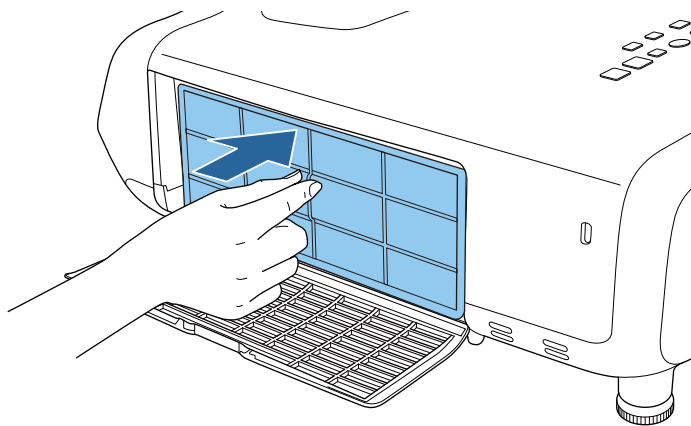

- 5** Close the air filter cover.

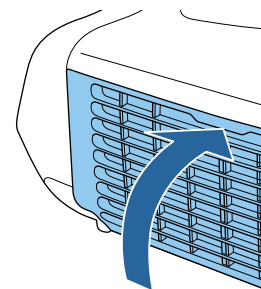

Dispose of used air filter
regulations.
Material of the frame part
Material of the filter part

Appendix

Optional Accessories and Consumables

The following optional accessories and consumables are available. Please purchase these products as and when needed. The following list of optional accessories and consumables is current as of: August, 2014. Details of accessories are subject to change without notice.

Optional Accessories

Wireless LAN unit ELPAP07

Use this to project images from a computer via a wireless communication.

Quick Wireless Connection USB Key ELPAP09

Use when you want to quickly establish one-to-one connection between the projector and a computer with Windows installed.

Document Camera ELPDC06/ELPDC11/ELPDC12/ELPDC20

Use when projecting images such as books, OHP documents, or slides.

Interface box ELPCB02

When the projector is mounted on a wall or suspended from a ceiling, install the remote control to operate the projector at hand.

Soft carrying case ELPKS66

A soft case to carry the projector.

Computer cable ELPKC02

(1.8 m - for mini D-Sub15-pin/mini D-Sub 15pin)

Computer cable ELPKC09

(3 m - for mini D-Sub15-pin/mini D-Sub 15pin)

Computer cable ELPKC10

(20 m - for mini D-Sub15-pin/mini D-Sub 15pin)

Remote control cable set*2 ELPKC28

Cables to connect multiple projectors that support the interactive features.

USB extension cable ELPKC31

Connect to a USB cable if the USB cable is too short.

Component video cable ELPK01 (3 m - for mini D-Sub 15-pin)

Use to connect a component video

Ceiling pipe (450 mm)*1 ELPMB01

Ceiling pipe (700 mm)*1 ELPMB02

Use when installing the projector

Ceiling mount*1 ELPMB23

Use when installing the projector

Wall mount*1 ELPMB45

Use this arm type fitting when in

Easy Interactive Pen*2 ELPPN01

Pens for the interactive features. Y same model number at the same

Interactive Pen Extension*2 ELPPE01

Attach to the Easy Interactive Pen

Replacement Pen Tips*2 ELPPT01

Replacement pen tips for the Easy

*1 Special expertise is required to s it on a wall. Contact your local Epson Projector Contact List.

 [Epson Projector Contact Lis](#)

*2 EB-536Wi only.

Consumables

Lamp unit ELPLP87

Use as a replacement for used lamps.

Air filter ELPAF47

Use as a replacement for used air filter

Screen Size and Projection Distance

Projection Distance (for EB-536Wi/EB-535W/EB-525W)

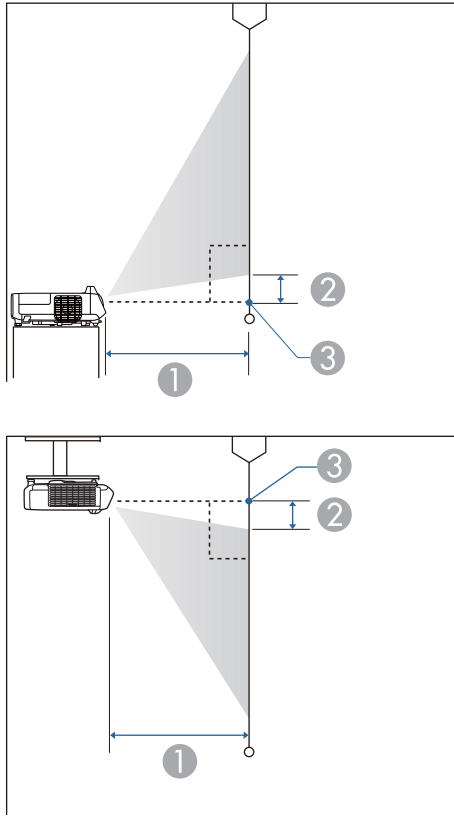

- ① Projection distance (from lens to screen)
- ② Distance from the center of the receiver's lens to the base of the screen (or to the top of the screen, if suspended from a wall or ceiling)
- ③ Center of lens

4:3 Screen Size		Minimum
50"	100 x 76	
60"	120 x 91	
70"	140 x 105	
80"	160 x 120	
90"	180 x 135	
102"	207 x 155	

* Project using Wide (maximum)

16:9 Screen Size		Minimum
60"	130 x 75	
70"	150 x 87	
80"	180 x 100	
90"	200 x 110	
100"	220 x 120	
113"	250 x 141	

* Project using Wide (maximum)

16:10 Screen Size		Minimum
55"	115 x 72	
60"	130 x 81	

Screen Size and Projection Distance

16:10 Screen Size		①	②
		Minimum (Wide) to Maximum (Tele)	Minimum (Wide)
70"	150 x 94	72 - 99	11
80"	170 x 110	83 - 113	13
90"	190 x 120	94*	14
100"	220 x 130	105*	16
116"	251 x 157	122*	18

* Project using Wide (maximum zoom).



- ① Projection distance (from projector to screen)
- ② Distance from the center of lens (or to the top of the screen)
- ③ Center of lens

Projection Distance (For EB-530/EB-520)

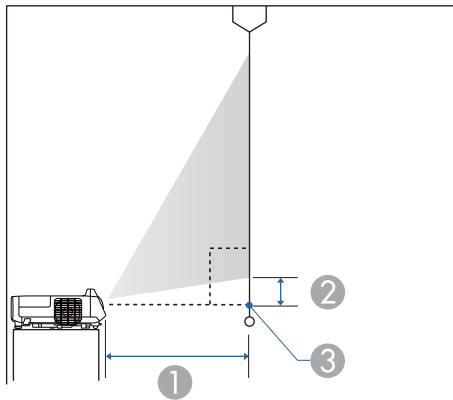

4:3 Screen Size		Minimum
50"	100 x 76	
60"	120 x 91	
70"	140 x 105	
80"	160 x 120	
90"	180 x 135	
100"	200 x 150	
108"	219 x 165	

* Project using Wide (maximum zoom).

Screen Size and Projection Distance

Unit: cm

16:9 Screen Size		①	②
		Minimum (Wide) to Maximum (Tele)	Minimum (Wide)
50"	110 x 62	60 - 82	17
60"	130 x 75	72 - 99	21
70"	150 x 87	85 - 116	24
80"	180 x 100	98*	28
90"	200 x 110	110*	31
99"	219 x 123	121*	34

* Project using Wide (maximum zoom).

Supported Monitor Displays

Supported Resolutions

Computer Signals (analog RGB)

Signal	Refresh Rate (Hz)	Resolution (dots)
VGA	60/72/75/85	640 x 480
SVGA	56/60/72/75/85	800 x 600
XGA	60/70/75/85	1024 x 768
WXGA	60	1280 x 768
	60	1366 x 768
	60/75/85	1280 x 800
WXGA+	60/75/85	1440 x 900
WXGA++	60	1600 x 900
SXGA	70/75/85	1152 x 864
	60/75/85	1280 x 1024
	60/75/85	1280 x 960
SXGA+	60/75	1400 x 1050
WSXGA+*1,2	60	1680 x 1050
UXGA	60	1600 x 1200
MAC13"	67	640 x 480
MAC16"	75	832 x 624
MAC19"	75	1024 x 768
	59	1024 x 768
MAC21"	75	1152 x 870

*1 EB-536Wi/EB-535W/EB-525W only.

*2 Only compatible when **Wide** is selected as the **Resolution** from the Configuration menu.

Even when signals other than the supported signals are input, the image can be projected if the resolution is supported.

Component Video

Signal	Refresh Rate (Hz)
SDTV (480i)	
SDTV (576i)	
SDTV (480p)	
SDTV (576p)	
HDTV (720p)	
HDTV (1080i)	

Composite Video

Signal	Refresh Rate (Hz)
TV (NTSC)	
TV (SECAM)	
TV (PAL)	

Input Signal from the HDMI Port

Signal	Refresh Rate (Hz)
VGA	
SVGA	
XGA	
WXGA	

Supported Monitor Displays

Signal	Refresh Rate (Hz)	Resolution (dots)
WXGA+	60	1440 x 900
WXGA++	60	1600 x 900
SXGA	60	1280 x 960
	60	1280 x 1024
SXGA+	60	1400 x 1050
UXGA	60	1600 x 1200
WSXGA+*	60	1680 x 1050
SDTV (480i/480p)	60	720 x 480
SDTV (576i/576p)	50	720 x 576
HDTV (720p)	50/60	1280 x 720
HDTV (1080i)	50/60	1920 x 1080
HDTV (1080p)	24/30/50/60	1920 x 1080

* EB-536Wi/EB-535W/EB-525W only.

Specifications

Projector General Specifications

Product name		EB-536Wi	EB-535W	EB-525W	
Dimensions		344 (W) x 94 (H) x 314.5 (D) mm (not including			
LCD panel size		0.59" Wide			
Display method		Polysilicon TFT active matrix			
Resolution		1,024,000 WXGA (1280 (W) x 800 (H) dots) x 3			XG
Focus adjustment		Manual			
Zoom adjustment		Digital (1-1.35)			
Lamp		UHE lamp, 215 W Model No.: ELPLP87	UHE lamp, 200 W Model No.: ELPLP87	UHE lamp, 200 W Model No.: ELPLP87	UHE lamp, 200 W Model No.: ELPLP87
Max. audio output		16 W			
Speaker		1			
Power supply		100 - 240 V AC ±10% 50/60 Hz 3.2 - 1.4 A	100 - 240 V AC ±10% 50/60 Hz 3.0 - 1.3 A	100 - 240 V AC ±10% 50/60 Hz 3.0 - 1.3 A	100 - 240 V AC ±10% 50/60 Hz 3.0 - 1.3 A
Power consumption	100 to 120 V area	Operating: 315 W Standby power consumption (Communication On): 1.90 W Standby power consumption (Communication Off): 0.22 W	Operating: 315 W Standby power consumption (Communication On): 1.90 W Standby power consumption (Communication Off): 0.22 W	Operating: 293 W Standby power consumption (Communication On): 1.90 W Standby power consumption (Communication Off): 0.22 W	Operating: 293 W Standby power consumption (Communication On): 1.90 W Standby power consumption (Communication Off): 0.22 W

Specifications

	220 to 240 V area	Operating: 230 W Standby power consumption (Communication On): 2.10 W Standby power consumption (Communication Off): 0.28 W	Operating: 230 W Standby power consumption (Communication On): 2.10 W Standby power consumption (Communication Off): 0.28 W	Operating: 229 W Standby power consumption (Communication On): 2.10 W Standby power consumption (Communication Off): 0.28 W	Opera Stan con (Comm 2 Stan con (Comm 0
Operating altitude	Altitude 0 to 3,000 m				
Operating temperature	+5 to +35°C (No condensation) (Altitude 0 to 2,287 m) +5 to +30°C (No condensation) (Altitude 2,287 to 3,000 m)				
Storage temperature	-10 to +60°C (No condensation)				
Mass	Approx. 3.9 kg	Approx. 3.7 kg	Approx. 3.7 kg	Approx. 3.7 kg	Appr

Specifications

Connectors	Computer1 port	1		M
	Computer2 port	1		M
	Video port	1		
	S-Video port	1		
	Audio1 port	1		
	Audio2 port	1		
	Audio-L/R port	1		R
	Mic port	1		
	Audio Out port	1		
	Monitor Out port	1		M
	HDMI port	1		HDMI (A
	USB-A port*1	1		U
	USB-B port*1	1		U
	LAN port	1		
	RS-232C port	1		M
SYNC port*2	2			

*1 Supports USB 2.0. However, USB ports are not guaranteed to operate all devices that support USB.

*2 EB-536Wi only.

Specifications

This product is also designed for IT power distribution system with phase-to-phase voltage 230V.

Angle of tilt

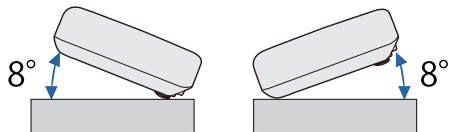

If you use the projector tilted at an angle of more than 8° it could be damaged and cause an accident.

Specifications

DECLARATION of CONFORMITY

According to 47CFR, Part 2 and 15
Class B Personal Computers and Peripherals; and/or
CPU Boards and Power Supplies used with Class B Personal Computers

We: Epson America, Inc.
Located at: 3840 Kilroy Airport Way
MS: 3-13
Long Beach, CA 90806
Tel: 562-981-3840

Declare under sole responsibility that the product identified herein, complies with 47CFR Part 2 and 15 of the FCC rules as a Class B digital device. Each product marketed, is identical to the representative unit tested and found to be compliant with the standards. Records maintained continue to reflect the equipment being produced can be expected to be within the variation accepted, due to quantity production and testing on a statistical basis as required by 47CFR 2.909. Operation is subject to the following two conditions : (1) this device may not cause harmful interference, and (2) this device must accept any interference received, including interference that may cause undesired operation.

Trade Name: EPSON
Type of Product: LCD Projector
Model: H598C/H599C/H600C/H601C/H602C/H603C/
H604C/H605C

FCC Com
For Un

This equipment has been tested as a Class B digital device, pursuant to the FCC rules, and is designed to provide reasonable protection against radio frequency interference in a residential installation. This equipment may emit radio frequency energy and, if not properly installed and used in accordance with the instructions, may cause harmful interference to radio and television reception. However, there is no guarantee of interference in any particular installation. If this equipment causes interference to radio and television reception, which can be determined by turning the equipment off and on, the user is advised to take the following steps to correct the interference by one or more of the following measures:

- Reorient or relocate the receiving antenna.
- Increase the separation between the equipment and the receiver.
- Connect the equipment into an outlet on a circuit different from which the receiver is connected.
- Consult the dealer or an experienced radio/television technician for additional suggestions.

The connection of a non-shielded cable to this equipment will invalidate the FCC certification of this device and may cause interference to other equipment by the FCC for this equipment. If the equipment is used and use a shielded equipment in a residential installation, the equipment has more than one interface connected to unused interfaces. The user is advised to use equipment approved by the manufacturer or a qualified technician for this equipment.

Specifications

FCC Statement for Verification

This device complies with Part 15 of the FCC Rules. Operation is subject to the following two conditions:(1) this device may not cause harmful interference, and (2) this device must accept any interference received, including interference that may cause undesired operation.

Appearance

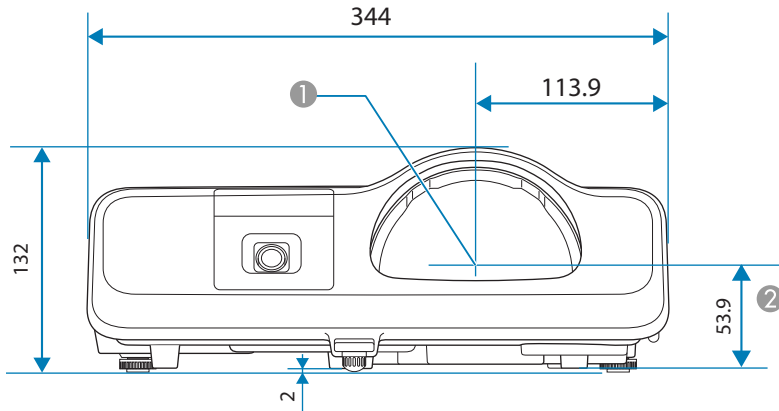

- ① Center of lens
- ② Measurements from the center of the lens to the wall mount plate fixing points or the ceiling mount fixing points.

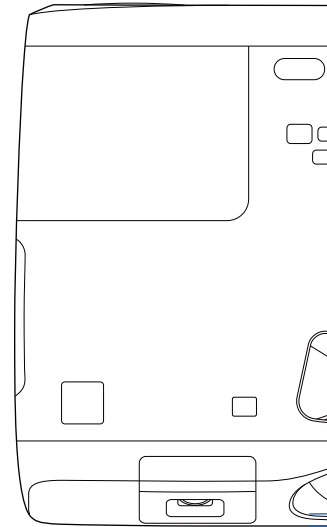

- ③ Measurements from the front o

Appearance

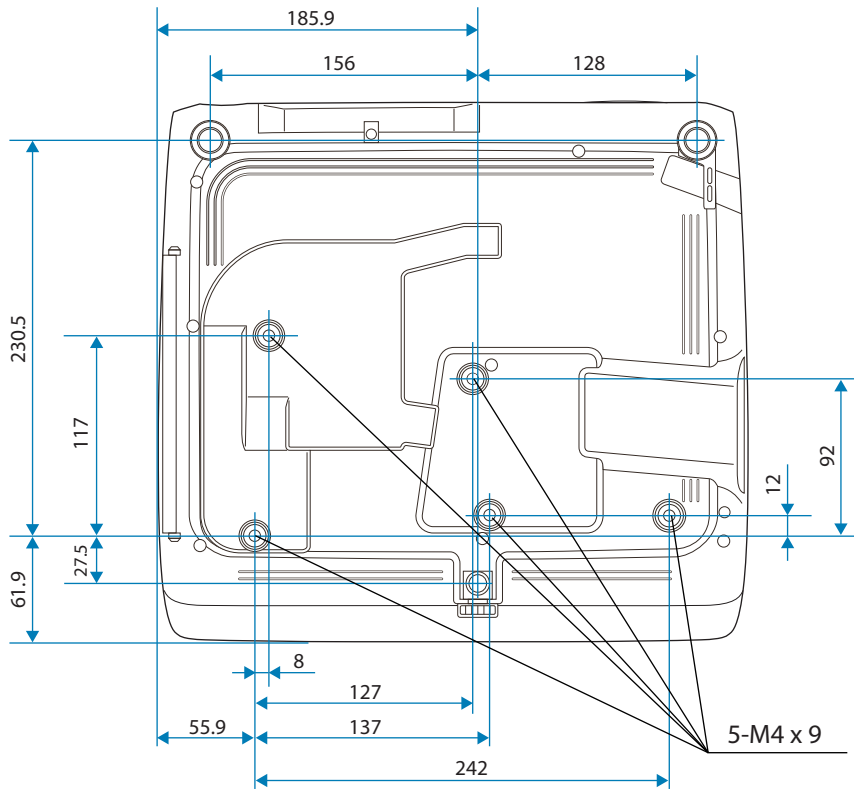

Units: mm

Glossary

This section briefly explains the difficult terms that are not explained in the text of this guide. For details, refer to

Ad hoc mode	A method of wireless LAN connection that communicates with wireless LAN clients without using an access point.
AMX Device Discovery	AMX Device Discovery is a technology developed by AMX to facilitate AMX control systems for Epson projectors. Epson projectors that support AMX Device Discovery have implemented this protocol technology, and have provided a setting to enable the protocol. See the AMX Web site for more details. URL http://www.amx.com/
Aspect Ratio	The ratio between an image's length and its height. Screens with a horizontal:vertical ratio of 16:9, such as HDTV and general computer displays have an aspect ratio of 4:3.
Component Video	A method that separates the video signal into a luminance component (Y), and a blue minus luminance component (Cb) and a red minus luminance component (Pr).
Composite video	A method that combines the video signal into a luminance component and a color component for transmission.
Contrast	The relative brightness of the light and dark areas of an image can be increased or decreased to make the image appear sharper or softer. Adjusting this particular property of an image is called contrast adjustment.
DHCP	An abbreviation of Dynamic Host Configuration Protocol, this protocol automatically assigns an IP address to a computer connected to a network.
Gateway Address	This is a server (router) for communicating across a network (subnet) divided according to subnets.
HDCP	HDCP is an abbreviation for High-bandwidth Digital Content Protection. It is used to prevent illegal copying of digital signals sent over DVI and HDMI ports. Because the HDMI port on this projector supports HDCP technology. However, the projector may not be able to project images protected with updated HDCP technology.
HDTV	An abbreviation for High-Definition Television that refers to high-definition systems which satisfy the following conditions: <ul style="list-style-type: none">• Vertical resolution of 720p or 1080i or greater (p = Progressive, i = Interlace)• Screen aspect ratio of 16:9
Infrastructure mode	A method for wireless LAN connection in which devices communicate through access points.
Interlace	Transmits information needed to create one screen by sending every other line, starting from the top line. Images are more likely to flicker because one frame is displayed every other line.
IP Address	A number to identify a computer connected to a network.
Progressive	Projects information to create one screen at a time, displaying the image for one frame. Even though the amount of flicker in images decreases because the volume of information has doubled compared with an interlaced image.
Refresh Rate	The light-emitting element of a display maintains the same luminosity and color for an extremely short period of time. The light-emitting element is scanned many times per second to refresh the light-emitting element. The number of refresh operations per second is called the refresh rate, expressed in hertz (Hz).

Glossary

SDTV	An abbreviation for Standard Definition Television that refers to standard television systems which Definition Television.
SNMP	An abbreviation for Simple Network Management Protocol, which is the protocol for monitoring computers connected to a TCP/IP network.
sRGB	An international standard for color intervals that was formulated so that colors that are reproduced by computer operating systems (OS) and the Internet. If the connected source has an sRGB mode, set to sRGB.
SSID	SSID is identification data for connecting to another device on a wireless LAN. Wireless communication to SSID.
Subnet Mask	This is a numerical value that defines the number of bits used for the network address on a divided network.
SVGA	A screen size standard with a resolution of 800 (horizontal) x 600 (vertical) dots.
S-Video	A method that separates the video signal into a luminance component (Y) and a color component (C).
SXGA	A screen size standard with a resolution of 1,280 (horizontal) x 1,024 (vertical) dots.
Sync.	The signals output from computers have a specific frequency. If the projector frequency does not match, the image is of a good quality. The process of matching the phases of these signals (the relative position of the crests) is called Synchronization. If the signals are not synchronized, flickering, blurriness, and horizontal interference occur.
Tracking	The signals output from computers have a specific frequency. If the projector frequency does not match, the image is of a good quality. The process of matching the frequency of these signals (the number of crests in the signal) is called Tracking. If the signals do not track out correctly, wide vertical stripes appear in the signal.
Trap IP Address	This is the <u>IP address</u> for the destination computer used for error notification in SNMP.
VGA	A screen size standard with a resolution of 640 (horizontal) x 480 (vertical) dots.
XGA	A screen size standard with a resolution of 1,024 (horizontal) x 768 (vertical) dots.

General Notes

All rights reserved. No part of this publication may be reproduced, stored in a retrieval system, or transmitted in any form or by any means, electronic, mechanical, photocopying, recording, or otherwise, without the prior written permission of Seiko Epson Corporation. No patent liability is assumed with respect to the use of the information contained herein. Neither is any liability assumed for damages resulting from the use of the information contained herein.

Neither Seiko Epson Corporation nor its affiliates shall be liable to the purchaser of this product or third parties for damages, losses, costs, or expenses incurred by the purchaser or third parties as a result of: accident, misuse, or abuse of this product or unauthorized modifications, repairs, or alterations to this product, or (excluding the U.S.) failure to strictly comply with Seiko Epson Corporation's operating and maintenance instructions.

Seiko Epson Corporation shall not be liable against any damages or problems arising from the use of any options or any consumable products other than those designated as Original Epson Products or Epson Approved Products by Seiko Epson Corporation.

The contents of this guide may be changed or updated without further notice.

Illustrations in this guide and the actual projector may differ.

Restriction of Use

When this product is used for applications requiring high reliability/safety such as transportation devices related to aviation, rail, marine, automotive etc.; disaster prevention devices; various safety devices etc; or functional/precision devices etc, you should use this product only after giving consideration to including fail-safes and redundancies into your design to maintain safety and total system reliability. Because this product was not intended for use in applications requiring extremely high reliability/safety such as aerospace equipment, main communication equipment, nuclear power control equipment, or medical equipment related to direct medical care etc, please make your own judgment on this product's suitability after a full evaluation.

Wireless Telegraphy Act

The following acts are prohibited:

- Modifying and disassembling (
- Removing the label of conform

About Notations

Microsoft® Windows® 2000 oper
Microsoft® Windows® XP oper
Microsoft® Windows Vista® op
Microsoft® Windows® 7 operati
Microsoft® Windows® 8 operati
Microsoft® Windows® 8.1 oper

In this guide, the operating syst
2000", "Windows XP", "Windows
"Windows 8.1". Furthermore, the
refer to Windows 2000, Window
Windows 8, and Windows 8.1, a
referred to as, for example, Win
Windows notation omitted.

Mac OS X 10.3.x
Mac OS X 10.4.x
Mac OS X 10.5.x
Mac OS X 10.6.x
OS X 10.7.x
OS X 10.8.x
OS X 10.9.x

In this guide, the operating syst
10.3.x", "Mac OS X 10.4.x", "Mac
10.7.x", "OS X 10.8.x", and "OS X
"OS X" is used to refer to them

General Notes

General Notice:

EPSON is a registered trademark, EXCEED YOUR VISION, ELPLP and their logos are registered trademarks or trademarks of Seiko Epson Corporation.

Mac, Mac OS, and OS X, are trademarks of Apple Inc.

Microsoft, Windows, Windows Vista, PowerPoint, and Windows logo are trademarks or registered trademarks of Microsoft Corporation in the United States and/or other countries.

eneloop® is a registered trademark of the Panasonic Group.

WPA™ and WPA2™ are registered trademarks of Wi-Fi Alliance.

App Store is a service mark of Apple Inc.

Google play is a trademark of Google Inc.

HDMI and High-Definition Multimedia Interface are the trademarks or registered trademarks of HDMI Licensing LLC. 

PJLink trademark is a trademark applied for registration or is already registered in Japan, the United States of America and other countries and areas.

Crestron and Crestron RoomView are registered trademarks of Crestron Electronics, Inc.

All other trademarks are the property of their respective owners and used for identification purpose only.

©SEIKO EPSON CORPORATION 2014. All rights reserved.

Indication of the manufacturer and the importer in accordance with requirements of directive 2011/65/EU (RoHS)

Manufacturer: SEIKO EPSON CORPORATION

Address: 3-5, Owa 3-chome, Suwa-shi, Nagano-ken 392-8502 Japan

Telephone: 81-266-52-3131

Importer: SEIKO EUROPE B.V.

Address: Azië building, Atlas ArenA, Hoogoorddreef 5, 1101 BA Amsterdam Zuidoost
The Netherlands

Telephone: 31-20-314-5000

Index

A

A/V Mute	12, 17, 90, 104
A/V Mute Timer	134
A/V Output	122
A/V Settings	122
Adjusting the tilt	52
Advanced	123, 124
Air exhaust vent	12
Air filter	11, 172
Air Filter Replacement Period	169
Air intake vent	11
AMX Device Discovery	132
Annotation Mode	60, 75
Anti-Theft Lock	101
Aspect	16, 55, 118
Attachment for optional strap or cord	20
Audio Output	122
Audio Settings	13
Audio1 port	12
Audio2 port	13
Audio-L/R port	12
Auto	16
Auto Calibration	68, 123
Auto Iris	54, 117
Auto Power On	121
Auto Setup	117
Auto V-Keystone	52
Automatic correction	52

B

Background	77
Basic menu	126
Battery cover	20

Battery light	20
Blackboard	54
Bonjour	132
Brightness	116
Button	20

C

Cable Layouts	106
Ceiling	121
Ceiling mount	172
Ceiling mount fixing points	14
Ceiling pipe	172
Channel	127
Cleaning	163
Cleaning the air filter	163
Cleaning the Lens	163
Cleaning the Projector's Surface	163
Color Adjustment	117
Color Mode	18, 53, 116
Color Saturation	116
Color Temp.	117
Command List	106
Communications Protocol	107
Component Video	176
Component video cable	172
Composite Video	176
Computer	16, 104
Computer cable	172
Computer Interactive	62
Computer Port	13
Computer Signals	176
Configuration menu	113, 114
Connecting a computer	26

D

Direct	106
Display	116
Display	116
Display	117
Display	106
Documentation	107
Dyna	176

E

Easy	172
Easy	62
Easy	13
Easy	176
EasyM	113, 114
EasyM	26
ECO	

Index

ECO menu 133
Effect 89
Electronic pen 67
Email Address 131
Enable Right Click 124
Enter 15, 17
Esc 15, 18
ESC/VP21 106
Extended menu 120
E-Zoom 17, 92

F

Flip Horizontal 8, 90
Focus 53
Focus ring 11
Foot adjust lever 11
Freeze 17, 91, 104
Front 23, 121
Front adjustable foot 11, 14
Full Lock 100

G

Gateway Address 128, 130

H

H/V-Keystone 49
HDMI 176
HDMI port 13
HDMI Video Range 118
Help 15, 17
Help function 142
High Altitude Mode 121
H-Keystone adjuster 51

H-Keystone Slider 51
Horizontal keystone adjuster 11
Hovering 123
How to Replace the Air Filter 169
How to replace the lamp 166

I

Image height 52
Image menu 116
Image Processing 118
Image size 52
Images 147, 148
Indicators 15, 143
Info menu 134
Ink function 82, 83
Input Signal 118
Input signal 135
Installing 23, 24, 46
Interactive function 10, 24, 74, 157
Interactive Pen Extension 172
Interface box 172
IP Address 131
IP Address Display 128, 131
IP Settings 128, 130

K

Keystone 119
Keystone distortion 48

L

Lamp cover 11
Lamp hours 133
Lamp indicator 143

Lamp
Lamp
LAN
LAN
Lang
Lens
Light

M

Mail
Mail
Manu
Manu
Menu
Mess
Mess
MHL
Mic I
Micro
Moni
Moni
Mous

N

Netw
Netw
Netw
Noise
Num
Num

O

Oper

Index

Operating temperature 179
Operation 121
Optional accessories 172
Overheating 144
Overscan 118

P

Page 17, 104
Part Names and Functions 11
Passphrase 129
Password protect sticker 99
Password Protection 98
Pattern 120
PC Free 8, 85, 86
Pen 76
Pen Calibration 68
Pen input 82, 83
Pen Mode 18, 123
Pen Mode Icon 121
Pen Operation Area 71
Pen Operation Mode 124
Pen tip 20
PJLink 107
PJLink Password 126
Pointer 17, 91
Pointer shape 119
Port Number 131
Position 118
Power 15, 16, 104
Power indicator 143
Power inlet 12
Power On Protection 98
Presentation 54

Priority Gateway 132
Problem Solving 143
Progressive 118
Projection 121
Projection distance 173, 174
Projection lens 11
Projector 41, 42
Projector control toolbar 77
Projector General Specifications 178
Projector Info 135
Projector keyword 127
Projector Name 126
Projector Setup 102

Q

Quick Corner 49, 119
Quick Wireless Connection USB Key 37, 172

R

Reading Mail 105
Rear 23, 121
Rear feet 14
Rear screen 23
Refresh 129
Refresh Rate 135
Remote control 16
Remote control cable set 172
Remote control light-emitting area 18
Remote Receiver 119
Remote receiver 11, 13
Removing USB devices 31
Replacement Pen Tips 172
Replacing batteries 18, 20

Repla
Repla
Repla
Reset
Reset
Reset
Reset
Resol
Rotat
RS-23

S

Scree
Scree
Search
Secur
Secur
Secur
Select
Serial
Settin
Settin
Sharp
Signa
Sleep
Sleep
Slides
SMT
SNM
Soft c
Soft k
Sort C
Sourc

Index

Speaker	13
Specifications	178
sRGB	54
SSID	128
SSID Auto Setting	128
SSID Display	128
Standby Mode	134
Startup Screen	121
Startup Source Search	121
Status indicator	143
Storage temperature	179
Strap attachment hole	17
Subnet Mask	128, 130
Supported Monitor Displays	176
Supported Resolutions	176
S-Video Port	12
Switching images	44
SYNC IN/OUT port	13
Sync Info	135
Sync.	118
System requirements	45

T

Tele	15
Temp indicator	143
Theatre	54
Tint	116
Toolbars	121
Tracking	118
Trap IP address	132

U

Uninstalling	47
--------------------	----

USB	18, 104
USB cable	138
USB Display	45
USB Display/Easy Interactive Function .	122
USB extension cable	172
USB memory	136
USB Storage	85
USB Type B	122
USB-A port	13
USB-B port	13
User	17
User button	119
User Pattern	96
User's Logo	95, 121
User's Logo Protection	98

V

Version	135
Video	16, 104
Video Port	12
Video Signal	135
Video signal	118
Volume	17, 53, 104, 119

W

Wall mount	172
Wall mount plate fixing points	14
Web Control	102, 103
Web Control Password	126
Web Remote	103
When projection starts	154
Whiteboard Mode	61, 75
Wide	15

Wire
Wire
Wire
Wire
Wire
Wire
Z
Zoom

Free Manuals Download Website

<http://myh66.com>

<http://usermanuals.us>

<http://www.somanuals.com>

<http://www.4manuals.cc>

<http://www.manual-lib.com>

<http://www.404manual.com>

<http://www.luxmanual.com>

<http://aubethermostatmanual.com>

Golf course search by state

<http://golfingnear.com>

Email search by domain

<http://emailbydomain.com>

Auto manuals search

<http://auto.somanuals.com>

TV manuals search

<http://tv.somanuals.com>