



User's Guide

Multimedia Projector

EB-U32

EB-W32

EB-W31

EB-X36

EB-X31

EB-S31

EB-U04

EB-W04

EB-X04

EB-S04

EB-U130

EB-W130

EB-X130

EB-S130

EB-X350

EB-X300

EB-S300

Notations Used in This Guide 6

Introduction to Your Projector 7

Projector Features..... 8

Quick and Easy Setup..... 8

Easy Wireless Projection..... 8

Flexible Connectivity..... 9

 Connect with Computers..... 9

 Connect with Mobile Devices..... 10

Projector Parts and Functions 11

Projector Parts - Front..... 11

Projector Parts - Rear..... 12

Projector Parts - Base..... 13

Projector Parts - Control Panel..... 14

Projector Parts - Remote Control..... 15

Setting Up the Projector 18

Projector Placement 19

Projector Setup and Installation Options..... 19

Projection Distance..... 20

Projector Connections 21

Connecting to a Computer..... 21

 Connecting to a Computer for VGA Video and Audio..... 21

 Connecting to a Computer for USB Video and Audio..... 22

 Connecting to a Computer for HDMI Video and Audio..... 23

Connecting to Smartphones or Tablets..... 23

Connecting to Video Sources..... 24

 Connecting to an HDMI Video Source..... 24

 Connecting to a Component-to-VGA Video Source..... 25

 Connecting to an S-Video Video Source..... 26

 Connecting to a Composite Video Source..... 26

Connecting to External USB Devices..... 27

 USB Device Projection..... 27

 Connecting to a USB Device..... 27

 Disconnecting a USB Device..... 28

Connecting to a Document Camera..... 28

Installing Batteries in the Remote Control 29

Remote Control Operation 30

Opening the Lens Cover 31

Using Basic Projector Features 32

Turning On the Projector 33

 Home Screen..... 34

Turning Off the Projector 36

Selecting the Language for the Projector Menus 37

Projection Modes 38

 Changing the Projection Mode Using the Remote Control..... 38

 Changing the Projection Mode Using the Menus..... 38

Adjusting the Image Height..... 40

Image Shape 41

 Auto V-Keystone..... 41

 Correcting the Image Shape with the Horizontal Keystone Slider..... 41

 Correcting the Image Shape with the Keystone Buttons..... 42

 Correcting the Image Shape with Quick Corner..... 43

Resizing the Image with the Zoom Ring..... 46

Resizing the Image with the Buttons 47

Focusing the Image Using the Focus Ring..... 48

Selecting an Image Source 49

Image Aspect Ratio 51

- Changing the Image Aspect Ratio 51
- Available Image Aspect Ratios 51
- Projected Image Appearance with Each Aspect Mode 52
- Color Mode 53**
- Changing the Color Mode 53
- Available Color Modes..... 53
- Setting Auto Iris 53
- Controlling the Volume with the Volume Buttons 55**

Adjusting Projector Features 56

- Projecting Two Images Simultaneously 57**
- Unsupported Input Source Combinations for Split Screen Projection..... 58
- Split Screen Projection Restrictions..... 59
- Projecting a PC Free Presentation..... 60**
- Supported PC Free File Types..... 60
- Precautions on PC Free Projection 60
- Starting a PC Free Slide Show 61
- Starting a PC Free Movie Presentation 62
- PC Free Display Options 63
- Shutting Off the Image and Sound Temporarily 65**
- Stopping Video Action Temporarily 66**
- Zooming Images..... 67**
- Using the Remote Control as a Wireless Mouse..... 68**
- Using the Remote Control as a Pointer..... 70**
- Saving a User's Logo Image 71**
- Color Difference Correction when Projecting from Multiple Projectors..... 73**
- Setting the Projector ID 73
- Selecting the Projector You want to Operate 73
- Matching Multiple-Projector Display Quality 75

- Projector Security Features..... 76**
- Password Security Types 76
- Setting a Password..... 76
- Selecting Password Security Types..... 77
- Entering a Password to Use the Projector 78
- Locking the Projector's Buttons..... 78
- Unlocking the Projector's Buttons 79
- Installing a Security Cable..... 80

Using the Projector on a Network 81

- Wireless Network Projection..... 82**
- Installing the Wireless LAN Module 82
- Selecting Wireless Network Settings Manually..... 83
- Selecting Wireless Network Settings in Windows 85
- Selecting Wireless Network Settings in OS X..... 85
- Setting Up Wireless Network Security..... 85

- Using a QR Code to Connect a Mobile Device..... 87**
- Using Quick Wireless Connection (Windows Only)..... 89**

Monitoring and Controlling the Projector 90

- EasyMP Monitor 91**
- Controlling a Networked Projector Using a Web Browser..... 92**
- Setting Up Projector Network E-Mail Alerts..... 94**
- Network Projector E-mail Alert Messages..... 94
- Setting Up Monitoring Using SNMP..... 95**
- Using ESC/VP21 Commands 96**
- Setting Up for Using ESC/VP21 Commands..... 96
- ESC/VP21 Command List..... 96
- Communications Protocol 96

Adjusting the Menu Settings 98

Using the Projector's Menus 99

Using the On-screen Keyboard..... 100

Available Text Using the On-screen Keyboard 100

Image Quality Settings - Image Menu 101

Input Signal Settings - Signal Menu..... 103

Projector Feature Settings - Settings Menu 105

Projector Setup Settings - Extended Menu 107

Projector Network Settings - Network Menu..... 109

Network Menu - Basic Menu 109

Network Menu - Wireless LAN Menu 110

Network Menu - Security Menu 111

Network Menu - Mail Menu 112

Network Menu - Others Menu 113

Network Menu - Reset Menu..... 113

Projector Setup Settings - ECO Menu 115

Projector Information Display - Info Menu 116

Info Menu - Projector Info Menu 116

Event ID Code List..... 117

Projector Reset Options - Reset Menu 118

Copy Menu Settings to Another Projector (Batch Setup)..... 119

Performing Batch Setup Using a USB Flash Drive 119

Performing Batch Setup Using a USB Cable..... 120

Batch Setup Error Notification 121

Maintaining the Projector 122

Cleaning the Lens..... 123

Cleaning the Projector Case..... 124

Air Filter and Vent Maintenance 125

Cleaning the Air Filter and Vents..... 125

Replacing the Air Filter 125

Projector Lamp Maintenance 127

Replacing the Lamp 127

Resetting the Lamp Timer 130

Replacing the Remote Control Batteries 132

Solving Problems 133

Projection Problems 134

Projector Indicators Status 135

Using the Projector Help Displays..... 137

Solving Image or Sound Problems..... 138

Solutions When No Image Appears..... 138

Solutions When Image is Incorrect Using the USB Display Function 138

Solutions When "No Signal" Message Appears..... 139

Displaying From a Laptop..... 139

Displaying From a Mac Laptop..... 139

Solutions When "Not Supported" Message Appears 140

Solutions When Only a Partial Image Appears..... 140

Solutions When the Image is not Rectangular..... 140

Solutions When the Image Contains Noise or Static..... 141

Solutions When the Image is Fuzzy or Blurry 141

Solutions When the Image Brightness or Colors are Incorrect 142

Solutions to Sound Problems..... 142

Solutions When Image File Names are not Displayed Correctly in PC Free..... 143

Solving Projector or Remote Control Operation Problems 144

Solutions to Projector Power or Shut-Off Problems..... 144

Solutions to Problems with the Remote Control..... 144

Solutions to Password Problems..... 145

Solving Network Problems 146

Solutions When You Cannot Access the Projector Through the Web 146
Solutions When Network Alert E-Mails are not Received..... 146
Solutions When the Image Contains Static During Network Projection 146

Appendix 147

Optional Accessories and Replacement Parts..... 148
 Optional Accessories 148
 Replacement Parts..... 148

Screen Size and Projection Distance..... 149

Supported Monitor Display Resolutions 153

Projector Specifications 155
 Connector Specifications 156

External Dimensions 157

USB Display System Requirements 159

List of Safety Symbols (corresponding to IEC60950-1 A2) 160

Glossary 162



Notices 164
 FCC Compliance Statement..... 164
 Indication of the manufacturer and the importer in accordance with
 requirements of EU directive..... 165
 Restriction of Use 165
 Operating System References..... 165
 Trademarks..... 165
 Copyright Notice..... 166
 Copyright Attribution..... 166

Notations Used in This Guide



Safety Symbols

The projector and its manuals use graphical symbols and labels to indicate content that tells you how to use the projector safely.

Read and carefully follow the instructions that are marked with these symbols and labels to avoid injury to persons or damage to property.

 Warning	This symbol indicates information that, if ignored, could possibly result in personal injury or even death.
 Caution	This symbol indicates information that, if ignored, could possibly result in personal injury or physical damage due to incorrect handling.

General Information Notations

Attention	This label indicates procedures that may result in damage or injury if sufficient care is not taken.
	This label indicates additional information that may be useful to know.
[Button name]	Indicates the name of the buttons on the remote control or the control panel. Example: [Esc] button
Menu/Setting name	Indicates projector menu and setting names. Example: Select the Image menu  Image > Advanced
▶▶	This label indicates links to the related pages.
	This label indicates a page where detailed information regarding a topic can be found.

Introduction to Your Projector

Refer to these sections to learn more about your projector's features and part names.

► **Related Links**

- "Projector Features" [p.8](#)
- "Projector Parts and Functions" [p.11](#)

This projector has a quick and easy setup, and flexible connectivity features.

► Related Links

- "Quick and Easy Setup" [p.8](#)
- "Easy Wireless Projection" [p.8](#)
- "Flexible Connectivity" [p.9](#)

Quick and Easy Setup

- Direct Power On feature to turn on the projector as soon as you plug it in.
- Auto Power On feature to turn on the projector when the projector detects an image signal from the port you specified as the **Auto Power On** source.
- Home screen feature to easily select an input source and useful functions.
- Real-time, automatic vertical keystone correction always displays a rectangular screen (Auto V-Keystone).
- Horizontal keystone adjuster allows you to quickly correct horizontal distortion in the projected image.

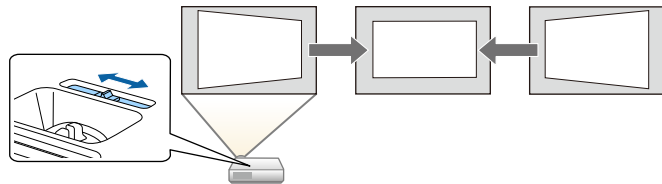

► Related Links

- "Auto V-Keystone" [p.41](#)
- "Projector Setup Settings - Extended Menu" [p.107](#)
- "Turning On the Projector" [p.33](#)
- "Correcting the Image Shape with the Horizontal Keystone Slider" [p.41](#)
- "Correcting the Image Shape with Quick Corner" [p.43](#)

Easy Wireless Projection

- EasyMP Network Projection to share the projector over the network and project images from any of the computers on the network. See the *EasyMP Network Projection Operation Guide* for details.



- Epson iProjection to connect your projector and mobile device wirelessly using the app available on App Store or Google play.



Any fees incurred when communicating with the App Store or Google play are the responsibility of the customer.

- EasyMP Multi PC Projection to project up to four images at the same time by splitting the projected screen. You can project images from computers on the network, or from smartphones or tablet devices on which Epson iProjection is installed.

See the *EasyMP Multi PC Projection Operation Guide* for details.

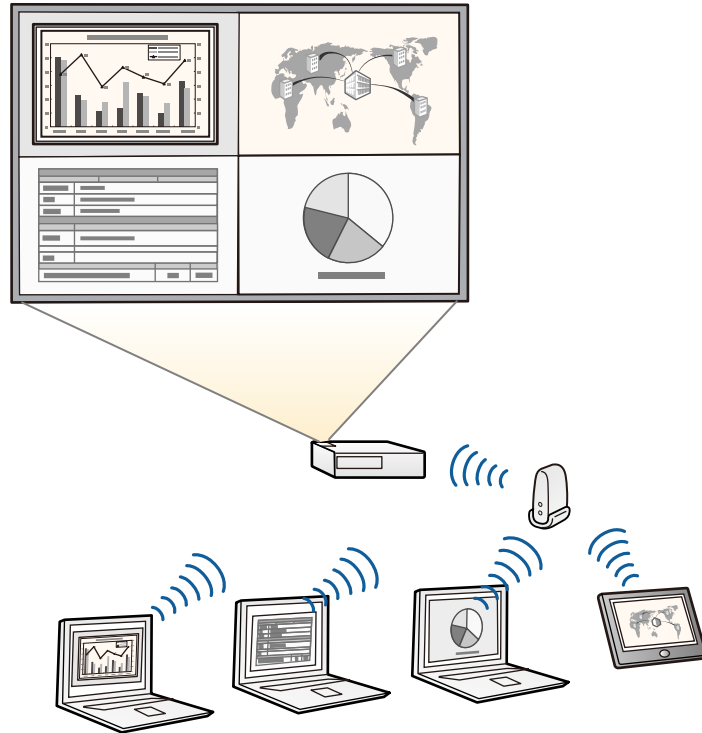

► Related Links

- "Wireless Network Projection" [p.82](#)
- "Using a QR Code to Connect a Mobile Device" [p.87](#)

Flexible Connectivity

This projector supports a wide variety of easy-to-use connectivity options as shown below.

► Related Links

- "Connect with Computers" [p.9](#)
- "Connect with Mobile Devices" [p.10](#)

Connect with Computers

Connect with one USB cable to project images and output audio (USB Display).

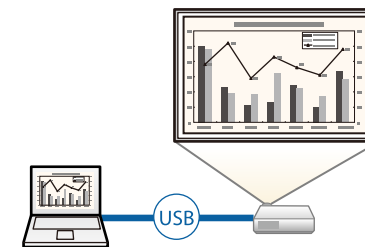

- When projecting images using a wireless LAN, you must install the Epson 802.11b/g/n wireless LAN module, and then set up your projector and computer for wireless projection (EB-W31/EB-X36/EB-X31/EB-S31/EB-U04/EB-W04/EB-X04/EB-S04/EB-U130/EB-W130/EB-X130/EB-S130/EB-X350/EB-X300/EB-S300). The Epson 802.11b/g/n wireless LAN module may not be included with your projector.
- Some models have built-in wireless LAN modules (EB-U32/EB-W32).
- You can download the necessary software and manuals from the following Web site:
<http://www.epson.com/>

Connect with Mobile Devices

- HDMI/MHL port to connect an MHL cable to the mobile device and to the projector.

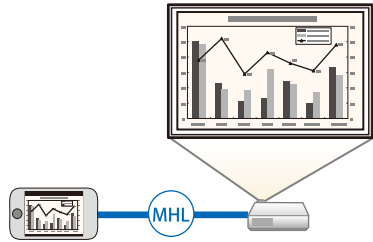

The following sections explain the projector parts and their functions.

► **Related Links**

- "Projector Parts - Front" [p.11](#)
- "Projector Parts - Rear" [p.12](#)
- "Projector Parts - Base" [p.13](#)
- "Projector Parts - Control Panel" [p.14](#)
- "Projector Parts - Remote Control" [p.15](#)

Projector Parts - Front

All of the features in this guide are explained using illustrations of EB-W04 unless otherwise mentioned.

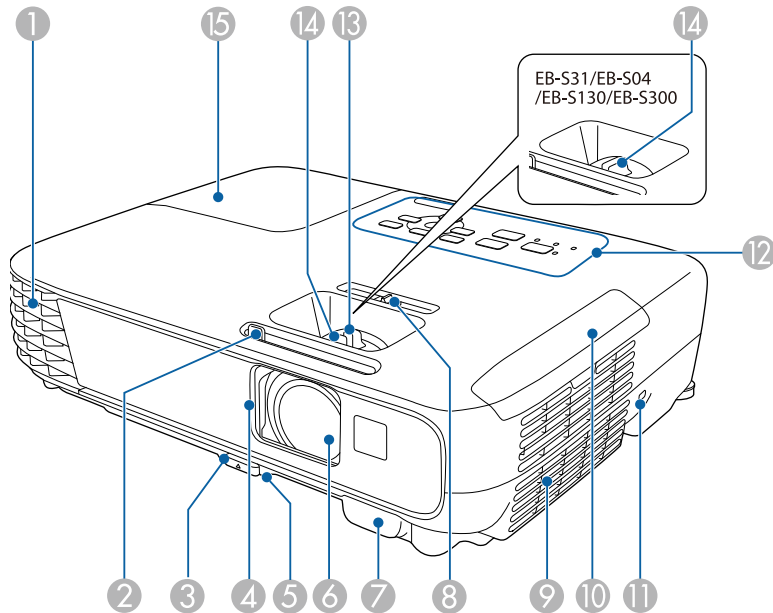

Name	Function
<p>① Air exhaust vent</p>	<p>Exhaust vent for air used to cool the projector internally.</p> <div style="border: 1px solid black; padding: 5px; margin: 5px 0;"> <p>⚠ Warning</p> <p>Do not look into the vents. If the lamp explodes, gases may escape and small fragments of glass may be scattered which could cause an injury. Contact a doctor if any fragments of broken glass are inhaled or get into the eyes or mouth.</p> </div> <div style="border: 1px solid black; padding: 5px; margin: 5px 0;"> <p>⚠ Caution</p> <p>While projecting, do not put your face or hands near the air exhaust vent, and do not place objects that may become warped or damaged by heat near the vent. Hot air from the air exhaust vent could cause burns, warping, or accidents to occur.</p> </div>
<p>② A/V Mute slide lever</p>	<p>Slide the knob to open and close the lens cover.</p>
<p>③ Foot release lever</p>	<p>Press the foot release lever to extend and retract the front adjustable foot.</p>
<p>④ Lens cover</p>	<p>Close when not using the projector to protect the lens. By closing it during projection you can hide the image and the sound.</p>
<p>⑤ Front adjustable foot</p>	<p>When the projector is set up on a surface such as a desk, extend the foot to adjust the position of the image.</p>
<p>⑥ Lens</p>	<p>Images are projected from here.</p>
<p>⑦ Remote receiver</p>	<p>Receives signals from the remote control.</p>
<p>⑧ Horizontal keystone adjuster</p>	<p>Corrects horizontal distortion in the projected image.</p>
<p>⑨ Air intake vent (air filter)</p>	<p>Takes in air to cool the projector internally.</p>
<p>⑩ Air filter cover</p>	<p>Open to access the air filter.</p>

Name	Function
① Security slot	The security slot is compatible with the Microsaver Security System manufactured by Kensington.
⑫ Control panel	Operates the projector.
⑬ Zoom ring (EB-U32/EB-W32/EB-W31/EB-X36/EB-X31/EB-U04/EB-W04/EB-X04/EB-U130/EB-W130/EB-X130/EB-X350/EB-X300)	Adjusts the image size.
⑭ Focus ring	Adjusts the image focus.
⑮ Lamp cover	Open to access the projector's lamp.

► **Related Links**

- "Projector Indicators Status" [p.135](#)
- "Resizing the Image with the Zoom Ring" [p.46](#)
- "Focusing the Image Using the Focus Ring" [p.48](#)

Projector Parts - Rear

EB-W32/EB-W31/EB-X36/EB-X31/EB-S31/EB-W04/EB-X04/EB-S04/EB-W130/EB-X130/EB-S130/EB-X350/EB-X300/EB-S300

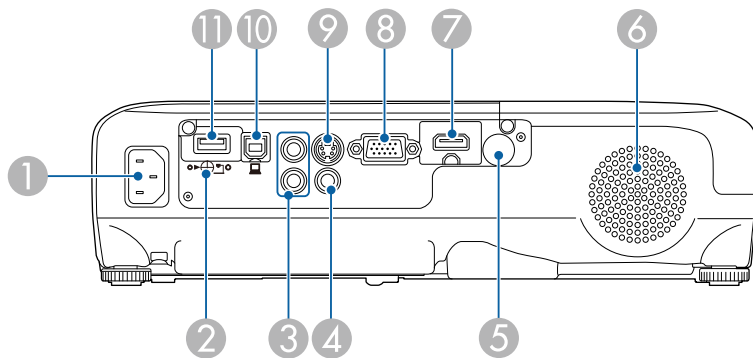

EB-U32/EB-U04/EB-U130

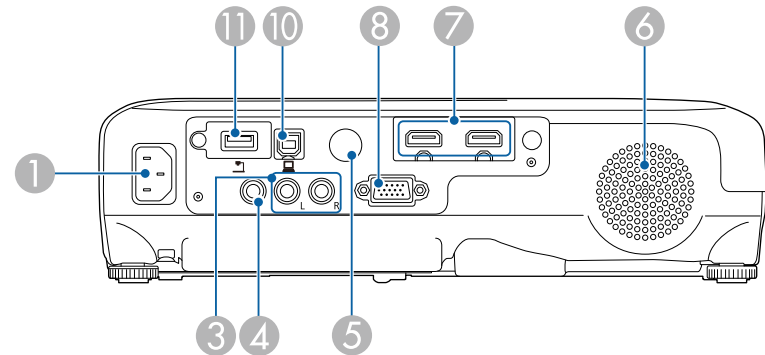

Name	Function
① Power inlet	Connects the power cord to the projector.
② Wireless LAN module fixing screw (EB-W31/EB-X36/EB-X31/EB-S31/EB-W04/EB-X04/EB-S04/EB-W130/EB-X130/EB-S130/EB-X350/EB-X300/EB-S300)	Secures the wireless LAN module cover.
③ Audio ports	Inputs audio from equipment connected to the Computer, S-Video, or Video port.
④ Video port	Inputs composite video signals from video sources.
⑤ Remote receiver	Receives signals from the remote control.
⑥ Speaker	Outputs audio.

Name	Function
<p>7 HDMI port (EB-X36/EB-X31/EB-S31/EB-W04/EB-X04/EB-S04/EB-W130/EB-X130/EB-S130/EB-X350/EB-X300/EB-S300)</p> <p>HDMI/MHL port (EB-W32/EB-W31)</p> <p>HDMI1, HDMI2/MHL port (EB-U32/EB-U04/EB-U130)</p>	<p>Inputs video signals from HDMI compatible video equipment and computers.</p> <p>The HDMI/MHL port can also input video signals from MHL (Mobile High-Definition) compatible mobile devices.</p> <p>This projector is compatible with HDCP.</p>
8 Computer port	Inputs image signals from a computer and component video signals from other video sources.
9 S-Video port (EB-W32/EB-W31/EB-X36/EB-X31/EB-S31/EB-W04/EB-X04/EB-S04/EB-W130/EB-X130/EB-S130/EB-X350/EB-X300/EB-S300)	For S-video signals from video sources.
10 USB-B port	Connects a USB cable to the computer to project computer images or to use the Wireless Mouse function.
11 USB-A port	<p>Connects a USB memory device or a digital camera and projects movies or images using PC Free.</p> <p>Connects the optional Document Camera.</p> <p>Connects the wireless LAN module (EB-W31/EB-X36/EB-X31/EB-S31/EB-U04/EB-W04/EB-X04/EB-S04/EB-U130/EB-W130/EB-X130/EB-S130/EB-X350/EB-X300/EB-S300).</p> <p>Connects the optional Quick Wireless Connection USB Key.</p>

» Related Links

- "Using the Remote Control as a Wireless Mouse" [p.68](#)
- "Installing a Security Cable" [p.80](#)
- "Projecting a PC Free Presentation" [p.60](#)

Projector Parts - Base

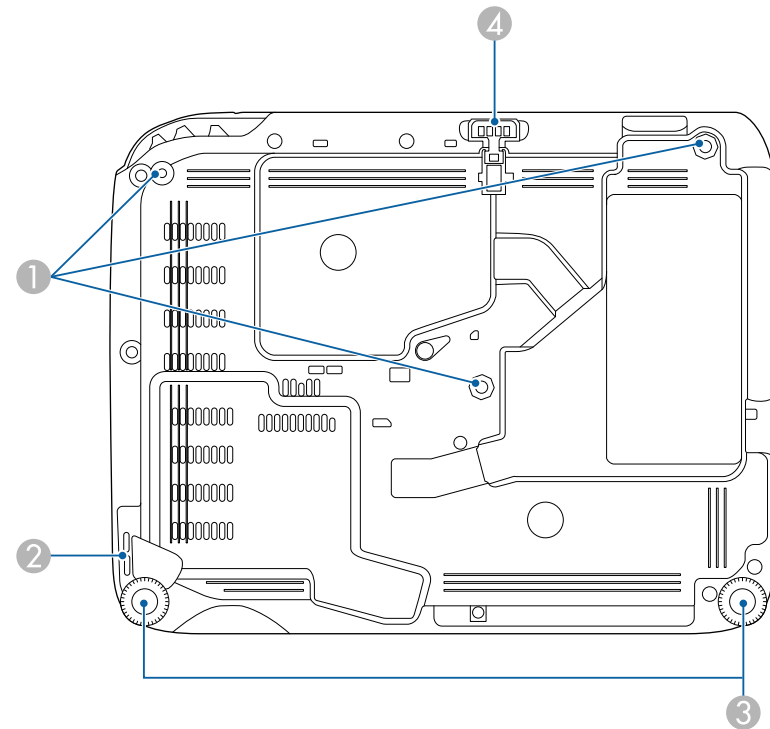

Name	Function
1 Ceiling mount fixing points (three points)	Attach the optional ceiling mount here when suspending the projector from a ceiling.
2 Security cable attachment point	Pass a commercially available wire lock through here and lock it in place.

Name	Function
③ Rear feet	When the projector is set up on a surface such as a desk, turn to extend and retract the feet to adjust the horizontal tilt.
④ Front adjustable foot	When the projector is set up on a surface such as a desk, extend the foot to adjust the position of the image.



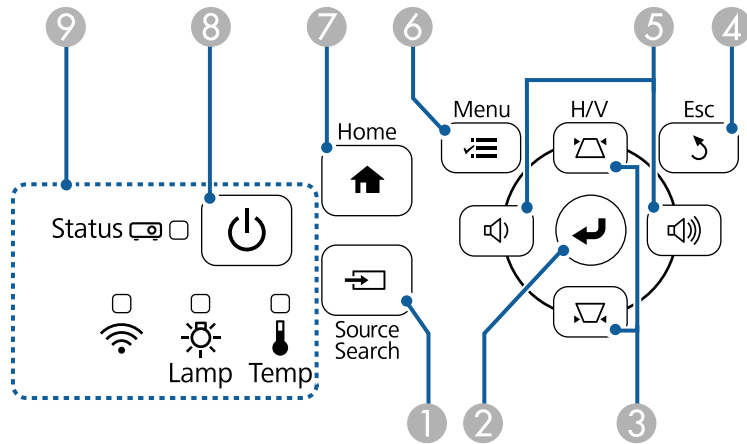

► **Related Links**

- "Installing a Security Cable" p.80

Projector Parts - Control Panel



Name	Function
① [Source Search] button	Changes to the next input source.



Name	Function
② [Enter] button [↵]	Enters the current selection and moves to the next level while displaying the projector's menu or help. Optimizes Tracking , Sync. , and Position in the projector's Signal menu while projecting an analog RGB signal from the Computer port. From now on, referred to as the [Enter] button.
③ Keystone adjustment buttons and arrow buttons	Displays the Keystone screen allowing you to correct keystone distortion. Selects menu items while displaying the projector's menu or help.
④ [Esc] button	Stops the current function. Moves back to the previous menu level while displaying the projector's menu.
⑤ Volume buttons and arrow buttons Wide/Tele buttons	<ul style="list-style-type: none"> • EB-U32/EB-W32/EB-W31/EB-X36/EB-X31/EB-U04/EB-W04/EB-X04/EB-U130/EB-W130/EB-X130/EB-X350/EB-X300:  : Decreases the volume.  : Increases the volume. • EB-S31/EB-S04/EB-S130/EB-S300:  : Enlarges the size of the projected image.  : Reduces the size of the projected image. Corrects keystone distortion in the horizontal direction when the Keystone screen is displayed. Selects menu items while displaying the projector's menu or help.
⑥ [Menu] button	Displays and closes the projector's menu.
⑦ [Home] button	Displays and closes the Home screen.
⑧ Power button [⏻]	Turns the projector on or off. From now on, referred to as the power button.
⑨ Indicators	Indicates the projector's status.

» **Related Links**

- "Home Screen" [p.34](#)
- "Input Signal Settings - Signal Menu" [p.103](#)
- "Projector Indicators Status" [p.135](#)
- "Correcting the Image Shape with the Keystone Buttons" [p.42](#)

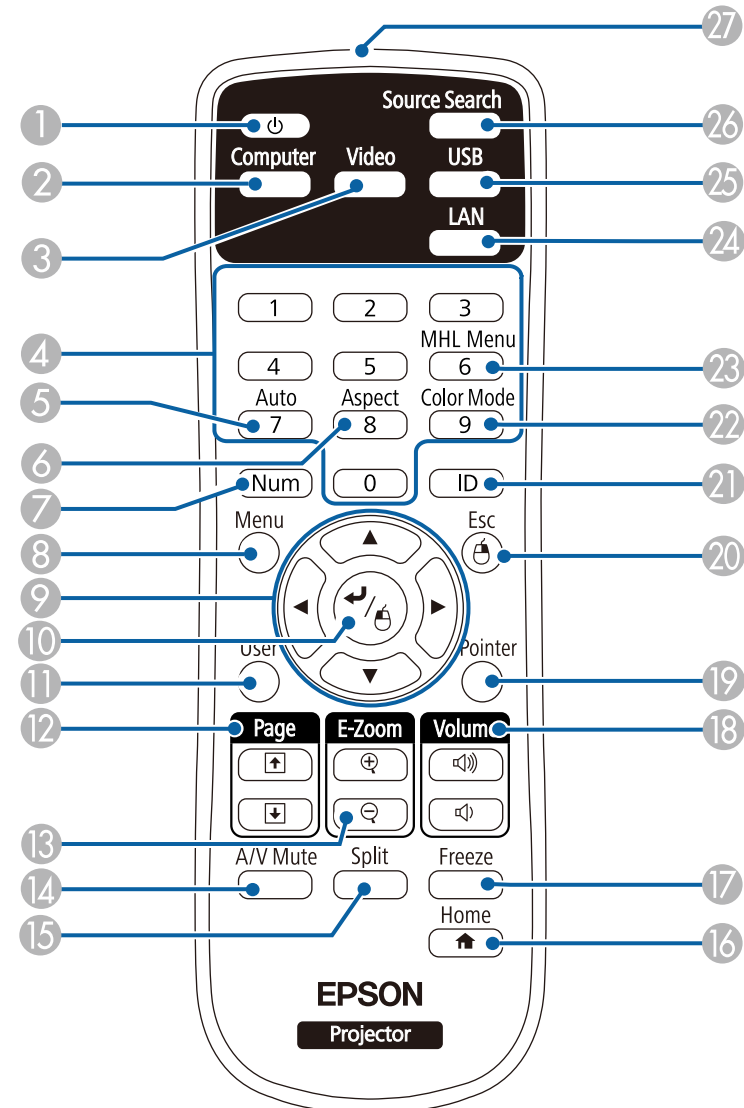
Projector Parts - Remote Control



Name	Function
① Power button []	Turns the projector on or off. From now on, referred to as the power button.
② [Computer] button	Selects the Computer port as the image source.
③ [Video] button	Switches the image source between the S-Video, Video and HDMI port.
④ Numeric buttons	Enters numbers in the projector's menu while holding down the [Num] button.
⑤ [Auto] button	Optimizes Tracking , Sync. , and Position in the projector's Signal menu while projecting an analog RGB signal from the Computer port.
⑥ [Aspect] button	Changes the aspect mode.
⑦ [Num] button	Hold down this button to enter numbers using the numeric buttons.
⑧ [Menu] button	Displays and closes the projector's menu.
⑨ Arrow buttons	Selects menu items while displaying the projector's menu or help.
⑩ [Enter] button []	Enters the current selection and moves to the next level while displaying the projector's menu or help. Acts as a mouse's left button when using the Wireless Mouse function. From now on, referred to as the [Enter] button.
⑪ [User] button	Performs settings assigned in the User Button setting in the projector's Settings menu.
⑫ [Page] up/down buttons	Controls page up and down on your computer when you connect a projector and computer using a USB cable or over a network. Displays the previous or next screen while using the PC Free feature.
⑬ [E-Zoom +/-] buttons	Zooms in or zooms out the image area.
⑭ [A/V Mute] button	Turns the video and audio on or off temporarily.
⑮ [Split] button	Projects two images from different image sources simultaneously by splitting the projected screen.

Name	Function
⑯ [Home] button	Displays and closes the Home screen.
⑰ [Freeze] button	Pauses or resumes images.
⑱ [Volume] up/down buttons	Adjusts the speaker volume.
⑲ [Pointer] button	Displays the on-screen pointer.
⑳ [Esc] button	Stops the current function. Moves back to the previous menu level while displaying the projector's menu. Acts as a mouse's right button when using the Wireless Mouse function.
㉑ [ID] button	Hold down this button and press the numeric buttons to select the ID for the projector you want to operate using the remote control.
㉒ [Color Mode] button	Changes the color mode.
㉓ [MHL Menu] button	Displays the settings menu for the device linked to the projector's HDMI/MHL port.
㉔ [LAN] button	Switches the image source between the network connected devices.
㉕ [USB] button	Switches the image source between the USB Display and USB-A port.
㉖ [Source Search] button	Changes to the next input source.
㉗ Remote control light emitting area	Outputs remote control signals.

» **Related Links**

- "Image Aspect Ratio" [p.51](#)
- "Color Mode" [p.53](#)
- "Input Signal Settings - Signal Menu" [p.103](#)
- "Projector Setup Settings - Extended Menu" [p.107](#)
- "Projecting Two Images Simultaneously" [p.57](#)
- "Using the Remote Control as a Wireless Mouse" [p.68](#)
- "Using the Remote Control as a Pointer" [p.70](#)

- "Connecting to a Computer" [p.21](#)
- "Projecting a PC Free Presentation" [p.60](#)
- "Using the Projector on a Network" [p.81](#)

Setting Up the Projector

Follow the instructions in these sections to set up your projector.

► Related Links

- "Projector Placement" [p.19](#)
- "Projector Connections" [p.21](#)
- "Installing Batteries in the Remote Control" [p.29](#)
- "Remote Control Operation" [p.30](#)
- "Opening the Lens Cover" [p.31](#)

You can place the projector on almost any flat surface to project an image.

You can also install the projector in a ceiling mount if you want to use it in a fixed location. An optional ceiling mount is required when suspending the projector from a ceiling.

Note the following points when selecting a projector location:

- Place the projector on a sturdy, level surface or install it using a compatible mount.

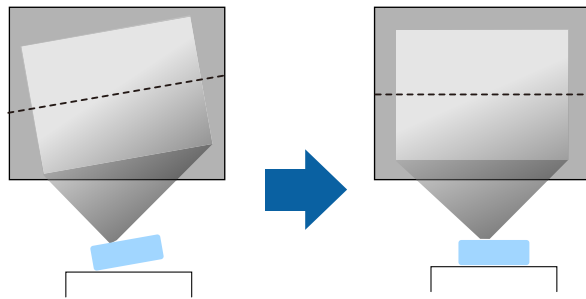

- Leave plenty of space around and under the projector for ventilation, and do not place it on top of or next to anything that could block the vents.
- Position the projector within reach of a grounded electrical outlet or extension cord.
- Place the projector parallel to the screen.

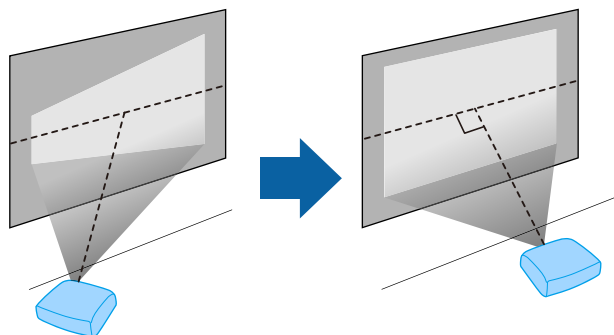

If you cannot install the projector parallel to the screen, correct keystone distortion using the projector controls.

Warning

- You must install a ceiling mount when suspending the projector from a ceiling. If you do not install the projector correctly, it could fall and cause damage or injury.
- Do not use adhesives on the ceiling mount fixing points to prevent the screws from loosening, or use lubricants, oils, or similar substances on the projector; the projector case may crack causing it to fall from its ceiling mount. This could cause serious injury to anyone under the ceiling mount and could damage the projector.
- Do not cover the projector's air intake or air exhaust vents. If the vents are covered, the internal temperature could rise and cause a fire.

Attention

- Do not operate the projector on its side. This may cause the projector to malfunction.
- If you are using the projector at altitudes above 1500 m, set the **High Altitude Mode** setting to **On** in the projector's **Extended** menu to ensure the projector's internal temperature is regulated properly.
 - ☛ **Extended > Operation > High Altitude Mode**

» Related Links

- "Projector Setup and Installation Options" [p.19](#)
- "Projection Distance" [p.20](#)
- "Image Shape" [p.41](#)
- "Projector Setup Settings - Extended Menu" [p.107](#)
- "Optional Accessories" [p.148](#)

Projector Setup and Installation Options

You can set up or install your projector in the following ways:

Front/Rear

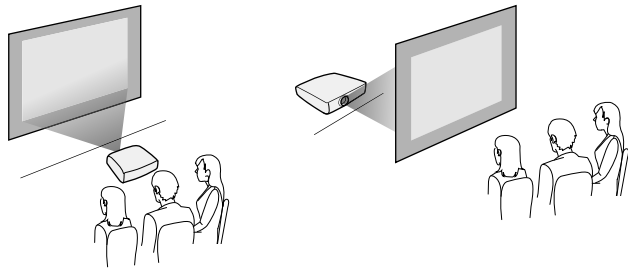

Front Ceiling/Rear Ceiling

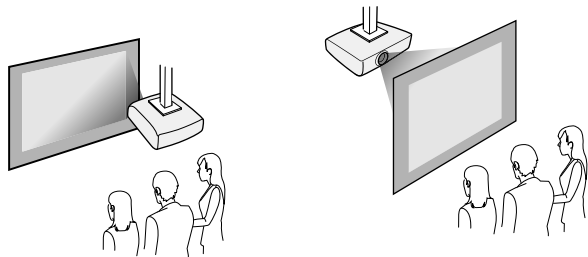

When projecting from the ceiling or from the rear, make sure you select the correct **Projection** option in the projector's **Extended** menu.

» Related Links

- "Projection Modes" [p.38](#)



When correcting keystone distortion, your image is slightly smaller.

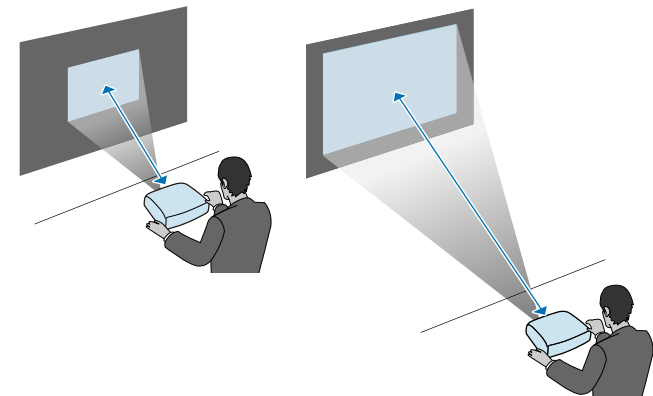

» Related Links

- "Screen Size and Projection Distance" [p.149](#)

Projection Distance

The distance at which you place the projector from the screen determines the approximate size of the image. The image size increases the farther the projector is from the screen, but can vary depending on the zoom factor, aspect ratio, and other settings.

See the Appendix for details about how far to place the projector from the screen based on the size of the projected image.

You can connect the projector to a variety of computer, video, and audio sources to display presentations, movies, or other images, with or without sound.

Illustrations in this section are of EB-W04.

- Connect a computer that has a USB port, standard video output (monitor) port, or HDMI port.
- For video projection, connect devices such as DVD players, gaming consoles, digital cameras, and smartphones with compatible video output ports.
- If your presentation or video includes sound, you can connect audio input cables.
- For slide shows or presentations without a computer, you can connect USB devices (such as a flash drive or camera) or the optional Epson document camera.

▶ Related Links

- "Connecting to a Computer" [p.21](#)
- "Connecting to Smartphones or Tablets" [p.23](#)
- "Connecting to Video Sources" [p.24](#)
- "Connecting to External USB Devices" [p.27](#)
- "Connecting to a Document Camera" [p.28](#)

Connecting to a Computer

Follow the instructions in these sections to connect a computer to the projector.

▶ Related Links

- "Connecting to a Computer for VGA Video and Audio" [p.21](#)
- "Connecting to a Computer for USB Video and Audio" [p.22](#)
- "Connecting to a Computer for HDMI Video and Audio" [p.23](#)

Connecting to a Computer for VGA Video and Audio

You can connect the projector to your computer using a VGA computer cable. The VGA computer cable may not be included with your projector.

You can play sound through the projector's speaker system by connecting a commercially available RCA audio cable.



To connect a Mac that includes only a Mini DisplayPort, Thunderbolt port, or Mini-DVI port for video output, you need to obtain an adapter that allows you to connect to the projector's VGA video port. Contact Apple for compatible adapter options.

- 1** Connect the VGA computer cable to your computer's monitor port.
- 2** Connect the other end to a Computer port on the projector.

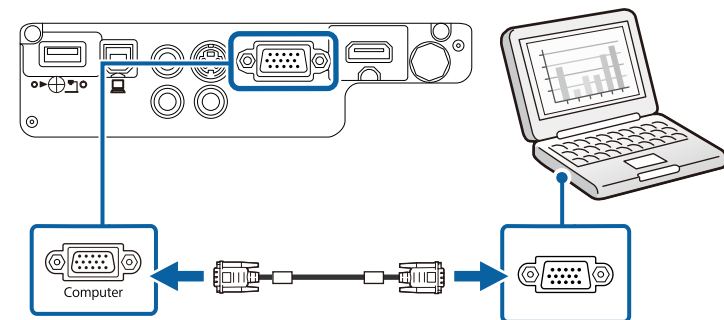

- 3** Tighten the screws on the VGA connector.
- 4** Connect the audio cable to your laptop's headphone or audio-out jack, or your desktop's speaker or audio-out port.

5 Connect the other end to the projector's Audio ports.

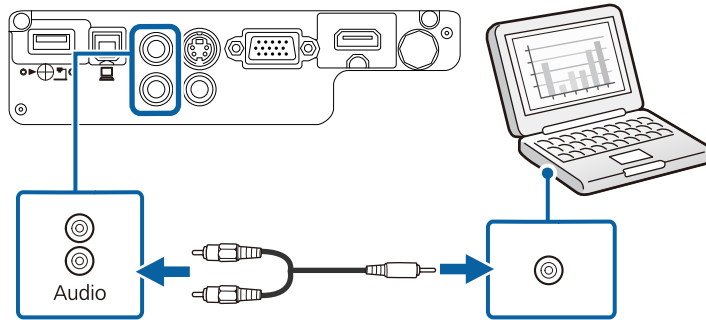

Connecting to a Computer for USB Video and Audio

If your computer meets the system requirements, you can send video and audio output to the projector through the computer's USB port. This function is called USB Display. The USB cable may not be included with your projector.



If you use a USB hub, the connection may not operate correctly. Connect the USB cable directly to the projector.

1 Connect the cable to your projector's USB-B port.

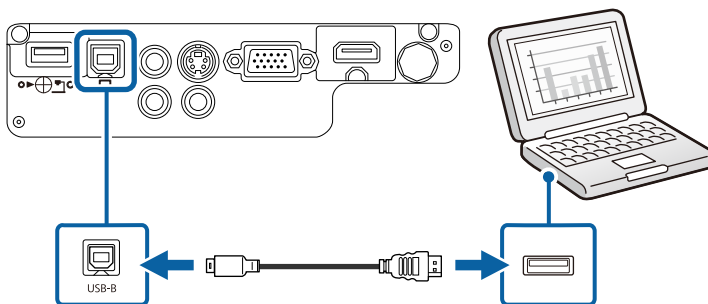

2 Connect the other end to any available USB port on your computer.

3 Turn on the projector.

4 Do one of the following to install the Epson USB Display software:



You only need to install this software the first time you connect the projector to the computer.

- Windows 2000: Double-click **Computer** > **EPSON_PJ_UD** > **EMP_UDSE.EXE**.
- Windows XP: Wait as messages are displayed on your computer screen and the projector installs the Epson USB Display software on your computer. If it is not installed automatically, double-click **My Computer** > **EPSON_PJ_UD** > **EMP_UDSE.EXE**.
- Windows Vista/Windows 7/Windows 8/Windows 8.1: Select **Run EMP_UDSE.EXE** in the dialog box that is displayed to install the Epson USB Display software.
- OS X: The Epson USB Display setup folder is displayed on your screen. Select **USB Display Installer** and follow the on-screen instructions to install the Epson USB Display software. If the USB Display **Setup** folder is not displayed automatically, double-click **EPSON_PJ_UD** > **USB Display Installer**.

5 Follow any on-screen instructions.

Do not disconnect the USB cable or turn off the projector until the projector displays an image.



If you are using Windows 2000 or Windows XP and you see a message asking if you want to restart your computer, select **No**.

The projector displays the image from your computer's desktop and outputs sound if your presentation contains audio.



- If the projector does not project any images, do one of the following:
 - Windows: Click **All Programs > EPSON Projector > Epson USB Display > Epson USB Display Ver.x.xx**.
 - OS X: Double-click the **USB Display** icon in the **Application** folder.
- When you finish projection, do one of the following:
 - **Windows:** Disconnect the USB cable. You do not need to operate **Safely Remove Hardware**.
 - OS X: Select **Disconnect** from the **USB Display** icon menu on the menu bar or **Dock**, and then disconnect the USB cable.

» Related Links

- "USB Display System Requirements" [p.159](#)

Connecting to a Computer for HDMI Video and Audio

If your computer has an HDMI port, you can connect it to the projector using a commercially available HDMI cable and send the computer's audio with the projected image.



To connect a Mac that includes only a Mini DisplayPort, Thunderbolt port, or Mini-DVI port for video output, you need to obtain an adapter that allows you to connect to the projector's HDMI port. Contact Apple for compatible adapter options. Older Mac computers (2009 and earlier) may not support audio through the HDMI port.

- 1** Connect the HDMI cable to your computer's HDMI output port.

- 2** Connect the other end to the projector's HDMI port.

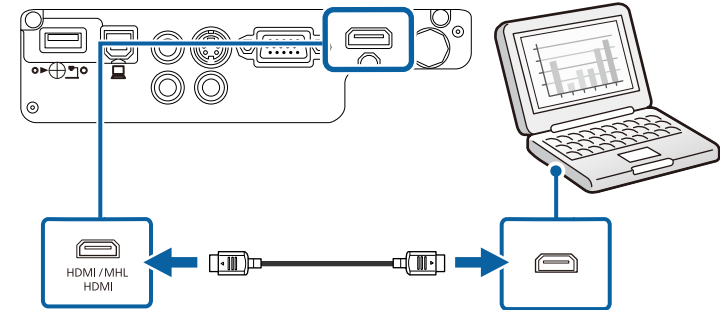

» Related Links

- "Projector Setup Settings - Extended Menu" [p.107](#)

Connecting to Smartphones or Tablets

You can connect the projector to smartphones and tablets using a commercially available MHL cable and send the audio with the projected image (EB-U32/EB-W32/EB-W31/EB-U04/EB-U130).



- You may not be able to connect an MHL cable to all devices.
- You may not be able to project correctly, depending on the model and settings of the smartphone or tablet.
- To check if your smartphone or tablet device supports MHL, contact the manufacturer of your smartphone or tablet device.

- 1** Connect the MHL cable to your device's MHL port.

- 2** Connect the other end to the projector's HDMI/MHL port.

EB-W32/EB-W31

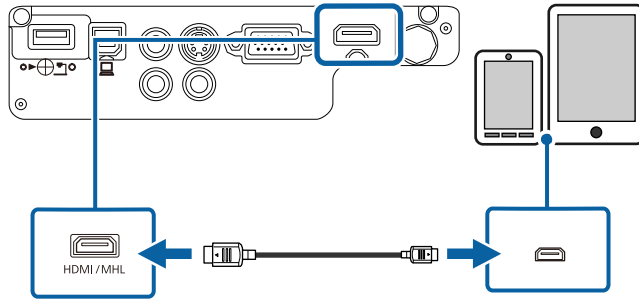

EB-U32/EB-U04/EB-U130

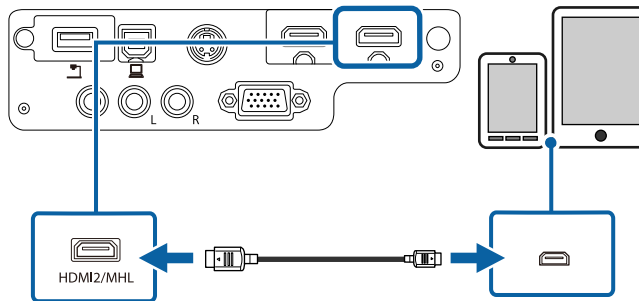

Attention

If you connect an MHL cable that does not support the MHL standard, the smartphone or tablet device may become hot, or leakage or explosion may happen.

The connected smartphone or tablet begins charging when images are projected. If you connect using a commercially available MHL-HDMI conversion adapter, charging the smartphone or tablet device may not work or you may not be able to perform operations using the projector's remote control.



If images are not projected correctly, disconnect and then reconnect the MHL cable.

Connecting to Video Sources

Follow the instructions in these sections to connect video devices to the projector.

Attention

Check the shape and orientation of the connectors on any cable you plan to connect. Do not force a connector into a port if it does not fit. The device or your projector could be damaged or could malfunction.



If the port on the device you connect has an unusual shape, use the cable supplied with the device or an optional cable to connect to the projector.

» **Related Links**

- "Connecting to an HDMI Video Source" [p.24](#)
- "Connecting to a Component-to-VGA Video Source" [p.25](#)
- "Connecting to an S-Video Video Source" [p.26](#)
- "Connecting to a Composite Video Source" [p.26](#)

Connecting to an HDMI Video Source

If your video source has an HDMI port, you can connect it to the projector using a commercially available HDMI cable and send the image source's audio with the projected image.

Attention

Do not turn on the video source before connecting it to the projector. Doing so could damage the projector.



1 Connect the HDMI cable to your video source's HDMI output port.

2 Connect the other end to the projector's HDMI port.

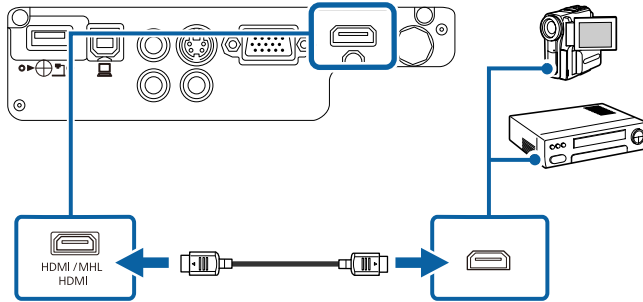

► **Related Links**

- "Projector Setup Settings - Extended Menu" [p.107](#)

Connecting to a Component-to-VGA Video Source

If your video source has component video ports, you can connect it to the projector using an optional component-to-VGA video cable. Depending on your component ports, you may need to use an adapter cable along with a component video cable.

You can play sound through the projector's speaker system by connecting a commercially available RCA audio cable.

 Make sure the audio cable is labeled "No resistance".

1 Connect the component connectors to your video source's color-coded component video output ports.

 The ports usually labeled Y, Pb, Pr or Y, Cb, Cr. If you are using an adapter, connect these connectors to your component video cable.

2 Connect the VGA connector to a Computer port on the projector.

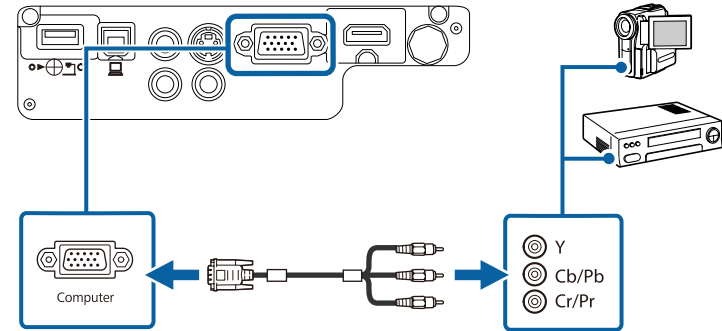

3 Tighten the screws on the VGA connector.

4 Connect the audio cable to your video source's audio-out ports.

5 Connect the other end to the projector's Audio ports.

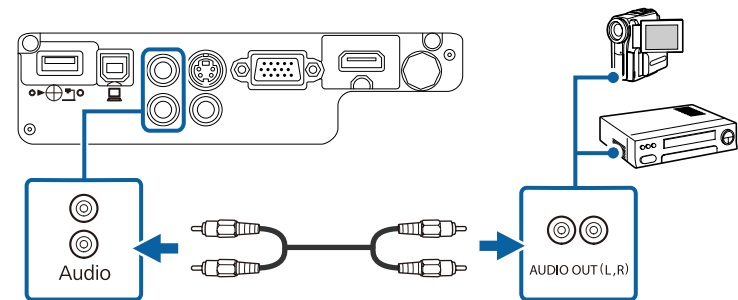

If your image colors appear incorrectly, you may need to change the **Input Signal** setting in the projector's **Signal** menu.

☛ **Signal > Advanced > Input Signal**

► **Related Links**

- "Input Signal Settings - Signal Menu" [p.103](#)

Connecting to an S-Video Video Source

If your video source has an S-Video port, you can connect it to the projector using a commercially available S-Video cable (EB-W32/EB-W31/EB-X36/EB-X31/EB-S31/EB-W04/EB-X04/EB-S04/EB-W130/EB-X130/EB-S130/EB-X350/EB-X300/EB-S300).

You can play sound through the projector's speaker system by connecting a commercially available RCA audio cable.



Make sure the audio cable is labeled "No resistance".

- 1** Connect the S-Video cable to your video source's S-Video output port.
- 2** Connect the other end to the projector's S-Video port.

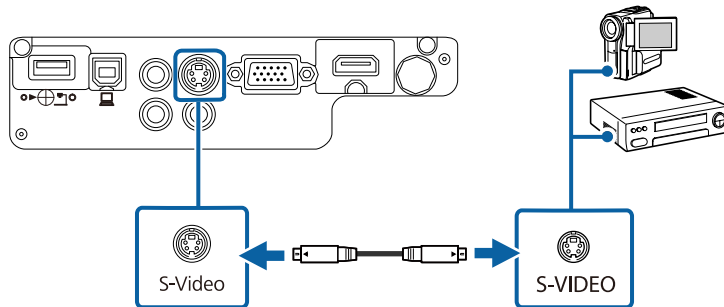

- 3** Connect the audio cable to your video source's audio-out ports.

- 4** Connect the other end to the projector's Audio ports.

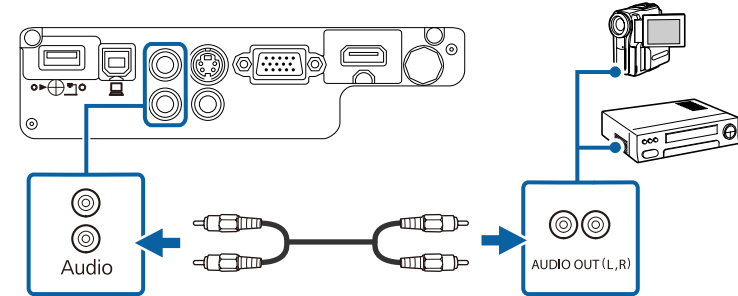

Connecting to a Composite Video Source

If your video source has a composite video port, you can connect it to the projector using a commercially available RCA-style video or A/V cable.

You can play sound through the projector's speaker system by connecting a commercially available RCA audio cable.



Make sure the audio cable is labeled "No resistance".

- 1** Connect the cable with the yellow connector to your video source's yellow video output port.
- 2** Connect the other end to the projector's Video port.

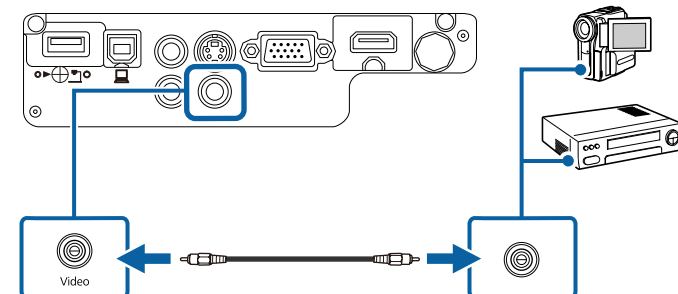

3 Connect the audio cable to your video source's audio-out ports.

4 Connect the other end to the projector's Audio ports.

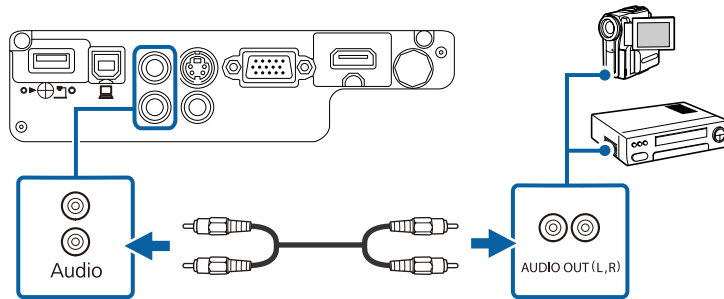

- Digital cameras or smartphones must be USB-mounted devices, not TWAIN-compliant devices, and must be USB Mass Storage Class-compliant.
- USB hard drives must meet these requirements:
 - USB Mass Storage Class-compliant (not all USB Mass Storage Class devices are supported)
 - Formatted in FAT or FAT32
 - Self-powered by their own AC power supplies (bus-powered hard drives are not recommended)
 - Avoid using hard drives with multiple partitions

You can project image files on a connected USB device using PC Free.

» **Related Links**

- "Projecting a PC Free Presentation" [p.60](#)

Connecting to External USB Devices

Follow the instructions in these sections to connect external USB devices to the projector.

» **Related Links**

- "USB Device Projection" [p.27](#)
- "Connecting to a USB Device" [p.27](#)
- "Disconnecting a USB Device" [p.28](#)

USB Device Projection

You can project images and other content without using a computer or video device by connecting any of these devices to your projector:

- USB flash drive
- Digital camera or smartphone
- USB hard drive
- Multimedia storage viewer

Connecting to a USB Device

You can connect your USB device to the projector's USB-A port and use it to project images and other content.

1 If your USB device came with a power adapter, plug the device into an electrical outlet.

2 Connect the USB cable (or USB flash drive or USB memory card reader) to the projector's USB-A port shown here.

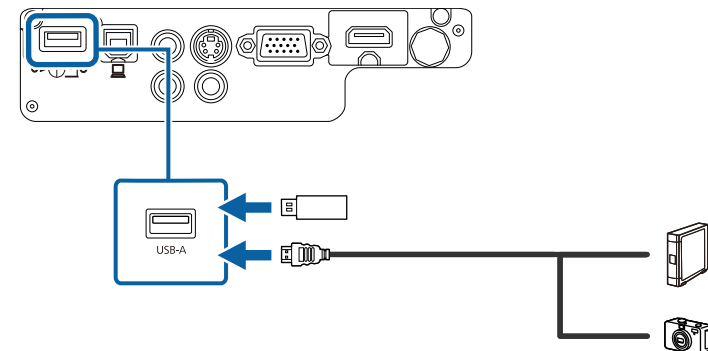

Attention

- Use the USB cable supplied with or specified for use with the device.
- Do not connect a USB hub or a USB cable longer than 3 meters, or the device may not operate correctly.

- 3** Connect the other end to your device, if necessary.

Disconnecting a USB Device

When you have finished presenting with a connected USB device, disconnect the device from the projector.

- 1** Turn off and unplug the device, if necessary.
- 2** Disconnect the USB device from the projector.

Connecting to a Document Camera

You can connect a document camera to your projector to project images viewed by the camera.

The connection method varies depending on your Epson document camera model. See the document camera manual for details.

The remote control uses the two AA batteries that came with the projector.

Attention

Make sure you read the *Safety Instructions* before handling the batteries.

- 1 Open the battery cover as shown.

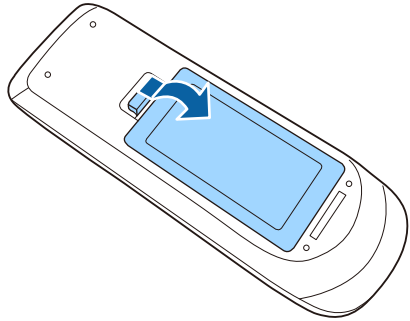

- 2 Insert the batteries with the + and - ends facing as shown.

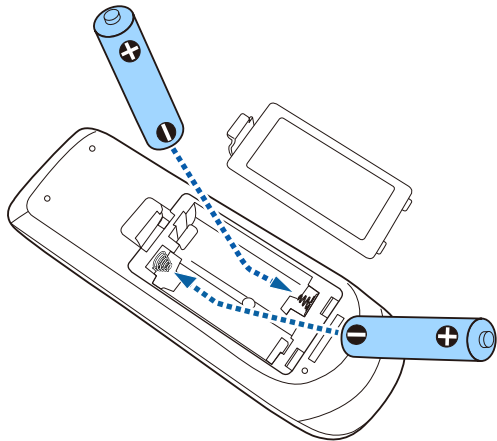

Warning

Check the positions of the (+) and (-) marks inside the battery holder to ensure the batteries are inserted the correct way. If the batteries are not used correctly, they could explode or leak causing a fire, injury, or damage to the product.

- 3 Close the battery cover and press it down until it clicks into place.

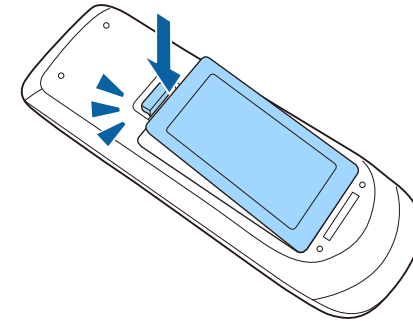

The remote control lets you control the projector from almost anywhere in the room.

Make sure that you aim the remote control at the projector's receivers within the distance and angles listed here.

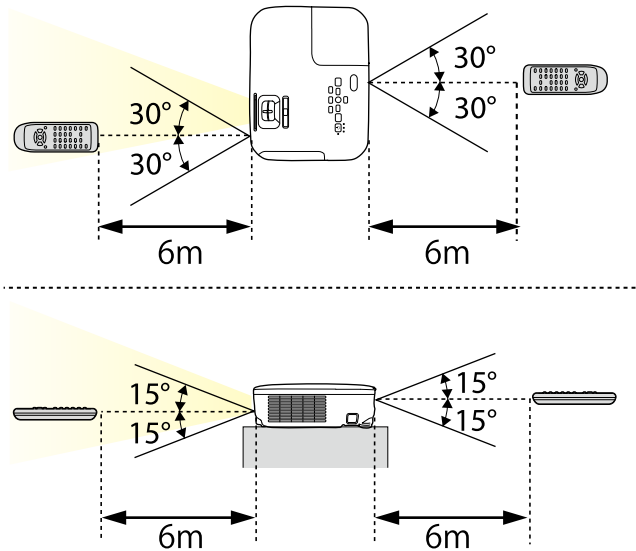

Avoid using the remote control in conditions with bright fluorescent lights or in direct sunlight, or the projector may not respond to commands. If you are not going to use the remote control for a long time, remove the batteries.

- 1** To open the projector's lens cover, slide the A/V Mute slide lever until it clicks.

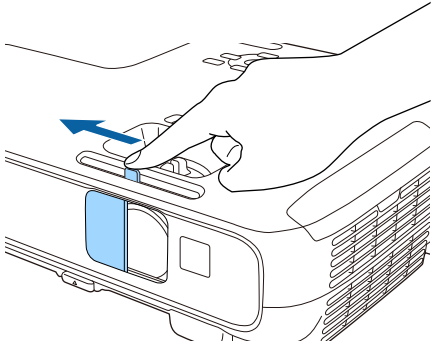

- 2** To cover the lens or temporarily turn off the projected image and sound, close the lens cover.

Using Basic Projector Features

Follow the instructions in these sections to use your projector's basic features.

► Related Links

- "Turning On the Projector" [p.33](#)
- "Turning Off the Projector" [p.36](#)
- "Selecting the Language for the Projector Menus" [p.37](#)
- "Projection Modes" [p.38](#)
- "Adjusting the Image Height" [p.40](#)
- "Image Shape" [p.41](#)
- "Resizing the Image with the Zoom Ring" [p.46](#)
- "Resizing the Image with the Buttons" [p.47](#)
- "Focusing the Image Using the Focus Ring" [p.48](#)
- "Selecting an Image Source" [p.49](#)
- "Image Aspect Ratio" [p.51](#)
- "Color Mode" [p.53](#)
- "Controlling the Volume with the Volume Buttons" [p.55](#)

Turn on the computer or video equipment you want to use after you turn on the projector.

- 1** Connect the power cord to the projector's power inlet and plug it into an electrical outlet.

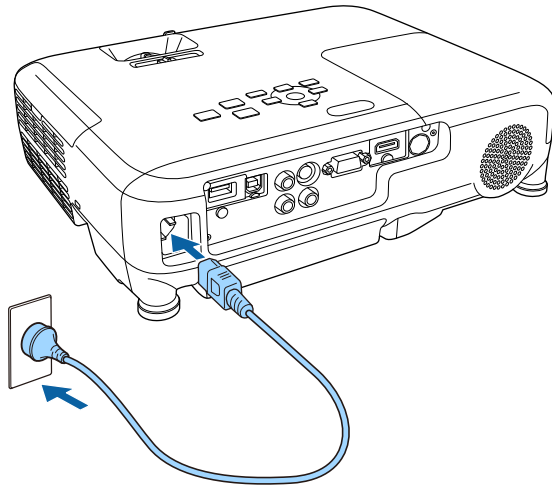

The projector's power indicator turns blue. This indicates that the projector is receiving power, but is not yet turned on (it is in standby mode).

- 2** Press the power button on the control panel or remote control to turn on the projector.

The projector beeps and the status indicator flashes blue as the projector warms up. Once the projector is warmed up, the status indicator stops flashing and turns blue.

- 3** Open the projector's lens cover.

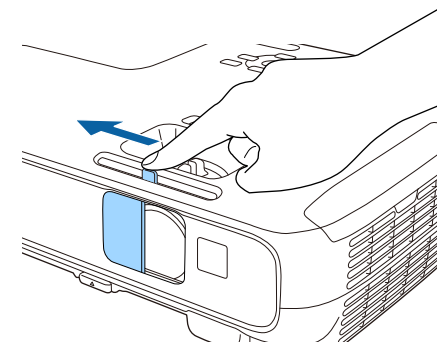

Try the following if you do not see a projected image.

- Verify the lens cover is open all the way.
- Turn on the connected computer or video device.
- Change the screen output from the computer when using a laptop computer.
- Insert a DVD or other video media, and press play (if necessary).
- Press the [Source Search] button on the control panel or remote control to detect the source.
- Press the button for the desired video source on the remote control.
- If the Home screen is displayed, select the source you want to project.

⚠ Warning

- Never look into the projector lens when the lamp is on. This can damage your eyes and is especially dangerous for children.
 - During projection, do not block the light from the projector with a book or other objects. If the light from the projector is blocked, the area on which the light shines becomes hot which could cause it to melt, burn, or start a fire. Also, the lens may get hot due to the reflected light which could cause the projector to malfunction. To stop projection, use the A/V Mute function, or turn off the projector.
 - A mercury lamp with high internal pressure is used as the projector's light source. If the lamp is subjected to vibrations or shocks, or if it is used for an overly extended length of time, the lamp may break or it may not turn on. If the lamp explodes, gases may escape and small fragments of glass may be scattered which could cause an injury. Be sure to observe the instructions below.
 - Do not disassemble or damage the lamp or subject it to any impacts.
 - Do not bring your face close to the projector while it is in use.
 - Particular care should be taken when the projector is installed to a ceiling, as small pieces of glass may fall down when the lamp cover is removed. When cleaning the projector or replacing the lamp yourself, be very careful not to allow such pieces of glass to get into the eyes or mouth.
- If the lamp breaks, ventilate the area immediately, and contact a doctor if any fragments of broken glass are inhaled or get into the eyes or mouth.



- When the **Direct Power On** setting is set to **On** in the projector's **Extended** menu, the projector turns on as soon as you plug it in. Note that the projector also turns on automatically in cases such as recovery from a power outage.
 - ☛ **Extended > Operation > Direct Power On**
- If you select a specific port as the **Auto Power On** setting in the projector's **Extended** menu, the projector turns on as soon as it detects a signal or cable connection from that port. (Set **Standby Mode** to **Communication On** in the projector's **ECO** menu first.)
 - ☛ **Extended > Operation > Auto Power On**

» Related Links

- "Home Screen" p.34
- "Projector Setup Settings - Extended Menu" p.107

- "Projector Setup Settings - ECO Menu" p.115

Home Screen

The Home screen feature allows you to easily select an image source and access useful functions. You can display the Home screen by pressing the [Home] button on the control panel or remote control. The Home screen is also displayed when you turn on the projector and no signal is being input from the selected input source.

Press the arrow buttons on the control panel or remote control to select a menu item, and then press [Enter].

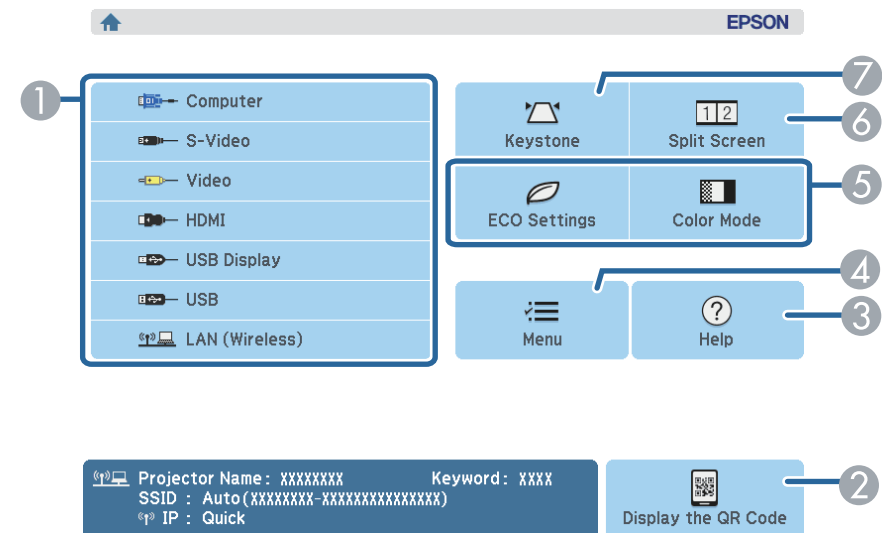

①	Select the source you want to project.
②	Displays the QR code and projects data on a smartphone or tablet device.
③	Displays the Help screen.
④	Displays the projector's menu.
⑤	Performs menu options assigned to Home Screen setting in the projector's Extended menu.

- | | |
|---|--|
| 6 | Projects two images from different image sources simultaneously by splitting the projected screen. |
| 7 | Corrects the shape of an image that is an uneven rectangle. |



The Home screen disappears after 10 minutes of inactivity.

► Related Links

- "Image Shape" [p.41](#)
- "Projector Setup Settings - Extended Menu" [p.107](#)
- "Using a QR Code to Connect a Mobile Device" [p.87](#)
- "Using the Projector's Menus" [p.99](#)
- "Using the Projector Help Displays" [p.137](#)
- "Connecting to a Computer" [p.21](#)

Turn off the projector after use.



Turn off this product when it is not in use to prolong the life of the projector. Lamp life varies depending on the mode selected, environmental conditions, and usage. Brightness decreases over time.

- 1** Press the power button on the control panel or remote control.
The projector displays a shutdown confirmation screen.

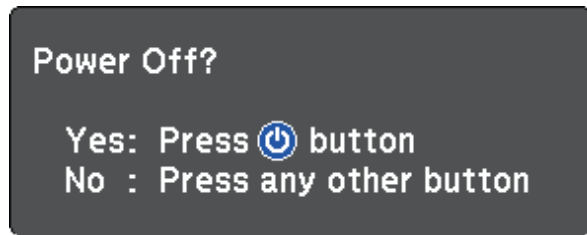

- 2** Press the power button again. (To leave it on, press any other button.)
The projector beeps twice, the lamp turns off, and the status indicator turns off.



With Epson's Instant Off technology, there is no cool-down period so you can pack up the projector for transport right away.

- 3** To transport or store the projector, make sure the power indicator is blue (but not flashing) and the status indicator is off, then unplug the power cord.

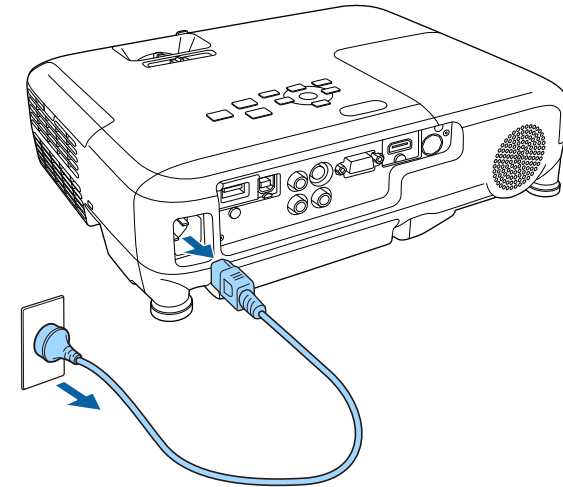

- 4** Close the projector's lens cover.

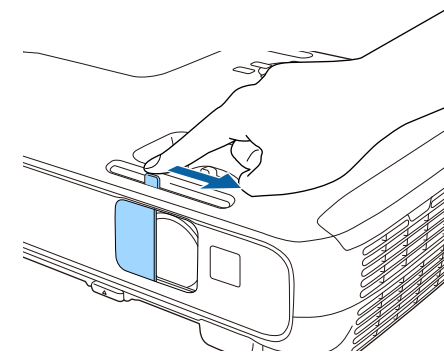

If you want to view the projector's menus and messages in another language, you can change the **Language** setting.

- 1 Turn on the projector.
- 2 Press the [Menu] button on the control panel or remote control.

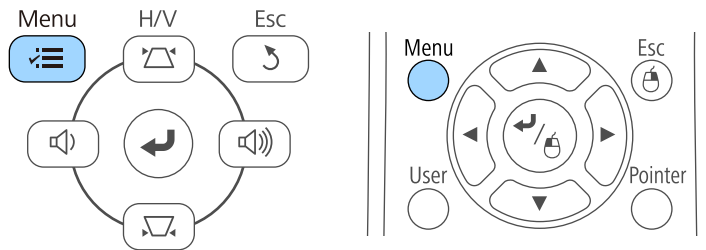

- 6 Press [Menu] or [Esc] to exit the menus.

- 3 Select the **Extended** menu and press [Enter].

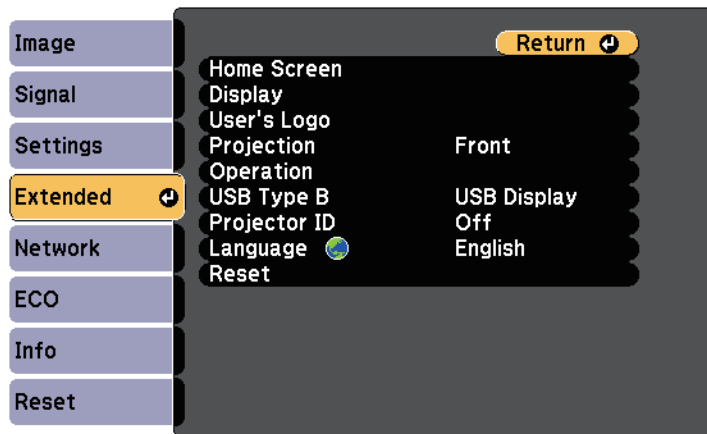

- 4 Select the **Language** setting and press [Enter].
- 5 Select the language you want to use and press [Enter].

Depending on how you positioned the projector, you may need to change the projection mode so your images project correctly.

- **Front** (default setting) lets you project from a table in front of the screen.
- **Front/Ceiling** flips the image over top-to-bottom to project upside-down from a ceiling or wall mount.
- **Rear** flips the image horizontally to project from behind a translucent screen.
- **Rear/Ceiling** flips the image over top-to-bottom and horizontally to project from the ceiling and behind a translucent screen.

» **Related Links**

- "Changing the Projection Mode Using the Remote Control" [p.38](#)
- "Changing the Projection Mode Using the Menu" [p.38](#)
- "Projector Setup and Installation Options" [p.19](#)

Changing the Projection Mode Using the Remote Control

You can change the projection mode to flip the image over top-to-bottom.

- 1 Turn on the projector and display an image.
- 2 Hold down the [A/V Mute] button on the remote control for 5 seconds.

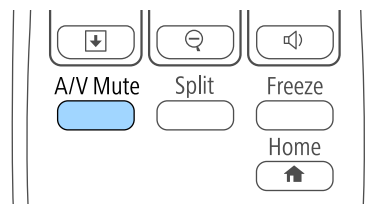

The image disappears briefly and reappears flipped top-to-bottom.

- 3 To change projection back to the original mode, hold down the [A/V Mute] button for 5 seconds again.

Changing the Projection Mode Using the Menu

You can change the projection mode to flip the image over top-to-bottom and/or left-to-right using the projector menus.

- 1 Turn on the projector and display an image.
- 2 Press the [Menu] button on the control panel or remote control.

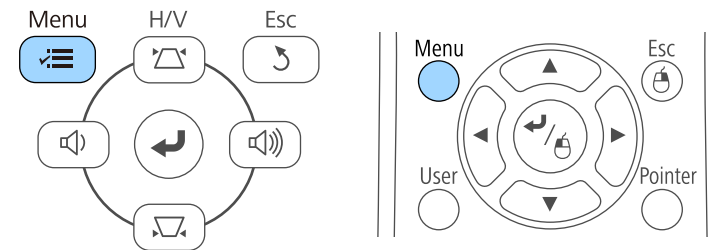

- 3 Select the **Extended** menu and press [Enter].

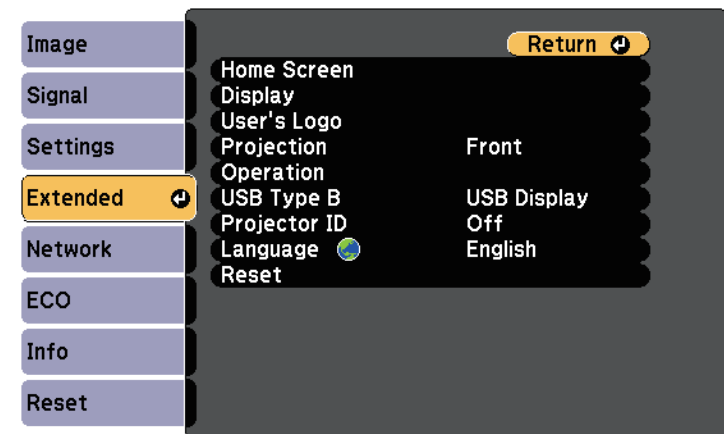

- 4 Select **Projection** setting and press [Enter].

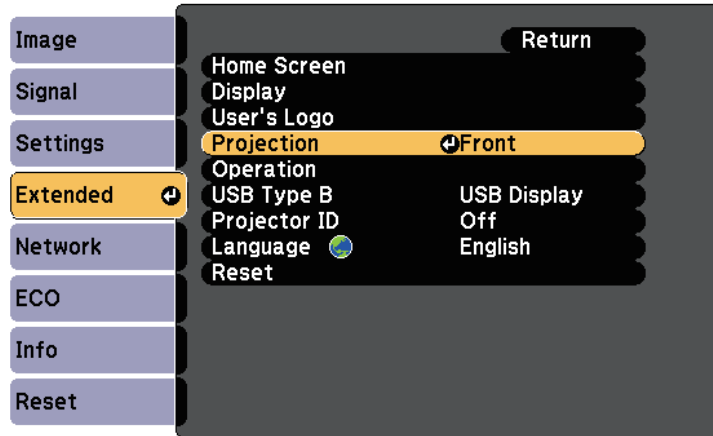

- 5 Select a projection mode and press [Enter].
- 6 Press [Menu] or [Esc] to exit the menus.

If you are projecting from a table or other flat surface and the image is too high or low, you can adjust the image height using the projector's adjustable feet. The larger the angle of tilt, the harder it becomes to focus. Locate the projector so that it only needs to be tilted at a small angle.

- 1** Turn on the projector and display an image.
- 2** To adjust the front foot, pull up on the foot release lever and lift the front of the projector.

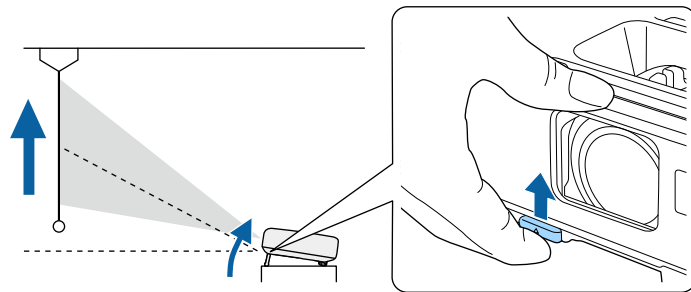

The foot extends from the projector. You can adjust the position up to 12 degrees.

- 3** Release the lever to lock the foot.
- 4** If the image is tilted, rotate the rear feet to adjust their height.

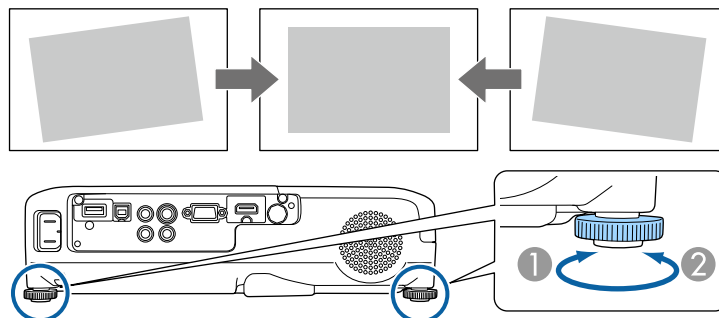

- 1** Extend the rear foot
- 2** Retract the rear foot

If the projected image is unevenly rectangular, you need to adjust the image shape.

► Related Links

- "Image Shape" [p.41](#)

You can project an even, rectangular image by placing the projector directly in front of the center of the screen and keeping it level. If you place the projector at an angle to the screen, or tilt it up or down, or off to the side, you may need to correct the image shape.

» Related Links

- "Auto V-Keystone" [p.41](#)
- "Correcting the Image Shape with the Horizontal Keystone Slider" [p.41](#)
- "Correcting the Image Shape with the Keystone Buttons" [p.42](#)
- "Correcting the Image Shape with Quick Corner" [p.43](#)

Auto V-Keystone

When the projector is moved or tilted, Auto V-Keystone automatically corrects any vertical keystone distortion.

When the projector is moved, it displays an adjustment screen and then automatically corrects the projected image.

Auto V-Keystone can correct the projected image distortion in these conditions:

- Projection angle is about 30° up or down
- The **Projection** setting is set to **Front** in the projector's **Extended** menu



If you do not want to use the Auto V-Keystone function, set **Auto V-Keystone** to **Off** in the projector's **Settings** menu.

☛ **Settings > Keystone > H/V-Keystone > Auto V-Keystone**

» Related Links

- "Projection Modes" [p.38](#)
- "Projector Feature Settings - Settings Menu" [p.105](#)
- "Projector Setup Settings - Extended Menu" [p.107](#)

Correcting the Image Shape with the Horizontal Keystone Slider

You can use the projector's horizontal keystone slider to correct the shape of an image that is an uneven horizontal rectangle, such as when the projector is placed to the side of the projection area.

- 1 Turn on the projector and display an image.
- 2 Adjust the slider until the image is an even rectangle.

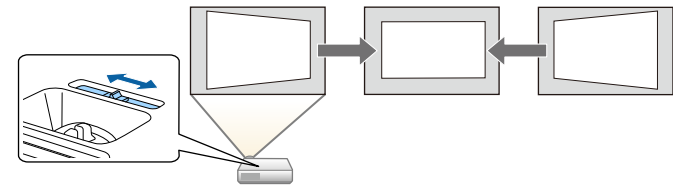

After correction, your image is slightly smaller.



- When you use the horizontal keystone slider, set **H-Keystone Adjuster** to **On** in the projector's **Settings** menu.
☛ **Settings > Keystone > H/V-Keystone > H-Keystone Adjuster**
- You can also correct the shape of the image in the horizontal direction by pressing the [Menu] button on the remote control and selecting **H/V-Keystone** in the projector's **Settings** menu.
☛ **Settings > Keystone > H/V-Keystone**

Correcting the Image Shape with the Keystone Buttons

You can use the projector's keystone correction buttons to correct the shape of an image that is unevenly rectangular.

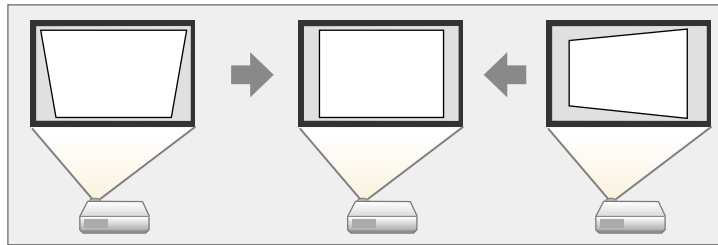

You can use keystone buttons to correct images up to 30° right, left, up, or down.

- 1** Turn on the projector and display an image.
- 2** Press one of the keystone adjustment buttons on the control panel to display the Keystone adjustment screen.

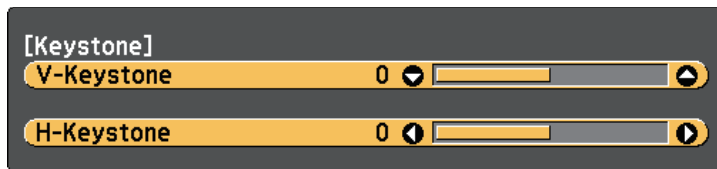

- 3** Press a keystone button to adjust the image shape.

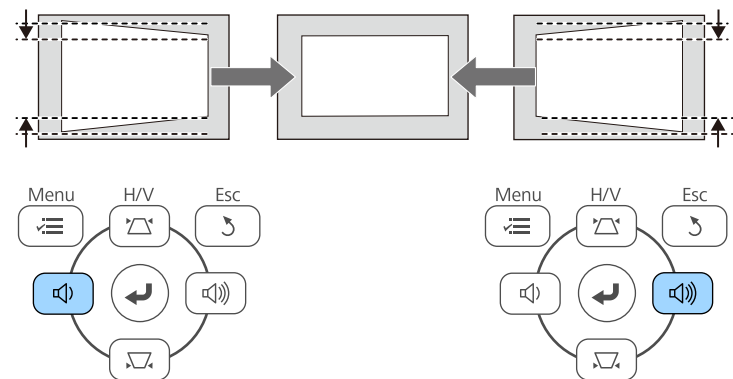
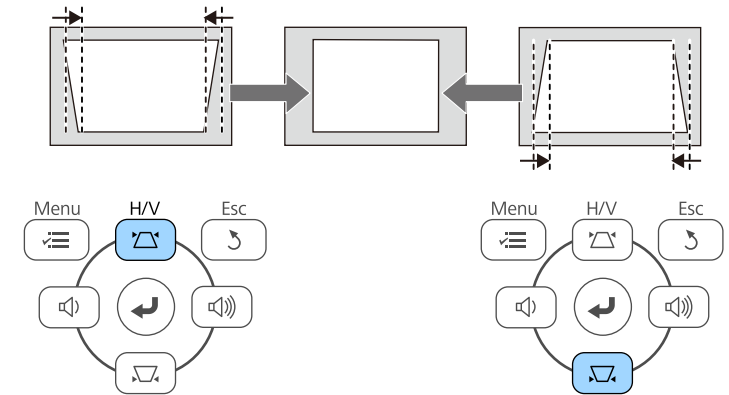

After correction, your image is slightly smaller.



If the projector is installed out of your reach, you can also correct the shape of the image by pressing the [Menu] button on the remote control and selecting **H/V-Keystone** in the projector's **Settings** menu.

Settings > Keystone > H/V-Keystone

» **Related Links**

- "Projector Feature Settings - Settings Menu" p.105

Correcting the Image Shape with Quick Corner

You can use the projector's Quick Corner setting to correct the shape and size of an image that is unevenly rectangular.

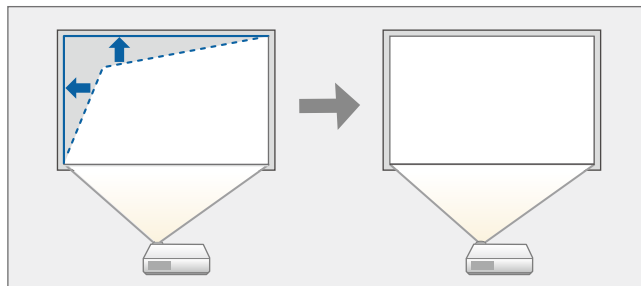

1 Turn on the projector and display an image.

2 Press the [Menu] button on the control panel or remote control.

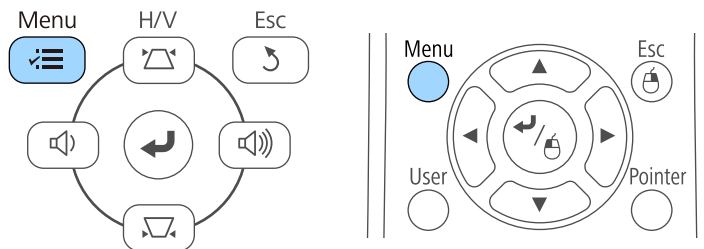

3 Select the **Settings** menu and press [Enter].

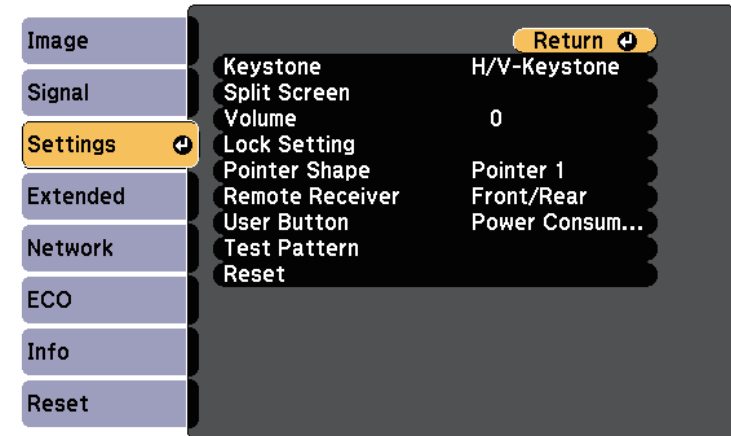

4 Select **Keystone** and press [Enter].

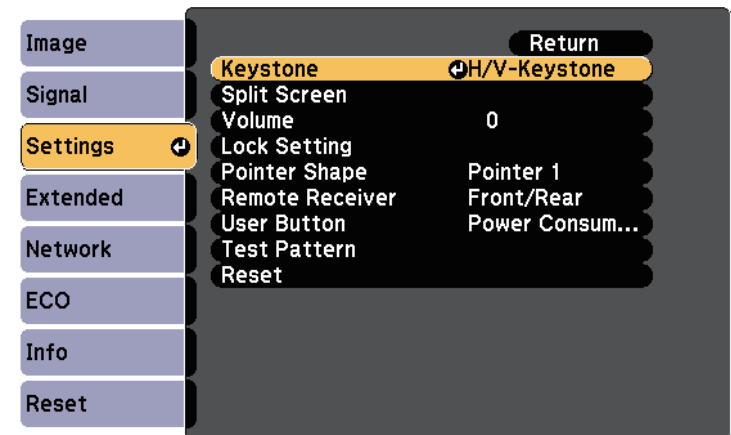

- 5** Select **Quick Corner** and press [Enter]. Press [Enter] again if necessary.



You see the Quick Corner adjustment screen.

- 6** Use the arrow buttons to select the corner of the image you want to adjust. Then press [Enter].

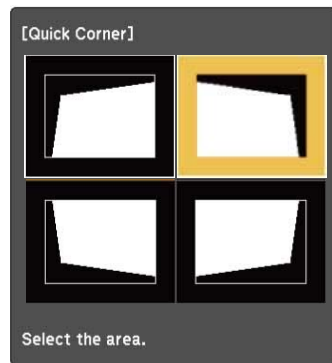

- 7** Press the arrow buttons to adjust the image shape as necessary. When you press [Enter], the Quick Corner adjustment screen is displayed.



- If you see this screen, you cannot adjust the shape any further in the direction indicated by the gray triangle.



- To reset the Quick Corner corrections, hold down [Esc] for about 2 seconds while the Quick Corner adjustment screen is displayed, and select **Reset Quick Corner**. Select **Switch to H/V-Keystone** to switch the image shape correction method to H/V-Keystone.

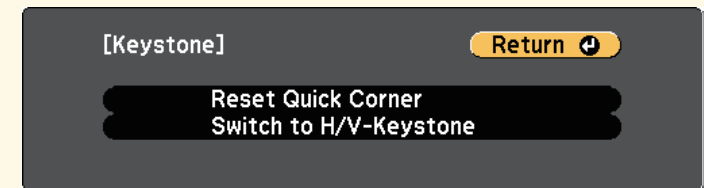

- 8** Repeat steps 6 and 7 as needed to adjust any remaining corners.
- 9** When you are finished, press [Esc].

The **Keystone** setting is now set to **Quick Corner** in the projector's **Settings** menu. The next time you press the keystone adjustment buttons on the control panel, the Quick Corner adjustment screen is displayed.

» Related Links

- "Projector Feature Settings - Settings Menu" [p.105](#)

You can resize the image using the projector's zoom ring (EB-U32/EB-W32/EB-W31/EB-X36/EB-X31/EB-U04/EB-W04/EB-X04/EB-U130/EB-W130/EB-X130/EB-X350/EB-X300).

- 1** Turn on the projector and display an image.
- 2** Rotate the zoom ring to enlarge or reduce the image.

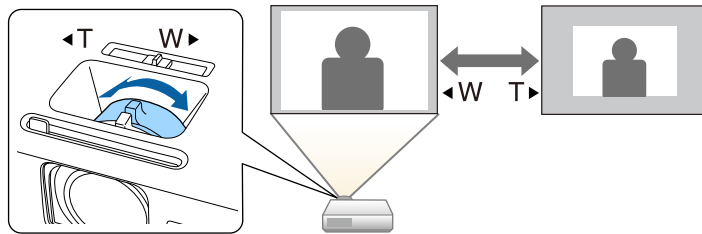

You can resize the image using the Wide and Tele buttons (EB-S31/EB-S04/EB-S130/EB-S300).

- 1** Turn on the projector and display an image.
- 2** Press the Wide button on the projector's control panel to enlarge the image size. Press the Tele button to reduce the image size.

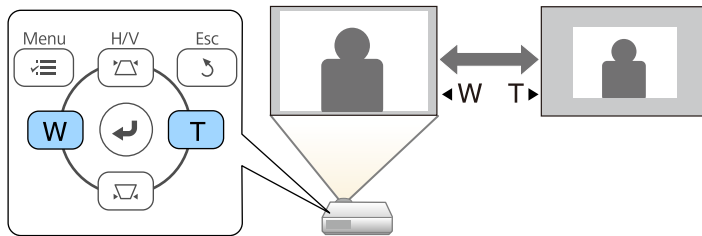

You can correct the focus using the focus ring.

EB-U32/EB-W32/EB-W31/EB-X36/EB-X31/EB-U04/EB-W04/EB-X04/EB-U130/EB-W130/EB-X130/EB-X350/EB-X300

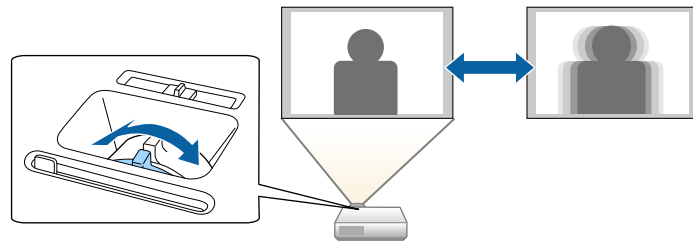

EB-S31/EB-S04/EB-S130/EB-S300

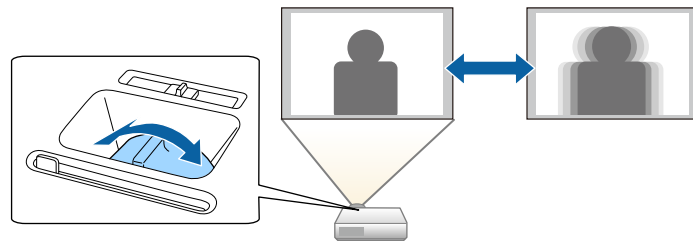

When multiple image sources are connected to the projector, such as a computer and DVD player, you can switch from one image source to the other.

- 1** Make sure the connected image source you want to use is turned on.
- 2** For video image sources, insert a DVD or other video media and press play.
- 3** Do one of the following:
 - Press the [Source Search] button on the control panel or remote control until you see the image from the source you want.

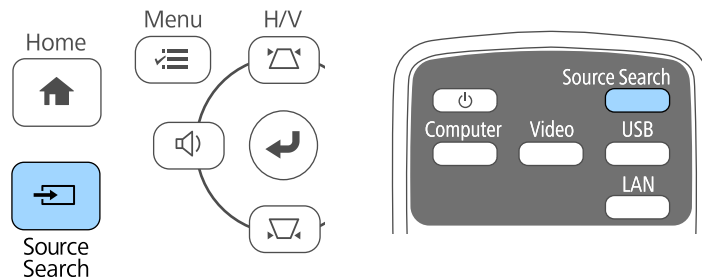

This screen is displayed when no image signal is detected. Check the cable connections between the projector and image source.

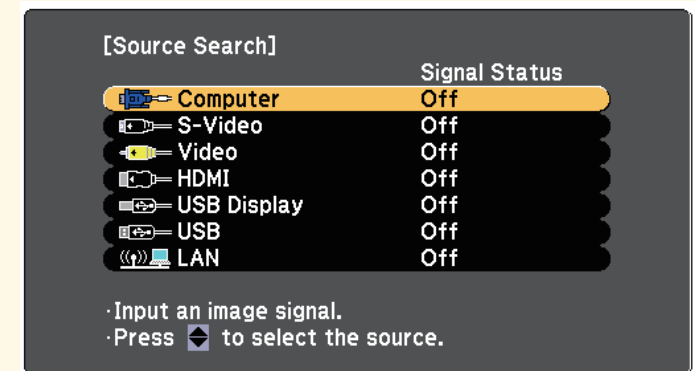

- Press the button for the source you want on the remote control. If there is more than one port for that source, press the button again to cycle through the sources.

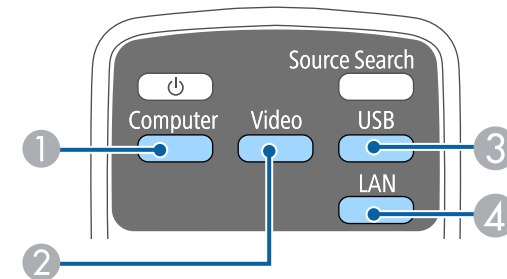

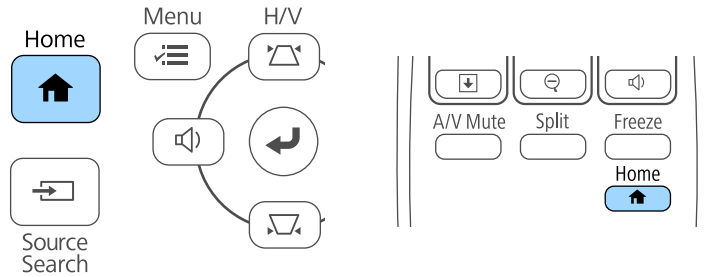

- ① Computer port source (Computer port)
- ② Video, S-Video, HDMI, and MHL sources (Video, S-Video, HDMI, and HDMI/MHL ports)
- ③ USB port sources (USB-B port and external devices connected to the USB-A port)
- ④ Network source (LAN)

- Press the [Home] button on the control panel or remote control.

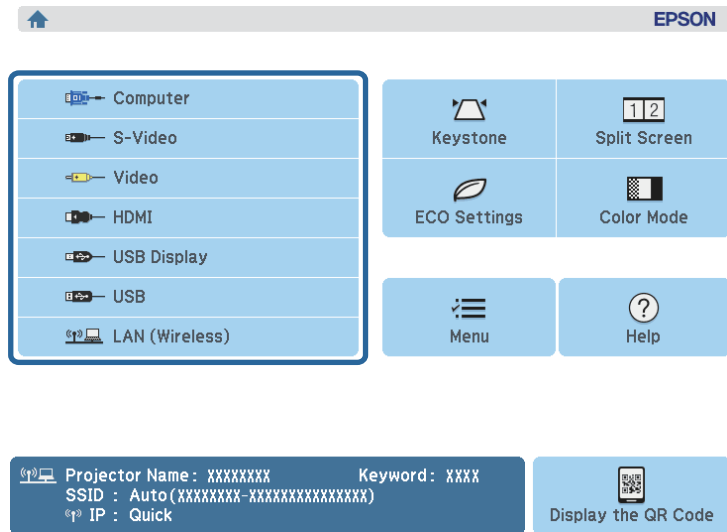

Then select the source you want to use from the screen displayed.



 S-Video is available with the EB-W32/EB-W31/EB-X36/EB-X31/EB-S31/EB-W04/EB-X04/EB-S04/EB-W130/EB-X130/EB-S130/EB-X350/EB-X300/EB-S300.

The projector can display images in different width-to-height ratios called aspect ratios. Normally, the input signal from your video source determines the image's aspect ratio. However, for certain images you can change the aspect ratio to fit your screen by pressing a button on the remote control.

If you always want to use a particular aspect ratio for a certain video input source, you can select it using the projector's **Signal** menu.

» **Related Links**

- "Changing the Image Aspect Ratio" [p.51](#)
- "Available Image Aspect Ratios" [p.51](#)
- "Projected Image Appearance with Each Aspect Mode" [p.52](#)
- "Input Signal Settings - Signal Menu" [p.103](#)

Changing the Image Aspect Ratio

You can change the aspect ratio of the displayed image.

- 1 Turn on the projector and switch to the image source you want to use.
- 2 Press the [Aspect] button on the remote control.

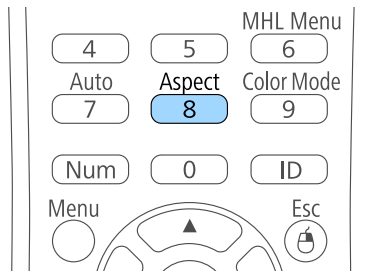

- 3 To cycle through the available aspect ratios for your input signal, press the [Aspect] button repeatedly.



To display images without black bars, set **Resolution** to **Wide** or **Normal** in the projector's **Signal** menu according to the computer's resolution.

» **Related Links**

- "Input Signal Settings - Signal Menu" [p.103](#)

Available Image Aspect Ratios

You can select the following image aspect ratios, depending on the input signal from your image source.





- Black bands and cropped images may project in certain aspect ratios, depending on the aspect ratio and resolution of your input signal.
- The **Auto** aspect ratio setting is available only for HDMI/MHL image sources.

For projectors with a resolution of WUXGA (1920 × 1200) or WXGA (1280 × 800)

Aspect mode	Description
Auto	Automatically sets the aspect ratio according to the input signal and the Resolution setting.
Normal	Displays images using the full projection area and maintains the aspect ratio of the image.
16:9	Converts the aspect ratio of the image to 16:9.
Full	Displays images using the full size of the projection area, but does not maintain the aspect ratio.
Zoom	Displays images using the full width of the projection area and maintains the aspect ratio of the image.
Native	Displays images as is (aspect ratio and resolution are maintained).

For projectors with a resolution of XGA (1024 × 768) or SVGA (800 × 600)

Aspect mode	Description
Auto	Automatically sets the aspect ratio according to the input signal and the Resolution setting.
4:3	Converts the aspect ratio of the image to 4:3.
16:9	Converts the aspect ratio of the image to 16:9.

Aspect mode	Aspect ratio for input signals		
	16:10	16:9	4:3
Native			













Projected Image Appearance with Each Aspect Mode

Black bands and cropped images may project in certain aspect ratios, depending on the aspect ratio and resolution of your input signal. See the following table to confirm the position of black bands and cropped images.











The image for **Native** varies depending on the input signal.

For projectors with a resolution of WUXGA (1920 × 1200) or WXGA (1280 × 800)

Aspect mode	Aspect ratio for input signals		
	16:10	16:9	4:3
Normal Auto			
16:9			
Full			
Zoom			

For projectors with a resolution of XGA (1024 × 768) or SVGA (800 × 600)

Aspect mode	Aspect ratio for input signals		
	16:10	16:9	4:3
Auto			
4:3			
16:9			

The projector offers different Color Modes to provide optimum brightness, contrast, and color for a variety of viewing environments and image types. You can select the mode designed to match your image and environment, or experiment with the available modes.

» **Related Links**

- "Changing the Color Mode" [p.53](#)
- "Available Color Modes" [p.53](#)
- "Setting Auto Iris" [p.53](#)

Changing the Color Mode

You can change the projector's Color Mode using the remote control to optimize the image for your viewing environment.

- 1 Turn on the projector and switch to the image source you want to use.
- 2 Press the [Color Mode] button on the remote control to change the Color Mode.

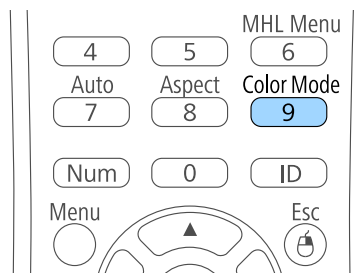

The name of the Color Mode appears briefly on the screen and then image appearance changes.

- 3 To cycle through all of the available Color Modes for your input signal, press the [Color Mode] button repeatedly.



You can also set the **Color Mode** setting in the projector's **Image** menu.

» **Related Links**

- "Image Quality Settings - Image Menu" [p.101](#)

Available Color Modes

You can set the projector to use these Color Modes, depending on the input source you are using:

Color Mode	Description
Presentation	Best for color presentations and television images in a bright room, with vivid images in sharp contrast.
Dynamic	Best for projecting in a bright room. This is the brightest mode.
Cinema	Best for movies projected in a dark room with natural tone images.
sRGB	Best for still images projected in a bright room that conform to the sRGB color standard.
Blackboard	Best for presentations onto a green chalkboard (adjusts the colors accordingly).

Setting Auto Iris

In **Dynamic** or **Cinema** color modes, you can turn on Auto Iris to automatically optimize the image based on the brightness of the content.

- 1 Turn on the projector and switch to the image source you want to use.

2 Press the [Menu] button on the control panel or remote control.

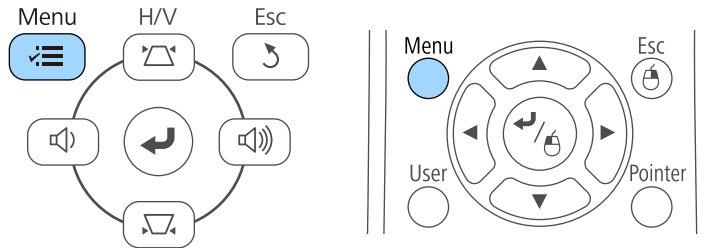

3 Select the **Image** menu and press [Enter].

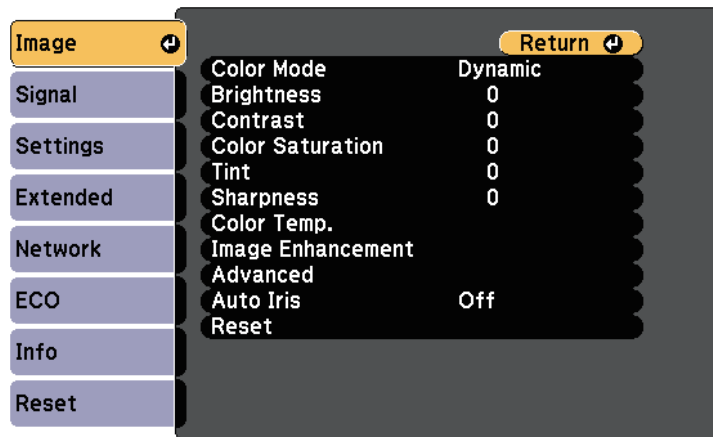

4 Select **Auto Iris** and press [Enter].

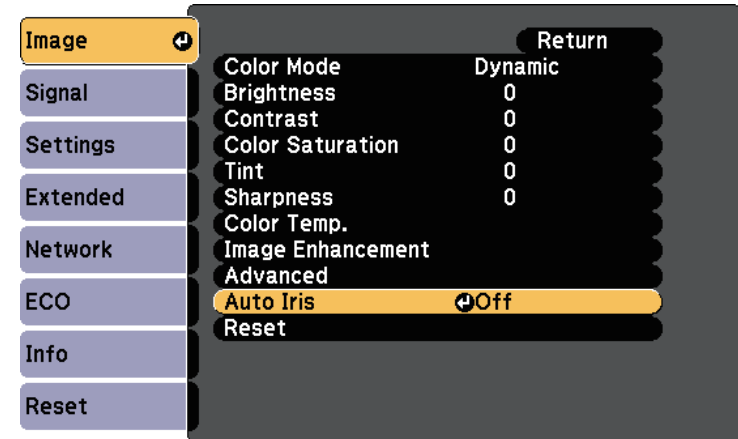

5 Choose one of the following options and press [Enter]:

- **High Speed** to adjust brightness as soon as the scene changes.
- **Normal** for standard brightness adjustment.

6 Press [Menu] or [Esc] to exit the menus.

The volume buttons control the projector's internal speaker system.
You must adjust the volume separately for each connected input source.

- 1 Turn on the projector and start a presentation.
- 2 To lower or raise the volume, press the [Volume] buttons on the control panel or remote control as shown.

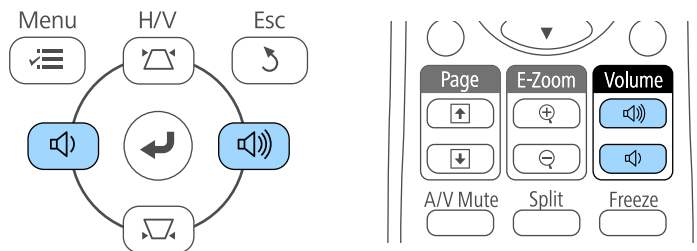

The [Volume] buttons on the control panel are available only with EB-U32/EB-W32/EB-W31/EB-X36/EB-X31/EB-U04/EB-W04/EB-X04/EB-U130/EB-W130/EB-X130/EB-X350/EB-X300.

A volume gauge appears on the screen.

- 3 To set the volume to a specific level for an input source, select **Volume** in the projector's **Settings** menu.

Caution

Do not start a presentation at a high volume setting. Sudden loud noises may cause hearing loss.

Always lower the volume before powering off, so that you can power on and then gradually increase the volume.

» Related Links

- "Projector Feature Settings - Settings Menu" [p.105](#)

Adjusting Projector Features

Follow the instructions in these sections to use your projector's adjustment features.

► **Related Links**

- "Projecting Two Images Simultaneously" [p.57](#)
- "Projecting a PC Free Presentation" [p.60](#)
- "Shutting Off the Image and Sound Temporarily" [p.65](#)
- "Stopping Video Action Temporarily" [p.66](#)
- "Zooming Images" [p.67](#)
- "Using the Remote Control as a Wireless Mouse" [p.68](#)
- "Using the Remote Control as a Pointer" [p.70](#)
- "Saving a User's Logo Image" [p.71](#)
- "Color Difference Correction when Projecting from Multiple Projectors" [p.73](#)
- "Projector Security Features" [p.76](#)

You can use the split screen feature to simultaneously project two images from different image sources. You can control the split screen feature using the remote control or the projector menus.

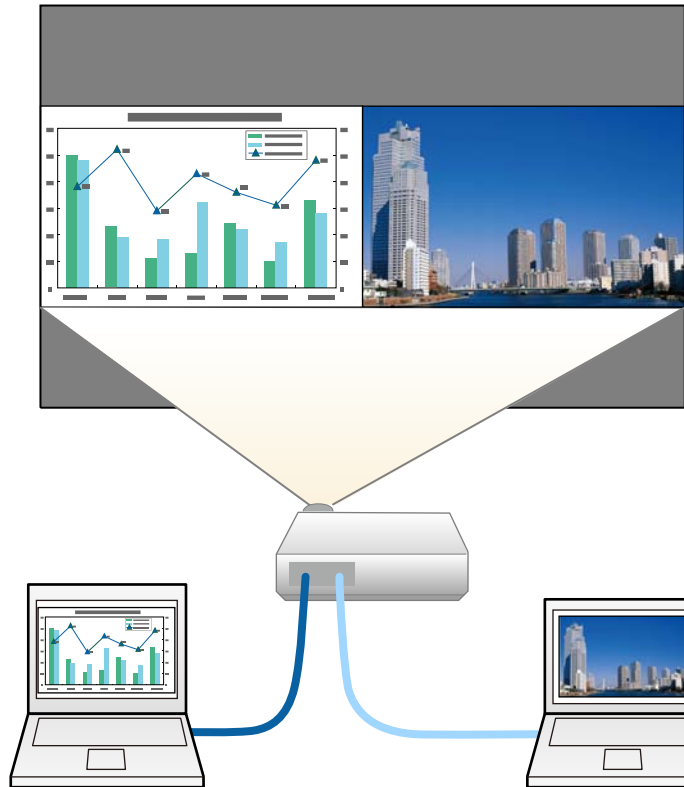

While using the split screen feature, other projector features may not be available and some settings may be automatically applied to both images.

- 1 Press [Split] button on the remote control.

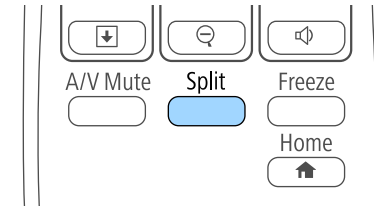

The currently selected input source moves to the left of the screen.



You can perform the same operations from **Split Screen** in the projector's **Settings** menu.

- 2 Press the [Menu] button.

You see this screen:

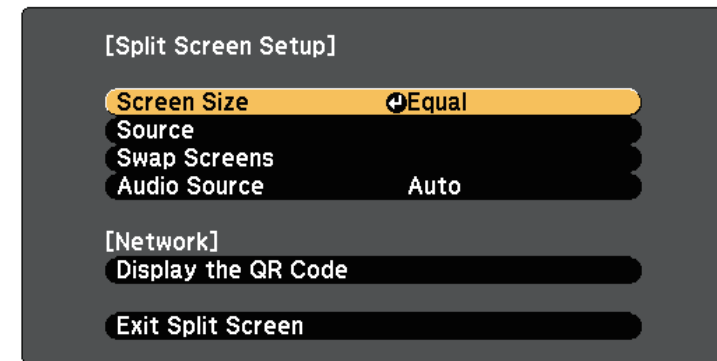

3 To select an input source for the other image, select the **Source** setting, press [Enter], select the input source, select **Execute**, and press [Enter].

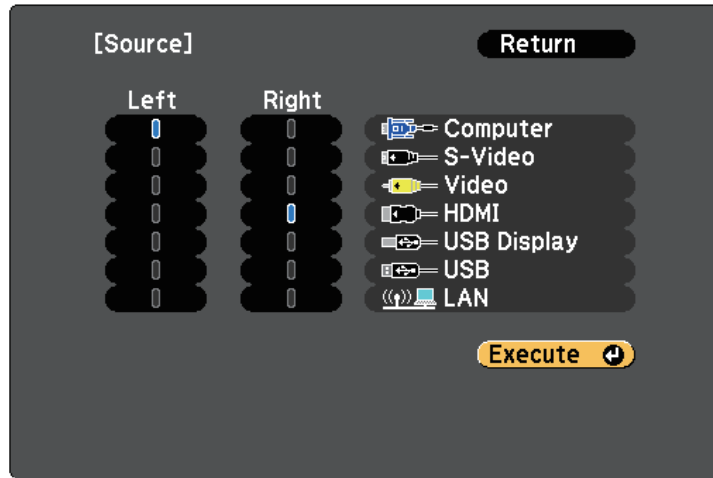

- You can only select input sources that can be combined.
- While using the split screen feature, the source screen appears when you change the input source from the remote control.

4 To switch images, select **Swap Screens** and press [Enter]. The projected images on the left and right are swapped.

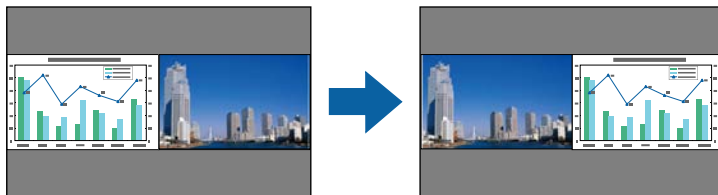

5 To enlarge one image while reducing the other image, select **Screen Size**, press [Enter], select a size, press [Enter], and press [Menu] to exit.



Depending on the video input signals, the images may not appear at the same size even if you select **Equal**.

6 To select the audio, select **Audio Source**, press [Enter], select an audio option, press [Enter], and press [Menu] to exit.

Select **Auto** to hear audio from the largest screen or the left screen.

7 To exit the split screen feature, press [Split] or [Esc].

» **Related Links**

- "Unsupported Input Source Combinations for Split Screen Projection" [p.58](#)
- "Split Screen Projection Restrictions" [p.59](#)

Unsupported Input Source Combinations for Split Screen Projection

These input source combinations cannot be projected on a split screen.

- Computer, Video and S-Video
- USB Display, USB and LAN

Split Screen Projection Restrictions

Operating restrictions

The following operations cannot be performed during split screen projection.

- Setting the projector's menu
- E-Zoom
- Switching the aspect mode (the aspect mode is set to **Normal**)
- Operations using the [User] button on the remote control
- Auto Iris



Help can only be displayed when no image signals are being input or when an error or warning notification is displayed.

Image restrictions

- If you make adjustments such as **Brightness**, **Contrast**, **Color Saturation**, **Tint**, and **Sharpness** in the projector's **Image** menu, you can apply them only to the image on the left. Default adjustments are applied to the image on the right. Adjustments that affect the entire projected image such as **Color Mode** and **Color Temp.** are applied for both left and right images.
- Even if you make adjustments for **Noise Reduction** and **Deinterlacing** in the projector's **Image** menu, **Noise Reduction** is set to 0 and **Deinterlacing** is set to **Off** for the image on the right.
- Even if you set **Display Background** to **Logo** in the projector's **Extended** menu, the blue screen appears when no image signal is being input.

» Related Links

- "Image Aspect Ratio" [p.51](#)
- "Color Mode" [p.53](#)
- "Input Signal Settings - Signal Menu" [p.103](#)
- "Projector Feature Settings - Settings Menu" [p.105](#)
- "Projector Setup Settings - Extended Menu" [p.107](#)
- "Zooming Images" [p.67](#)
- "Setting Auto Iris" [p.53](#)

You can use your projector's PC Free feature whenever you connect a USB device that contains compatible presentation files. This lets you quickly and easily display a presentation and control it using the projector's remote control.

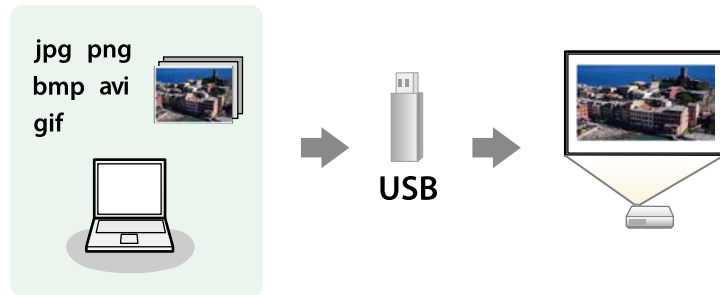

» **Related Links**

- "Supported PC Free File Types" [p.60](#)
- "Precautions on PC Free Projection" [p.60](#)
- "Starting a PC Free Slide Show" [p.61](#)
- "Starting a PC Free Movie Presentation" [p.62](#)
- "PC Free Display Options" [p.63](#)

Supported PC Free File Types

You can project these types of files using the projector's PC Free feature.

- For best results, place your files on media that is formatted in FAT16/32.
- If you have trouble projecting from media formatted for non-Windows file systems, try formatting the media for Windows instead.

File contents	File type (extension)	Details
Image	.jpg	Make sure the file is not: <ul style="list-style-type: none"> • CMYK format • Progressive format • Highly compressed • Above 8192 × 8192 resolution
	.bmp	Make sure the file resolution is not above 1280 × 800
	.gif	Make sure the file is not: <ul style="list-style-type: none"> • Above 1280 × 800 resolution • Animated
	.png	Make sure the file resolution is not above 1280 × 800
Movie	.avi (Motion JPEG)	Make sure the file is not: <ul style="list-style-type: none"> • Saved with an audio codec other than PCM or ADPCM • Above 1280 × 720 resolution • Larger than 2 GB

Precautions on PC Free Projection

Note the following precautions when using PC Free features.

- Do not disconnect the USB storage device while it is being accessed; otherwise, PC Free may not operate correctly.
- You may not be able to use the security features on certain USB storage devices with PC Free features.
- When connecting a USB device that includes an AC adapter, connect the AC adapter to an electrical outlet when you use the device with your projector.
- Some commercially available USB card readers may not be compatible with the projector.
- The projector can recognize up to 5 cards inserted into the connected card reader at one time.

- You cannot correct keystone distortion while projecting in PC Free, so correct the image shape before you begin your presentation.
- You can use the following functions while projecting in PC Free.
 - Freeze
 - A/V Mute
 - E-Zoom
 - Pointer

» Related Links

- "Stopping Video Action Temporarily" [p.66](#)
- "Shutting Off the Image and Sound Temporarily" [p.65](#)
- "Zooming Images" [p.67](#)
- "Using the Remote Control as a Pointer" [p.70](#)

Starting a PC Free Slide Show

After connecting a USB device to the projector, you can switch to the USB input source and start your slide show.



You can change the PC Free operation options or add special effects by highlighting **Option** at the bottom of the screen and pressing [Enter].

- 1** Press the [USB] button on the remote control.

The PC Free file list screen is displayed.



- If the Select Drive screen is displayed, press the arrow buttons to select the drive and press [Enter].
- To display the Select Drive screen, highlight **Select Drive** at the top of the file list screen and press [Enter].

- 2** Do one of the following to locate your files:
 - If you need to display files inside a subfolder on your device, press the arrow buttons to highlight the folder and press [Enter].
 - To move back up a folder level on your device, highlight **Back to Top** and press [Enter].
 - To view additional files in a folder, highlight **Next Page** or **Previous Page** and press [Enter], or press the [Page] up or down buttons on the remote control.
- 3** Do one of the following:
 - To display an individual image, press the arrow buttons to highlight the image and press [Enter]. (Press the [Esc] button to return to the file list screen.)

- To display a slide show of all the images in a folder, press the arrow buttons to highlight the **Slideshow** option at the bottom of the screen and press [Enter].

 You can change the image switching time by highlighting **Option** at the bottom of the screen and pressing [Enter].

- If any file names are longer than the display area or include unsupported symbols, the file names may be shortened or changed only on the screen display.

- 4** While projecting, use the following commands to control the display:
- To rotate a displayed image, press the up or down arrow button.

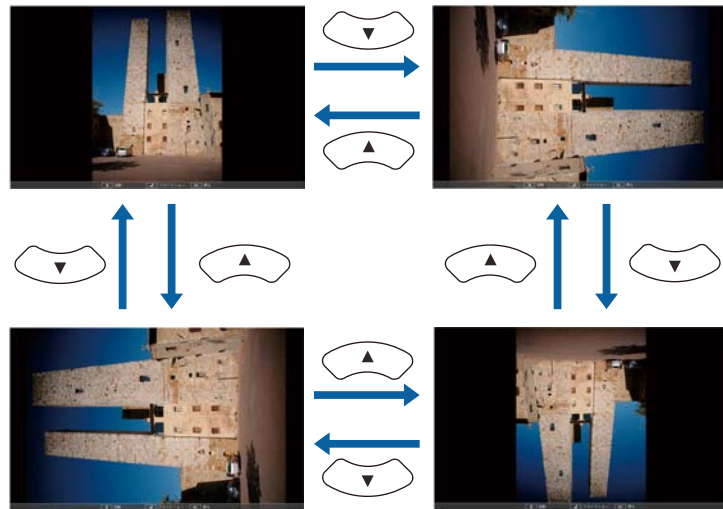

- To move to the next or previous image, press the left or right arrow button.

- 5** To stop the display, follow the on-screen instructions or press the [Esc] button.

You return to the file list screen.

- 6** Turn off the USB device, if necessary, and then disconnect the device from the projector.

» **Related Links**

- "PC Free Display Options" [p.63](#)
- "Connecting to a USB Device" [p.27](#)

Starting a PC Free Movie Presentation

After connecting a USB device to the projector, you can switch to the USB input source and start your movie.

 You can change the PC Free operation options by highlighting **Option** at the bottom of the screen and pressing [Enter].

- 1** Press the [USB] button on the remote control.
The PC Free file list screen is displayed.





- If the Select Drive screen is displayed, press the arrow buttons to select the drive and press [Enter].
- To display the Select Drive screen, highlight **Select Drive** at the top of the file list screen and press [Enter].

- 2** Do one of the following to locate your files:
- If you need to display files inside a subfolder on your device, press the arrow buttons to highlight the folder and press [Enter].
 - To move back up a folder level on your device, highlight **Back to Top** and press [Enter].
 - To view additional files in a folder, highlight **Next Page** or **Previous Page**, and press [Enter], or press the [Page] up or down buttons on the remote control.

- 3** To play back a movie, press the arrow buttons to highlight the file and press [Enter].



- If any file names are longer than the display area or include unsupported symbols, the file names may be shortened or changed only on the screen display.
- If you want to play back all the movies in a folder in sequence, select the **Slideshow** option at the bottom of the screen.

- 4** To stop movie playback, press the [Esc] button, highlight **Exit**, and press [Enter].
You return to the file list screen.

- 5** Turn off the USB device, if necessary, and then disconnect the device from the projector.

» **Related Links**

- "PC Free Display Options" [p.63](#)
- "Connecting to a USB Device" [p.27](#)

PC Free Display Options

You can select these display options when using PC Free. To access this screen, highlight **Option** at the bottom of the PC Free file list screen and press [Enter].



Setting	Options	Description
Display Order	Name Order	Displays files in name order
	Date Order	Displays files in date order
Sort Order	In Ascending	Sorts files in first-to-last order
	In Descending	Sorts files in last-to-first order
Continuous Play	On	Displays a slide show continuously
	Off	Displays a slide show once
Screen Switching Time	No	Does not display the next file automatically
	1 Second to 60 Seconds	Displays files for the selected time and switches to the next file automatically; high resolution images may switch at a slightly slower rate

Setting	Options	Description
Effect	No	No effect
	Wipe	Transitions between images using a wipe effect
	Dissolve	Transitions between images using a dissolve effect
	Random	Transitions between images using a random variety of effects

You can temporarily turn off the projected image and sound if you want to redirect your audience's attention during a presentation. Any sound or video action continues to run, however, so you cannot resume projection at the point that you stopped it.

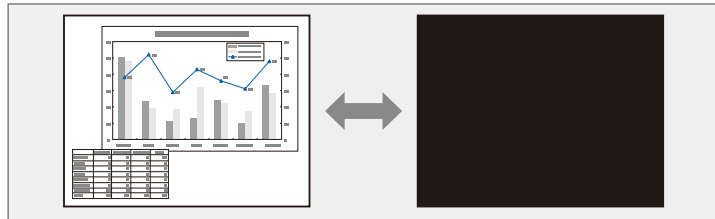

If you want to display an image such as a company logo or picture when the [A/V Mute] button is pressed, you can select the screen displayed in the **A/V Mute** setting in the projector's **Extended** menu.

☛ **Extended > Display > A/V Mute**

- 1** Press the [A/V Mute] button on the remote control to temporarily stop projection and mute any sound.

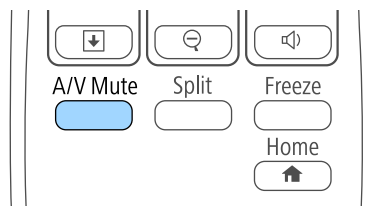

- 2** To turn the image and sound back on, press [A/V Mute] again.



- You can also stop projection using the A/V Mute slide lever on the projector.
- The projector's power automatically turns off 30 minutes after A/V Mute is enabled. You can disable this feature in the projector's **ECO** menu.
 - ☛ **ECO > Lens Cover Timer**
 - ☛ **ECO > A/V Mute Timer**
- The lamp is still operating during A/V Mute, so the lamp hours continue to accumulate.

» Related Links

- "Projector Setup Settings - Extended Menu" [p.107](#)
- "Projector Setup Settings - ECO Menu" [p.115](#)

You can temporarily stop the action in a video or computer presentation and keep the current image on the screen. Any sound or video action continues to run, however, so you cannot resume projection at the point that you stopped it.

- 1** Press the [Freeze] button on the remote control to stop the video action.

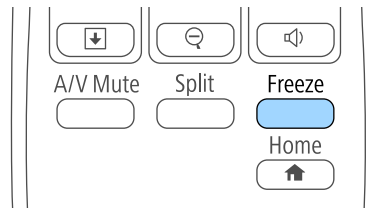

- 2** To restart the video action in progress, press [Freeze] again.

You can draw attention to parts of a presentation by zooming into a portion of the image and enlarging it on the screen.

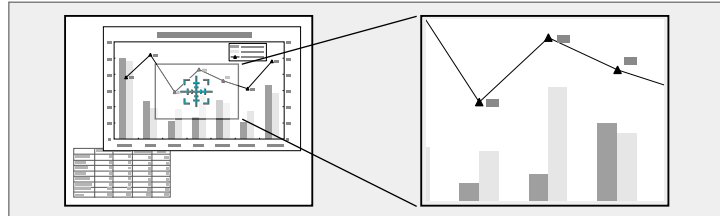

The enlarged image is projected and the enlargement ratio is displayed on the screen.

- 1 Press the [E-Zoom +] button on the remote control.

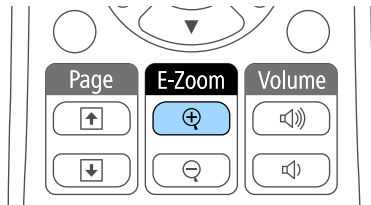

You see a crosshair on the screen indicating the center of the zoom area.

- 2 Use the following buttons on the remote control to adjust the zoomed image:
 - Use the arrow buttons to position the crosshair in the image area you want to zoom into. To move the crosshair diagonally, press any pair of adjacent arrow buttons at the same time.
 - Press the [E-Zoom +] button repeatedly to zoom into the image area. Press and hold the [E-Zoom +] button to zoom in more quickly. The selected area can be enlarged to between one to four times in 25 incremental steps.
 - To pan around the zoomed image area, use the arrow buttons.
 - To zoom out of the image, press the [E-Zoom -] button.
 - To return to the original image size, press [Esc].

You can use the projector's remote control as a wireless mouse so you can control projection at a distance from the computer.



You can use the wireless mouse features with Windows 2000 and later, or OS X 10.3.x and later.

- 1** Connect the projector to a computer using the projector's USB-B, Computer, or HDMI port.



The wireless mouse function does not work when projecting images from a device connected to the HDMI/MHL port using an MHL cable.

- 2** If you connected your computer to the port other than the USB-B port, also connect a USB cable to the projector's USB-B port and to a USB port on your computer (for wireless mouse support).
- 3** Start your presentation.

- 4** Use the following buttons on the remote control to control your presentation:

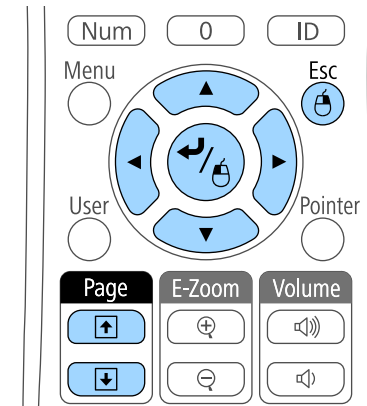

- To move through slides or pages, press the [Page] up or down buttons.
- To move the cursor on the screen, use the arrow buttons. To move the cursor diagonally, press any pair of adjacent arrow buttons at the same time.
- To left-click, press the [Enter] button once (press it twice to double-click). To right-click, press the [Esc] button.
- To drag-and-drop, hold the [Enter] button as you move the cursor with the arrow buttons, then release [Enter] at the destination.



- If the mouse button settings are set to reverse on the computer, the operation of the remote control buttons is also reversed.
- The Wireless Mouse function does not work under the following conditions:
 - When the projector's menu or a Help screen is displayed.
 - When operating functions other than the Wireless Mouse function (such as adjusting the volume). However, when using the E-Zoom or Pointer function, the page up or down function is available.

» Related Links

- "Zooming Images" [p.67](#)
- "Using the Remote Control as a Pointer" [p.70](#)

You can use the projector's remote control as a pointer to help you focus your audience on important information on the screen. The default pointer shape is an arrow. You can change the shape in the **Pointer Shape** setting in the projector's **Settings** menu.

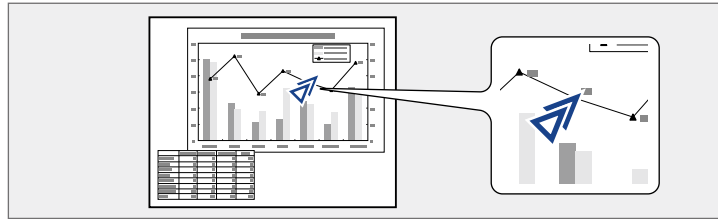

1 Press the [Pointer] button on the remote control.

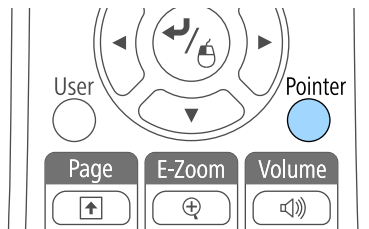

2 Use the arrow buttons to move the pointer on the screen. To move the pointer diagonally, press any pair of adjacent arrow buttons at the same time.

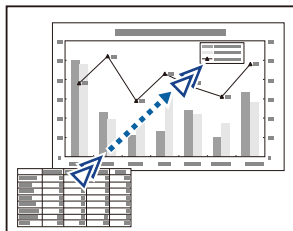

3 Press [Esc] to remove the pointer from the screen.

» Related Links

- "Projector Feature Settings - Settings Menu" [p.105](#)

You can save an image on the projector and display it whenever the projector turns on. You can also display the image when the projector is not receiving an input signal or when you temporarily stop projection (using A/V Mute). This image is called the user's logo screen.

You can select a photo, graphic, or company logo as the user's logo, which is useful in identifying the projector's owner to help deter theft. You can prevent changes to the user's logo by setting up password protection.

-  • Once you save a user's logo, you cannot return to the factory default logo.
- If the **User's Logo Protection** setting is set to **On** in the **Password Protection** menu, set to **Off** before saving the user's logo.
- When you copy the menu settings from one projector to another using the batch setup feature, user's logo is also copied. Do not register the information that you do not want to share between multiple projectors as a user's logo.

4 Select **User's Logo** and press [Enter].

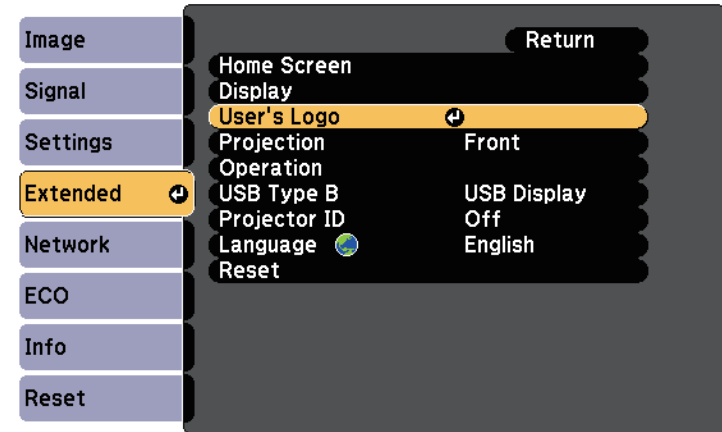

You see a prompt asking if you want to use the displayed image as a user's logo.

-  Adjustments such as Keystone, E-Zoom, or Aspect are temporarily cancelled when you select **User's Logo**.

- 1** Display the image you want to project as the user's logo.
- 2** Press the [Menu] button on the control panel or remote control.
- 3** Select the **Extended** menu and press [Enter].

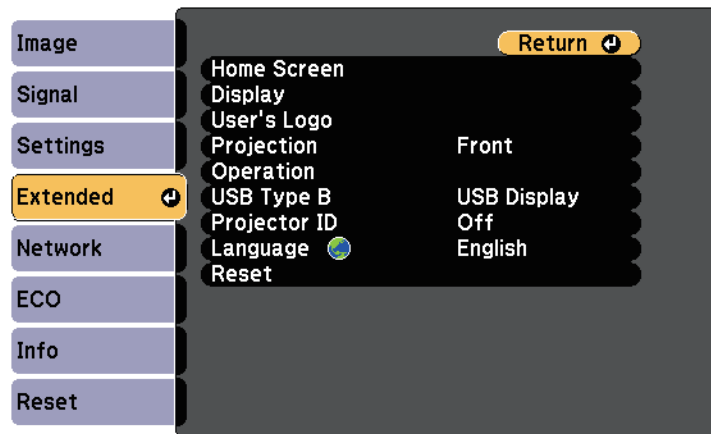

5 Select **Yes** and press [Enter].

You see a selection box overlaying your image.

-  Depending on the current image signal, the screen size may change to match the resolution of the image signal.

- 6** Use the arrow buttons to surround the image area you want to use as the user's logo and press [Enter].

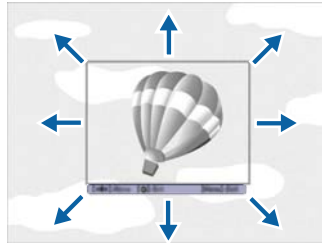

You see a prompt asking if you want to select this image area.



You cannot change the image area size (400 × 300 pixels).

- 7** Select **Yes** and press [Enter]. (If you want to change the selected area, select **No**, press [Enter], and repeat the last step.)

You see the User's Logo zoom factor menu.

- 8** Select a zoom percentage and press [Enter].

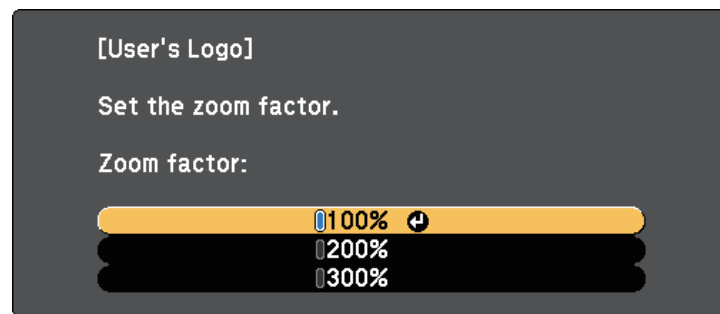

You see a prompt asking if you want to save the image as the user's logo.

- 9** Select **Yes** and press [Enter].
The user's logo is overwritten and a completion message appears.

- 10** Press [Esc] to exit the message screen.

- 11** Select the **Extended** menu and press [Enter].

- 12** Select **Display** and press [Enter].

- 13** Select when you want to display the User's Logo screen:

- To display it whenever there is no input signal, select **Display Background** and set it to **Logo**.
- To display it whenever you turn the projector on, select **Startup Screen** and set it to **On**.
- To display it whenever you press the [A/V Mute] button, select **A/V Mute** and set it to **Logo**.

To prevent anyone from changing the User's Logo settings without first entering a password, set the **User's Logo Protection** setting to **On** in the **Password Protection** menu and set the password.

» Related Links

- "Shutting Off the Image and Sound Temporarily" [p.65](#)
- "Selecting Password Security Types" [p.77](#)

When lining up multiple projectors to project images, you can correct the brightness and color tone of each projector's image so that the images match closely.

You can set a unique projector ID for each projector to operate them individually using a remote control, and then correct the brightness and color for each projector.



- In some cases the brightness and color tone may not match completely even after correction.
- If brightness and color tone differences become more noticeable over time, repeat the adjustments.

► Related Links

- "Setting the Projector ID" [p.73](#)
- "Selecting the Projector You want to Operate" [p.73](#)
- "Matching Multiple-Projector Display Quality" [p.75](#)

Setting the Projector ID

If you want to control multiple projectors from a remote control, give each projector a unique ID.

- 1** Press the [Menu] button on the control panel or remote control.
- 2** Select the **Extended** menu and press [Enter].
- 3** Select **Projector ID** and press [Enter].

- 4** Use the arrow buttons to select the identification number you want to use for the projector. Then press [Enter].

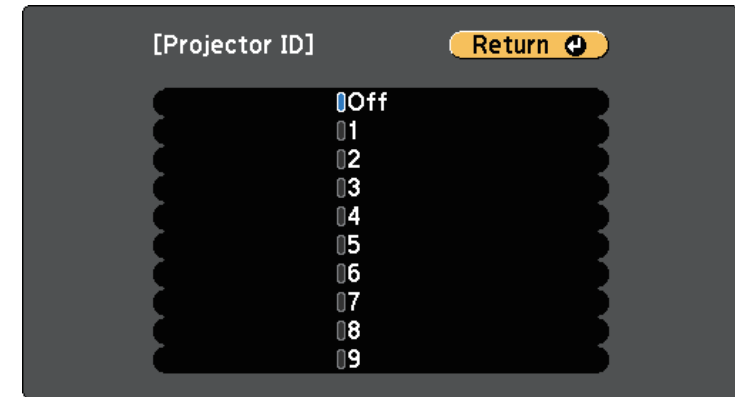

- 5** Press [Menu] or [Esc] to exit the menus.

Repeat these steps for all the other projectors you want to operate from one remote control.

Selecting the Projector You want to Operate

After setting the projector's ID, select the ID for the projector you want to operate using the remote control.

- 1 Aim the remote control at the target projector and press the [ID] button.

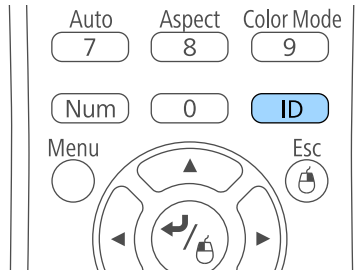

The current Projector ID is displayed on the projected screen. It disappears after about 3 seconds.

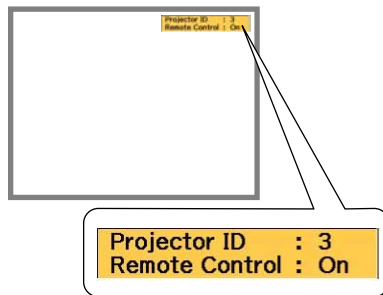

- 2 While holding the [ID] button, press the number button that matches the ID of the projector you want to operate.

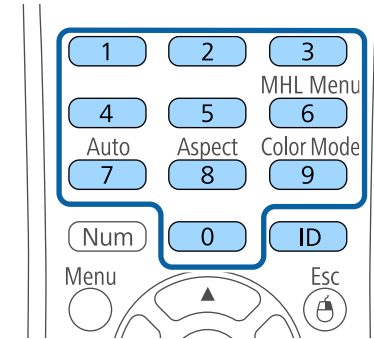

The projector you want to operate is selected.

- 3 Press the [ID] button to check if the ID-setting process worked. You see a message displayed by the projector.
 - If the remote control is listed as **On**, you can operate the projector from the remote control.
 - If the remote control is listed as **Off**, you cannot operate the projector from the remote control. Repeat the steps above to enable the remote control.



- You must select the projector ID from the remote control each time you turn on the projector you have set it to control. When you turn on the projector, 0 is selected as the remote control's projector ID.
- When you set the **Projector ID** setting to **Off**, you can operate the projector using the remote control whichever ID you select on the remote control.
- When you select 0 on the remote control, you can operate all projectors regardless the Projector ID setting.

Matching Multiple-Projector Display Quality

You can match the display quality of multiple projectors that will project next to each other.

- 1** Turn on all the projectors on which you want to match the display quality.
- 2** Set ID numbers on each projector.
- 3** Make sure all the projectors are using the same Color Mode setting.
- 4** Select the remote control ID to match the first projector.
- 5** Press the [Menu] button, select the **Image** menu, and press [Enter].

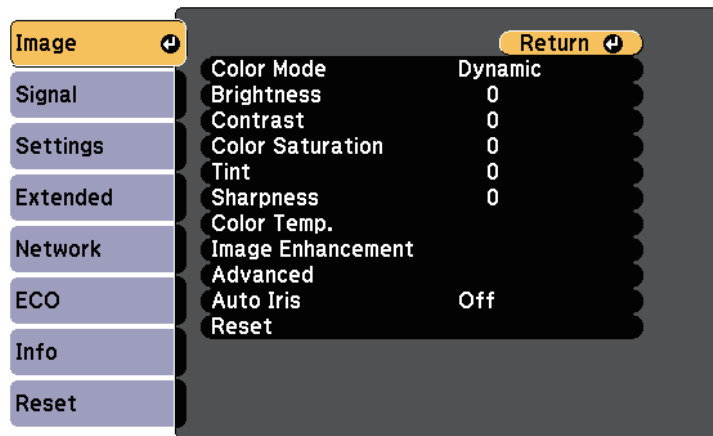

- 6** Select settings as necessary.
- 7** Select the remote control ID to match the next projector, then repeat Image menu adjustments as necessary to match the projectors' displays.

You can secure your projector to deter theft or prevent unintended use by setting up the following security features:

- Password security to prevent people who do not know the password from using the projector, and prevent changes to the startup screen and other settings. This acts as an anti-theft function as the projector cannot be used even if it is stolen, and you can limit who can use the projector.
- Button lock security to block operation of the projector using the buttons on the control panel. This is useful at events or shows when you want to deactivate all buttons during projection or at schools when you want to limit button operation.
- Security cabling to physically secure the projector in place.

» Related Links

- "Password Security Types" [p.76](#)
- "Locking the Projector's Buttons" [p.78](#)
- "Installing a Security Cable" [p.80](#)

Password Security Types

You can set up the following types of password security using one shared password:

- **Power On Protection** password prevents anyone from using the projector without first entering a password. When plugging the power cord and turning on the projector at first time, you must enter the correct password. This also applies to Direct Power On and Auto Power On.
- **User's Logo Protection** password prevents anyone from changing the custom screen displayed when the projector turns on, when no signal is being input, or when you use the A/V Mute feature. The custom screen discourages theft by identifying the projector's owner.
- **Network Protection** password prevents anyone from changing the projector's **Network** settings.

» Related Links

- "Setting a Password" [p.76](#)
- "Selecting Password Security Types" [p.77](#)
- "Entering a Password to Use the Projector" [p.78](#)

Setting a Password

To use password security, you must set a password.



The default password is set to "0000". Change this to your own password.

- 1** Hold down the [Freeze] button on the remote control for about 5 seconds.

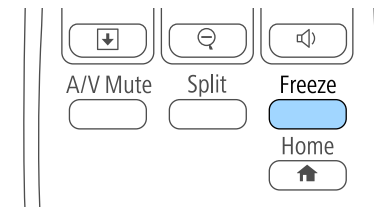

You see the Password Protection setting menu.



If Password Protection is already activated, you must enter the correct password to display the Password Protection setting menu.

- 2** Select **Password** and press [Enter].

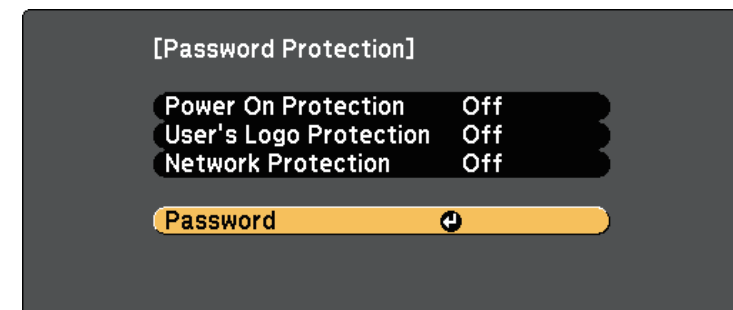

You see the prompt "Change the password?".

- 3 Select **Yes** and press [Enter].



If you select **No**, the Password Protection setting menu is displayed again.

- 4 Hold down the [Num] button on the remote control and use the numeric buttons to set a four-digit password.

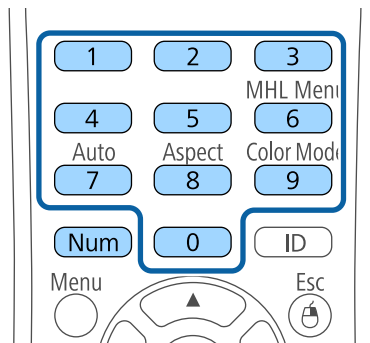

The password displays as **** as it is entered. A confirmation prompt is displayed when you enter the fourth digit.

- 5 Enter the password again.

You see the message "Password accepted". If you enter the password incorrectly, a message is displayed prompting you to re-enter the password.

- 6 Press [Esc] to return to the menu.

- 7 Make a note of the password and keep it in a safe place.

Selecting Password Security Types

After setting a password, you see this menu, allowing you to select the password security types you want to use.

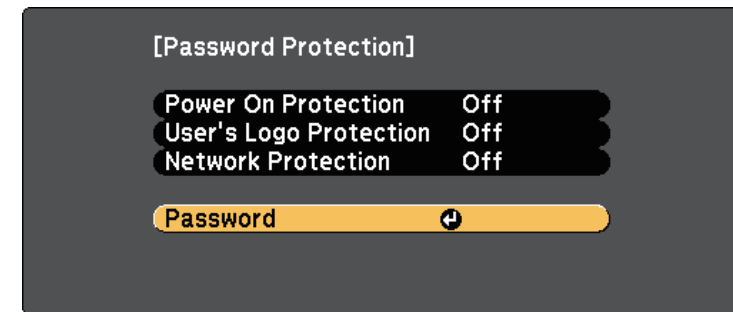

If you do not see this menu, hold down the [Freeze] button on the remote control for 5 seconds until the menu appears.

- To prevent unauthorized use of the projector, select **On** as the **Power On Protection** setting.
- To prevent changes to the User's Logo screen or related display settings, select **On** as the **User's Logo Protection** setting.
- To prevent changes to network settings, select **On** as the **Network Protection** setting.

You can attach the password protect sticker to the projector as an additional theft deterrent.



Be sure to keep the remote control in a safe place; if you lose it, you will not be able to enter the password.

Entering a Password to Use the Projector

When the password screen is displayed, enter the correct password.

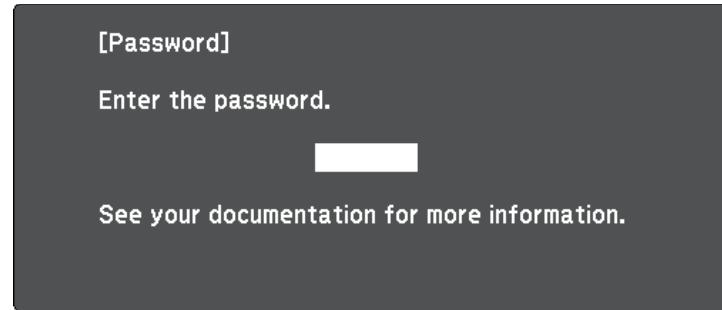

Attention

- If an incorrect password is entered three times in succession, the message "The projector's operation will be locked." is displayed for approximately 5 minutes, and the projector switches to standby mode. If this happens, disconnect the power plug from the electrical outlet, reinsert it, and turn the projector back on. The projector displays the password entry screen again so that you can enter the correct password.
- If you have forgotten the password, make a note of the "Request Code: xxxxx" number that appears on the screen and contact Epson for help.
- If you continue to repeat the above operation and input the wrong password 30 times in succession, the message "The projector's operation will be locked. Contact Epson as described in your documentation." is displayed and the projector does not accept any more password entries. Contact Epson for help.

- 1 Hold down the [Num] button on the remote control while you enter the password using the numeric buttons.

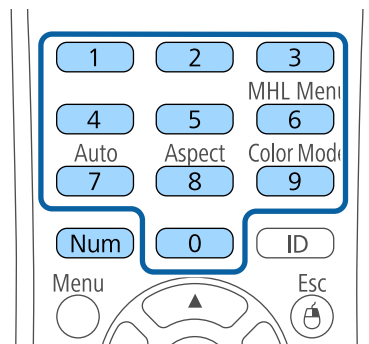

The password screen closes.

- 2 If the password is incorrect, you see a message and a prompt to try again. Enter the correct password to proceed.

Locking the Projector's Buttons

You can lock the buttons on the control panel to prevent anyone from using the projector. You can lock all the buttons or all the buttons except the power button. The projector can still be operated using the remote control.

- 1 Press the [Menu] button on the control panel or remote control.

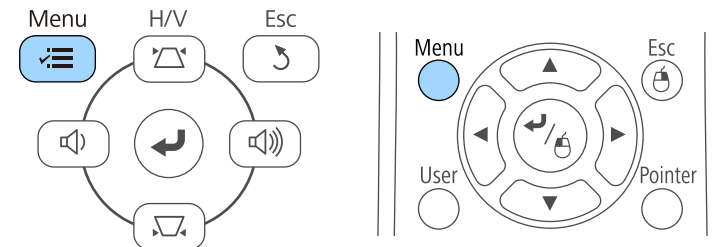

2 Select **Settings** and press [Enter].

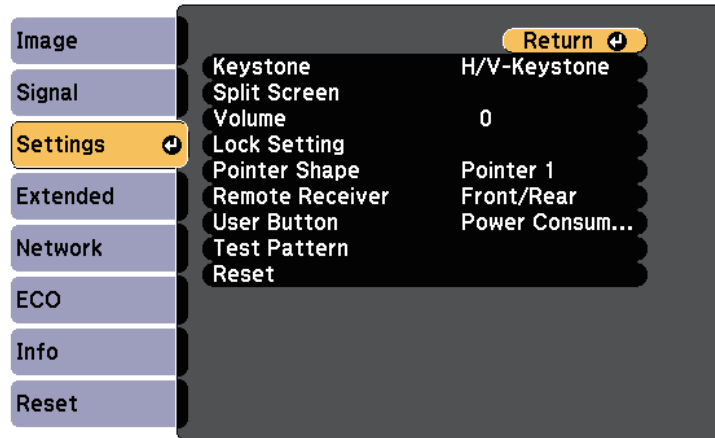

4 Select **Control Panel Lock** and press [Enter].

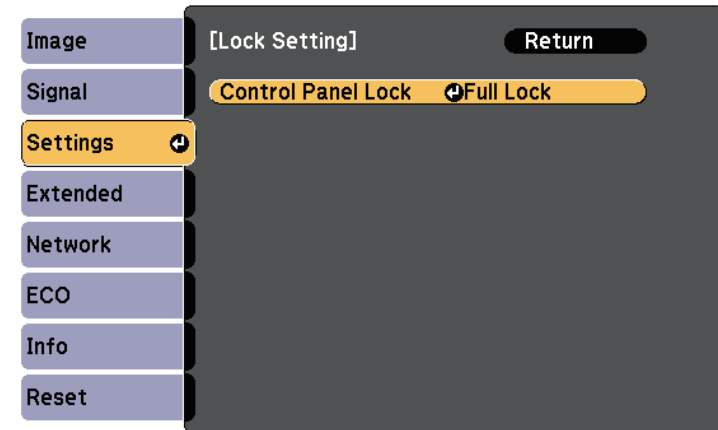

3 Select **Lock Setting** and press [Enter].

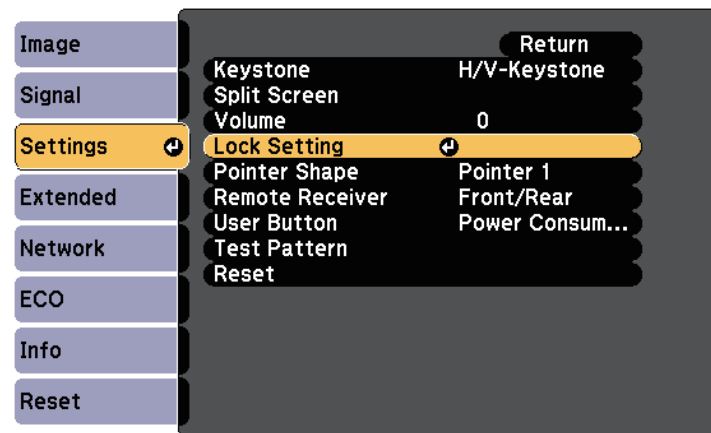

5 Select one of these lock types and press [Enter]:

- To lock all of the projector's buttons, select **Full Lock**.
- To lock all buttons except the power button, select **Partial Lock**.
You see a confirmation prompt.

6 Select **Yes** and press [Enter].

The control panel buttons are locked using the setting you chose.

» Related Links

- "Unlocking the Projector's Buttons" [p.79](#)

Unlocking the Projector's Buttons

If the projector's buttons have been locked, do one of the following to unlock them.

- Hold down the [Enter] button on the control panel for 7 seconds.

A message is displayed and the lock is released.

- Select **Off** as the **Control Panel Lock** setting in the projector's **Settings** menu.

☛ **Settings > Lock Setting > Control Panel Lock**

» Related Links

- "Projector Feature Settings - Settings Menu" [p.105](#)

Installing a Security Cable

You can install two types of security cables on the projector to deter theft.

- Use the security slot on the projector to attach a Kensington Microsaver Security system.



For more details on the Microsaver Security System, see <http://www.kensington.com/>.

- Use the security cable attachment point on the projector to attach a wire cable and secure it to a room fixture or heavy furniture.

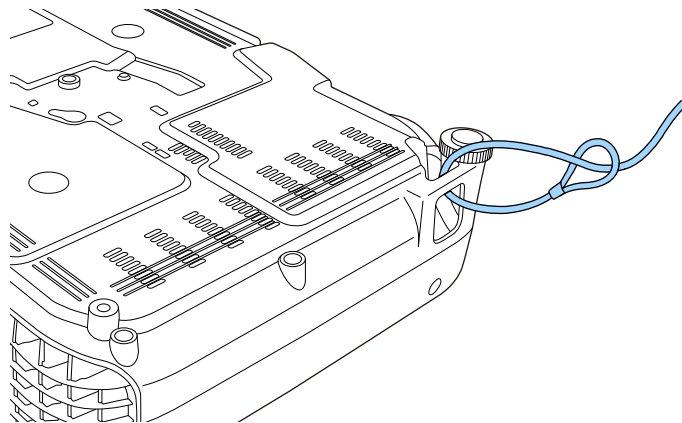

You can use a commercially available theft-prevention wire lock. See the documentation supplied with the wire lock for locking instructions.

Using the Projector on a Network

Follow the instructions in these sections to set up your projector for use on a network.

► **Related Links**

- "Wireless Network Projection" [p.82](#)
- "Using a QR Code to Connect a Mobile Device" [p.87](#)
- "Using Quick Wireless Connection (Windows Only)" [p.89](#)

You can send images to your projector through a wireless network.

- To do this, you must install the Epson 802.11b/g/n wireless LAN module, and then set up your projector and computer for wireless projection (EB-W31/EB-X36/EB-X31/EB-S31/EB-U04/EB-W04/EB-X04/EB-S04/EB-U130/EB-W130/EB-X130/EB-S130/EB-X350/EB-X300/EB-S300).
- Some models have built-in wireless LAN modules (EB-U32/EB-W32). You don't need to install the Epson 802.11b/g/n wireless LAN module.

There are two ways to connect the projector to your wireless network:

- Using the optional Quick Wireless Connection USB Key (Windows only)
- Configuring the connection manually using the projector's **Network** menus

After installing the wireless LAN module and setting up the projector, install the network software from the Epson Projector Software CD-ROM (if available) or download the software, as necessary. Use the following software and documentation to set up and control wireless projection:

- EasyMP Network Projection software sets up your computer for wireless network projection. See the *EasyMP Network Projection Operation Guide* for instructions.
- EasyMP Multi PC Projection software allows you to hold interactive meetings by projecting the computer screens of users over a network. See the *EasyMP Multi PC Projection Operation Guide* for instructions.

» Related Links

- "Installing the Wireless LAN Module" [p.82](#)
- "Selecting Wireless Network Settings Manually" [p.83](#)
- "Selecting Wireless Network Settings in Windows" [p.85](#)
- "Selecting Wireless Network Settings in OS X" [p.85](#)
- "Setting Up Wireless Network Security" [p.85](#)

Installing the Wireless LAN Module

To use the projector over a wireless network, install the Epson 802.11b/g/n wireless LAN module (EB-W31/EB-X36/EB-X31/EB-S31/EB-U04/EB-W04/EB-X04/EB-S04/EB-U130/EB-W130/EB-X130/EB-S130/EB-X350/EB-X300/EB-S300). Do not install any other type of wireless LAN module.

Attention

Never remove the module while its indicator is blue or flashing, or while you are projecting wirelessly. This could damage the module or lose data.

- 1** Use a cross-head screwdriver to remove the screw that secures the wireless LAN module cover.

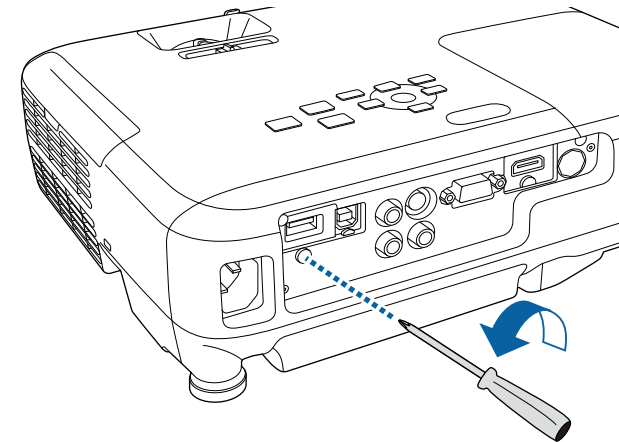

- 2** Connect the wireless LAN module to the USB-A port.

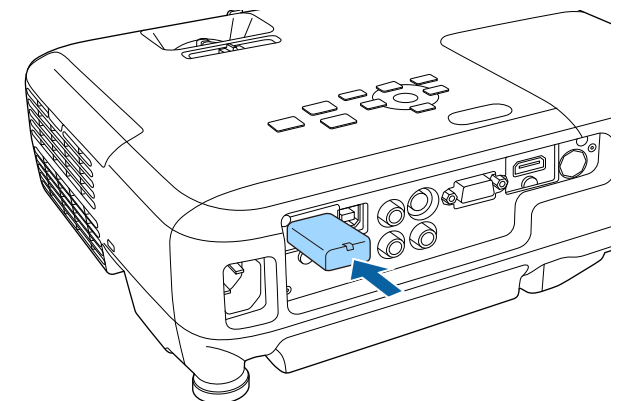

- 3 Attach the wireless LAN module cover, and secure it in place with the screw.

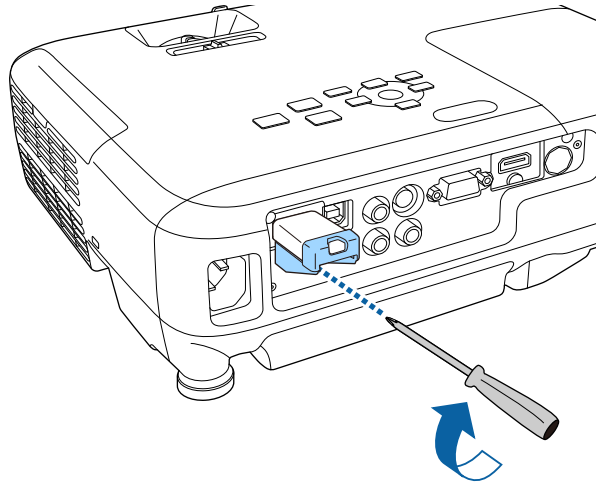

Selecting Wireless Network Settings Manually

Before you can project from your wireless network, you need to select network settings for the projector.

- 1 Press the [Menu] button on the control panel or remote control.

- 2 Select the **Network** menu and press [Enter].

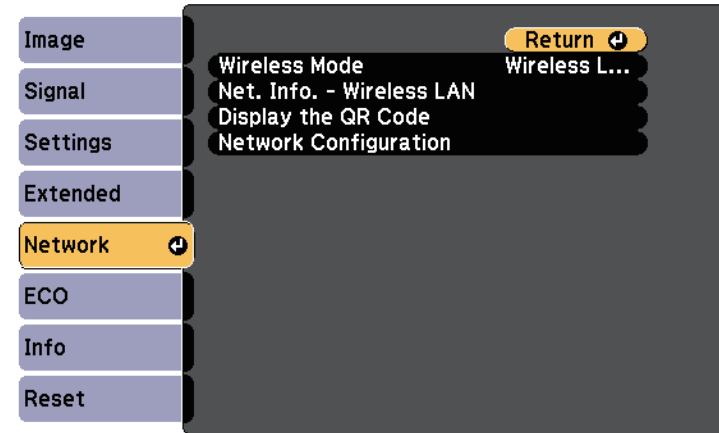

- 3 Select **Wireless LAN On** as the **Wireless Mode** setting.

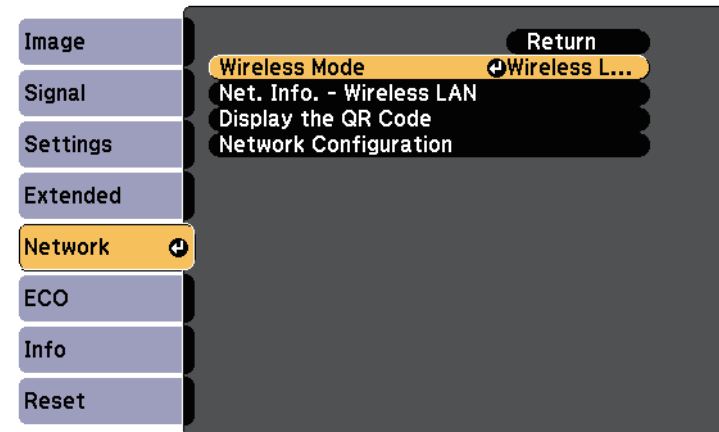

- 4 Select **Network Configuration** and press [Enter].

5 Select the **Basic** menu and press [Enter].

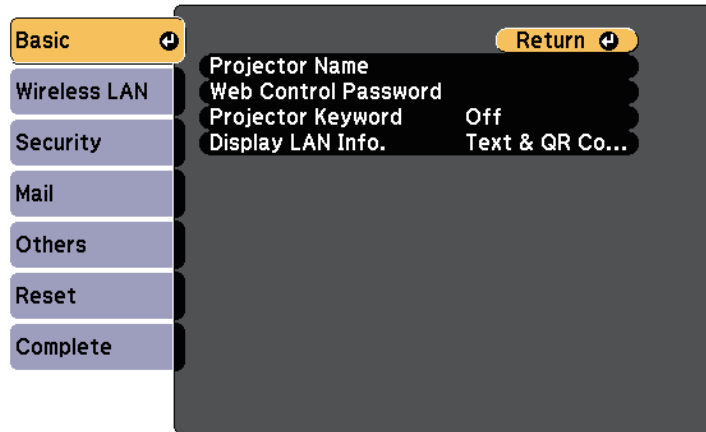

6 Select the basic options as necessary.

- **Projector Name** lets you enter a name up to 16 alphanumeric characters long to identify the projector over the network.
- **Web Control Password** lets you enter a password up to 8 alphanumeric characters long for accessing the projector over the Web. (Default user name is EPSONWEB; default password is admin.)
- **Projector Keyword** lets you turn on a security password to prevent access to the projector by anyone not in the room with it. You must enter a displayed, randomized keyword from a computer using the EasyMP Network Projection software to access the projector.



Use the displayed keyboard to enter the name, passwords and keyword. Press the arrow buttons on the remote control to highlight characters and press [Enter] to select them.

7 Select the **Wireless LAN** menu and press [Enter].

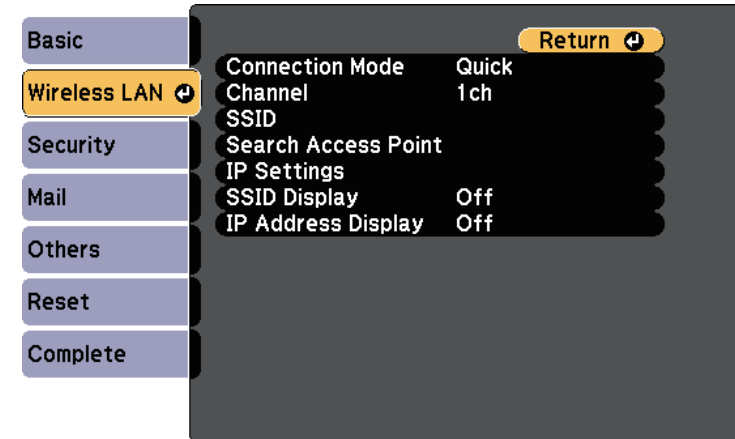

8 Select the **Connection Mode** setting.

- **Quick** lets you quickly connect to one computer.
- **Advanced** lets you connect to computers over a wireless network access point.

9 If you selected the **Advanced** connection mode, select **Search Access Point** to select the access point you want to connect to.



If you need to assign the SSID manually, select **SSID** to enter the SSID.

10 For the **Advanced** connection mode, assign the IP settings for your network as necessary.

- If your network assigns addresses automatically, select **IP Settings** to set the **DHCP** setting to **On**.
- If you must set addresses manually, select **IP Settings** to set the **DHCP** setting to **Off**, and then enter the projector's **IP Address**, **Subnet Mask**, and **Gateway Address** as necessary.

- 11** To prevent the SSID or IP address from being displayed on the standby screen, set the **SSID Display** setting or the **IP Address Display** setting to **Off**.
- 12** When you have finished selecting settings, select **Complete** and then follow the on-screen instructions to save your settings and exit the menus.
- 13** Press the [LAN] button on the remote control.
The wireless network settings are complete when you see the correct IP address on the LAN standby screen.

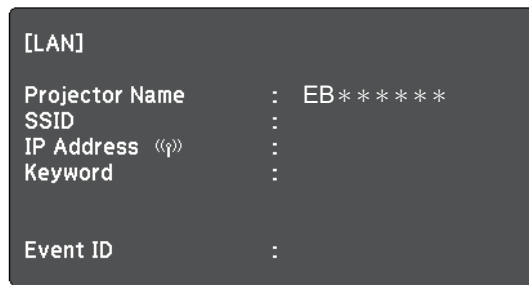

When you have finished making wireless settings for your projector, you need to select the wireless network on your computer. Then start the network software to send images to your projector through a wireless network.



If you use the EasyMP Network Projection software, make sure you select the connection mode that matches the projector's connection mode you selected.

Selecting Wireless Network Settings in Windows

Before connecting to the projector, select the correct wireless network on your computer.

- 1** To access your wireless utility software, double-click the network icon on the Windows taskbar.
- 2** When connecting in Advanced connection mode, select the network name (SSID) of the network the projector is connecting to.
- 3** Click **Connect**.

Selecting Wireless Network Settings in OS X

Before connecting to the projector, select the correct wireless network in OS X.

- 1** Click the AirPort icon on the menu bar at the top of the screen.
- 2** When connecting in Advanced connection mode, make sure AirPort is turned on and select the network name (SSID) of the network the projector is connecting to.

Setting Up Wireless Network Security

You can set up security for your projector to use on a wireless network. Set up one of the following security options to match the settings used on your network:

- WPA2-PSK security
- WPA/WPA2-PSK security



Contact your network administrator for guidance on entering the correct information.

- 1** Press the [Menu] button on the control panel or remote control.
- 2** Select the **Network** menu and press [Enter].

3 Select **Network Configuration** and press [Enter].

4 Select the **Security** menu and press [Enter].

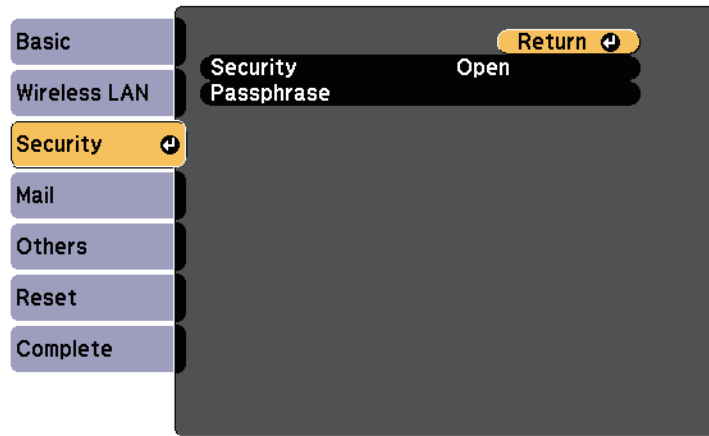

5 Select the security settings to match your network settings.

6 When you have finished making settings, select **Complete** and follow the on-screen instructions to save your settings and exit the menus.

» Related Links

- "Network Menu - Security Menu" [p.111](#)

After selecting the wireless network settings for your projector, you can display a QR code on the screen and use it to connect a mobile device using the Epson iProjection app.



- Make sure you have installed the latest version of Epson iProjection (V1.3.0 or later) on your device.
- You can download Epson iProjection for free from the App Store or from Google play. Any fees incurred when communicating with the App Store or Google play are the responsibility of the customer.
- You need to setup a Wi-Fi profile when using Epson iProjection for iOS for the first time.

1 Press the [Menu] button on the control panel or remote control.

2 Select the **Network** menu and press [Enter].

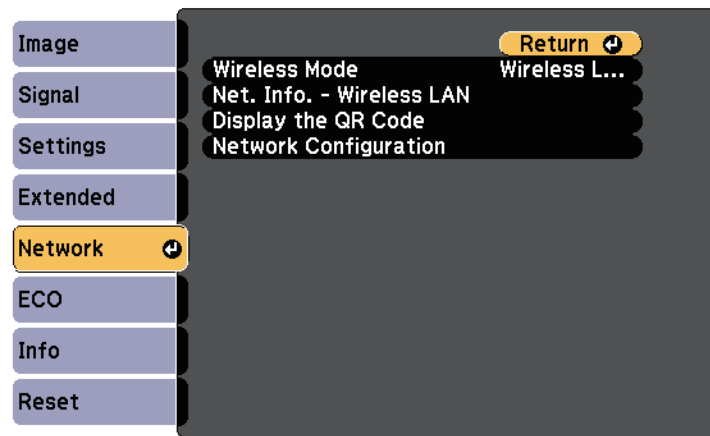

3 Select **Network Configuration** and press [Enter].

4 Select the **Basic** menu and press [Enter].

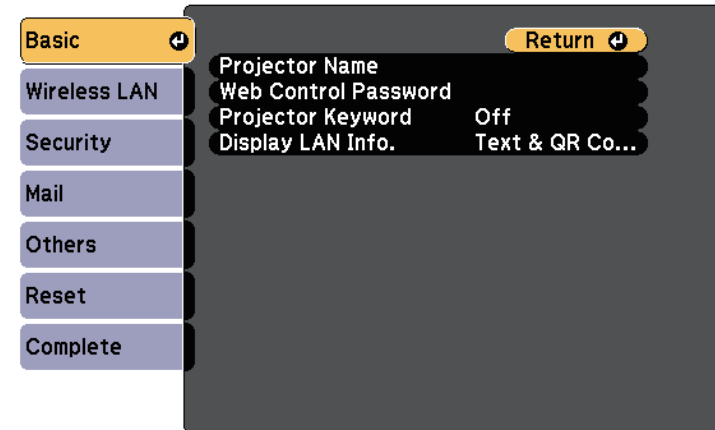

5 Set the **Display LAN Info.** setting to **Text & QR Code**.

6 Select **Complete** and then follow the on-screen instructions to save your settings and exit the menus.

7 Press the [LAN] button on the remote control or select **Display the QR Code** in the projector's Network menu.

The QR code is displayed on the projected surface.



If you do not see the QR code after pressing the [LAN] button, press [Enter] to display the code.

8 Start Epson iProjection on your mobile device.

9 Read the projected QR code with your mobile device to connect it to the projector.



To correctly read the QR code, make sure you face the screen squarely and closely enough so that the projected code fits into the guide of the mobile device's QR code reader. If you are too far from the screen, the code may not be read.

When a connection is established, the image from the mobile device is displayed. Tap Files on the application screen, and then select the file you want to project.

You can use the Quick Wireless Connection USB Key to quickly connect the projector to a Windows computer wirelessly and project your presentation.



The Quick Wireless Connection USB Key is not included with your projector.

- 1** Make sure the wireless LAN module is installed or built into your projector.
- 2** Turn on the projector.
- 3** Press the [LAN] button on the remote control.
The LAN standby screen is displayed. Verify that an SSID and IP address are displayed.
- 4** Do one of the following to connect the Quick Wireless Connection USB Key.
 - Remove the wireless LAN module from the projector and insert the Quick Wireless Connection USB Key into the same port used for the wireless LAN module (EB-W31/EB-X36/EB-X31/EB-S31/EB-U04/EB-W04/EB-X04/EB-S04/EB-U130/EB-W130/EB-X130/EB-S130/EB-X350/EB-X300/EB-S300).
 - Connect the Quick Wireless Connection USB Key to the projector's USB-A port (EB-U32/EB-W32).

You see a projected message that the network information update is complete.

- 5** Remove the Quick Wireless Connection USB Key.
If your projector needs the wireless LAN module, reinsert the wireless LAN module into the projector.
- 6** Connect the Quick Wireless Connection USB Key to a USB port on your computer.



In Windows Vista, if the AutoPlay window is displayed, select **Run LaunchQWRD.exe**, then select **Allow**.

- 7** Follow the on-screen instructions to install the Quick Wireless Connection driver.



If the Windows Firewall message is displayed, click **Yes** to disable the firewall.

After a few minutes, your computer image is displayed by the projector. If it does not appear, press the [LAN] button on your projector's remote control or restart your computer.

- 8** Run your presentation.
- 9** When you have finished projecting wirelessly, select the **Safely Remove Hardware** option in the Windows taskbar, and then remove the Quick Wireless Connection USB Key from your computer.



You may need to restart your computer to reactivate your wireless LAN connection.

Monitoring and Controlling the Projector

Follow the instructions in these sections to monitor and control the projector over a network.

► Related Links

- "EasyMP Monitor" [p.91](#)
- "Controlling a Networked Projector Using a Web Browser" [p.92](#)
- "Setting Up Projector Network E-Mail Alerts" [p.94](#)
- "Setting Up Monitoring Using SNMP" [p.95](#)
- "Using ESC/VP21 Commands" [p.96](#)

EasyMP Monitor software (Windows only) lets you monitor and control your projector through the network. See the *EasyMP Monitor Operation Guide* for instructions.

You can download EasyMP Monitor from the following Web site.

<http://www.epson.com/>

Once you have connected your projector to your network, you can select projector settings and control projection using a compatible Web browser. This lets you access the projector remotely.



- Make sure the computer and projector are connected to the network. When projecting images via a wireless LAN, connect in **Advanced** connection mode.
- The Web setup and control features support Internet Explorer 8.0 or later, and Safari on networks that do not use a proxy server for connection. Use Safari for OS X. You cannot select all of the projector menu settings or control all projector functions using a Web browser.
- If you set **Standby Mode to Communication On** in the projector's **ECO** menu, you can use a Web browser to select settings and control projection even if the projector is in standby mode (when the power is off).



- You cannot select the following settings using a Web browser. Test Pattern, Pointer Shape, User Button, User's Logo, Language, Reset Lamp Hours and all the settings in the **Network** menu
- You can select the following settings only using a Web browser.
 - SNMP Community Name (up to 32 alphanumeric characters)
 - Monitor Password (up to 16 alphanumeric characters)
 - HTTP port (port number used for Web Control except for 80 [default], 843, 3620, 3621, 3625, 3629, 4352, 4649, 5357, 10000, 10001, 41794)

- 1** Make sure the projector is turned on.
- 2** Start your Web browser on a computer connected to the network.
- 3** Type the projector's IP address into the browser's address box and press the computer's **Enter** key.

You see the Web Control screen.



- You may need to log in before you see the Web Control screen. If you see a log in window, enter your user name and password. (The default user name is **EPSONWEB** and the default password is **admin**.)
- You can change the password in the **Web Control Password** menu in the projector's **Network** menu.
 - **Network > Basic > Web Control Password**

- 4** To select projector menu settings, select the name of the menu and follow the on-screen instructions to select settings.

- 5** To control projection remotely, select the Web Remote option.



- 6** Select the icon corresponding to the projector function you want to control.

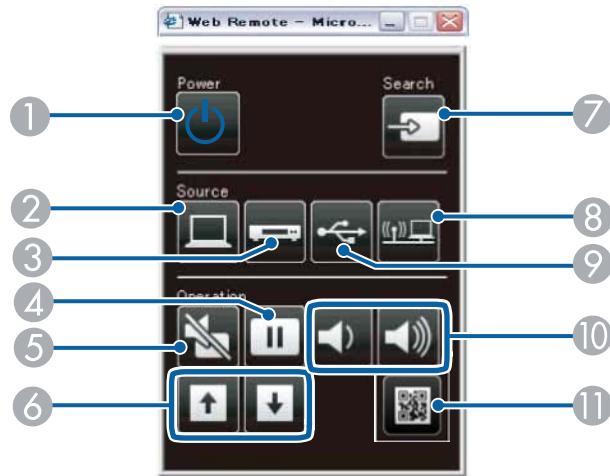

- ① Power button control
- ② Selects Computer port source
- ③ Selects S-Video, Video or HDMI/MHL port source
- ④ Freeze button control
- ⑤ A/V Mute button control
- ⑥ Page Up and Page Down button controls
- ⑦ Searches for sources
- ⑧ Selects the network source
- ⑨ Selects the USB Display or USB device source
- ⑩ Volume button controls
- ⑪ Displays the QR code



S-Video is available with the EB-W32/EB-W31/EB-X36/EB-X31/EB-S31/EB-W04/EB-X04/EB-S04/EB-W130/EB-X130/EB-S130/EB-X350/EB-X300/EB-S300.

» Related Links

- "Network Menu - Basic Menu" [p.109](#)
- "Projector Setup Settings - ECO Menu" [p.115](#)

You can set up the projector to send you an e-mail alert over the network if there is a problem with the projector.

If you set the **Standby Mode** setting to **Communication On** in the projector's **ECO** menu, you can receive the e-mail alerts even if the projector is in standby mode (when the power is off).

- 1 Press the [Menu] button on the control panel or remote control.
- 2 Select the **Network** menu and press [Enter].
- 3 Select **Network Configuration** and press [Enter].
- 4 Select the **Mail** menu and press [Enter].

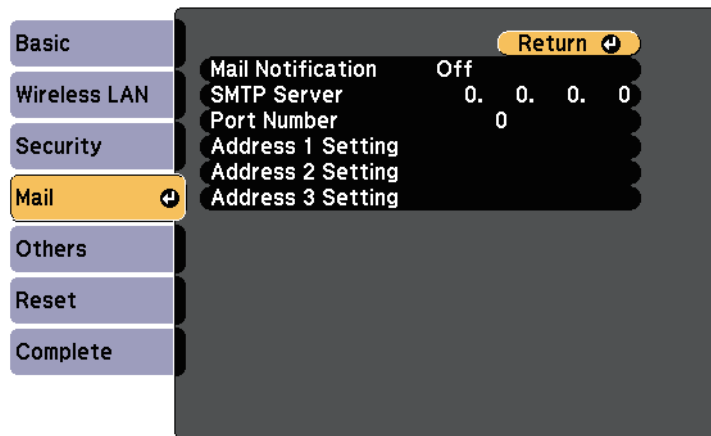

- 5 Set the **Mail Notification** setting to **On**.
- 6 Enter the IP address for the **SMTP Server** option.



Do not use these addresses: 127.x.x.x or 224.0.0.0 through 255.255.255.255 (where x is a number from 0 to 255).

- 7 Select a number for the SMTP server **Port Number**, from 1 to 65535 (default is 25).
- 8 Choose an address field, enter the e-mail address, and select the alerts you want to receive. Repeat for up to three addresses.



Your e-mail address can be up to 32 alphanumeric characters long.

- 9 When you finish selecting settings, select **Complete** and follow the on-screen instructions to save your settings and exit the menus.



If a critical problem causes a projector to shut down, you may not receive an e-mail alert.

► Related Links

- "Network Projector E-mail Alert Messages" [p.94](#)
- "Projector Setup Settings - ECO Menu" [p.115](#)

Network Projector E-mail Alert Messages

When a problem occurs with a projector on the network, and you selected to receive e-mail alerts, you receive an e-mail containing the following information:

- Address for Address 1 as the mail sender
- **Epson Projector** in the subject line
- The name of the projector experiencing a problem
- The IP address of the affected projector
- Detailed information about the problem

Network administrators can install SNMP (Simple Network Management Protocol) software on network computers so they can monitor projectors. If your network uses this software, you can set up the projector for SNMP monitoring.

- 1** Press the [Menu] button on the control panel or remote control.
- 2** Select the **Network** menu and press [Enter].
- 3** Select **Network Configuration** and press [Enter].
- 4** Select the **Others** menu and press [Enter].

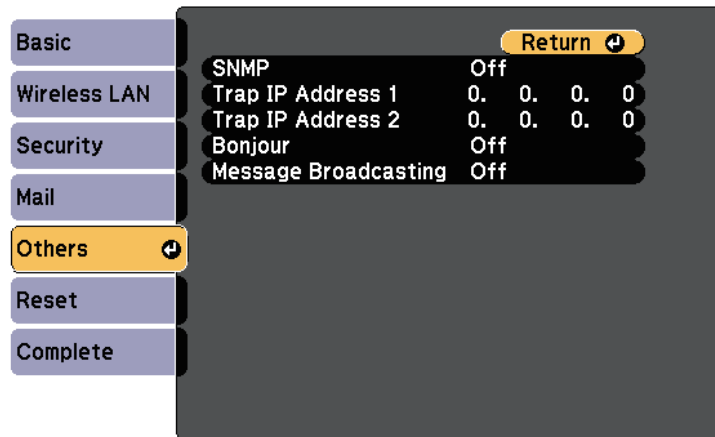

- 7** When you have finished selecting settings, select **Complete** and follow the on-screen instructions to save your settings and exit the menus.

- 5** Set the **SNMP** setting to **On**.
- 6** Enter up to two IP addresses to receive SNMP notifications, using 0 to 255 for each address field.



Do not use these addresses: 127.x.x.x or 224.0.0.0 through 255.255.255.255 (where x is a number from 0 to 255).

You can monitor and control the projector from a computer via USB. Connect the computer and the projector with a USB cable, and enter the communication commands (ESC/VP21 commands).

► **Related Links**

- "Setting Up for Using ESC/VP21 Commands" [p.96](#)
- "ESC/VP21 Command List" [p.96](#)
- "Communications Protocol" [p.96](#)

Setting Up for Using ESC/VP21 Commands

The first time you control and monitor the projector using ESC/VP21 commands, you must install the USB communication driver on your computer and set up the projector. You do not need to install the driver the next time.

- 1** Install the USB communication driver (EPSON USB-COM Driver) on your computer. For information about the EPSON USB-COM Driver, contact Epson.
- 2** Set the **USB Type B** setting to **Link 21L** in the projector's **Extended** menu.
- 3** Connect your computer to the projector's USB-B port using a USB cable.

You can start from step 2 the next time you use the commands.

ESC/VP21 Command List

When the power ON command is transmitted to the projector, the power turns on and it enters warm-up mode. When the projector's power has turned on, a colon ":" (3Ah) is returned.

When a command is input, the projector executes the command and returns a ":", and then accepts the next command.

If the command being processed terminates abnormally, an error message is output and a ":" is returned.

The following commands are available.

Item			Command
Power On/Off	On		PWR ON
	Off		PWR OFF
Signal selection	Computer	Auto	SOURCE 1F
		RGB	SOURCE 11
		Component	SOURCE 14
	HDMI, HDMI1		SOURCE 30
	HDMI2 *		SOURCE A0
	Video		SOURCE 41
	S-Video **		SOURCE 42
	USB Display		SOURCE 51
	USB		SOURCE 52
	LAN		SOURCE 53
A/V Mute On/Off	On		MUTE ON
	Off		MUTE OFF

* HDMI2 is available only with the EB-U32/EB-U04/EB-U130.

** S-Video is available only with the EB-W32/EB-W31/EB-X36/EB-X31/EB-S31/EB-W04/EB-X04/EB-S04/EB-W130/EB-X130/EB-S130/EB-X350/EB-X300/EB-S300.

Add a Carriage Return (CR) code (0Dh) to the end of each command and transmit.

Contact Epson for more details.

Communications Protocol

- Default baud rate setting: 9600 bps

- Data length: 8 bit
- Parity: None
- Stop-bit: 1 bit
- Flow control: None

Adjusting the Menu Settings

Follow the instructions in these sections to access the projector menu system and change projector settings.

► Related Links

- "Using the Projector's Menus" [p.99](#)
- "Using the On-screen Keyboard" [p.100](#)
- "Image Quality Settings - Image Menu" [p.101](#)
- "Input Signal Settings - Signal Menu" [p.103](#)
- "Projector Feature Settings - Settings Menu" [p.105](#)
- "Projector Setup Settings - Extended Menu" [p.107](#)
- "Projector Network Settings - Network Menu" [p.109](#)
- "Projector Setup Settings - ECO Menu" [p.115](#)
- "Projector Information Display - Info Menu" [p.116](#)
- "Projector Reset Options - Reset Menu" [p.118](#)
- "Copy Menu Settings to Another Projector (Batch Setup)" [p.119](#)

You can use the projector's menus to adjust the settings that control how your projector works. The projector displays the menus on the screen.

- 1 Press the [Menu] button on the control panel or remote control.

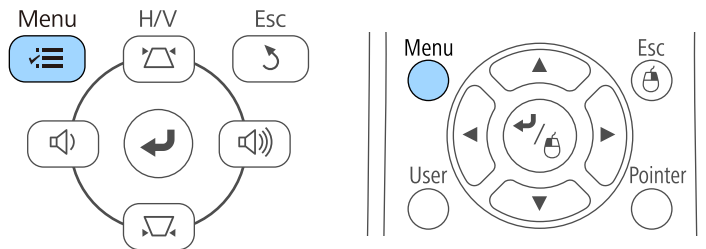

You see the menu screen displaying the **Image** menu settings.

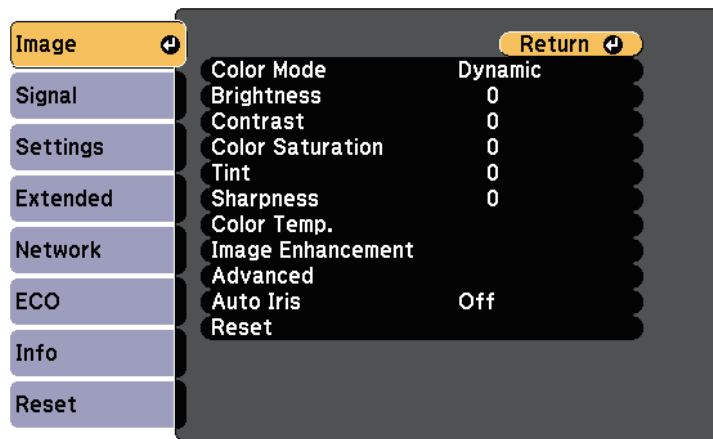

- 2 Press the up or down arrow buttons to move through the menus listed on the left. The settings for each menu are displayed on the right.





The available settings depend on the current input source.

- 3 To change settings in the displayed menu, press [Enter].
- 4 Press the up or down arrow button to move through the settings.
- 5 Change the settings using the buttons listed on the bottom of the menu screens.
- 6 To return all the menu settings to their default values, select **Reset**.
- 7 When you finish changing settings on a menu, press [Esc].
- 8 Press [Menu] or [Esc] to exit the menus.

The on-screen keyboard is displayed when you need to enter numbers and characters.

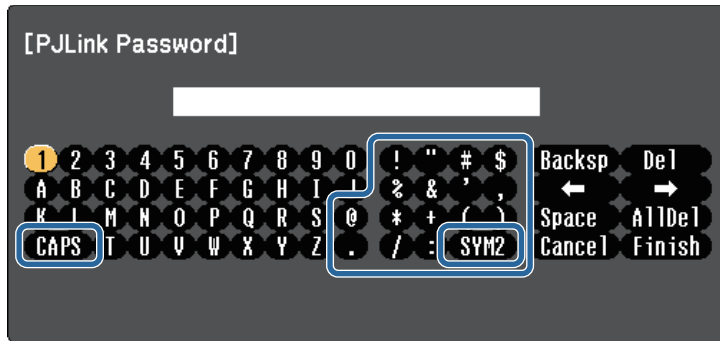
- 1 Use the arrow buttons on the control panel or remote control to highlight the number or character you want to enter and press the [Enter] button.



 Each time you select the **CAPS** key, the characters change between upper case and lower case. Each time you select the **SYM1/2** key, the symbols enclosed by the frame change.

- 2 After entering the text, select **Finish** on the keyboard to confirm your entries. Select **Cancel** to cancel entering text.

» **Related Links**

- "Available Text Using the On-screen Keyboard" [p.100](#)
- "Controlling a Networked Projector Using a Web Browser" [p.92](#)

Available Text Using the On-screen Keyboard

You can enter the following text when using the on-screen keyboard.

Text type	Details
Alphabet	ABCDEFGHIJKLMNOPQRSTUVWXYZ abcdefghijklmnopqrstuvwxyz
Symbols	!"#\$%&'()*+,-./:;<=>?@[\] ^_`{ }~

Text type	Details
Numbers	0123456789

Settings on the **Image** menu let you adjust the quality of your image for the input source you are currently using. The available settings depend on the currently selected input source.

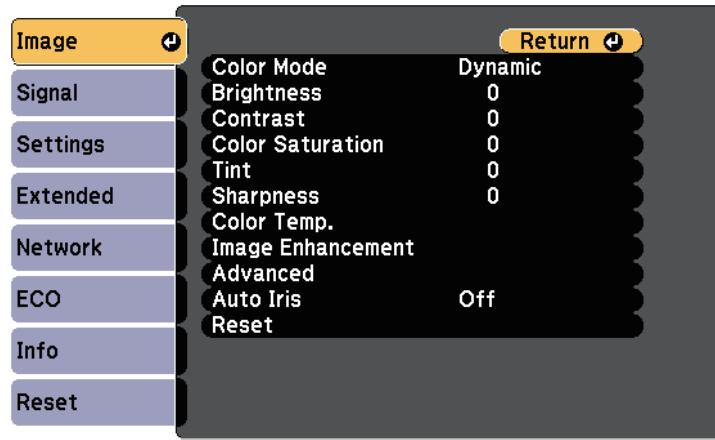

To change settings for an input source, make sure the source is connected and select that source.

Setting	Options	Description
Color Mode	See the list of available Color Modes	Adjusts the vividness of image colors for various image types and environments.
Brightness	Varying levels available	Lightens or darkens the overall image.
Contrast	Varying levels available	Adjusts the difference between light and dark areas of the image.
Color Saturation	Varying levels available	Adjusts the intensity of the image colors.
Tint	Varying levels available	Adjusts the balance of green to magenta tones in the image.
Sharpness	Varying levels available	Adjusts the sharpness or softness of image details.

Setting	Options	Description
Color Temp.	Color Temp. Customized	Sets the color tone based on color temperature. The image is tinted blue when a high value is selected and tinted red when a low value is selected. Color Temp.: select to set the color temperature range from 3200K to 10000K (for sRGB mode) or from 0 to 10 (for other color modes). Customized: adjusts the individual R (red), G (green), and B (blue) components of the offset and gain.
Image Enhancement	Noise Reduction	Reduces flickering in analog images.
Advanced	Deinterlacing (For interlaced signal [480i/576i/1080i] input)	Sets whether or not to convert interlaced-to-progressive signals for certain video image types. Off: for fast-moving video images. Video: for most video images. Film/Auto: for movies, computer graphics, and animation.
Auto Iris	Off Normal High Speed	Adjusts the projected luminance based on the image brightness when the Color Mode is set to Dynamic or Cinema .
Reset	—	Resets all adjustment values except Color Mode on the Image menu to their default settings.



- The **Brightness** setting does not affect lamp brightness. To change the lamp brightness mode, use the **Power Consumption** setting in the projector's **ECO** menu.
- You cannot select the **Noise Reduction** setting when the following are being input.
 - The **Deinterlacing** setting is set to **Off**.
 - A digital RGB signal is being input.
 - An interlaced signal (480i/576i/1080i) is being input.

» Related Links

- "Available Color Modes" [p.53](#)

Normally the projector automatically detects and optimizes the input signal settings. If you need to customize the settings, you can use the **Signal** menu. The available settings depend on the currently selected input source.

 You cannot select settings on the **Signal** menu when the current input source is one of the following:

- USB Display
- USB
- LAN

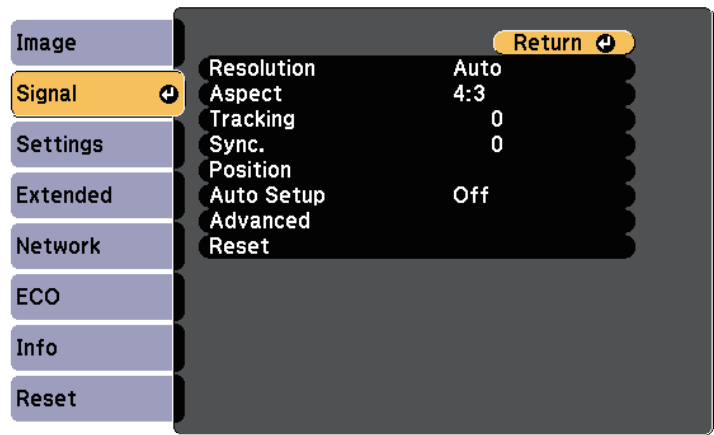

 You can restore the default settings of the **Tracking**, **Sync.**, and **Position** settings by pressing the [Auto] button on the remote control.

To change settings for an input source, make sure the source is connected and select that source.

Setting	Options	Description
Aspect	See the list of available aspect ratios.	Sets the aspect ratio (width-to-height ratio) for the selected input source.
Tracking	Varying levels available	Adjusts the signal to eliminate vertical stripes in computer images.
Sync.	Varying levels available	Adjusts the signal to eliminate fuzziness or flickering in computer images.
Position	Up Down Left Right	Adjusts the image location on the screen.
Auto Setup	On Off	Automatically optimizes computer image quality (when On).
Overscan (For component video and RGB video signal input)	Auto Off 4% 8%	Changes the projected image ratio to make the edges visible by a selectable percentage or automatically.

Setting	Options	Description
Resolution	Auto Normal Wide	Sets the input signal resolution if not detected automatically using the Auto option.



Setting	Options	Description
Advanced	HDMI Video Range Input Signal Video Signal	<p>HDMI Video Range: Sets the video range to match the setting of the device connected to the HDMI input port.</p> <ul style="list-style-type: none"> • Auto: detects the video range automatically. • Normal: normally for images from a device other than a computer; can also be selected if the black areas of the image are too bright. • Expanded: normally for images from a computer; can also be selected if the image is too dark. <p>Input Signal: Specifies the signal type from the input sources connected to the computer ports.</p> <ul style="list-style-type: none"> • Auto: detects signals automatically. • RGB: corrects color for computer/RGB video inputs. • Component: corrects color for component video inputs. <p>Video Signal: Specifies the signal type from the input sources connected to the video ports.</p> <p>Auto: detects signals automatically. If interference appears or no image appears when set to Auto, select the appropriate signal according to the connected equipment.</p>
Reset	—	<p>Resets all adjustment values on the Signal menu to their default settings, except for the following:</p> <ul style="list-style-type: none"> • Input Signal

» **Related Links**

- "Available Image Aspect Ratios" [p.51](#)

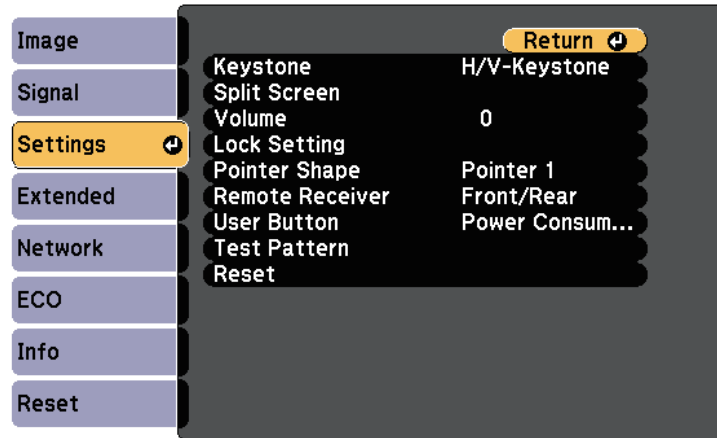
Options on the **Settings** menu let you customize various projector features.



Setting	Options	Description
Volume	Varying levels available	Adjusts the volume of projector's speaker system. Setting values are saved for each source.
Lock Setting	Control Panel Lock	Controls projector button locking to secure the projector: Full Lock: locks all buttons. Partial Lock: locks all buttons except the power button. Off: no buttons locked.
Pointer Shape	Pointer 1:  Pointer 2:  Pointer 3: 	Changes the shape of the remote control pointer.
Remote Receiver	Front/Rear Front Rear Off	Limits reception of remote control signals by the selected receiver; Off turns off all receivers.
User Button	Power Consumption Info Deinterlacing Test Pattern Resolution Display the QR Code	Assigns a menu option to the [User] button on the remote control for one-touch access.

Setting	Options	Description
Keystone	H/V-Keystone Quick Corner	Adjusts image shape to rectangular (horizontally and vertically). H/V-Keystone: select to manually correct horizontal and vertical sides, or turn Auto V-Keystone and H-Keystone Adjuster on or off. Quick Corner: select to correct image shape and alignment using an on-screen display.
Split Screen	Screen Size Source Swap Screens Audio Source Display the QR Code	Divides the viewing area horizontally and displays two images side-by-side (press [Esc] to cancel split screen display).
Zoom (EB-S31/EB-S04/EB-S130/EB-S300)	—	Adjusts the size of the projected image.

Setting	Options	Description
Test Pattern	—	<p>Displays a test pattern to assist in focusing and zooming the image and correcting image shape (press the [Esc] button to cancel pattern display).</p> <div data-bbox="667 432 1055 587" style="border: 1px solid black; background-color: #ffffcc; padding: 5px;"><p>Attention If a pattern is displayed for a long time, a residual image may be visible in projected images.</p></div>
Reset	—	<p>Resets all adjustment values on the Settings menu to their default settings, except for the following:</p> <ul style="list-style-type: none">• Zoom• User Button

Settings on the **Extended** menu let you customize various projector setup features.

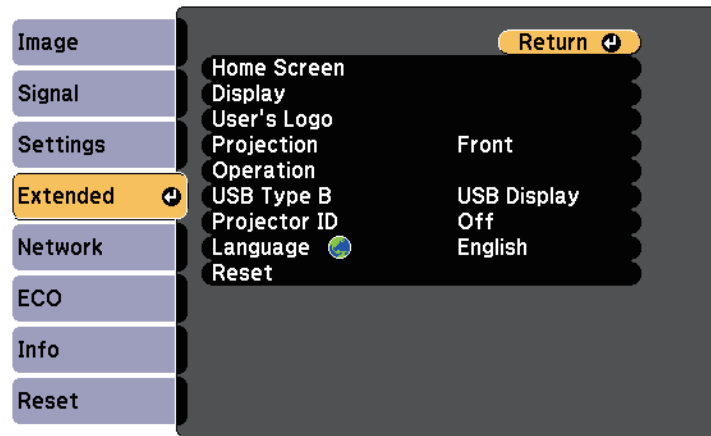

Setting	Options	Description
Display	Messages Display Background Startup Screen A/V Mute	Selects various display options: Messages: set to On to display messages such as input source name, color mode name, aspect ratio, no signal message, or high temperature warning on your projected image. Display Background: sets the screen color or logo to display when no signal is received. Startup Screen: set to On to display the user's logo when projection starts. A/V Mute: sets the screen color or logo to display when A/V Mute is turned on.
User's Logo	—	Creates a screen that the projector displays to identify itself and enhance security.
Projection	Front Front/Ceiling Rear Rear/Ceiling	Selects the way the projector faces the screen so the image is oriented correctly.

Setting	Options	Description
Home Screen	Home Screen Auto Disp. Custom Function 1 Custom Function 2	Selects the projector's Home screen display options: Home Screen Auto Disp.: select whether or not to display the Home screen automatically. Custom Function 1/Custom Function 2: select to set functions and the display as the customized Home screen.

Setting	Options	Description
Operation	Direct Power On High Altitude Mode Auto Source Search Auto Power On	<p>Selects various operation options:</p> <p>Direct Power On: lets you turn on the projector by plugging it in without pressing the power button.</p> <p>High Altitude Mode: regulates the projector's operating temperature at altitudes above 1500 m.</p> <p>Auto Source Search: set to On to detect the input signal automatically and project images when there is no input signal.</p> <p>Auto Power On: select the image source from which you want to automatically start projection. When the projector detects the input signal from the selected image source, it projects automatically in standby mode. To enable this feature, connect the projector using a VGA computer cable or USB cable.</p>
USB Type B	USB Display Link 21L	<p>USB Display: enables the USB Display.</p> <p>Link 21L: enables ESC/VP21 commands.</p>
Projector ID	Off 1 through 9	Assigns an ID for the projector when you use multiple projectors.
Language	Various languages available	Select the language for projector menu and message displays.
Reset	—	<p>Resets all adjustment values on the Extended menu to their default settings, except for the following:</p> <ul style="list-style-type: none"> • User's Logo • Projection • High Altitude Mode • Auto Source Search • USB Type B • Projector ID • Language



When you set **User's Logo Protection** to **On** in the **Password Protection** screen, you cannot change settings related to user's logo display (**Display Background**, **Startup Screen**, **A/V Mute** in the **Display** setting). Set **User's Logo Protection** to **Off** first.

» **Related Links**

- "Selecting Password Security Types" [p.77](#)

Settings on the **Network** menu let you view network information and set up the projector for monitoring and controlling over a network.

When you set **Network Protection** to **On** in the **Password Protection** screen, you cannot change the network settings. Set **Network Protection** to **Off** first.

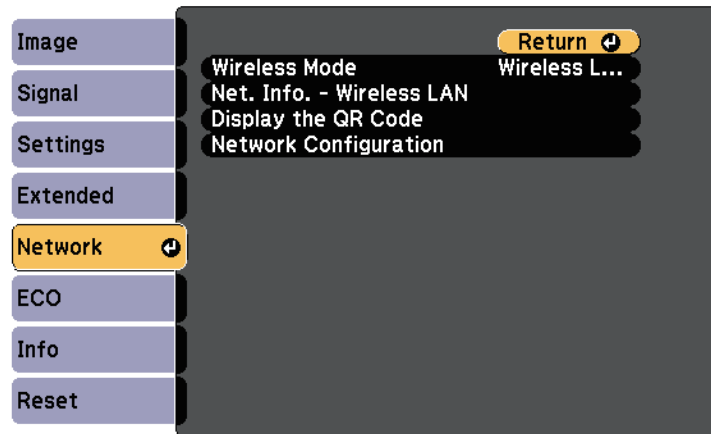

Setting	Options	Description
Net. Info. - Wireless LAN	Connection Mode Wireless LAN Sys. Antenna Level Projector Name SSID DHCP IP Address Subnet Mask Gateway Address MAC Address Region Code	Displays wireless network status and details when you have selected Wireless Mode to Wireless LAN On .
Display the QR Code	—	Displays the QR code.
Network Configuration	To additional network menus	Configures your network settings.

Setting	Options	Description
Wireless Mode	Wireless LAN On Off	Configures your wireless LAN settings. Select Wireless LAN On when connecting the projector and a computer over a wireless LAN. If you do not want to connect via wireless LAN, turn it off to prevent unauthorized access by others.

 Once you have connected your projector to your network, you can select projector settings and control projection using a compatible Web browser. This lets you access the projector remotely.

» **Related Links**

- "Network Menu - Basic Menu" [p.109](#)
- "Network Menu - Wireless LAN Menu" [p.110](#)
- "Network Menu - Security Menu" [p.111](#)
- "Network Menu - Mail Menu" [p.112](#)
- "Network Menu - Others Menu" [p.113](#)
- "Network Menu - Reset Menu" [p.113](#)
- "Selecting Password Security Types" [p.77](#)

Network Menu - Basic Menu

Settings on the **Basic** menu let you select the basic network settings.

☛ Network > Network Configuration > Basic

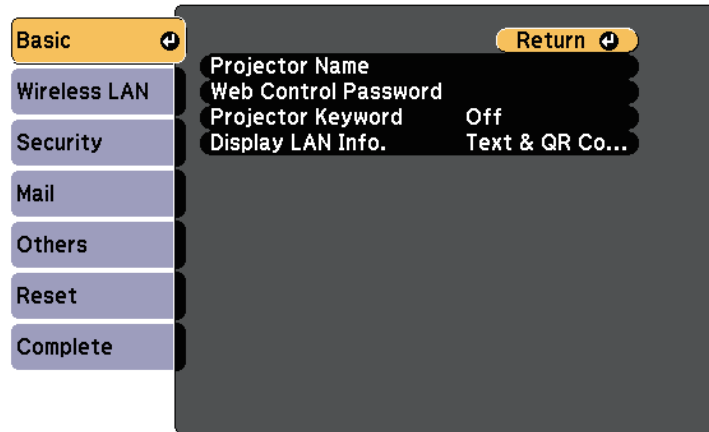

Setting	Options	Description
Display LAN Info.	Text & QR Code Text	Set the display format for the projector's network information. When a QR code is displayed, you can connect to the network by simply reading the QR code with Epson iProjection. The default value is Text & QR Code .

Network Menu - Wireless LAN Menu

Settings on the **Wireless LAN** menu let you select the wireless LAN settings.

☛ Network > Network Configuration > Wireless LAN

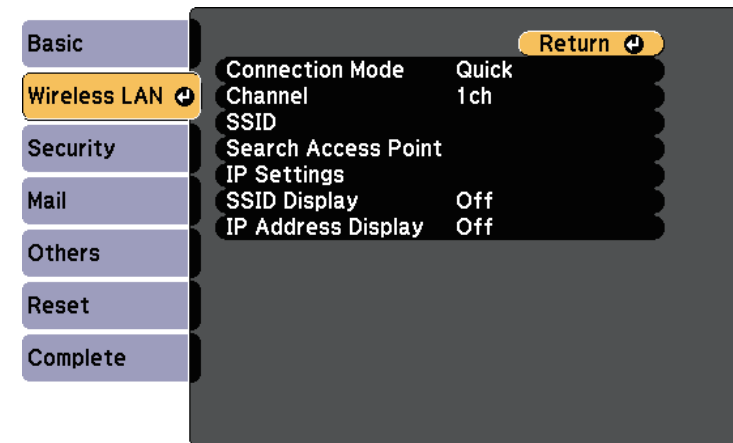

Setting	Options	Description
Projector Name	Up to 16 alphanumeric characters (do not use " * + , / ; < = > ? [\] ' ` spaces)	Enter a name to identify the projector over the network.
Web Control Password	Up to 8 alphanumeric characters (do not use * : spaces)	Enter a password for accessing the projector over the Web. (Default user name is EPSONWEB; default password is admin.)
Projector Keyword	On Off	Set to On to enable a security password to prevent access to the projector by anyone not in the room with it. You must enter a displayed, randomized keyword from a computer using the EasyMP Network Projection and EasyMP Multi PC Projection software to access the projector.

Setting	Options	Description
Connection Mode	Quick Advanced	Select the type of wireless connection: Quick: lets you quickly connect to one computer. The projector becomes an easy access point. Select the type of security and set passphrase in the Security menu as necessary to use EasyMP Network Projection to connect in Quick connection mode. Advanced: lets you connect to multiple computers over a wireless network access point. The connection is established in infrastructure mode.
Channel	1ch 6ch 11ch	In Quick connection mode, selects the frequency band (channel) used by the wireless LAN.
SSID	Up to 32 alphanumeric characters	Sets the SSID (network name) of the wireless LAN system the projector is connecting to.
Search Access Point	To Search View	Search for available wireless network access points in Advanced connection mode. Depending on the access point settings, they may not be displayed in the list. You must set security separately.
IP Settings	DHCP IP Address Subnet Mask Gateway Address	DHCP: set to On if your network assigns addresses automatically; set to Off to manually enter the network's IP Address , Subnet Mask , and Gateway Address using 0 to 255 for each address field. Do not use these addresses: 0.0.0.0, 127.x.x.x or 224.0.0.0 through 255.255.255.255 (where x is a number from 0 to 255) for IP Address and Gateway Address and 0.0.0.0 and 255.255.255.255 for Subnet Mask.

Setting	Options	Description
SSID Display	On Off	Select whether to display the SSID on the network standby screen.
IP Address Display	On Off	Select whether to display the IP address on the network standby screen.

Network Menu - Security Menu

Settings on the **Security** menu let you select the type of security and security settings that match the network you are connecting the projector to.

☛ **Network > Network Configuration > Security**

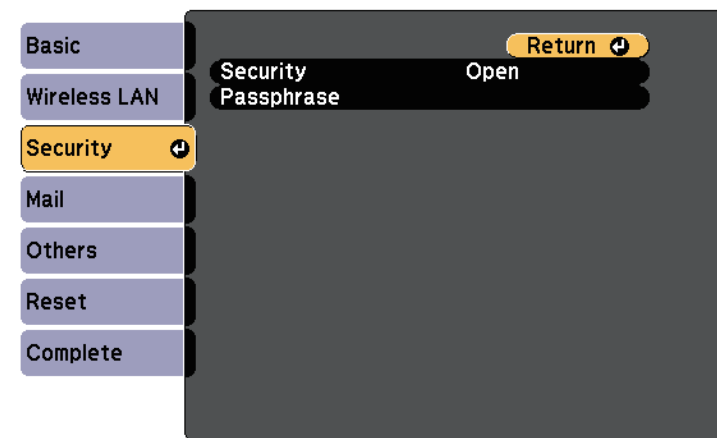

Setting	Options	Description
Security	Open WPA2-PSK WPA/WPA2-PSK	Selects the type of security used on the wireless network. When setting security, follow the instructions from the administrator of the network system you want to connect to.

Setting	Options	Description
Passphrase	Various passphrases from 8 to 32 characters (when entering from a Web browser: various passphrases from 8 to 63 characters)	For WPA2-PSK and WPA/WPA2-PSK security, selects the pre-shared passphrase used on the network. When the passphrase is entered and the [Enter] button is pressed, the value is set and displayed as an asterisk (*). When connecting using EasyMP Network Projection, you do not need to input the passphrase on the computer if the passphrase has not been changed from the default. We recommend changing the passphrase periodically for security. If the network settings are initialized, it returns to the initial passphrase.

Type of security

When connecting to a wireless network in Advanced connection mode, it is strongly recommended that you set security.

WPA is an encryption standard that improves the security for wireless networks. The projector supports TKIP and AES encryption methods.

WPA also includes user authentication functions. WPA authentication provides two methods: using an authentication server, or authenticating between a computer and an access point without using a server. This projector supports the latter method, without a server.



For setting details, follow the instructions from your network administrator.

Network Menu - Mail Menu

Settings on the **Mail** menu let you receive an email notification if a problem or warning occurs in the projector.

Network > Network Configuration > Mail

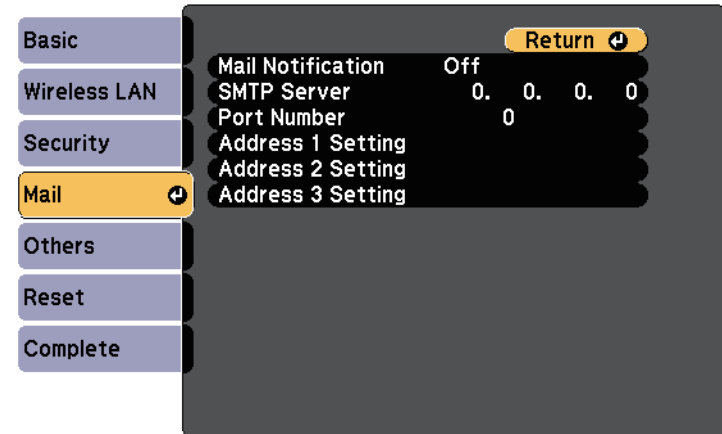

Setting	Options	Description
Mail Notification	On Off	Set to On to send an email to the preset addresses when a problem or warning occurs with a projector.
SMTP Server	IP address	Enter the IP address for the projector's SMTP server using 0 to 255 for each address field. Do not use these addresses: 127.x.x.x or 224.0.0.0 through 255.255.255.255 (where x is a number from 0 to 255).
Port Number	1 to 65535 (default is 25)	Select a number for the SMTP server Port Number.
Address 1 Setting Address 2 Setting Address 3 Setting	Up to 32 alphanumeric characters (do not use " () , ; ; < > [\] spaces)	Enter the e-mail address, and select the alerts you want to receive. Repeat for up to 3 addresses.

Network Menu - Others Menu

Settings on the **Others** menu let you select other network settings.

☛ **Network > Network Configuration > Others**

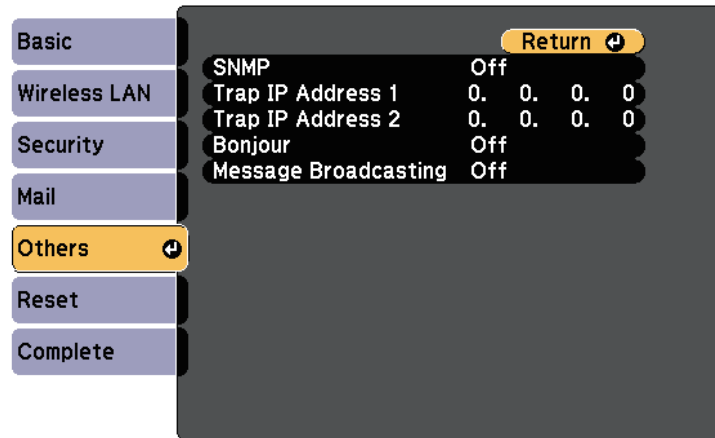

Setting	Options	Description
Bonjour	On Off	Set to On when connecting to the network using Bonjour. See Apple's Web site for more information on the Bonjour service. http://www.apple.com/
Message Broadcasting	On Off	Set to On to enable EPSON Message Broadcasting feature. You can download Message Broadcasting and its Operation Guide from the following Web site. http://www.epson.com/

Network Menu - Reset Menu

Settings on the **Reset** menu let you reset all of the network settings.

☛ **Network > Network Configuration > Reset**

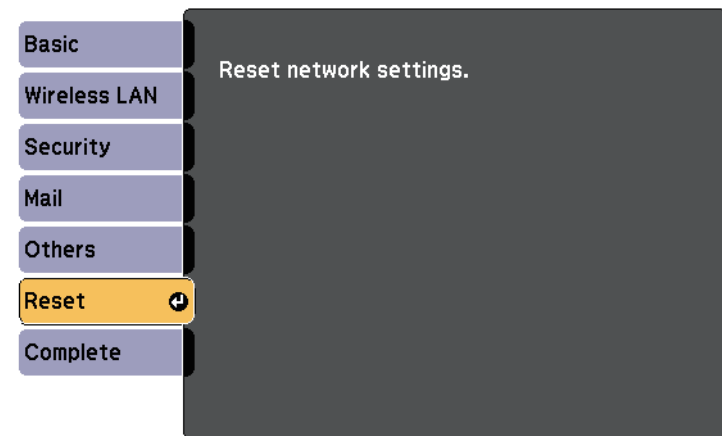

Setting	Options	Description
SNMP	On Off	Set to On to monitor the projector using SNMP. To monitor the projector, you need to install the SNMP manager program on your computer. SNMP should be managed by a network administrator. The default value is Off .
Trap IP Address 1 Trap IP Address 2	IP address	Enter up to two IP addresses to receive SNMP notifications, using 0 to 255 for each address field. Do not use these addresses: 127.x.x.x or 224.0.0.0 through 255.255.255.255 (where x is a number from 0 to 255).

Setting	Options	Description
Reset network settings.	Yes No	Select Yes to reset all network settings.

Settings on the **ECO** menu let you customize projector functions to save power.

When you select a power-saving setting, a leaf icon appears next to the menu item.

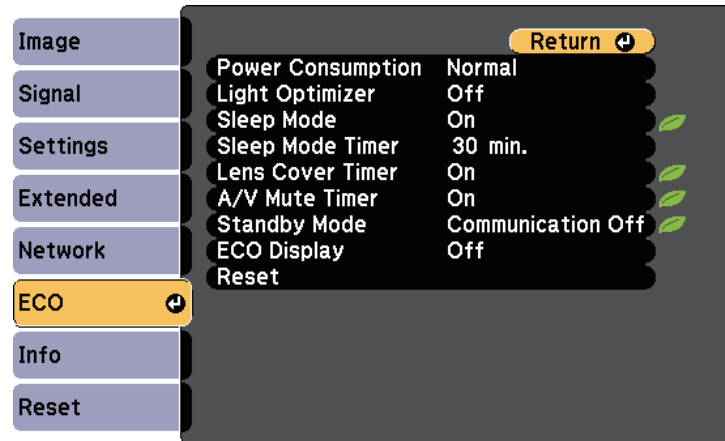

Setting	Options	Description
Power Consumption	Normal ECO	Selects the brightness mode of the projector lamp: Normal: sets maximum lamp brightness. ECO: reduces lamp brightness and fan noise, and saves power and lamp life. You cannot select settings when you use your projector at high altitude or in locations subject to high temperatures.
Light Optimizer (Available when Power Consumption is set to Normal .)	On Off	When set to On , the lamp brightness is adjusted according to the projected image. This helps to reduce the power consumption by lowering the lamp brightness according to the scene being projected. The setting is stored for each Color Mode.

Setting	Options	Description
Sleep Mode	On Off	Automatically turns off the projector after an interval of inactivity (when On).
Sleep Mode Timer	1 to 30 minutes	Sets the interval for Sleep Mode.
Lens Cover Timer	On Off	Automatically turns off the projector after 30 minutes if the lens cover is closed (when On).
A/V Mute Timer	On Off	Automatically turns off the projector after 30 minutes if A/V Mute is enabled (when On).
Standby Mode	Communication On Communication Off	Communication On indicates that the projector can be monitored over a network when the projector is in standby mode. Enable this setting to allow the following operations to occur when the projector is in standby mode: <ul style="list-style-type: none"> Monitor and control the projector over a network
ECO Display	On Off	Displays a leaf icon in the bottom left corner of the projected screen to indicate the power-saving status when the lamp brightness changes (when On).
Reset	—	Resets all adjustment values on the ECO menu to their default settings, except for Standby Mode .



- When the **Sleep Mode Timer** setting is enabled, the lamp dims for a short time before the timer limit is reached and the projector turns off.
- When the **Lens Cover Timer** or **A/V Mute Timer** settings are enabled, the lamp uses less power when the lens cover is closed or **A/V Mute** is activated.

» **Related Links**

- "Projector Setup Settings - Extended Menu" [p.107](#)

You can display information about the projector and version by viewing the **Info** menu. However, you cannot change any settings in the menu.

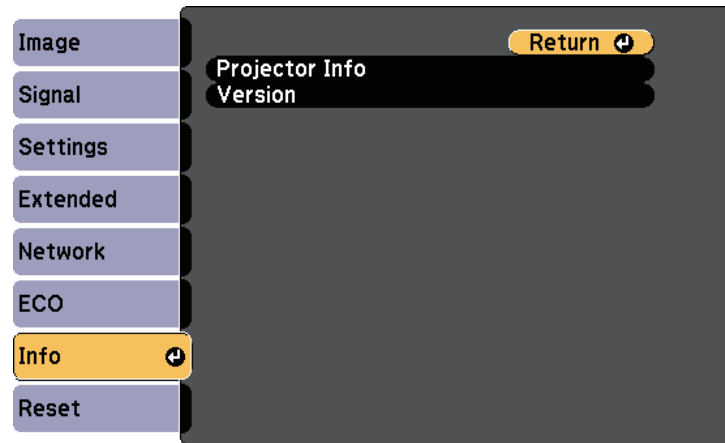

Info Menu - Projector Info Menu

You can display information about the projector and input sources by viewing the **Projector Info** menu in the projector's **Info** menu.

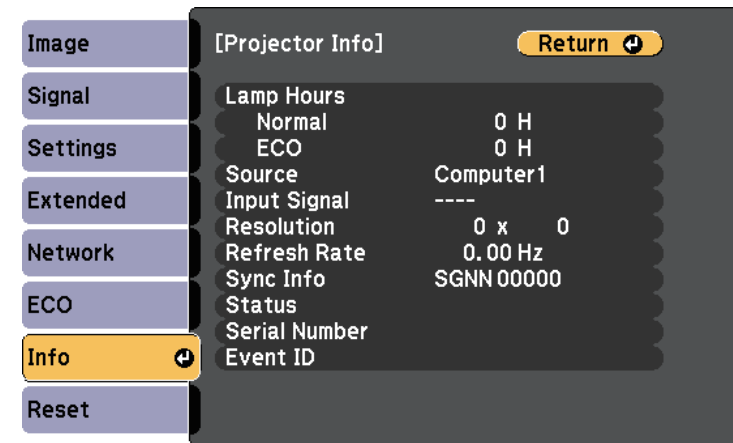

Information item	Description
Projector Info	Displays the projector information.
Version	Displays the projector's firmware version.

» Related Links

- "Info Menu - Projector Info Menu" [p.116](#)



The available settings depend on the current input source. The lamp usage timer does not register any hours until you have used the lamp for at least 10 hours.

Information item	Description
Lamp Hours	Displays the number of hours (H) the lamp has been used in Normal and ECO Power Consumption modes; if the information is displayed in yellow, obtain a genuine Epson replacement lamp soon.
Source	Displays the name of the port to which the current input source is connected.
Input Signal	Displays the input signal setting of the current input source.
Resolution	Displays the resolution of the current input source.

Information item	Description
Video Signal	Displays the video signal format of the current input source.
Refresh Rate	Displays the refresh rate of the current input source.
Sync Info	Displays information that may be needed by a service technician.
Status	Displays information about projector problems that may be needed by a service technician.
Serial Number	Displays the projector's serial number.
Event ID	Displays the Event ID number corresponding to a specific projector problem; see the list of Event ID codes.

» **Related Links**

- "Event ID Code List" [p.117](#)

Event ID Code List

If the **Event ID** option on the **Info** menu displays a code number, check this list of Event ID codes for the solution to the projector problem associated with the code.

If you cannot resolve the problem, contact your network administrator or Epson for technical support.

Event ID code	Cause and solution
0432	The network software did not start. Turn the projector off and then on again.
0435	
0434	Unstable network communication. Check the network communication status, wait a few moments, and try connecting to the network again.
0481	
0482	
0485	
0433	Cannot display the transferred images. Restart the network software.

Event ID code	Cause and solution
0484	Communication with computer was disconnected. Restart the network software.
0483	The network software quit unexpectedly. Check the network communication status, then turn the projector off and then on again.
04FE	
0479	A projector system error has occurred. Turn the projector off and then on again.
04FF	
0891	Cannot find an access point with the same SSID. Set your computer, access point, and projector to the same SSID.
0892	The WPA/WPA2 authentication type does not match. Make sure the wireless network security settings are correct.
0893	The TKIP/AES encryption type does not match. Make sure the wireless network security settings are correct.
0894	Communication with an unauthorized access point was disconnected. Contact your network administrator.
0898	Failed to acquire DHCP. Make sure the DHCP server is operating correctly. If you are not using DHCP, set the DHCP setting to Off in the projector's Network menu.  Network > Wireless LAN > IP Settings > DHCP
0899	Other communication errors.

You can reset most of the projector settings to their default values using the **Reset All** option on the **Reset** menu.

You can also reset the projector's lamp usage timer to zero when you replace the lamp using the **Reset Lamp Hours** option.

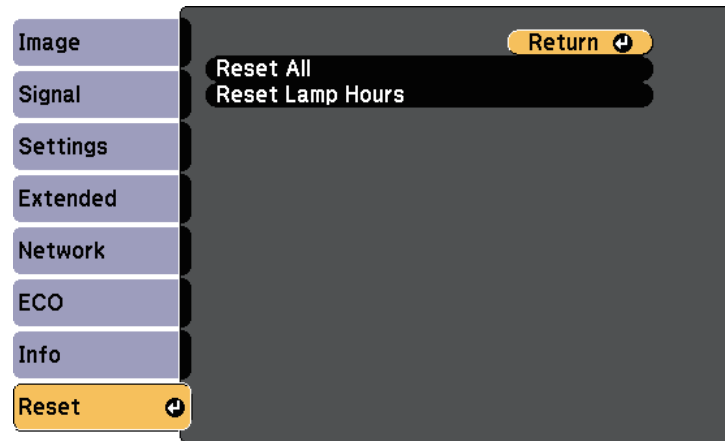

You cannot reset the following settings using the **Reset All** option:

- Input Signal
- Zoom
- User's Logo
- Language
- **Network** menu items
- Lamp Hours
- Password

After selecting the projector's menu settings for one projector, you can save the settings to a USB flash drive or a computer connected with a USB cable to copy settings to another projector, as long as they are the same model.

Menu settings such as the following are not copied to the other projector.

- **Network** menu settings (except for the **Mail** menu and the **Others** menu)
- **Lamp Hours** and **Status** from the **Info** menu



Perform batch setup before adjusting the image settings such as Keystone. Since image adjustment values are also copied to another projector, the adjustments you made before performing the batch setup are overwritten and the projected screen you adjusted may change.

When copying the menu settings from one projector to another, user's logo is also copied. Do not register the information that you do not want to share between multiple projector as a user's logo.

Caution

Epson takes no responsibility for batch setup failures and associated repair costs due to power outages, communication errors, or other problems that may cause such failures.

» Related Links

- "Performing Batch Setup Using a USB Flash Drive" [p.119](#)
- "Performing Batch Setup Using a USB Cable" [p.120](#)

Performing Batch Setup Using a USB Flash Drive

You can copy menu settings from one projector to another of the same model using a USB flash drive.



The USB flash drive must use a FAT format and not incorporate any security function. Delete any files on the drive before using it for batch setup or the settings may not be saved correctly.

- 1** Disconnect the power cord from the projector, and check that all of the projector's indicators have turned off.

- 2** Connect an empty USB flash drive directly to the projector's USB-A port.

- 3** Hold down the [Esc] button on the remote control or the control panel and connect the power cord to the projector.

- 4** When all of the projector's indicators turn on, release the [Esc] button. The indicators start flashing and the batch setup file is written to the USB flash drive. When writing is finished, the projector turns off.

Caution

Do not disconnect the power cord or the USB flash drive from the projector while the file is being written. If the power cord or USB flash drive is disconnected, the projector may not start correctly.

- 5** Remove the USB flash drive.



The file name for the batch setup file is PJCONFDATA.bin. If you need to change the file name, add text after PJCONFDATA using only alphanumeric characters. If you change the PJCONFDATA section of the file name, the projector may not be able to recognize the file correctly.

- 6** Disconnect the power cord from the projector to which you want to copy settings, and check that all of the projector's indicators have turned off.

- 7** Connect the USB flash drive containing the saved batch setup file to the projector's USB-A port.

- 8** Hold down the [Menu] button on the remote control or the control panel and connect the power cord to the projector.

- 9** When all of the projector's indicators turn on, release the [Menu] button. (The indicators remain on for approximately 75 seconds.)

When all of the indicators start flashing, the settings are being written. When writing is finished, the projector turns off.

Caution

Do not disconnect the power cord or the USB flash drive from the projector while the file is being written. If the power cord or drive is disconnected, the projector may not start correctly.

- 10 Remove the USB flash drive.

Performing Batch Setup Using a USB Cable

You can copy menu settings from one projector to another of the same model by connecting the computer and projector with a USB cable.



You can use this batch setup method with the following operating system versions:

- Windows Vista and later
- OS X 10.5.3 and later

- 1 Disconnect the power cord from the projector, and check that all of the projector's indicators have turned off.
- 2 Connect a USB cable to the computer's USB port and to the projector's USB-B port.
- 3 Hold down the [Esc] button on the remote control or the control panel and connect the power cord to the projector.
- 4 When all of the projector's indicators turn on, release the [Esc] button. The computer recognizes the projector as a removable disk.
- 5 Open the removable disk icon or folder, and save the batch setup file to the computer.



The file name for the batch setup file is PJCONFDATA.bin. If you need to change the file name, add text after PJCONFDATA using only alphanumeric characters. If you change the PJCONFDATA section of the file name, the projector may not be able to recognize the file correctly.

- 6 Eject the USB device (Windows) or drag the removable disk icon to the Trash (OS X).
 - 7 Disconnect the USB cable. The projector turns off.
 - 8 Disconnect the power cord from the projector to which you want to copy settings, and check that all of the projector's indicators have turned off.
 - 9 Connect the USB cable to the computer's USB port and to the projector's USB-B port.
 - 10 Hold down the [Menu] button on the remote control or the control panel and connect the power cord to the projector.
 - 11 When all of the projector's indicators turn on, release the [Menu] button. The computer recognizes the projector as a removable disk.
 - 12 Copy the batch setup file (PJCONFDATA.bin) that you saved to your computer to the top level folder of the removable disk.
- 
- Do not copy any files or folders other than the batch setup file to the removable disk.
- 13 Eject the USB device (Windows) or drag the removable disk icon to the Trash (OS X).

- 14** Disconnect the USB cable.
 When all of the indicators start flashing, the settings are being written.
 When writing is finished, the projector turns off.

⚠ Caution

Do not disconnect the power cord from the projector while the file is being written. If the power cord is disconnected, the projector may not start correctly.

» **Related Links**

- "Batch Setup Error Notification" [p.121](#)

Batch Setup Error Notification

The projector's indicators notify you if an error occurs during a batch setup operation. Check the status of the projector's indicators and follow the instructions described in the table here.

Indicator status	Problem and solution
<p> Status Lamp Temp </p> <ul style="list-style-type: none"> • Power: Blue - flashing fast • Status: Blue - flashing fast • Lamp: Orange - flashing fast • Temp: Orange - flashing fast 	<p>Writing the settings may have failed and an error may have occurred in the projector's firmware.</p> <p>Stop using the projector, remove the power plug from the electrical outlet. Contact Epson for help.</p>

Indicator status	Problem and solution
<p> Status Lamp Temp </p> <ul style="list-style-type: none"> • Lamp: Orange - flashing fast • Temp: Orange - flashing fast 	<p>The batch setup file may be corrupt, or the USB flash drive or USB cable may not be connected correctly.</p> <p>Disconnect the USB flash drive or the USB cable, unplug and then plug in the projector's power cord, and then try again.</p>

Maintaining the Projector

You may need to clean the projector's lens periodically, and clean the air filter and air vents to prevent the projector from overheating due to blocked ventilation. The only parts you should replace are the lamp, air filter, and remote control batteries. If any other part needs replacing, contact Epson or an authorized Epson servicer.

Warning

Before cleaning any part of the projector, turn it off and unplug the power cord. Never open any cover on the projector, except as specifically explained in this manual. Dangerous electrical voltages in the projector can injure you severely.

» Related Links

- "Cleaning the Lens" [p.123](#)
- "Cleaning the Projector Case" [p.124](#)
- "Air Filter and Vent Maintenance" [p.125](#)
- "Projector Lamp Maintenance" [p.127](#)
- "Replacing the Remote Control Batteries" [p.132](#)

Clean the projector's lens periodically, or whenever you notice dust or smudges on the surface.

- To remove dust or smudges, gently wipe the lens with lens-cleaning paper.
- To remove stubborn smudges, moisten a soft, lint-free cloth with lens cleaner and gently wipe the lens. Do not spray any liquid directly on the lens.

Warning

Do not use a lens cleaner that contains flammable gas. The high heat generated by the projector lamp may cause a fire.

Attention

Do not use glass cleaner or any harsh materials to clean the lens and do not subject the lens to any impacts; otherwise, it could be damaged. Do not use canned air, or the gases may leave a flammable residue.

Before cleaning the projector case, turn off the projector and unplug the power cord.

- To remove dust or dirt, use a soft, dry, lint-free cloth.
- To remove stubborn dirt, use a soft cloth moistened with water and mild soap. Do not spray liquid directly on the projector.

Attention

Do not use wax, alcohol, benzene, paint thinner, or other chemicals to clean the projector case. These can damage the case. Do not use canned air, or the gases may leave a flammable residue.

Regular filter maintenance is important to maintaining your projector. Clean the air filter when a message appears telling you the temperature inside the projector has reached a high level. It is recommended that you clean these parts at least once every three months. Clean them more often than this if you use the projector in a particularly dusty environment.

Attention

If regular maintenance is not performed, your Epson projector will notify you when the temperature inside the projector has reached a high level. Do not wait until this warning appears to maintain your projector filter as prolonged exposure to high temperatures may reduce the life of your projector or lamp.

► Related Links

- "Cleaning the Air Filter and Vents" [p.125](#)
- "Replacing the Air Filter" [p.125](#)

Cleaning the Air Filter and Vents

Clean the projector's air filter or vents if they get dusty, or if you see a message telling you to clean them.

- 1** Turn off the projector and unplug the power cord.
- 2** Gently remove the dust using a small vacuum designed for computers or a very soft brush (such as a paintbrush).

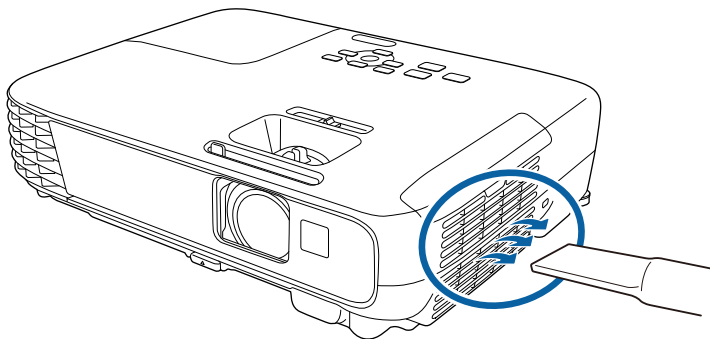

You can remove the air filter so that you can clean both sides. Do not rinse the air filter in water, or use any detergent or solvent to clean it.

Attention

Do not use canned air. The gases may leave a flammable residue or push dust and debris into the projector's optics or other sensitive areas.

- 3** If dust is difficult to remove or the air filter is damaged, replace the air filter.

Replacing the Air Filter

You need to replace the air filter in the following situations:

- After cleaning the air filter, you see a message telling you to clean or replace it
- The air filter is torn or damaged

You can replace the air filter while the projector is mounted to the ceiling or placed on a table.

- 1** Turn off the projector and unplug the power cord.

2 Open the air filter cover.

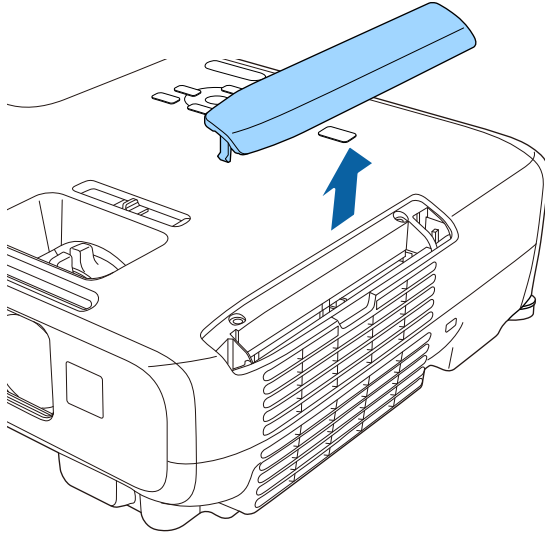

3 Grip the air filter tab and pull the air filter straight out.

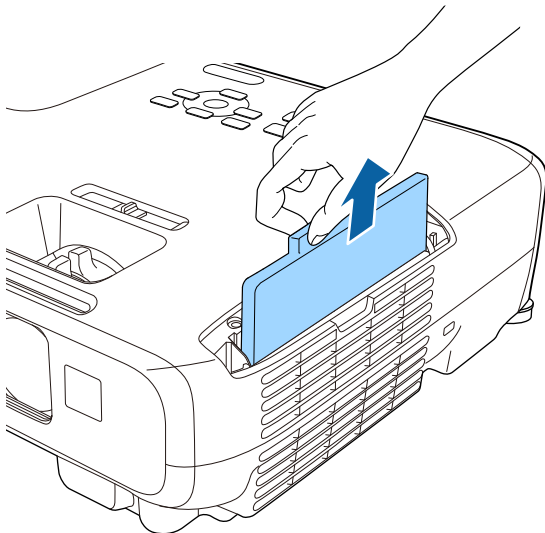

Dispose of used air filters according to local regulations.

- Filter frame: ABS
- Filter: Polyurethane foam

4 Place the new air filter in the projector as shown and push gently until it clicks into place.

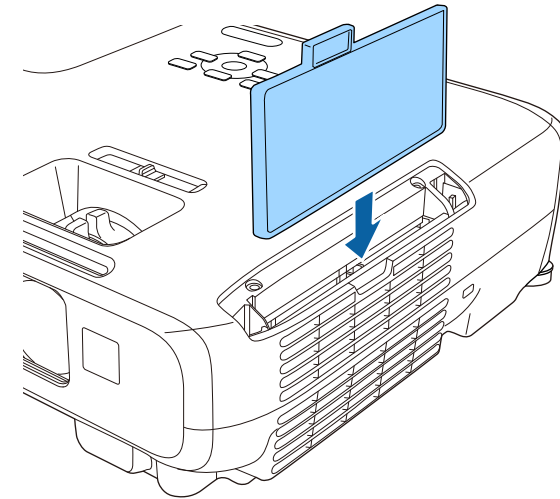

5 Close the air filter cover.

» **Related Links**

- "Replacement Parts" [p.148](#)

The projector monitors the number of hours the lamp is used and displays this information in the projector's menu system.

Replace the lamp as soon as possible when the following occurs:

- The projected image gets darker or quality declines
- A message is displayed when you turn on the projector telling you to replace the lamp (the message is displayed 100 hours before the expected end of the lamp life and appears for 30 seconds)

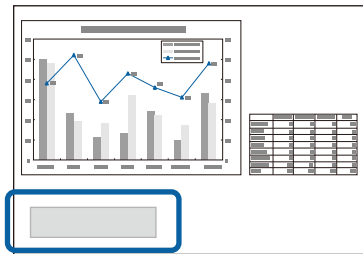

- The power indicator is flashing blue, and the projector's lamp indicator is flashing orange.

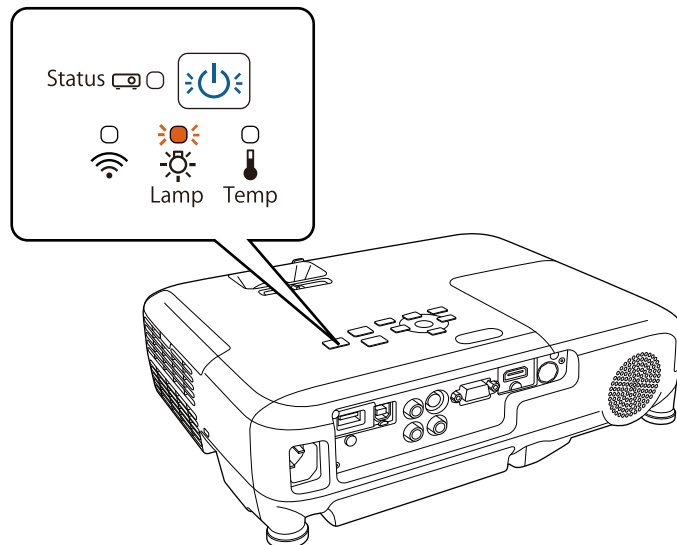

Attention

- If you continue to use the lamp after the replacement period has passed, the possibility that the lamp may explode increases. When the lamp replacement message appears, replace the lamp with a new one as soon as possible, even if it is still working.
- Do not repeatedly turn off the power and then immediately turn it back on. Turning the power on and off frequently may shorten the lamp's operating life.
- Depending on the characteristics of the lamp and the way it has been used, the lamp may become darker or stop working before the lamp warning message appears. You should always have a spare lamp unit ready in case it is needed.
- We recommend the use of genuine Epson replacement lamps. The use of non-genuine lamps may affect projection quality and safety. Any damage or malfunction caused by the use of non-genuine lamps may not be covered by Epson's warranty.

» Related Links

- "Replacing the Lamp" [p.127](#)
- "Resetting the Lamp Timer" [p.130](#)
- "Projector Specifications" [p.155](#)

Replacing the Lamp

You can replace the lamp while the projector is placed on a table or mounted to the ceiling.

⚠ Warning

- Let the lamp fully cool before replacing it to avoid injury.
- Never disassemble or modify the lamp. If a modified or disassembled lamp is installed in the projector, it could cause a fire, electric shock, or other damage or injury.

- 1** Turn off the projector and unplug the power cord.
- 2** Allow the projector lamp to cool down for at least one hour.
- 3** Use the screwdriver included with the replacement lamp to loosen the screw securing the lamp cover.

Warning

When replacing the lamp, there is a possibility that the lamp may be broken. If replacing the lamp of a projector which has been installed on the ceiling, you should always assume that the lamp is cracked, and you should stand to the side of the lamp cover, not underneath it. Remove the lamp cover gently. Be careful when removing the lamp cover as shards of glass may fall out and could cause an injury. If any shards of glass get into your eyes or mouth, contact a doctor immediately.

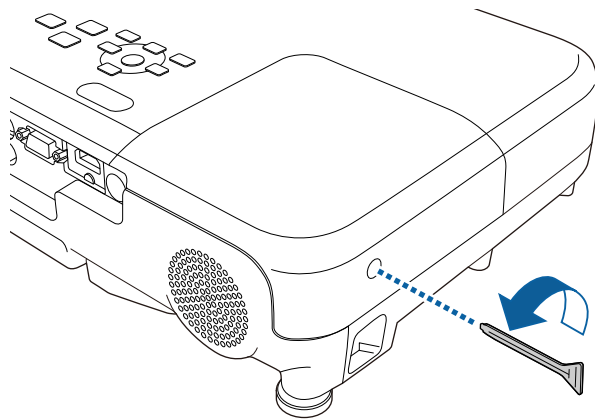

- 4** Slide the lamp cover out and lift it off.

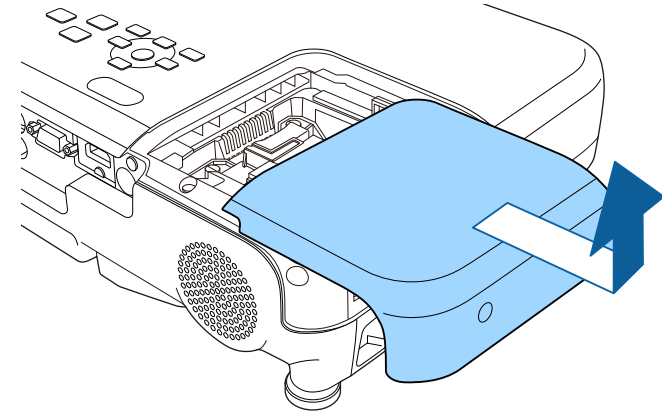

- 5** Loosen the screws securing the lamp to the projector. The screws do not come all the way out.

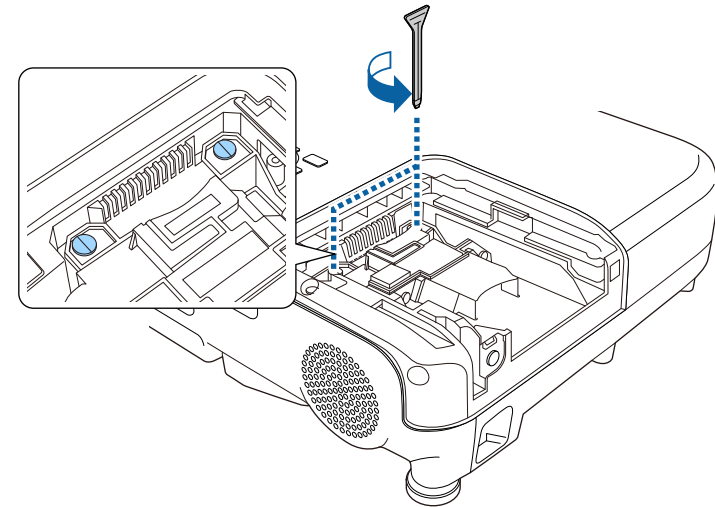

6 Grip the raised section of the lamp and remove it.

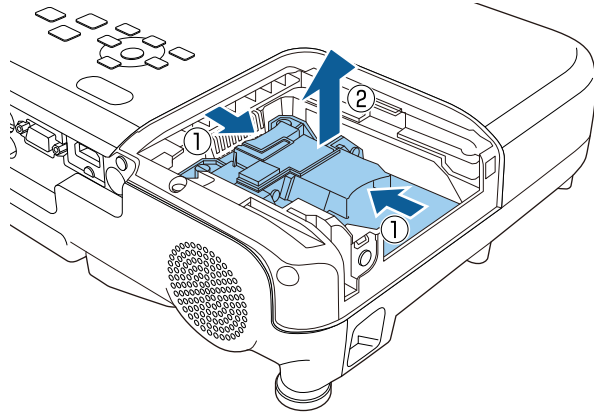

- If you notice the lamp is cracked when removing the lamp, contact Epson for help.
- The lamp(s) in this product contain mercury (Hg). Check your local laws and regulations regarding disposal or recycling. Do not put in the trash.

7 Gently insert the new lamp into the projector. If it does not fit easily, make sure it is facing the right way.

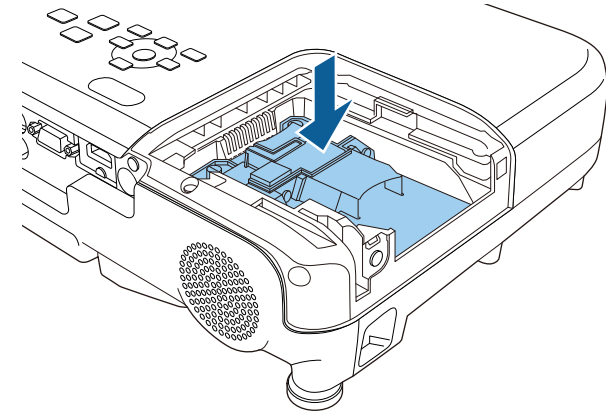

Attention

Do not touch any glass on the lamp assembly to avoid premature lamp failure.

- 8** Push in the lamp firmly and tighten the screws to secure it.

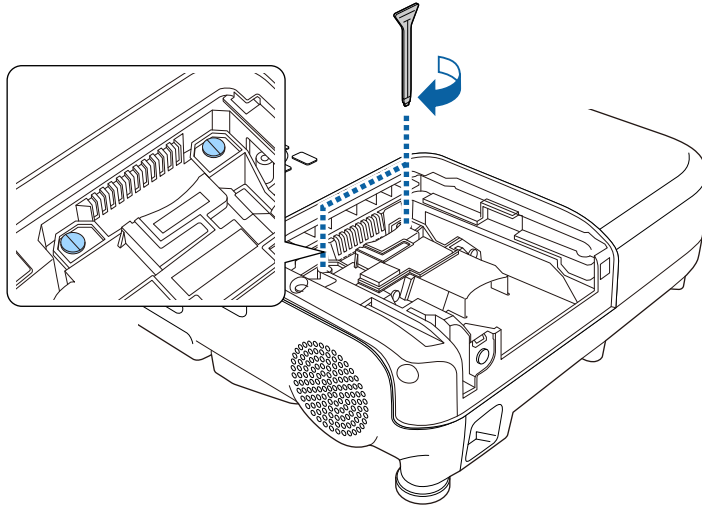

- 9** Replace the lamp cover and tighten the screw to secure it.

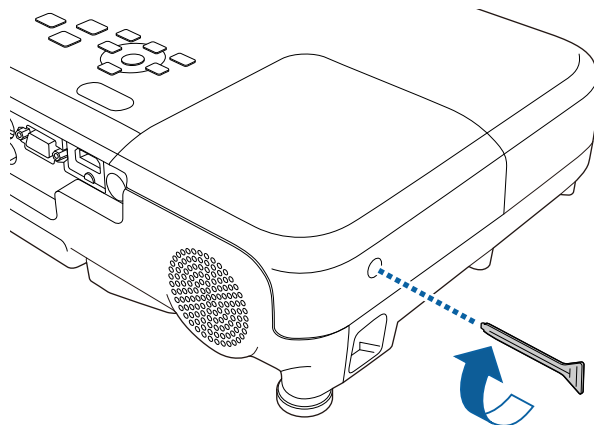

- Make sure the lamp cover is securely installed or the lamp will not turn on.
- Do not replace the lamp cover with too much force and make sure the lamp cover is not deformed.

Reset the lamp timer to zero to monitor the new lamp's usage.

► Related Links

- "Replacement Parts" [p.148](#)

Resetting the Lamp Timer

You must reset the lamp timer after replacing the projector's lamp to clear the lamp replacement message and to monitor lamp usage correctly.



Do not reset the lamp timer if you have not replaced the lamp to avoid inaccurate lamp usage information.

- 1** Turn on the projector.
- 2** Press the [Menu] button on the control panel or remote control.
- 3** Select the **Reset** menu and press [Enter].

- 4 Select **Reset Lamp Hours** and press [Enter].

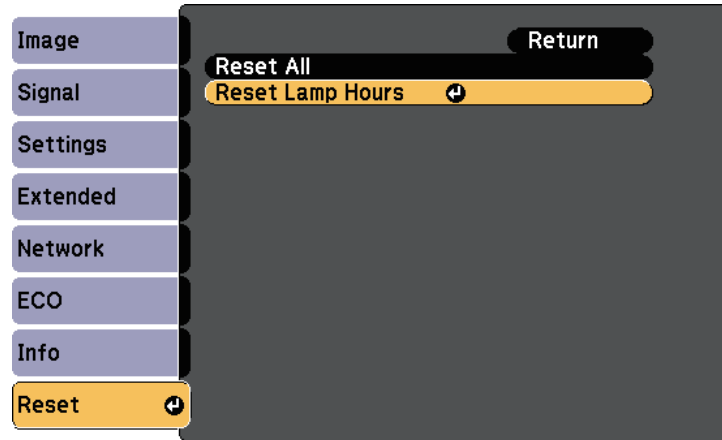

You see a prompt asking if you want to reset the lamp hours.

- 5 Select **Yes** and press [Enter].
- 6 Press [Menu] or [Esc] to exit the menus.

The remote control uses two AA manganese or alkaline batteries. Replace the batteries as soon as they run out.

Attention

Make sure you read the *Safety Instructions* before handling the batteries.

- 1 Open the battery cover as shown.

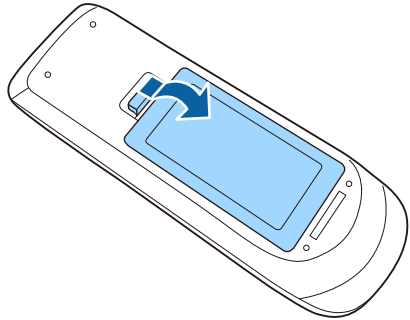

- 2 Remove the old batteries.

- 3 Insert the batteries with the + and - ends facing as shown.

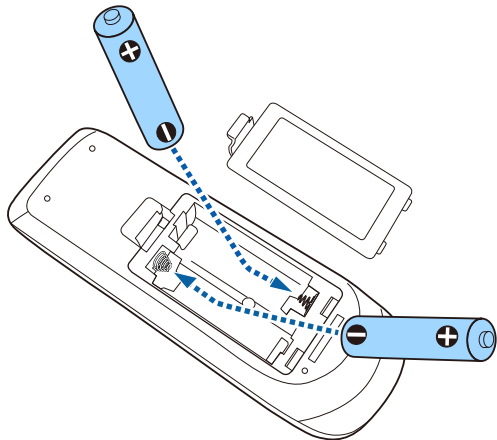

Warning

Check the positions of the (+) and (-) marks inside the battery holder to ensure the batteries are inserted the correct way. If the batteries are not used correctly, they could explode or leak causing a fire, injury, or damage to the product.

- 4 Close the battery cover and press it down until it clicks into place.

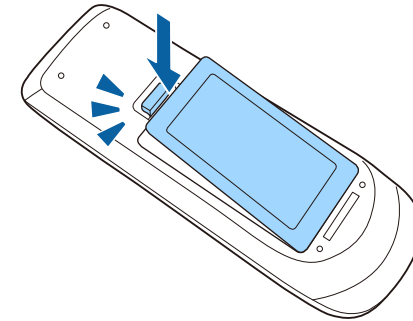

Solving Problems

Check the solutions in these sections if you have any problems using the projector.

► Related Links

- "Projection Problems" [p.134](#)
- "Projector Indicators Status" [p.135](#)
- "Using the Projector Help Displays" [p.137](#)
- "Solving Image or Sound Problems" [p.138](#)
- "Solving Projector or Remote Control Operation Problems" [p.144](#)
- "Solving Network Problems" [p.146](#)

If the projector is not working properly, turn it off, unplug it, and then plug it back in and turn it on.

If this does not solve the problem, check the following:

- The indicators on the projector may indicate the problem.
- The projector's Help system can display information about common problems.
- The solutions in this manual can help you solve many problems.

If none of these solutions help, contact Epson for technical support.

The indicators on the projector indicate the projector status and let you know when a problem occurs. Check the status and color of the indicators and then refer to this table for a solution.

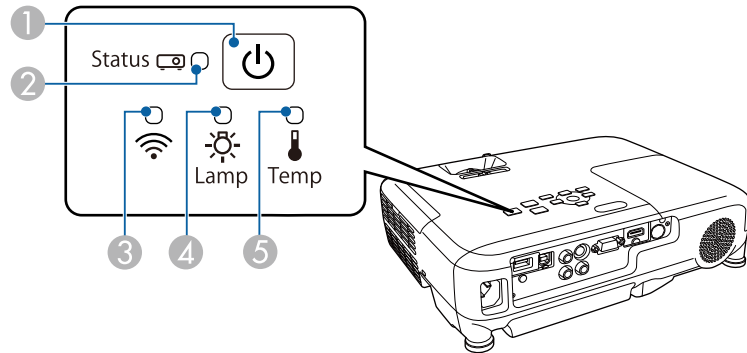

- ① Power indicator
- ② Status indicator
- ③ Wireless LAN indicator (operates only on EB-U32 and EB-W32)
- ④ Lamp indicator
- ⑤ Temp (temperature) indicator

Indicator and status	Problem and solutions
Power: Lit blue Status: Lit blue Lamp: Off Temp: Off	Normal operation.
Power: Lit blue Status: Flashing blue Lamp: Off Temp: Off	Warming up or shutting down. When warming up, wait about 30 seconds for an image to appear. All buttons are disabled during warm-up and shutting down.

Indicator and status	Problem and solutions
Power: Lit blue Status: Off Lamp: Off Temp: Off	Standby, sleep mode, or monitoring. When you press the power button, projection starts.
Power: Flashing blue Status: Off Lamp: Off Temp: Off	Preparing for monitoring and all features are disabled.
Power: Flashing blue Status: Indicator status varies Lamp: Indicator status varies Temp: Flashing orange	Projector is too hot. <ul style="list-style-type: none"> • Make sure that the vents and air filter are not clogged with dust or obstructed by nearby objects. • Clean or replace the air filter. • Make sure the environmental temperature is not too hot.
Power: Off Status: Flashing blue Lamp: Off Temp: Lit orange	Projector has overheated and turned off. Leave it turned off to cool down for 5 minutes. <ul style="list-style-type: none"> • Make sure that the vents and air filter are not clogged with dust or obstructed by nearby objects. • Clean or replace the air filter. • If operating the projector at high altitude, set the High Altitude Mode setting to On in the projector's Extended menu. <ul style="list-style-type: none"> ☛ Extended > Operation > High Altitude Mode • If the problem persists, unplug the projector and contact Epson for help.

Indicator and status	Problem and solutions
Power: Off Status: Flashing blue Lamp: Lit orange Temp: Off	Lamp has a problem. <ul style="list-style-type: none"> • Check to see if the lamp is burned out, broken, or installed incorrectly. Reseat or replace the lamp as necessary. • Clean the air filter. • If operating the projector at high altitude, set the High Altitude Mode setting to On in the projector's Extended menu.  Extended > Operation > High Altitude Mode • If the problem persists, unplug the projector and contact Epson for help. Lamp cover has a problem. <ul style="list-style-type: none"> • Check that the lamp and the lamp cover are securely installed. The lamp does not turn on if the lamp and the lamp cover are not installed correctly.
Power: Flashing blue Status: Indicator status varies Lamp: Flashing orange Temp: Indicator status varies	Replace the lamp soon to avoid damage. Do not continue using the projector.
Power: Off Status: Flashing blue Lamp: Off Temp: Flashing orange	A fan or sensor has a problem. Turn the projector off, unplug it, and contact Epson for help.
Power: Off Status: Flashing blue Lamp: Flashing orange Temp: Off	Internal projector error. Turn the projector off, unplug it, and contact Epson for help.
Power: Off Status: Flashing blue Lamp: Flashing orange Temp: Flashing orange	Auto iris error. Turn the projector off, unplug it, and contact Epson for help.

Indicator and status	Problem and solutions
Power: Off Status: Flashing blue Lamp: Lit orange Temp: Lit orange	Power error (Ballast). Turn the projector off, unplug it, and contact Epson for help.

Wireless LAN indicator and status	Problem and solutions
Lit blue	Wireless LAN is available.
Flashing blue (quickly)	Connecting to a device.
Flashing blue (slowly)	An error has occurred. Turn off the projector and restart it. If this does not solve the problem, contact Epson for help.
Off	Wireless LAN is not available. Make sure the Wireless LAN settings are correct.

 If the indicators display a pattern not listed in the table above, turn the projector off, unplug it, and contact Epson for help.

» **Related Links**

- "Cleaning the Air Filter and Vents" [p.125](#)
- "Replacing the Air Filter" [p.125](#)
- "Replacing the Lamp" [p.127](#)

You can display information to help you solve common problems using the projector's Help system.

- 1** Turn on the projector.
- 2** Press the [Home] button on the control panel or remote control.

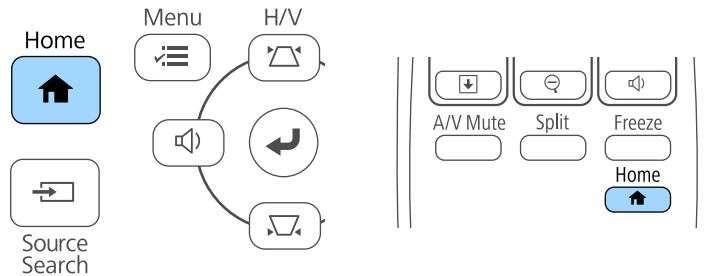

- 3** Select **Help** on the Home screen.

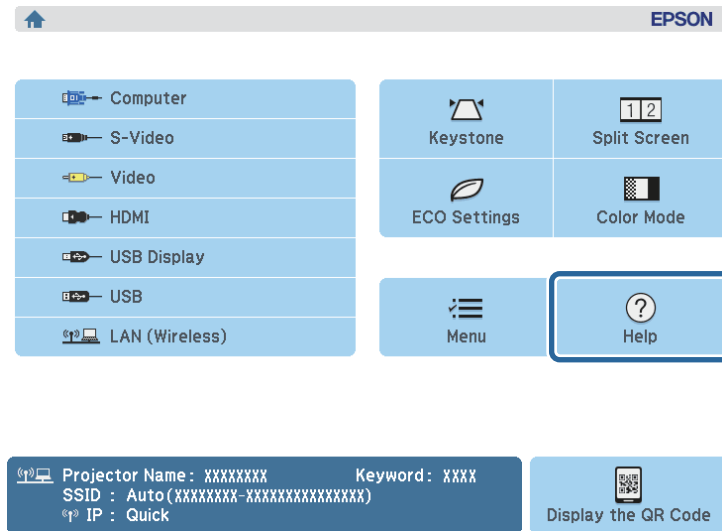

The Help menu is displayed.

- 4** Use the up and down arrow buttons to highlight the problem you want to solve.

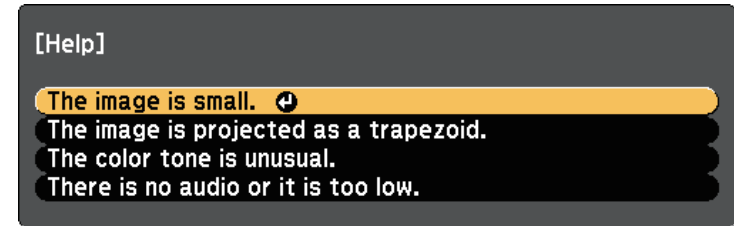

- 5** Press [Enter] to view the solutions.
- 6** Perform one of the following actions when you are finished.
 - To select another problem to solve, press [Esc].
 - To exit the help system, press [Menu].

Check the solutions in these sections if you have any problems with projected images or sound.

► Related Links

- "Solutions When No Image Appears" [p.138](#)
- "Solutions When Image is Incorrect Using the USB Display Function" [p.138](#)
- "Solutions When "No Signal" Message Appears" [p.139](#)
- "Solutions When "Not Supported" Message Appears" [p.140](#)
- "Solutions When Only a Partial Image Appears" [p.140](#)
- "Solutions When the Image is not Rectangular" [p.140](#)
- "Solutions When the Image Contains Noise or Static" [p.141](#)
- "Solutions When the Image is Fuzzy or Blurry" [p.141](#)
- "Solutions When the Image Brightness or Colors are Incorrect" [p.142](#)
- "Solutions to Sound Problems" [p.142](#)
- "Solutions When Image File Names are not Displayed Correctly in PC Free" [p.143](#)

Solutions When No Image Appears

If no image appears, try the following solutions:

- Press the power button to turn the power on.
- Make sure the lens cover is open all the way.
- Press the [A/V Mute] button on the remote control to see if the image was temporarily turned off.
- If the projector does not respond when you press the [A/V Mute] button, an internal error may have occurred in the projector. Contact Epson for help.
- Make sure all necessary cables are securely connected and the power is on for the projector and connected video sources.
- Make sure the image being projected is not completely black (only when projecting computer images).
- Make sure the projector's menu settings are correct.
- Press the projector's power button to wake it from standby or sleep mode. Also, check if the connected computer is in sleep mode or displaying a blank screen saver.

- Check the settings on the projector's **Signal** menu to make sure they are correct for the current video source.
- Adjust the **Brightness** setting in the projector's **Image** menu or select the **Normal** as the **Power Consumption** setting in the projector's **ECO** menu.
- Check the **Display** setting in the projector's **Extended** menu to make sure **Messages** is set to **On**.
- If the projector does not respond when you press the control panel buttons, the buttons may be locked. Unlock the buttons.
- If the projector does not respond when you press buttons on the remote control, make sure the remote receivers are turned on.
- For images projected with Windows Media Center, reduce the screen size from full screen mode.
- For images projected from applications using Windows DirectX, turn off DirectX functions.
- The projector may not be able to project copyrighted videos that you play back on a computer. For more details, see the manual supplied with the computer.

► Related Links

- "Input Signal Settings - Signal Menu" [p.103](#)
- "Image Quality Settings - Image Menu" [p.101](#)
- "Projector Setup Settings - ECO Menu" [p.115](#)
- "Projector Setup Settings - Extended Menu" [p.107](#)
- "Unlocking the Projector's Buttons" [p.79](#)

Solutions When Image is Incorrect Using the USB Display Function

If no image appears or if the image appears incorrectly using the USB Display function, try the following solutions:

- Press the [USB] button on the remote control.
- Make sure the Epson USB Display software has been installed correctly. Install it manually if necessary.

- For OS X, select the **USB Display** icon in the **Dock** folder. If the icon does not appear on the **Dock**, double-click **USB Display** in the **Applications** folder.
If you select **Exit** from the **USB Display** icon menu on the **Dock**, **USB Display** does not start automatically when you connect the USB cable.
 - When using a computer running Windows 2000 under user authority, a Windows error message is displayed and you may not be able to use the software. If this occurs, try updating Windows to the latest version, restart your computer, and try to connect again. Contact Epson for more details.
 - For images projected with Windows Media Center, reduce the screen size from full screen mode.
 - For images projected from applications using Windows DirectX, turn off DirectX functions.
 - If the mouse cursor flickers, select **Make the movement of the mouse pointer smooth** in the **Epson USB Display Settings** program on your computer (this feature is not available for Windows 2000).
 - Turn off the **Transfer layered window** setting in the **Epson USB Display Settings** program on your computer.
 - For projectors with a resolution of WUXGA (1920 × 1200), if you change the computer resolution during projection, the performance and quality of the video may decline.
- » **Related Links**
- "Connecting to a Computer for USB Video and Audio" [p.22](#)

Solutions When "No Signal" Message Appears

If the "No Signal" message appears, try the following solutions:

- Press the [Source Search] button and wait a few seconds for an image to appear.
- Turn on the connected computer or video source, and press play to begin your presentation, if necessary.
- Check that all cables required for projection are securely connected.
- Connect the video source directly to the projector.

- If you are projecting from a laptop computer, make sure it is set up to display on an external monitor.
- If necessary, turn off the projector and the connected computer or video source, and then turn them back on.
- If you are projecting from an HDMI source, replace the HDMI cable with the shorter one.

» Related Links

- "Displaying From a Laptop" [p.139](#)
- "Displaying From a Mac Laptop" [p.139](#)

Displaying From a Laptop

If the message "No Signal" is displayed when projecting from a laptop, you need to set up the laptop to display on an external monitor.

- 1** Hold down the laptop's **Fn** key and press the key labeled with a monitor icon or **CRT/LCD**. (See your laptop manual for details.) Wait a few seconds for an image to appear.
- 2** To display on the laptop's monitor and the projector, try pressing the same keys again.
- 3** If the same image is not displayed by the laptop and projector, check the Windows **Display** utility to make sure the external monitor port is enabled and extended desktop mode is disabled. (See your computer or Windows manual for instructions.)
- 4** If necessary, check your video card settings and set the multiple display option to **Clone** or **Mirror**.

Displaying From a Mac Laptop

If the message "No Signal" is displayed when projecting from a Mac laptop, you need to set up the laptop for mirrored display. (See your laptop manual for details.)

- 1 Open the **System Preferences** utility and select **Displays**.
- 2 Select the **Display** or **Color LCD** option, if necessary.
- 3 Click the **Arrange** or **Arrangement** tab.
- 4 Select **Mirror Displays**.

Solutions When "Not Supported" Message Appears

If the message "Not supported" is displayed, try the following solutions:

- Make sure the correct input signal is selected on the projector's **Signal** menu.
- Make sure the computer's display resolution does not exceed the projector's resolution and frequency limits. If necessary, select a different display resolution for your computer. (See your computer manual for details.)

» Related Links

- "Input Signal Settings - Signal Menu" [p.103](#)

Solutions When Only a Partial Image Appears

If only a partial computer image appears, try the following solutions:

- Press the [Auto] button on the remote control to optimize the image signal.
- Try adjusting the image position using the **Position** setting in the projector's **Signal** menu.
- Press the [Aspect] button on the remote control to select a different image aspect ratio.
- Change the **Resolution** setting in the projector's **Signal** menu according to the signal for the connected equipment.
- If you zoomed into or out of the image using the [E-Zoom] buttons, press the [Esc] button until the projector returns to a full display.

- Check your computer display settings to disable dual display and set the resolution within the projector's limits. (See your computer manual for details.)
- Check the resolution assigned to your presentation files to see if they are created for a different resolution. (See your software help for details.)
- Make sure you selected the correct projection mode. You can select **Front**, **Front/Ceiling**, **Rear**, or **Rear/Ceiling** as the **Projection** setting in the projector's **Extended** menu.

» Related Links

- "Input Signal Settings - Signal Menu" [p.103](#)
- "Projector Setup Settings - Extended Menu" [p.107](#)
- "Supported Monitor Display Resolutions" [p.153](#)

Solutions When the Image is not Rectangular

If the projected image is not evenly rectangular, try the following solutions:

- Place the projector directly in front of the center of the screen, facing it squarely, if possible.
- If you adjusted the projector height using the projector feet, press the keystone buttons on the projector to adjust the image shape.
- Turn on horizontal keystone slider in the projector's **Settings** menu. Then, adjust the slider until the image is evenly rectangular.
 - ☛ **Settings > Keystone > H/V-Keystone > H-Keystone Adjuster**
- Turn on automatic adjustment in the projector's **Settings** menu. The projector automatically corrects the image every time you move the projector.
 - ☛ **Settings > Keystone > H/V-Keystone > Auto V-Keystone**
- Adjust the Quick Corner setting to correct the image shape.
 - ☛ **Settings > Keystone > Quick Corner**

» Related Links

- "Auto V-Keystone" [p.41](#)
- "Correcting the Image Shape with the Keystone Buttons" [p.42](#)
- "Correcting the Image Shape with Quick Corner" [p.43](#)

Solutions When the Image Contains Noise or Static

If the projected image contains electronic interference (noise) or static, try the following solutions:

- Check the cables connecting your computer or video source to the projector. They should be:
 - Separated from the power cord to prevent interference
 - Securely connected at both ends
 - Not connected to an extension cable
 - No longer than 3 meters
- Check the settings on the projector's **Signal** menu to make sure they match the video source.
- If available for your video source, adjust the **Deinterlacing** and **Noise Reduction** settings in the **Image** menu.
- Select a computer video resolution and refresh rate that are compatible with the projector.
- If you are projecting from a computer, press the [Auto] button on the remote control to automatically adjust the **Tracking** and **Sync.** settings. If the images are not adjusted correctly, manually adjust the **Tracking** and **Sync.** settings in the projector's **Signal** menu.
- Select **Auto** as the **Resolution** setting in the projector's **Signal** menu.
- If you adjusted the image shape using the projector controls, try decreasing the **Sharpness** setting in the projector's **Image** menu to improve image quality.
- If you connected an extension power cable, try projecting without it to see if it caused interference in the signal.
- If you are using the USB Display function, turn off the **Transfer layered window** setting in the **Epson USB Display Settings** program on your computer.

» Related Links

- "Input Signal Settings - Signal Menu" [p.103](#)
- "Image Quality Settings - Image Menu" [p.101](#)
- "Supported Monitor Display Resolutions" [p.153](#)

Solutions When the Image is Fuzzy or Blurry

If the projected image is fuzzy or blurry, try the following solutions:

- Adjust the image focus.
- Clean the projector lens.



To avoid condensation on the lens after bringing the projector in from a cold environment, let the projector warm up to room temperature before using it.

- Position the projector close enough to the screen.
- Position the projector so the keystone adjustment angle is not so wide that it distorts the image.
- Turn on automatic adjustment in the projector's **Settings** menu.
 - ☛ **Settings > Keystone > H/V-Keystone > Auto V-Keystone**
- Adjust the **Sharpness** setting in the projector's **Image** menu to improve image quality.
- If you are projecting from a computer, press the [Auto] button on the remote control to automatically adjust the tracking and sync. If any bands or overall blurriness remain, display a uniformly patterned image on the screen and manually adjust the **Tracking** and **Sync.** settings in the projector's **Signal** menu.
- If you are projecting from a computer, use a lower resolution or select a resolution that matches the projector's native resolution.

» Related Links

- "Input Signal Settings - Signal Menu" [p.103](#)
- "Image Quality Settings - Image Menu" [p.101](#)
- "Supported Monitor Display Resolutions" [p.153](#)
- "Focusing the Image Using the Focus Ring" [p.48](#)
- "Cleaning the Lens" [p.123](#)

Solutions When the Image Brightness or Colors are Incorrect

If the projected image is too dark or light, or the colors are incorrect, try the following solutions:

- Press the [Color Mode] button on the remote control to try different color modes for the image and environment.
- Check your video source settings.
- Adjust the available settings on the projector's **Image** menu for the current input source, such as **Brightness**, **Contrast**, **Tint**, **Color Temp.**, and/or **Color Saturation**.
- Make sure you selected the correct **Input Signal** or **Video Signal** setting in the projector's **Signal** menu, if available for your image source.
 - ☛ **Signal > Advanced > Input Signal**
 - ☛ **Signal > Advanced > Video Signal**
- Make sure all the cables are securely connected to the projector and your video device. If you connected long cables, try connecting shorter cables.
- If you are using the **ECO** as the **Power Consumption** setting, try selecting **Normal** in the projector's **ECO** menu.



At high altitudes or locations subject to high temperatures, the image may become darker and you may not be able to adjust the **Power Consumption** setting.

- Position the projector close enough to the screen.
- If the image has been progressively darkening, you may need to replace the projector lamp soon.

» Related Links

- "Color Mode" [p.53](#)
- "Input Signal Settings - Signal Menu" [p.103](#)
- "Image Quality Settings - Image Menu" [p.101](#)
- "Projector Setup Settings - ECO Menu" [p.115](#)

Solutions to Sound Problems

If there is no sound or the volume is too low or high, try the following solutions:

- Adjust the projector's volume settings.
- Press the [A/V Mute] button on the remote control to resume video and audio if they were temporarily stopped.
- Check your computer or video source to make sure the volume is turned up and the audio output is set for the correct source.
- Disconnect the audio cable, and then reconnect it.
- Check the audio cable connections between the projector and your video source.
- If you do not hear sound from an HDMI source, set the connected device to PCM output.
- Make sure any connected audio cables are labeled "No Resistance".
- If you are using the USB Display function, turn on the **Output audio from the projector** setting in the **Epson USB Display Settings** program on your computer.
- When you are connecting the projector to a Mac using an HDMI cable, make sure your Mac supports audio through the HDMI port.
- If the volume for the computer is set to the minimum while the projector is set to the maximum, the noise may be mixed. Turn up the computer's volume and turn down the projector's volume. (When you use EasyMP Network Projection, EasyMP Multi PC Projection, USB Display or Quick Wireless Connection.)

» Related Links

- "Projector Connections" [p.21](#)
- "Projector Setup Settings - Extended Menu" [p.107](#)
- "Projector Setup Settings - ECO Menu" [p.115](#)
- "Controlling the Volume with the Volume Buttons" [p.55](#)

Solutions When Image File Names are not Displayed Correctly in PC Free

If any file names are longer than the display area or include unsupported symbols, the file names are shortened or changed in PC Free. Shorten or change the file name.

Check the solutions in these sections if you have problems operating the projector or remote control.

» Related Links

- "Solutions to Projector Power or Shut-Off Problems" [p.144](#)
- "Solutions to Problems with the Remote Control" [p.144](#)
- "Solutions to Password Problems" [p.145](#)

Solutions to Projector Power or Shut-Off Problems

If the projector does not turn on when you press the power button or it turns off unexpectedly, try the following solutions:

- Make sure the power cord is securely connected to the projector and to a working electrical outlet.
- The projector's buttons may be locked for security. Unlock the buttons in the **Control Panel Lock** setting in the projector's **Settings** menu or use the remote control to turn on the projector.
☛ **Settings > Lock Setting > Control Panel Lock**
- The power cord may be defective. Disconnect the cord and contact Epson for help.
- If the projector's lamp turns off unexpectedly, it may have entered sleep mode after a period of inactivity. Perform any operation to wake the projector. To turn off sleep mode, select **Off** as the **Sleep Mode** setting in the projector's **ECO** menu.
- If the projector's lamp turns off unexpectedly, the A/V mute timer may be enabled. To turn off the A/V mute timer, select **Off** as the **A/V Mute Timer** setting in the projector's **ECO** menu.
- If the projector's lamp turns off unexpectedly, the lens cover timer may be enabled. To turn off the lens cover timer, select **Off** as the **Lens Cover Timer** setting in the projector's **ECO** menu.
- If the projector's lamp turns off, the Status indicator is flashing, and the Temp indicator is lit, the projector has overheated and turned off.
- If the power button on the remote control does not turn on the projector, check its batteries and make sure the **Remote Receiver** setting in the projector's **Settings** menu is turned on if available.

» Related Links

- "Projector Setup Settings - ECO Menu" [p.115](#)
- "Projector Indicators Status" [p.135](#)
- "Projector Feature Settings - Settings Menu" [p.105](#)
- "Unlocking the Projector's Buttons" [p.79](#)

Solutions to Problems with the Remote Control

If the projector does not respond to remote control commands, try the following solutions:

- Check that the remote control batteries are installed correctly and have power. If necessary, replace the batteries.
- Make sure you are operating the remote control within the reception angle and range of the projector.
- Make sure the projector is not warming up or shutting down.
- Check to see if a button on the remote control is stuck down, causing it to enter sleep mode. Release the button to wake the remote control up.
- Strong fluorescent lighting, direct sunlight, or infrared device signals may be interfering with the projector's remote receivers. Dim the lights or move the projector away from the sun or interfering equipment.
- Make sure at least one of the remote receivers are available in the **Remote Receiver** setting in the projector's **Settings** menu.
- If the **Remote Receiver** setting is disabled, hold down the [Menu] button on the remote control for at least 15 seconds to reset the setting to its default.
- If you assigned an ID number to the projector to operate multiple projectors from the remote control, you may need to check or change the ID setting.
- If you lose the remote control, you can order another one from Epson.

» Related Links

- "Remote Control Operation" [p.30](#)
- "Projector Feature Settings - Settings Menu" [p.105](#)
- "Selecting the Projector You want to Operate" [p.73](#)
- "Replacing the Remote Control Batteries" [p.132](#)

Solutions to Password Problems

If you cannot enter or remember a password, try the following solutions:

- You may have turned on password protection without first setting a password. Try entering **0000** using the remote control.
- If you have entered an incorrect password too many times and see a message displaying a request code, write down the code and contact Epson for help. Provide the request code and proof of ownership for assistance in unlocking the projector.
- If you lose the remote control you cannot enter a password. Order a new one from Epson.

Check the solutions in these sections if you have problems using the projector on a network.

► Related Links

- "Solutions When You Cannot Access the Projector Through the Web" [p.146](#)
- "Solutions When Network Alert E-Mails are not Received" [p.146](#)
- "Solutions When the Image Contains Static During Network Projection" [p.146](#)

Solutions When You Cannot Access the Projector Through the Web

If you are unable to access the projector through a Web browser, make sure you are using the correct ID and password.

- For the user ID, enter **EPSONWEB**. (You cannot change the user ID.)
- For the password, enter the password set in the projector's network **Basic** menu. The default password is **admin**.
- Make sure you have access to the network the projector is on.



The user ID and password are case sensitive.

► Related Links

- "Network Menu - Basic Menu" [p.109](#)

Solutions When Network Alert E-Mails are not Received

If you do not receive an e-mail alerting you to problems with a projector over the network, try the following solutions:

- Make sure the projector is turned on and connected to the network correctly. (If an error shut down the projector, it cannot send an e-mail.)
- Make sure you set up the projector e-mail alert settings correctly on the projector's network **Mail** menu or in the network software.

- Set the **Standby Mode** setting to **Communication On** in the projector's **ECO** menu so the network software can monitor the projector in standby mode.
- Make sure your electrical outlet or power source is functioning correctly.

► Related Links

- "Network Menu - Mail Menu" [p.112](#)

Solutions When the Image Contains Static During Network Projection

If the projected image contains static during network projection, try the following solutions:

- Check for any obstacles between the access point, the computer, the mobile device, and the projector, and change their positions to improve communication.
- Make sure that the access point, the computer, the mobile device and the projector are not too far apart. Move them closer together and try to connect again.
- If the wireless connection is slow or your projected image contains noise, check for interference from other equipment, such as a Bluetooth device or microwave. Move the interfering device farther away or expand your wireless bandwidth.
- Reduce the number of connected devices if the connection speed declines.

Appendix

Check these sections for the technical specifications and important notices about your projector.

► **Related Links**

- "Optional Accessories and Replacement Parts" [p.148](#)
- "Screen Size and Projection Distance" [p.149](#)
- "Supported Monitor Display Resolutions" [p.153](#)
- "Projector Specifications" [p.155](#)
- "External Dimensions" [p.157](#)
- "USB Display System Requirements" [p.159](#)
- "List of Safety Symbols (corresponding to IEC60950-1 A2)" [p.160](#)
- "Glossary" [p.162](#)
- "Notices" [p.164](#)

The following optional accessories and replacement parts are available. Please purchase these products as and when needed. The following list of optional accessories and replacement parts is current as of: March 2015. Details of accessories are subject to change without notice and availability may vary depending on the country of purchase.

► Related Links

- "Optional Accessories" p.148
- "Replacement Parts" p.148

Optional Accessories

Interactive Unit ELPIU01

Use when operating the computer screen on the projection surface.

Document Camera ELPDC06/ELPDC11/ELPDC12/ELPDC20

Use when projecting image such as books, OHP documents, or slides.

Soft carrying case ELPKS63 (EB-W32/EB-W31/EB-X36/EB-X31/EB-S31/EB-W04/EB-X04/EB-S04/EB-W130/EB-X130/EB-S130/EB-X350/EB-X300/EB-S300)

Soft carrying case ELPKS67 (EB-U32/EB-U04/EB-U130)

Use this to carry the projector by hand.

60" portable screen ELPSC27

80" portable screen ELPSC28

100" portable screen ELPSC29

Portable roll-type screens. (aspect ratio 4:3)

70" portable screen ELPSC23

80" portable screen ELPSC24

90" portable screen ELPSC25

Portable roll-type screens. (aspect ratio 16:10)

64" portable screen ELPSC31

Portable magnetic screens. (aspect ratio 4:3)

50" portable screen ELPSC32

A compact screen that can be carried easily. (aspect ratio 4:3)

Multi Aspect Screen ELPSC26

Portable multi-aspect screen.

Computer cable ELPKC02 (1.8 m - for mini D-sub 15-pin/mini D-Sub 15pin)

Computer cable ELPKC09 (3 m - for mini D-sub 15-pin/mini D-Sub 15pin)

Computer cable ELPKC10 (20 m - for mini D-sub 15-pin/mini D-Sub 15pin)

Use when connecting to the computer port.

Component video cable ELPKC19 (3 m - for mini D-Sub 15-pin/RCA male x 3)

Use this to connect a component video source.

Wireless LAN module ELPAP10

Use this to project images from a computer via a wireless communication.

Quick Wireless Connection USB Key ELPAP09

Use when you want to quickly establish one-to-one connection between the projector and a component with Windows installed.

Ceiling pipe (450 mm) ELPFP13

Ceiling pipe (700 mm) ELPFP14

Use when installing the projector on a high ceiling.

Ceiling mount ELPMB23

Use when installing the projector on a ceiling.



Special expertise is required to suspend the projector from a ceiling. Contact Epson for help.

Replacement Parts

Lamp unit ELPLP88

Use as a replacement for used lamps.

Air filter ELPAF32

Use as a replacement for used air filters.

Check the table here to determine how far to place the projector from the screen based on the size of the projected image.

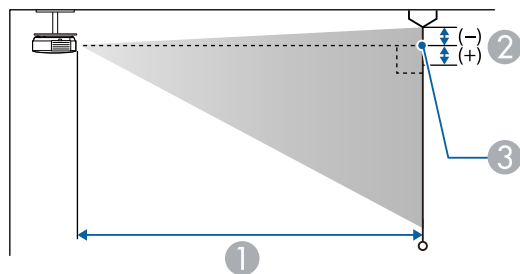
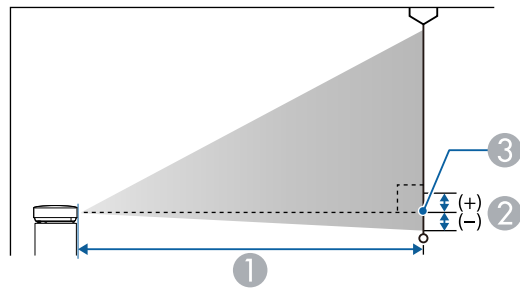

- ① Projection distance (cm)
- ② Distance from the center of the lens to the base of the screen (or to the top of the screen, if suspended from a ceiling) (cm)
- ③ Center of lens

SVGA (EB-S31/EB-S04/EB-S130/EB-S300)

4:3 screen size		①	②
		Minimum (Wide) to Maximum (Tele)	Minimum (Wide)
30"	61 × 46	88 - 119	-5
50"	102 × 76	147 - 200	-8

4:3 screen size		①	②
		Minimum (Wide) to Maximum (Tele)	Minimum (Wide)
60"	122 × 91	177 - 240	-10
70"	142 × 107	207 - 280	-12
80"	163 × 122	237 - 321	-13
100"	203 × 152	297 - 401	-17
150"	305 × 229	446 - 603	-25
200"	406 × 305	595 - 805	-33

16:9 screen size		①	②
		Minimum (Wide) to Maximum (Tele)	Minimum (Wide)
28"	62 × 35	89 - 121	1
30"	66 × 37	96 - 130	1
50"	111 × 62	161 - 218	1
60"	133 × 75	193 - 262	2
70"	155 × 87	226 - 306	2
80"	177 × 100	258 - 349	2
100"	221 × 125	323 - 437	3
150"	332 × 187	486 - 657	4
200"	443 × 249	649 - 877	5

XGA (EB-X31/EB-X04/EB-X130/EB-X350/EB-X300)

4:3 screen size		①	②
		Minimum (Wide) to Maximum (Tele)	
30"	61 × 46	89 - 107	-5
40"	81 × 61	119 - 143	-7

4:3 screen size		①	②
		Minimum (Wide) to Maximum (Tele)	
50"	102 × 76	150 - 180	-8
60"	122 × 91	180 - 217	-10
80"	163 × 122	241 - 290	-14
100"	203 × 152	302 - 363	-17
150"	305 × 229	454 - 546	-25
200"	406 × 305	607 - 729	-34
250"	508 × 381	759 - 912	-42
300"	610 × 457	912 - 1095	-51

16:9 screen size		①	②
		Minimum (Wide) to Maximum (Tele)	
28"	62 × 35	90 - 109	1
30"	66 × 37	97 - 117	1
40"	89 × 50	130 - 156	1
50"	111 × 62	163 - 196	1
60"	133 × 75	196 - 236	1
80"	177 × 100	263 - 316	2
100"	221 × 125	329 - 396	2
150"	332 × 187	495 - 595	3
200"	443 × 249	661 - 794	5
250"	553 × 311	827 - 994	6
275"	609 × 342	910 - 1093	6

XGA (EB-X36)

4:3 screen size		①	②
		Minimum (Wide) to Maximum (Tele)	
30"	61 × 46	84 - 101	-5
40"	81 × 61	113 - 136	-6
50"	102 × 76	142 - 171	-8
60"	122 × 91	171 - 206	-10
80"	163 × 122	229 - 275	-13
100"	203 × 152	287 - 345	-16
150"	305 × 229	432 - 519	-24
200"	406 × 305	577 - 693	-32
250"	508 × 381	722 - 867	-40
300"	610 × 457	867 - 1041	-48

16:9 screen size		①	②
		Minimum (Wide) to Maximum (Tele)	
28"	62 × 35	85 - 103	1
30"	66 × 37	91 - 110	1
40"	89 × 50	123 - 148	1
50"	111 × 62	155 - 186	2
60"	133 × 75	186 - 224	2
80"	177 × 100	249 - 300	3
100"	221 × 125	313 - 376	3
150"	332 × 187	471 - 566	5
200"	443 × 249	629 - 755	7
250"	553 × 311	787 - 945	9
275"	609 × 342	866 - 1040	10

WXGA (EB-W32/EB-W31/EB-W04/EB-W130)

4:3 screen size		①	②
		Minimum (Wide) to Maximum (Tele)	
29"	59 × 44	90 - 109	-4
30"	61 × 46	94 - 113	-4
40"	81 × 61	126 - 152	-5
50"	102 × 76	158 - 190	-7
60"	122 × 91	190 - 229	-8
70"	142 × 107	222 - 267	-10
80"	163 × 122	255 - 306	-11
100"	203 × 152	319 - 383	-14
150"	305 × 229	480 - 577	-20
200"	406 × 305	641 - 770	-27
280"	569 × 427	898 - 1079	-38

16:9 screen size		①	②
		Minimum (Wide) to Maximum (Tele)	
32"	71 × 40	91 - 109	-2
35"	77 × 44	99 - 120	-2
40"	89 × 50	114 - 137	-2
50"	111 × 62	143 - 172	-3
60"	133 × 75	172 - 208	-3
70"	155 × 87	202 - 243	-4
80"	177 × 100	231 - 278	-4
100"	221 × 125	289 - 348	-5
150"	332 × 187	435 - 523	-8
200"	443 × 249	582 - 699	-11

16:9 screen size		①	②
		Minimum (Wide) to Maximum (Tele)	
310"	686 × 386	903 - 1084	-17

16:10 screen size		①	②
		Minimum (Wide) to Maximum (Tele)	
33"	71 × 44	91 - 110	-4
35"	75 × 47	97 - 117	-4
40"	86 × 54	111 - 134	-5
50"	108 × 67	139 - 168	-6
60"	129 × 81	168 - 202	-7
80"	172 × 108	225 - 270	-10
100"	215 × 135	281 - 338	-12
150"	323 × 202	424 - 509	-18
200"	431 × 269	566 - 680	-24
320"	689 × 431	907 - 1089	-39

WUXGA (EB-U32/EB-U04/EB-U130)

4:3 screen size		①	②
		Minimum (Wide) to Maximum (Tele)	
27"	55 × 41	89 - 109	-4
30"	61 × 46	99 - 121	-4
40"	81 × 61	133 - 163	-6
50"	102 × 76	168 - 205	-7
60"	122 × 91	202 - 246	-8
70"	142 × 107	236 - 288	-10

4:3 screen size		①	②
		Minimum (Wide) to Maximum (Tele)	
80"	163 × 122	270 - 329	-11
100"	203 × 152	339 - 412	-14
150"	305 × 229	509 - 620	-21
200"	406 × 305	680 - 828	-28
260"	528 × 396	885 - 1078	-36

16:9 screen size		①	②
		Minimum (Wide) to Maximum (Tele)	
30"	66 × 37	90 - 110	-2
35"	77 × 44	105 - 129	-2
40"	89 × 50	121 - 148	-2
50"	111 × 62	152 - 185	-3
60"	133 × 75	183 - 223	-3
70"	155 × 87	214 - 261	-4
80"	177 × 100	245 - 299	-5
100"	221 × 125	307 - 374	-6
150"	332 × 187	462 - 563	-8
200"	443 × 249	617 - 752	-11
290"	642 × 361	897 - 1091	-16

16:10 screen size		①	②
		Minimum (Wide) to Maximum (Tele)	
30"	65 × 40	87 - 107	-4
35"	75 × 47	102 - 125	-4

16:10 screen size		①	②
		Minimum (Wide) to Maximum (Tele)	
40"	86 × 54	118 - 144	-5
50"	108 × 67	148 - 180	-6
60"	129 × 81	178 - 217	-7
80"	172 × 108	238 - 291	-10
100"	215 × 135	299 - 364	-12
150"	323 × 202	450 - 548	-18
200"	431 × 269	601 - 731	-24
300"	646 × 404	902 - 1098	-37

The table here lists the compatible refresh rate and resolution for each compatible video display format.

Component Signals (Analog RGB)

For EB-U32/EB-W32/EB-W31/EB-X36/EB-X31/EB-U04/EB-W04/EB-X04/EB-U130/EB-W130/EB-X130/EB-X350/EB-X300

Signal	Refresh rate (Hz)	Resolution (dots)
VGA	60/72/75/85	640 × 480
SVGA	60/72/75/85	800 × 600
XGA	60/70/75/85	1024 × 768
WXGA	60	1280 × 768
	60	1366 × 768
	60/75/85	1280 × 800
WXGA+	60/75/85	1440 × 900
WXGA++	60	1600 × 900
SXGA	70/75/85	1152 × 864
	60/75/85	1280 × 960
	60/75/85	1280 × 1024
SXGA+	60/75	1400 × 1050
WSXGA+ *	60	1680 × 1050
UXGA	60	1600 × 1200
WUXGA **	60	1920 × 1200

* WSXGA+ is available only for EB-U32/EB-W32/EB-W31/EB-U04/EB-W04/EB-U130/EB-W130 and compatible only when **Wide** is selected as the **Resolution** setting in the projector's **Signal** menu.

** WUXGA is available only for EB-U32/EB-U04/EB-U130.

For EB-S31/EB-S04/EB-S130/EB-S300

Signal	Refresh rate (Hz)	Resolution (dots)
VGA	60/72/75/85	640 × 480
SVGA	60/72/75/85	800 × 600
XGA	60/70/75/85	1024 × 768
WXGA	60	1280 × 768
	60	1366 × 768
	60/75	1280 × 800
WXGA+	60	1440 × 900
SXGA	70/75	1152 × 864
	60	1280 × 960
	60	1280 × 1024
SXGA+	60	1400 × 1050

Even when signals other than those mentioned above are input, it is likely that the image can be projected. However, not all functions may be supported.

Component Video

Signal	Refresh rate (Hz)	Resolution (dots)
SDTV (480i/480p)	60	720 × 480
SDTV (576i/576p)	50	720 × 576
HDTV (720p)	50/60	1280 × 720
HDTV (1080i)	50/60	1920 × 1080

Composite Video

Signal	Refresh rate (Hz)	Resolution (dots)
TV (NTSC)	60	720 × 480
TV (SECAM)	50	720 × 576
TV (PAL)	50/60	720 × 576

HDMI Input Signal

Signal	Refresh rate (Hz)	Resolution (dots)
VGA	60	640 × 480
SVGA	60	800 × 600
XGA	60	1024 × 768
WXGA	60	1280 × 800
	60	1366 × 768
WXGA+	60	1440 × 900
WXGA++ *	60	1600 × 900
UXGA *	60	1600 × 1200
WSXGA+ **	60	1680 × 1050
WUXGA ***	60	1920 × 1200
SXGA	60	1280 × 960
	60	1280 × 1024
SXGA+	60	1400 × 1050
SDTV (480i/480p)	60	720 × 480
SDTV (576i/576p)	50	720 × 576
HDTV (720p)	50/60	1280 × 720
HDTV (1080i)	50/60	1920 × 1080
HDTV (1080p)	24/30/50/60	1920 × 1080

* Available only for EB-U32/EB-W32/EB-W31/EB-X36/EB-X31/EB-U04/EB-W04/EB-X04/EB-U130/EB-W130/EB-X130/EB-X350/EB-X300.

** Available only for EB-U32/EB-W32/EB-W31/EB-U04/EB-W04/EB-U130/EB-W130.

*** Available only for EB-U32/EB-U04/EB-U130.

MHL Input Signal (EB-U32/EB-W32/EB-W31/EB-U04/EB-U130)

Signal	Refresh rate (Hz)	Resolution (dots)
VGA	60	640 × 480
SDTV (480i/480p)	60	720 × 480
SDTV (576i/576p)	50	720 × 576
HDTV (720p)	50/60	1280 × 720
HDTV (1080i)	50/60	1920 × 1080
HDTV (1080p)	24/30	1920 × 1080

Product name	EB-U32/EB-W32/EB-W31/EB-X36/EB-X31/EB-S31/EB-U04/EB-W04/EB-X04/EB-S04/EB-U130/EB-W130/EB-X130/EB-S130/EB-X350/EB-X300/EB-S300
Dimensions	EB-W32/EB-W31/EB-X36/EB-X31/EB-S31/EB-W04/EB-X04/EB-S04/EB-W130/EB-X130/EB-S130/EB-X350/EB-X300/EB-S300: 297 (W) × 77 (H) × 234 (D) mm (not including raised section) EB-U32/EB-U04/EB-U130: 297 (W) × 77 (H) × 244 (D) mm (not including raised section)
LCD panel size	EB-X31/EB-S31/EB-X04/EB-S04/EB-X130/EB-S130/EB-X350/EB-X300/EB-S300: 0.55" EB-X36: 0.63" EB-W32/EB-W31/EB-W04/EB-W130: 0.59" EB-U32/EB-U04/EB-U130: 0.67"
Display method	Poly-silicon TFT active matrix
Resolution	EB-S31/EB-S04/EB-S130/EB-S300: 480,000 pixels SVGA (800 (W) × 600 (H) dots) × 3 EB-X36/EB-X31/EB-X04/EB-X130/EB-X350/EB-X300: 786,432 pixels XGA (1024 (W) × 768 (H) dots) × 3 EB-W32/EB-W31/EB-W04/EB-W130: 1024,000 pixels WXGA (1280 (W) × 800 (H) dots) × 3 EB-U32/EB-U04/EB-U130: 2,304,000 pixels WUXGA (1920 (W) × 1200 (H) dots) × 3
Focus adjustment	Manual

Zoom adjustment	EB-S31/EB-S04/EB-S130/EB-S300: 1.0 - 1.35 (Digital Zoom) EB-U32/EB-W32/EB-W31/EB-X36/EB-X31/EB-U04/EB-W04/EB-X04/EB-U130/EB-W130/EB-X130/EB-X350/EB-X300: 1 - 1.2	
Lamp	UHE lamp, 200 W Model No.: ELPLP88	
Lamp life	<ul style="list-style-type: none"> • Normal Power Consumption mode: Up to 5000 hours • ECO Power Consumption mode: Up to 10000 hours 	
Max. audio output	EB-W04/EB-X04/EB-S04/EB-W130/EB-X130/EB-S130/EB-X300/EB-S300: 1W EB-U32/EB-W32/EB-W31/EB-X36/EB-X31/EB-S31/EB-U04/EB-U130/EB-X350: 2W	
Speaker	1	
Power supply	100-240V AC±10% 50/60Hz 2.9 - 1.3 A	
Power consumption	100 to 120 V area	Operating: 291 W Standby power consumption (Communication On): 2.3 W Standby power consumption (Communication Off): 0.2 W
	220 to 240 V area	Operating: 277 W Standby power consumption (Communication On): 2.4 W Standby power consumption (Communication Off): 0.26 W
Operating altitude	Altitude 0 to 3,000 m	
Operating temperature	+5 to +35°C (No condensation) (Altitude 0 to 2,286 m) +5 to +30°C (No condensation) (Altitude 2,287 to 3,000 m)	
Storage temperature	-10 to +60°C (No condensation)	

Mass	EB-W32/EB-W31/EB-X36/EB-X31/EB-S31/EB-W04/EB-X04/EB-S04/EB-W130/EB-X130/EB-S130/EB-X350/EB-X300/EB-S300: Approx. 2.4 kg EB-U32/EB-U04/EB-U130: Approx. 2.6 kg
------	--

This product is also designed for IT power distribution system with phase-to-phase voltage 230V.

Angle of tilt

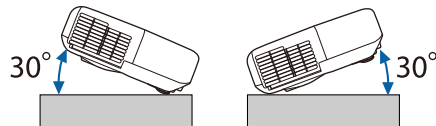

If you use the projector tilted at an angle of more than 30° it could be damaged and cause an accident.

» Related Links

- "Connector Specifications" [p.156](#)

HDMI port (EB-X36/EB-X31/EB-S31/EB-W04/EB-X04/EB-S04/EB-W130/EB-X130/EB-S130/EB-X350/EB-X300/EB-S30)	1	HDMI (Audio is only supported by PCM)
HDMI/MHL port (EB-W32/EB-W31)		
HDMI1, HDMI2/MHL port (EB-U32/EB-U04/EB-U130)		
USB-A port	1	USB connector (Type A)
USB-B port	1	USB connector (Type B)



- USB-A and USB-B port supports USB 2.0. However, USB ports are not guaranteed to operate all devices that support USB.
- USB-B port is not support USB 1.1.

Connector Specifications

Computer port	1	Mini D-Sub15-pin (female)
Video port	1	RCA pin jack
S-Video port (EB-W32/EB-W31/EB-X36/EB-X31/EB-S31/EB-W04/EB-X04/EB-S04/EB-W130/EB-X130/EB-S130/EB-X350/EB-X300/EB-S30)	1	Mini DIN 4-pin
Audio port	1	RCA pin jack x 2 (L-R)

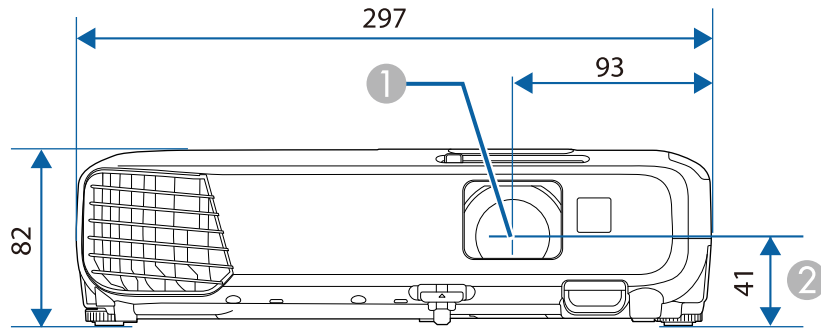

- ① Center of lens
- ② Distance from center of lens to suspension bracket fixing point

EB-U32/EB-U04/EB-U130

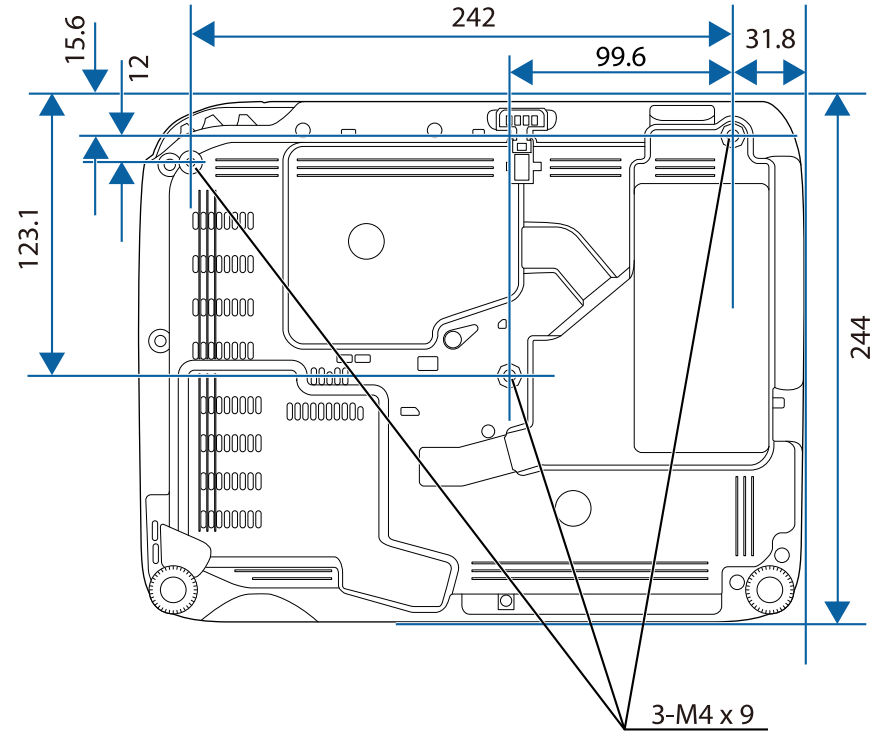

EB-W32/EB-W31/EB-X36/EB-X31/EB-S31/EB-W04/EB-X04/EB-S04/EB-W130/EB-X130/EB-S130/EB-X350/EB-X300/EB-S300

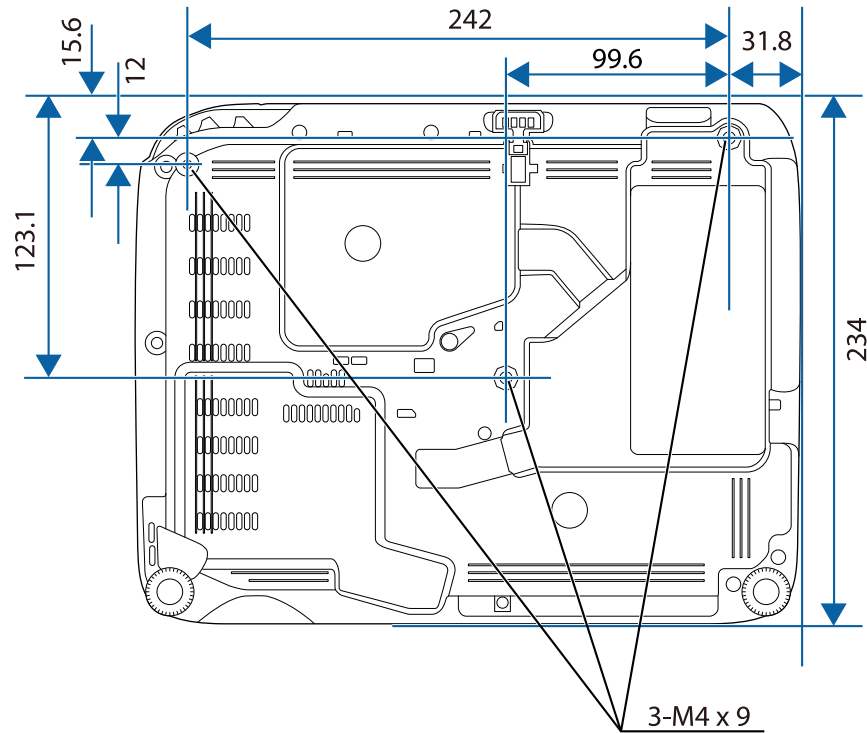









The unit in these illustrations is mm.







To use the projector's Epson USB Display software, your computer must meet the following system requirements.





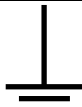

Requirement	Windows	Mac
Operating system	Windows 2000 (Service Pack 4 only)	OS X <ul style="list-style-type: none"> • Mac OS X 10.5.x (32-bit) • Mac OS X 10.6.x (32- and 64-bit) • OS X 10.7.x (32- and 64-bit) • OS X 10.8.x (64-bit) • OS X 10.9.x (64-bit) • OS X 10.10.x (64-bit)
	Windows XP <ul style="list-style-type: none"> • Professional (32-bit) • Home Edition (32-bit) • Tablet PC Edition (32-bit) 	
	Windows Vista <ul style="list-style-type: none"> • Ultimate (32-bit) • Enterprise (32-bit) • Business (32-bit) • Home Premium (32-bit) • Home Basic (32-bit) 	
	Windows 7 <ul style="list-style-type: none"> • Ultimate (32- and 64-bit) • Enterprise (32- and 64-bit) • Professional (32- and 64-bit) • Home Premium (32- and 64-bit) • Home Basic (32-bit) • Starter (32-bit) 	
	Windows 8 <ul style="list-style-type: none"> • Windows 8 (32- and 64-bit) • Windows 8 Pro (32- and 64-bit) • Windows 8 Enterprise (32- and 64-bit) 	

Requirement	Windows	Mac
	Windows 8.1 <ul style="list-style-type: none"> • Windows 8.1 (32- and 64-bit) • Windows 8.1 Pro (32- and 64-bit) • Windows 8.1 Enterprise (32- and 64-bit) 	
CPU	Mobile Pentium III 1.2 GHz or faster (Pentium M 1.6 GHz or faster recommended)	Power PC G4 1 GHz or faster (Core Duo 1.83 GHz or faster recommended)
Memory	256 MB or more (512 MB or more recommended)	512 MB or more
Hard disk space	20 MB or more	20 MB or more
Display	Resolution between 640 × 480 and 1920 × 1200 16-bit color or greater	Resolution between 640 × 480 and 1920 × 1200 16-bit color or greater

The following table lists the meaning of the safety symbols labeled on the equipment.

No.	Symbol mark	Approved standards	Description
1		IEC60417 No.5007	"ON" (power) To indicate connection to the mains.
2		IEC60417 No.5008	"OFF" (power) To indicate disconnection from the mains.
3		IEC60417 No.5009	Stand-by To identify the switch or switch position by means of which part of the equipment is switched on in order to bring it into the stand-by condition.
4		ISO7000 No.0434B, IEC3864-B3.1	Caution To identify general caution when using the product.
5		IEC60417 No.5041	Caution, hot surface To indicate that the marked item can be hot and should not be touched without taking care.
6		IEC60417 No.6042 ISO3864-B3.6	Caution, risk of electric shock To identify equipment that has risk of electric shock.
7		IEC60417 No.5957	For indoor use only To identify electrical equipment designed primarily for indoor use.
8		IEC60417 No.5926	Polarity of d.c. power connector To identify the positive and negative connections (the polarity) on a piece of equipment to which a d.c. power supply may be connected.

No.	Symbol mark	Approved standards	Description
9		—	The same as No.8.
10		IEC60417 No.5001B	Battery, general On battery powered equipment. To identify a device for instance a cover for the battery compartment, or the connector terminals.
11		IEC60417 No.5002	Positioning of cell To identify the battery holder itself and to identify the positioning of the cell(s) inside the battery holder.
12		—	The same as No.11.
13		IEC60417 No.5019	Protective earth To identify any terminal which is intended for connection to an external conductor for protection against electric shock in case of a fault, or the terminal of a protective earth electrode.
14		IEC60417 No.5017	Earth To identify an earth (ground) terminal in cases where neither the symbol No.13 is explicitly required.
15		IEC60417 No.5032	Alternating current To indicate on the rating plate that the equipment is suitable for alternating current only; to identify relevant terminals.
16		IEC60417 No.5031	Direct current To indicate on the rating plate that the equipment is suitable for direct current only; to identify relevant terminals.

No.	Symbol mark	Approved standards	Description
17		IEC60417 No.5172	Class II equipment To identify equipment meeting the safety requirements specified for Class II equipment according to IEC 61140.
18		ISO 3864	General prohibition To identify actions or operations that are prohibited.
19		ISO 3864	Contact prohibition To indicate injury that could occur due to touching a specific part of the equipment.
20		—	Never look into the optical lens while the projector is on.
21		—	To indicate that the marked item don't place anything on projector.
22		ISO3864 IEC60825-1	Caution, laser radiation To indicate the equipment has a laser radiation part.
23		ISO 3864	Disassembly prohibition To indicate a risk of injury, such as electric shock, if the equipment is disassembled.

This section briefly explains the difficult terms that are not explained in the text of this guide. For details, refer to other commercially available publications.

AMX Device Discovery	AMX Device Discovery is a technology developed by AMX to facilitate AMX control systems for easy operation of the target equipment. Epson have implemented this protocol technology, and have provided a setting to enable the protocol function (ON). See the AMX Web site for more details. URL http://www.amx.com/
Aspect Ratio	The ratio between an image's length and its height. Screens with a horizontal:vertical ratio of 16:9, such as HDTV screens, are known as wide screens. SDTV and general computer displays have an aspect ratio of 4:3.
Component Video	A method that separates the video signal into a luminance component (Y), and a blue minus luminance (Cb or Pb) and a red minus luminance (Cr or Pr).
Composite Video	A method that combines the video signal into a luminance component and a color component for transmission down a single cable.
Contrast	The relative brightness of the light and dark areas of an image can be increased or decreased to make text and graphics stand out more clearly, or to make them appear softer. Adjusting this particular property of an image is called contrast adjustment.
DHCP	An abbreviation of Dynamic Host Configuration Protocol, this protocol automatically assigns an IP address to equipment connected to a network.
Gateway Address	This is a server (router) for communicating across a network (subnet) divided according to subnet mask.

HDCP	HDCP is an abbreviation for High-bandwidth Digital Content Protection. It is used to prevent illegal copying and protect copyrights by encrypting digital signals sent over DVI and HDMI ports. Because the HDMI port on this projector supports HDCP, it can project digital images protected by HDCP technology. However, the projector may not be able to project images protected with updated or revised versions of HDCP encryption.
HDTV	An abbreviation for High-Definition Television that refers to high-definition systems which satisfy the following conditions: <ul style="list-style-type: none"> • Vertical resolution of 720p or 1080i or greater (p = Progressive, i = Interlace) • Screen aspect ratio of 16:9
Infrastructure mode	A method for wireless LAN connection in which devices communicate through access points.
Interlace	Transmits information needed to create one screen by sending every other line, starting from the top of the image and working down to the bottom. Images are more likely to flicker because one frame is displayed every other line.
IP Address	A number to identify a computer connected to a network.
MHL	An abbreviation for Mobile High-definition Link, a standard for connection interfaces aimed at mobile devices such as smartphones and tablets. Images can be transferred at high quality and at high speeds without compressing the digital signal, and also charges connected devices.
Progressive	Projects information to create one screen at a time, displaying the image for one frame. Even though the number of scan lines is the same, the amount of flicker in images decreases because the volume of information has doubled compared with an interlace system.

Refresh Rate	<p>The light-emitting element of a display maintains the same luminosity and color for an extremely short time.</p> <p>Because of this, the image must be scanned many times per second to refresh the light-emitting element.</p> <p>The number of refresh operations per second is called the Refresh rate and is expressed in hertz (Hz).</p>
SDTV	An abbreviation for Standard Definition Television that refers to standard television systems which do not satisfy the conditions for HDTV High-Definition Television.
SNMP	An abbreviation for Simple Network Management Protocol, which is the protocol for monitoring and controlling devices such as routers and computers connected to a TCP/IP network.
sRGB	An international standard for color intervals that was formulated so that colors that are reproduced by video equipment can be handled easily by computer operating systems (OS) and the Internet. If the connected source has an sRGB mode, set both the projector and the connected signal source to sRGB.
SSID	SSID is identification data for connecting to another device on a wireless LAN. Wireless communication is possible between devices with the same SSID.
Subnet Mask	This is a numerical value that defines the number of bits used for the network address on a divided network (subnet) from the IP address.
SVGA	A screen size standard with a resolution of 800 (horizontal) × 600 (vertical) dots.
SXGA	A screen size standard with a resolution of 1,280 (horizontal) × 1,024 (vertical) dots.
Sync.	<p>The signals output from computers have a specific frequency.</p> <p>If the projector frequency does not match this frequency, the resulting images are not of a good quality.</p> <p>The process of matching the phases of these signals (the relative position of the crests and the troughs in the signal) is called Synchronization.</p> <p>If the signals are not synchronized, flickering, blurriness, and horizontal interference occur.</p>

Tracking	<p>The signals output from computers have a specific frequency.</p> <p>If the projector frequency does not match this frequency, the resulting images are not of a good quality.</p> <p>The process of matching the frequency of these signals (the number of crests in the signal) is called Tracking.</p> <p>If Tracking is not carried out correctly, wide vertical stripes appear in the signal.</p>
Trap IP Address	This is the IP address for the destination computer used for error notification in SNMP.
VGA	A screen size standard with a resolution of 640 (horizontal) × 480 (vertical) dots.
XGA	A screen size standard with a resolution of 1,024 (horizontal) × 768 (vertical) dots.
WXGA	A screen size standard with a resolution of 1,280 (horizontal) × 768 (vertical) dots.
WUXGA	A screen size standard with a resolution of 1,920 (horizontal) × 1,200 (vertical) dots.

Check these sections for important notices about your projector.

► **Related Links**

- "FCC Compliance Statement" [p.164](#)
- "Indication of the manufacturer and the importer in accordance with requirements of EU directive" [p.165](#)
- "Restriction of Use" [p.165](#)
- "Operating System References" [p.165](#)
- "Trademarks" [p.165](#)
- "Copyright Notice" [p.166](#)
- "Copyright Attribution" [p.166](#)

FCC Compliance Statement

DECLARATION of CONFORMITY

According to 47CFR, Part 2 and 15
Class B Personal Computers and Peripherals; and/or
CPU Boards and Power Supplies used with Class B Personal Computers

We: Epson America, Inc.

Located at: 3840 Kilroy Airport Way MS: 3-13 Long Beach, CA 90806

Tel: 562-981-3840

Declare under sole responsibility that the product identified herein, complies with 47CFR Part 2 and 15 of the FCC rules as a Class B digital device. Each product marketed, is identical to the representative unit tested and found to be compliant with the standards. Records maintained continue to reflect the equipment being produced can be expected to be within the variation accepted, due to quantity production and testing on a statistical basis as required by 47CFR 2.909. Operation is subject to the following two conditions : (1) this device may not cause harmful interference, and (2) this device must accept any interference received, including interference that may cause undesired operation.

Trade Name: EPSON

Type of Product: LCD Projector

Model:

H716C/H717C/H718C/H719C/H720C/H721C/H722C/H723C/H730C/H763C/H764C

FCC Compliance Statement For United States Users

This equipment has been tested and found to comply with the limits for a Class B digital device, pursuant to Part 15 of the FCC Rules. These limits are designed to provide reasonable protection against harmful interference in a residential installation. This equipment generates, uses, and can radiate radio frequency energy and, if not installed and used in accordance with the instructions, may cause harmful interference to radio communications. However, there is no guarantee that interference will not occur in a particular installation. If this equipment does cause interference to radio and television reception, which can be determined by turning the equipment off and on, the user is encouraged to try to correct the interference by one or more of the following measures.

- Reorient or relocate the receiving antenna.
- Increase the separation between the equipment and receiver.
- Connect the equipment into an outlet on a circuit different from that to which the receiver is connected.
- Consult the dealer or an experienced radio/TV technician for help.

WARNING

The connection of a non-shielded equipment interface cable to this equipment will invalidate the FCC Certification or Declaration of this device and may cause interference levels which exceed the limits established by the FCC for this equipment. It is the responsibility of the user to obtain and use a shielded equipment interface cable with this device. If this equipment has more than one interface connector, do not leave cables connected to unused interfaces. Changes or modifications not expressly approved by the manufacturer could void the user's authority to operate the equipment.

Indication of the manufacturer and the importer in accordance with requirements of EU directive

Manufacturer: SEIKO EPSON CORPORATION
Address: 3-5, Owa 3-chome, Suwa-shi, Nagano-ken 392-8502 Japan
Telephone: 81-266-52-3131
<http://www.epson.com/>

Importer: EPSON EUROPE B.V.
Address: Atlas Arena, Asia Building, Hoogoorddreef 5,1101 BA Amsterdam Zuidoost
The Netherlands
Telephone: 31-20-314-5000
<http://www.epson.com/europe.html>

Restriction of Use

When this product is used for applications requiring high reliability/safety such as transportation devices related to aviation, rail, marine, automotive etc.; disaster prevention devices; various safety devices etc; or functional/precision devices etc, you should use this product only after giving consideration to including fail-safes and redundancies into your design to maintain safety and total system reliability. Because this product was not intended for use in applications requiring extremely high reliability/safety such as aerospace equipment, main communication equipment, nuclear power control equipment, or medical equipment related to direct medical care etc, please make your own judgment on this product's suitability after a full evaluation.

Operating System References

- Microsoft® Windows® 2000 operating system
- Microsoft® Windows® XP operating system
- Microsoft® Windows® Vista® operating system

- Microsoft® Windows® 7 operating system
- Microsoft® Windows® 8 operating system
- Microsoft® Windows® 8.1 operating system

In this guide, the operating systems above are referred to as "Windows 2000", "Windows XP", "Windows Vista", "Windows 7", "Windows 8", and "Windows 8.1". Furthermore, the collective term Windows may be used to refer to Windows 2000, Windows XP, Windows Vista, Windows 7, Windows 8, and Windows 8.1.

- Mac OS X 10.3.x
- Mac OS X 10.4.x
- Mac OS X 10.5.x
- Mac OS X 10.6.x
- OS X 10.7.x
- OS X 10.8.x
- OS X 10.9.x
- OS X 10.10.x

In this guide, the operating systems above are referred to as "Mac OS X 10.3.x", "Mac OS X 10.4.x", "Mac OS X 10.5.x", "Mac OS X 10.6.x", "OS X 10.7.x", "OS X 10.8.x", "OS X 10.9.x", and "OS X 10.10.x". Furthermore, the collective term "OS X" is used to refer to them all.

Trademarks

EPSON is a registered trademark, EXCEED YOUR VISION, ELPLP and their logos are registered trademarks or trademarks of Seiko Epson Corporation.

Mac, Mac OS, and OS X, are trademarks of Apple Inc.

Microsoft, Windows, Windows Vista, PowerPoint, and the Windows logo are trademarks or registered trademarks of Microsoft Corporation in the United States and/or other countries.

WPA™ and WPA2™ are registered trademarks of Wi-Fi Alliance.

App Store is a service mark of Apple Inc.

Google play is a trademark of Google Inc.

HDMI and High-Definition Multimedia Interface are the trademarks or registered trademarks of HDMI Licensing LLC. 

MHL, the MHL logo, and Mobile High-Definition Link are the trademarks or registered trademarks of MHL and LLC in the United States and/or other countries.

"QR Code" is a registered trademark of DENSO WAVE INCORPORATED.

Other product names used herein are also for identification purposes only and may be trademarks of their respective owners. Epson disclaims any and all rights in those marks.

©SEIKO EPSON CORPORATION 2015. All rights reserved.

2015.4 412878300/412879000EN

Copyright Notice

All rights reserved. No part of this publication may be reproduced, stored in a retrieval system, or transmitted in any form or by any means, electronic, mechanical, photocopying, recording, or otherwise, without the prior written permission of Seiko Epson Corporation. No patent liability is assumed with respect to the use of the information contained herein. Neither is any liability assumed for damages resulting from the use of the information contained herein.

Neither Seiko Epson Corporation nor its affiliates shall be liable to the purchaser of this product or third parties for damages, losses, costs, or expenses incurred by the purchaser or third parties as a result of: accident, misuse, or abuse of this product or unauthorized modifications, repairs, or alterations to this product, or (excluding the U.S.) failure to strictly comply with Seiko Epson Corporation's operating and maintenance instructions.

Seiko Epson Corporation shall not be liable against any damages or problems arising from the use of any options or any consumable products other than those designated as Original Epson Products or Epson Approved Products by Seiko Epson Corporation.

The contents of this guide may be changed or updated without further notice.

Illustrations in this guide and the actual projector may differ.

Copyright Attribution

This information is subject to change without notice.

Free Manuals Download Website

<http://myh66.com>

<http://usermanuals.us>

<http://www.somanuals.com>

<http://www.4manuals.cc>

<http://www.manual-lib.com>

<http://www.404manual.com>

<http://www.luxmanual.com>

<http://aubethermostatmanual.com>

Golf course search by state

<http://golfingnear.com>

Email search by domain

<http://emailbydomain.com>

Auto manuals search

<http://auto.somanuals.com>

TV manuals search

<http://tv.somanuals.com>