

EF-100WATV/EF-100BATV User's Guide

Contents

EF-100WATV/EF-100BATV User's Guide	7
Introduction to Your Projector	8
Projector Features.....	8
Product Box Contents.....	9
Additional Components	10
Optional Equipment and Replacement Parts.....	10
Warranty and Registration Information (U.S. and Canada)	11
Warranty and Registration Information (Latin America).....	11
Notations Used in the Documentation	12
Where to Go for Additional Information	12
Projector Part Locations	12
Projector Parts - Front/Top	13
Projector Parts - Rear	15
Projector Parts - Base.....	16
Projector Parts - Control Panel	17
Projector Parts - Remote Control.....	18
Setting Up the Projector	22
Projector Placement.....	22
Projector Setup and Installation Options	22
Projection Distance.....	24
Projector Connections	28
Connecting the Streaming Device	29
Connecting to an HDMI Video Source	32
Connecting Headphones.....	34
Connecting to a Bluetooth Audio Device	36
Installing Batteries in the Remote Control	37
Using Basic Projector Features	39
Turning On the Projector	39
Turning Off the Projector	41
Remote Control Operation	42

Pairing the Projector Remote Control.....	42
Selecting the Language for the Projector Menus.....	43
Projection Modes	44
Changing the Projection Mode Using the Menus.....	44
Adjusting the Image Height	45
Image Shape.....	46
Correcting Image Shape with H/V Keystone.....	46
Correcting Image Shape with Quick Corner	48
Focusing the Image Using the Focus Lever	50
Resizing the Image Using Zoom	51
Image Aspect Ratio	52
Changing the Image Aspect Ratio	52
Available Image Aspect Ratios	53
Color Mode.....	54
Changing the Color Mode.....	54
Available Color Modes.....	55
Turning On Automatic Luminance Adjustment	55
Adjusting Light Output (Brightness).....	56
Saving Settings to Memory and Using Saved Settings	57
Controlling the Volume with the Volume Buttons.....	59
Adjusting Projector Features	60
Operating Connected Devices Using the HDMI Link Features.....	60
Shutting Off the Picture and Sound Temporarily	62
Projector Security Features.....	62
Locking the Projector's Buttons	62
Unlocking the Projector's Buttons	64
Installing a Security Cable	65
Adjusting the Menu Settings	66
Using the Projector's Menus.....	66
Image Quality Settings - Image Menu	67
Projector Feature Settings - Settings Menu.....	70
Projector Information Display - Info Menu	75
Projector Reset Options - Reset Menu	76

Maintaining and Transporting the Projector	77
Projector Maintenance	77
Cleaning the Projection Window	77
Cleaning the Projector Case	78
Air Filter and Vent Maintenance	78
Cleaning the Air Filter and Vents	79
Replacing the Air Filter	80
Replacing the Remote Control Batteries	81
Transporting the Projector	83
Solving Problems	84
Projection Problem Tips	84
Projector Light Status	85
Solving Image or Sound Problems	88
Solutions When No Image Appears	88
Solutions When "No Signal" Message Appears	89
Displaying From a PC Laptop	90
Displaying From a Mac Laptop	90
Solutions When the Image is Not Rectangular	91
Solutions When Only a Partial Image Appears	91
Solutions When the Image Contains Noise or Static	92
Solutions When the Image is Fuzzy or Blurry	92
Solutions When the Image Brightness or Colors are Incorrect	93
Solutions to Sound Problems	93
Solutions to Bluetooth Audio Problems	94
Solving Projector or Remote Control Operation Problems	95
Solutions to Projector Power or Shut-Off Problems	95
Solutions to Streaming Device Problems	96
Solutions to Remote Control Problems	96
Solutions to HDMI Link Problems	97
Where to Get Help (U.S. and Canada)	97
Where to Get Help (Latin America)	98
Technical Specifications	101
General Projector Specifications	101

Projector Light Source Specifications.....	102
Projector Remote Control Specifications.....	103
Projector Dimension Specifications.....	103
Projector Electrical Specifications	106
Projector Environmental Specifications.....	106
Bluetooth Specifications.....	107
Streaming Device Specifications.....	107
Projector Safety and Approvals Specifications.....	108
Supported Video Display Formats.....	108
Notices	110
Recycling.....	110
Important Safety Information	110
Laser Safety Information	110
Important Safety Instructions.....	113
Restriction of Use	116
List of Safety Symbols.....	116
FCC Compliance Statement.....	121
Binding Arbitration and Class Waiver.....	122
Trademarks.....	125
Copyright Notice.....	125
A Note Concerning Responsible Use of Copyrighted Materials.....	126
Copyright Attribution	126

EF-100WATV/EF-100BATV User's Guide

Welcome to the EF-100WATV/EF-100BATV *User's Guide*.

For a printable PDF copy of this guide, [click here](#).

Introduction to Your Projector

Refer to these sections to learn more about your projector and this manual.

[Projector Features](#)

[Notations Used in the Documentation](#)

[Where to Go for Additional Information](#)

[Projector Part Locations](#)

Projector Features

The EF-100WATV/EF-100BATV projector includes these special features:

Bright, high-resolution projection system

- Up to 2000 lumens of color brightness (color light output) and white brightness (white light output)

Note: Color brightness (color light output) and white brightness (white light output) will vary depending on usage conditions. Color light output measured in accordance with IDMS 15.4; white light output measured in accordance with ISO 21118.

- High-definition mini cinema lens
- Advanced 3LCD technology
- Epson microlaser array projection technology
- Up to 150 inches (12.5 ft diagonal) projected image size (no screen required)

Flexible connectivity

- HDMI port for streaming device or other HDMI sources
- Small, portable design
- Audio out port for connecting headphones or external speakers
- Audiophile BassReflex built-in speaker
- aptX Bluetooth connectivity
- One remote controls projector and streaming device

Innovative display and operation features

- Long-life laser light source

- More than 2,500,000:1 contrast ratio and Dynamic Contrast control for sharp, detailed images
- Epson's Direct Power On feature allows for quick and easy setup

[Product Box Contents](#)

[Additional Components](#)

[Optional Equipment and Replacement Parts](#)

[Warranty and Registration Information \(U.S. and Canada\)](#)

[Warranty and Registration Information \(Latin America\)](#)

Parent topic: [Introduction to Your Projector](#)

Product Box Contents

Save all the packaging in case you need to ship the projector. Always use the original packaging (or equivalent) when shipping.

Make sure your projector box included all of these parts:

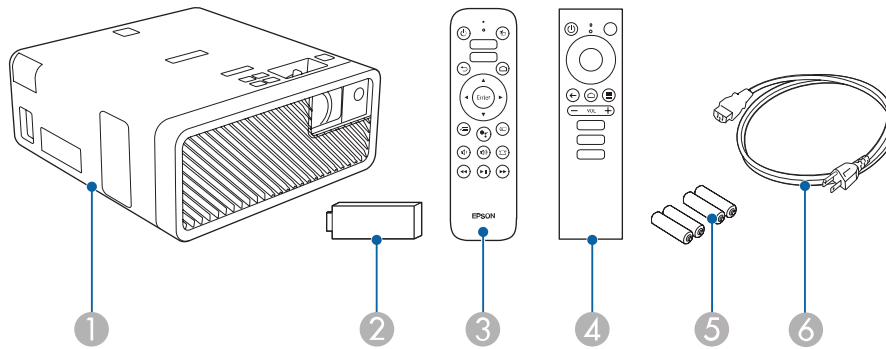

- 1 Projector
- 2 Streaming device
- 3 Projector remote control
- 4 Remote control for Android TV
- 5 Remote control batteries (4 AAA alkaline)
- 6 Power cord

Parent topic: [Projector Features](#)

Additional Components

Depending on how you plan to use the projector, you may need to obtain additional components.

Note: To connect a Mac that does not include a compatible HDMI output port, you need to obtain an adapter that allows you to connect to the HDMI port on the projector. Contact Apple for compatible HDMI adapter options. To connect a smartphone or tablet, you may need to obtain an adapter that allows you to connect to the projector. This allows you to mirror your smartphone or tablet screens, watch movies, and more. Contact your device manufacturer for compatible adapter options.

Note: The projector's HDMI port does not support MHL.

Unless listed as available from Epson in this table, see your local computer or electronics dealer for purchase information.

Signal or connection type	Additional component necessary
HDMI	Compatible HDMI cable Available for purchase from Epson or an authorized Epson reseller. Note: Older Mac computers (2009 and earlier) may not support HDMI audio.
Audio out	Commercially available 3.5 mm mini jack stereo cable

Parent topic: [Projector Features](#)

Related tasks

[Connecting to an HDMI Video Source](#)

Optional Equipment and Replacement Parts

U.S. and Canada: You can purchase screens, other optional accessories, and replacement parts from an Epson authorized reseller. To find the nearest reseller, call 800-GO-EPSON (800-463-7766) in the U.S. or 800-807-7766 in Canada. Or you can purchase online at epsonstore.com (U.S. sales) or epsonstore.ca (Canadian sales).

Latin America: You can purchase screens, other optional accessories, and replacement parts from an Epson authorized reseller. To find the nearest reseller, go to epson.com.jm. Or you can contact your nearest sales office as described in "Where to Get Help."

Note: Availability of accessories varies by country.

Epson offers the following optional accessories and replacement parts for your projector:

Option or part	Part number
Ceiling mount (ELPMB60)	V12H963010
Lighting track mount (ELPMB61)	V12H964020
Air filter set (ELPAF57)	V13H134A57

In addition to the accessories listed above, extended service plans are available.

Parent topic: [Projector Features](#)

Related references

[Where to Get Help \(U.S. and Canada\)](#)

[Where to Get Help \(Latin America\)](#)

Related tasks

[Replacing the Air Filter](#)

Warranty and Registration Information (U.S. and Canada)

Your projector comes with a basic warranty that lets you project with confidence. For details, see the warranty that came with your projector.

In addition, Epson offers free Extra Care Road Service. In the unlikely event of an equipment failure, you won't have to wait for your unit to be repaired. Instead, Epson will ship you a replacement unit anywhere in the United States, Canada, or Puerto Rico. See the Extra Care Road Service brochure for details.

Note: Availability varies by region.

Register your product online at this site: epson.com/webreg.

Registering also lets you receive special updates on new accessories, products, and services.

Parent topic: [Projector Features](#)

Warranty and Registration Information (Latin America)

Your projector comes with a basic warranty that lets you project with confidence. For details, see the warranty that came with your projector.

Register your product online at latin.epson.com/support, search for your product, and select **Register**. Registering also lets you receive special updates on new accessories, products, and services.

Parent topic: [Projector Features](#)

Notations Used in the Documentation

Follow the guidelines in these notations as you read your documentation:

- **Warnings** must be followed carefully to avoid bodily injury.
- **Cautions** must be observed to avoid damage to your equipment.
- **Notes** contain important information about your projector.
- **Tips** contain additional projection information.

Parent topic: [Introduction to Your Projector](#)

Where to Go for Additional Information

Need quick help on using your projector? Here's where to look for help:

- epson.com/support (U.S.), epson.ca/support (Canada), or epson.com.jm/support (Caribbean)

View FAQs (frequently asked questions) and e-mail your questions to Epson technical support 24 hours a day.

- If you still need help after checking this manual and any other sources listed here, you can use the Epson PrivateLine Support service to get help fast (U.S. and Canada only). For details, see "Where to Get Help."

Parent topic: [Introduction to Your Projector](#)

Related references

[Where to Get Help \(U.S. and Canada\)](#)

[Where to Get Help \(Latin America\)](#)

Projector Part Locations

Check the projector part illustrations to learn about the parts on your projector.

[Projector Parts - Front/Top](#)

[Projector Parts - Rear](#)

[Projector Parts - Base](#)

[Projector Parts - Control Panel](#)

Projector Parts - Remote Control

Parent topic: Introduction to Your Projector

Projector Parts - Front/Top

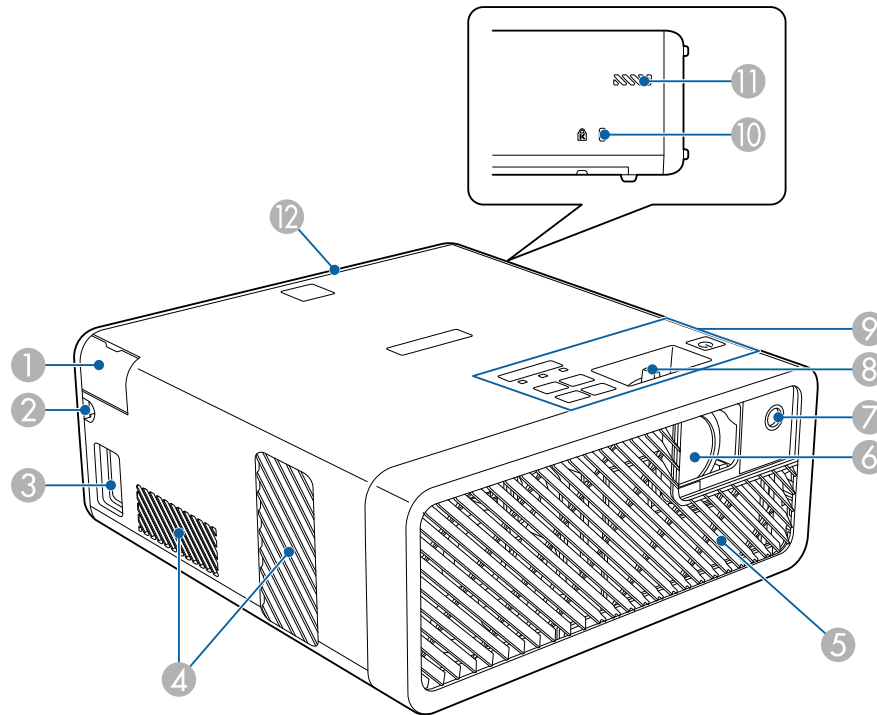

- 1 Audio out port cover
- 2 HDMI cable path
- 3 AC inlet
- 4 Air exhaust vents
- 5 Air intake vent
- 6 Projection window
- 7 Remote receiver

- 8 Focus lever
- 9 Control panel
- 10 Kensington security slot
- 11 Air intake vent
- 12 Rear cover

Warning: While projecting, do not put your face or hands near the air exhaust vents, and do not place objects that may become warped or damaged by heat near the vents. Hot air from the air exhaust vents could cause burns or other injuries, or warping of projector parts.

Parent topic: [Projector Part Locations](#)

Related references

[Projector Light Status](#)

Related tasks

[Connecting to an HDMI Video Source](#)

[Connecting Headphones](#)

[Focusing the Image Using the Focus Lever](#)

[Installing a Security Cable](#)

[Cleaning the Air Filter and Vents](#)

Projector Parts - Rear

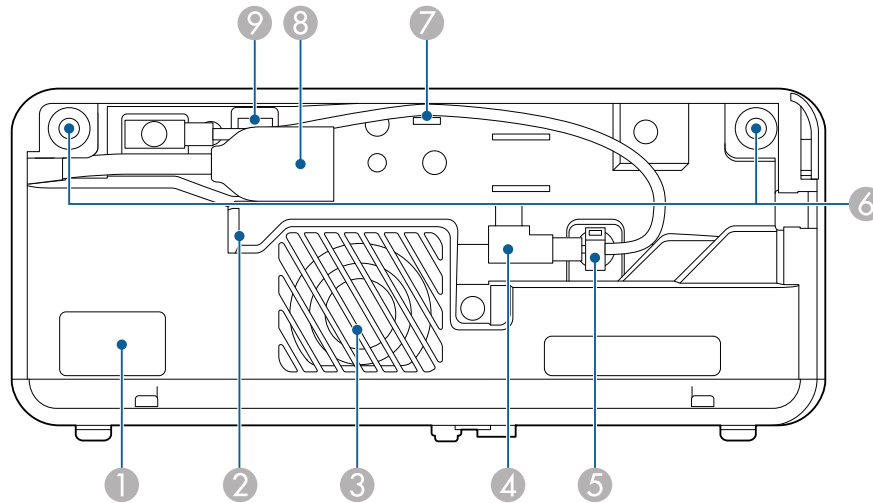

- 1 Remote receiver
- 2 Air exhaust vent
- 3 Speaker
- 4 USB power cable
- 5 Cable clamp
- 6 Rear cover slots
- 7 Cable hook
- 8 HDMI extension cable
- 9 Service port

Parent topic: [Projector Part Locations](#)

Related tasks

[Connecting the Streaming Device](#)

[Connecting to an HDMI Video Source](#)

Projector Parts - Base

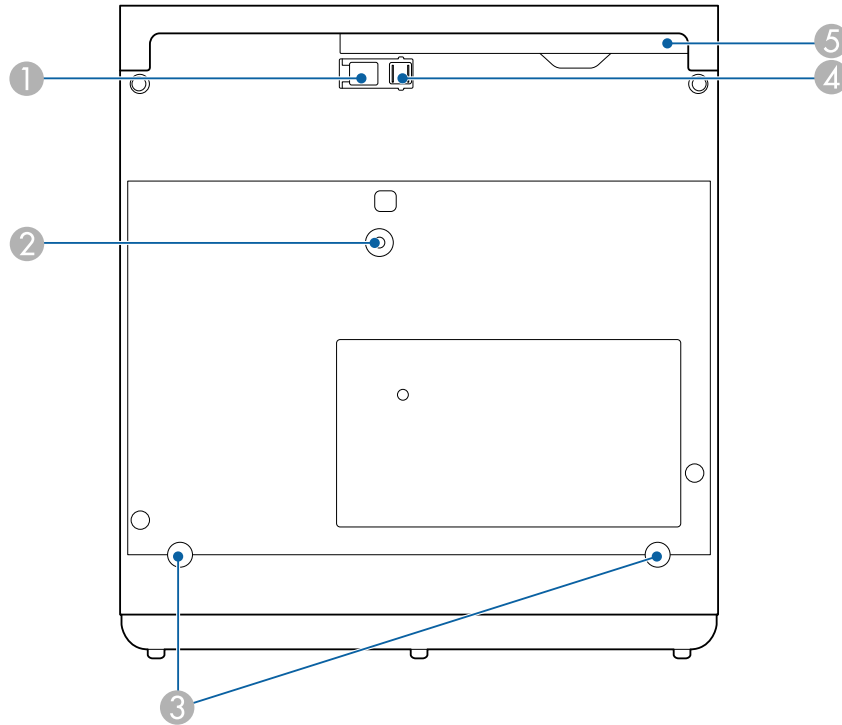

- 1 Foot release lever
- 2 Optional ceiling/lighting track mount hole
- 3 Rear feet (removable for mounting)
- 4 Front adjustable foot
- 5 Air filter cover

Note: Use M4×9mm screws for mounting the projector.

Parent topic: [Projector Part Locations](#)

Related references

[Optional Equipment and Replacement Parts](#)

Related tasks

[Adjusting the Image Height](#)

Projector Parts - Control Panel

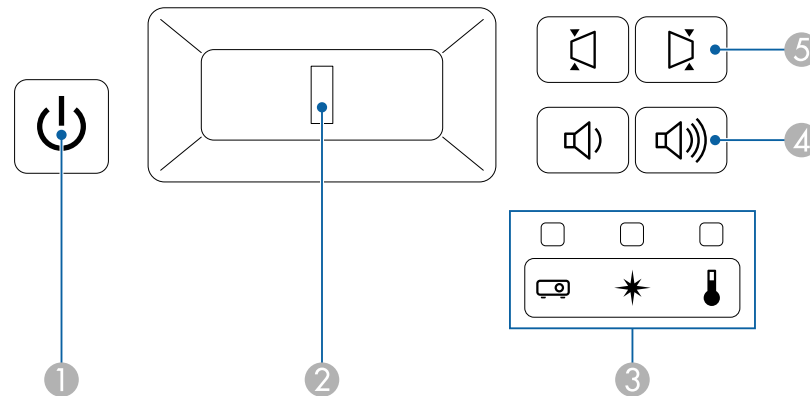

- 1 ⏻ power button and light
- 2 Focus lever
- 3 Status, laser, and temperature lights
- 4 Volume buttons
- 5 Horizontal keystone buttons

Parent topic: [Projector Part Locations](#)

Related references

[Projector Light Status](#)

Related tasks

[Focusing the Image Using the Focus Lever](#)

[Controlling the Volume with the Volume Buttons](#)

[Correcting Image Shape with H/V Keystone](#)







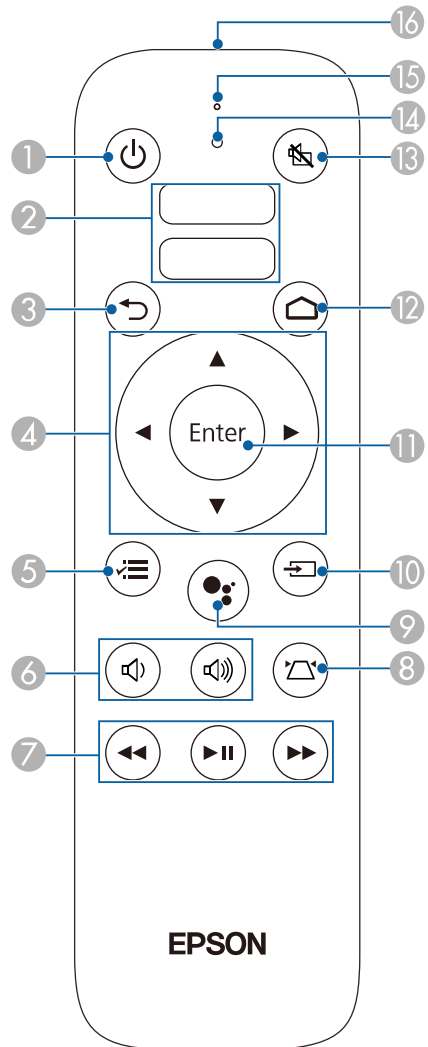



[Turning On the Projector](#)

Projector Parts - Remote Control

Projector remote control





1  power button

- 2 Apps buttons
- 3  return button (cancels/exits function)
- 4 Arrow buttons (move through on-screen options)
- 5  menu button (accesses projector menus)
- 6  volume up and  volume down buttons
- 7  rewind,  play/pause, and  fast forward buttons (control connected streaming device)
- 8  keystone button (corrects image distortion)
- 9  mic button (operates Android TV using voice commands)
- 10 Not applicable
- 11 **Enter** button (selects options)
- 12  home button (displays Android TV home screen)
- 13  A/V mute button (turns off picture and sound)
- 14 Command light
- 15 Microphone
- 16 Remote control emitter

Note: This remote control is used to control the projector and the connected streaming device after it has been paired to the projector.

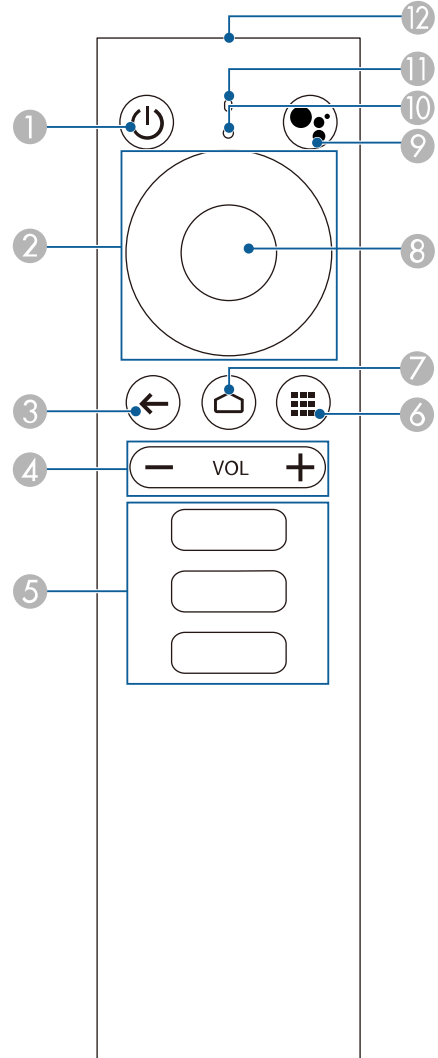
Remote control for Android TV



- 1  power button
- 2 Directional pad

- 3 Back button
- 4 Volume buttons
- 5 Apps buttons
- 6 Installed apps button
- 7 Home button
- 8 Enter button
- 9  mic button (operates Android TV using voice commands)
- 10 Command indicator
- 11 Microphone
- 12 Remote control emitter

Note: This remote control is used to control the streaming device only if it is connected to a different device or projector. You do not need to use this remote control in addition to the projector remote control.

Parent topic: [Projector Part Locations](#)

Related tasks

[Using the Projector's Menus](#)

[Controlling the Volume with the Volume Buttons](#)

[Correcting Image Shape with H/V Keystone](#)

[Changing the Color Mode](#)

[Pairing the Projector Remote Control](#)

Setting Up the Projector

Follow the instructions in these sections to set up your projector for use.

[Projector Placement](#)

[Projector Connections](#)

[Installing Batteries in the Remote Control](#)

Projector Placement

You can place the projector on almost any flat surface to project an image.

You can also install the projector in a ceiling mount or on a floor stand if you want to use it in a fixed location.

There is no vertical or horizontal limit to how the projector can be installed.

Keep these considerations in mind as you select a projector location:

- Place the projector on a sturdy, level surface or install it using a compatible mount.
- Leave plenty of space around and under the projector for ventilation, and do not place it on top of or next to anything that could block the vents.
- Place the projector parallel to the screen.
- Position the projector within reach of a grounded electrical outlet or extension cord.

[Projector Setup and Installation Options](#)

[Projection Distance](#)

Parent topic: [Setting Up the Projector](#)

Projector Setup and Installation Options

You can set up or install your projector in the following ways:

Front

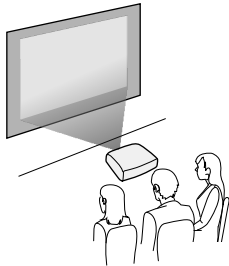

Rear

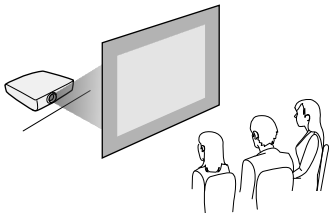

Front ceiling

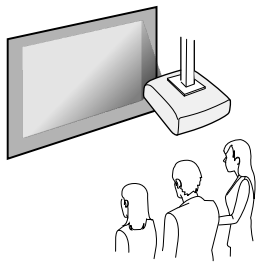

Rear ceiling

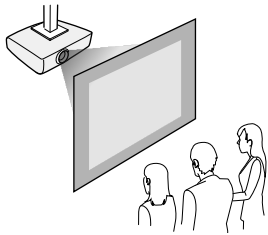

Toward the ceiling

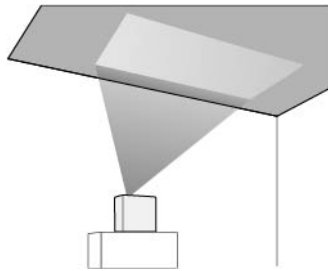

Note: Make sure the rear cover is securely attached.

Parent topic: [Projector Placement](#)

Projection Distance

The distance at which you place the projector from the screen determines the approximate size of the image. The image size increases the farther the projector is from the screen, but can vary depending on the zoom factor, aspect ratio, and other settings.

Use the tables here to determine approximately how far to place the projector from the screen based on the size of the projected image. (Conversion figures may have been rounded up or down.) You can also use the Projection Distance Calculator [here](#) (U.S.), [here](#) (Canada), or [here](#) (Caribbean).

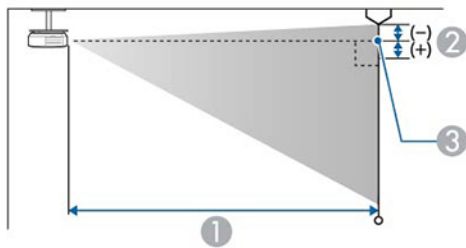
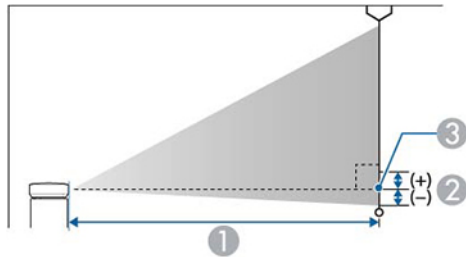

- 1 Projection distance
- 2 Distance from the center of the lens to the base of the screen
- 3 Center of lens

16:9 Aspect Ratio Image or Screen		
Screen or image size	Projection distance (1) Wide to Tele	Distance from center of lens to base of screen (2)
30 inches	26 to 36 inches (67 to 91 cm)	-0.79 inch (-2 cm)
40 inches	36 to 48 inches (91 to 123 cm)	-0.79 inch (-2 cm)

16:9 Aspect Ratio Image or Screen		
Screen or image size	Projection distance (1) Wide to Tele	Distance from center of lens to base of screen (2)
50 inches	45 to 61 inches (114 to 154 cm)	-1.18 inches (-3 cm)
60 inches	54 to 73 inches (138 to 186 cm)	-1.18 inches (-3 cm)
70 inches	64 to 86 inches (162 to 218 cm)	-1.57 inches (-4 cm)
80 inches	73 to 98 inches (185 to 250 cm)	-1.97 inches (-5 cm)
90 inches	82 to 111 inches (209 to 282 cm)	-1.97 inches (-5 cm)
100 inches	92 to 124 inches (233 to 314 cm)	-2.36 inches (-6 cm)
110 inches	101 to 136 inches* (256 to 346 cm)	-2.36 inches (-6 cm)
120 inches	110 to 149 inches* (280 to 378 cm)	-2.76 inches (-7 cm)
130 inches	120 to 161 inches* (304 to 410 cm)	-2.76 inches (-7 cm)

16:10 Aspect Ratio Image or Screen		
Screen or image size	Projection distance (1) Wide to Tele	Distance from center of lens to base of screen (2)
30 inches	26 to 35 inches (65 to 88 cm)	-1.57 inches (-4 cm)

16:10 Aspect Ratio Image or Screen		
Screen or image size	Projection distance (1) Wide to Tele	Distance from center of lens to base of screen (2)
40 inches	35 to 47 inches (88 to 119 cm)	-1.97 inches (-5 cm)
50 inches	44 to 59 inches (111 to 150 cm)	-2.36 inches (-6 cm)
60 inches	53 to 71 inches (134 to 181 cm)	-2.76 inches (-7 cm)
80 inches	71 to 96 inches (180 to 243 cm)	-3.94 inches (-10 cm)
90 inches	80 to 108 inches (203 to 274 cm)	-4.33 inches (-11 cm)
100 inches	89 to 120 inches (226 to 305 cm)	-4.72 inches (-12 cm)
120 inches	107 to 145 inches (272 to 368 cm)	-5.91 inches (-15 cm)
130 inches	116 to 157 inches* (295 to 399 cm)	-6.30 inches (-16 cm)
150 inches	134 to 181 inches* (341 to 461 cm)	-7.09 inches (-18 cm)

4:3 Aspect Ratio Image or Screen		
Screen or image size	Projection distance (1) Wide to Tele	Distance from center of lens to base of screen (2)
30 inches	29 to 39 inches (74 to 100 cm)	-1.57 inches (-4 cm)

4:3 Aspect Ratio Image or Screen		
Screen or image size	Projection distance (1) Wide to Tele	Distance from center of lens to base of screen (2)
40 inches	39 to 54 inches (100 to 136 cm)	-2.36 inches (-6 cm)
50 inches	50 to 67 inches (126 to 171 cm)	-2.76 inches (-7 cm)
60 inches	60 to 81 inches (152 to 206 cm)	-3.15 inches (-8 cm)
70 inches	70 to 95 inches (179 to 241 cm)	-3.94 inches (-10 cm)
80 inches	81 to 109 inches (205 to 276 cm)	-4.33 inches (-11 cm)
90 inches	91 to 122 inches (231 to 311 cm)	-4.72 inches (-12 cm)
100 inches	101 to 137 inches* (257 to 347 cm)	-5.51 inches (-14 cm)
110 inches	111 to 150 inches* (283 to 382 cm)	-5.91 inches (-15 cm)
120 inches	122 to 164 inches* (309 to 417 cm)	-6.69 inches (-17 cm)
130 inches	132 to 178 inches* (335 to 452 cm)	-7.09 inches (-18 cm)

*Epson cannot guarantee optimal focus performance for projection distances over 134 inches (340 cm).

Parent topic: [Projector Placement](#)

Projector Connections

See these sections to connect the projector to a variety of projection sources.

Caution: If you will use the projector at altitudes above 4921 feet (1500 m), turn on **High Altitude Mode** to ensure the projector's internal temperature is regulated properly.

[Connecting the Streaming Device](#)

[Connecting to an HDMI Video Source](#)

[Connecting Headphones](#)

[Connecting to a Bluetooth Audio Device](#)

Parent topic: [Setting Up the Projector](#)

Related references

[Additional Components](#)

[Projector Feature Settings - Settings Menu](#)

Connecting the Streaming Device

You can connect the streaming device included with your projector to the projector's HDMI port. Connecting the USB power cable provides power to the streaming device.

Note: To use video-on-demand or Android TV features through the streaming device, you must first pair the projector remote control to the projector.

1. Remove the rear cover from the projector.

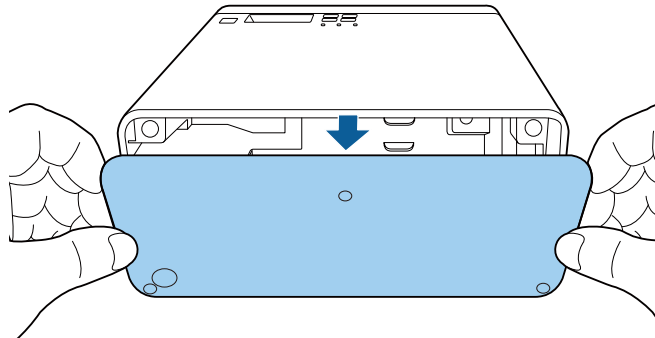

2. Open the USB power cable clamp.

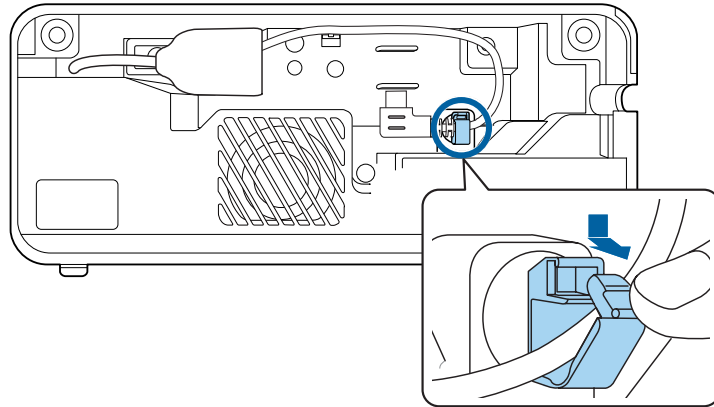

3. Connect the streaming device to the projector's HDMI extension cable.

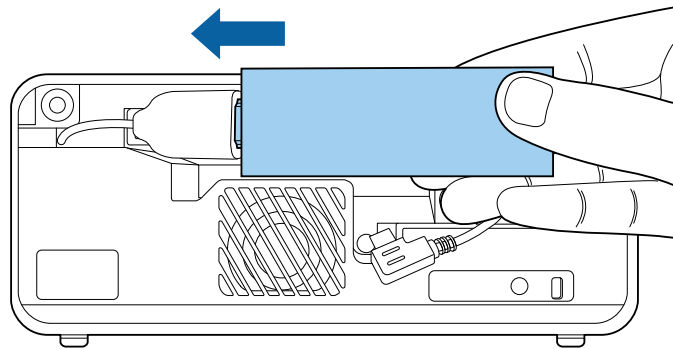

4. Connect the USB power cable to the streaming device's USB power port and fit the device securely inside the projector.

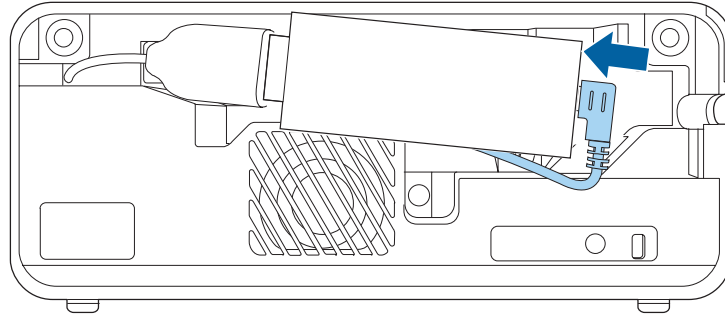

Caution: Do not force the streaming device into the projector; you may damage the projector and/or the device.

5. Make sure the device is securely connected as shown. Pass the USB power cable through the cable clamp, then close the cable clamp to secure the cable.

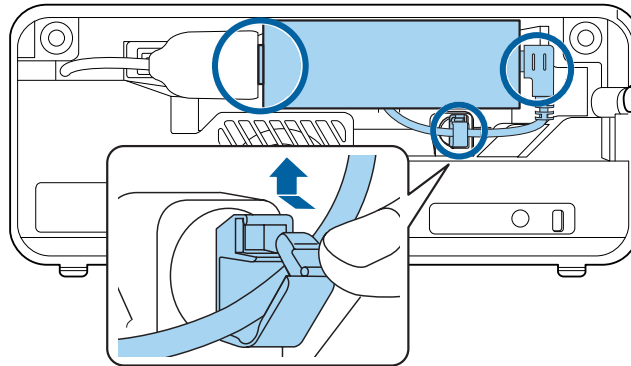

6. Replace the rear cover and push it into place.

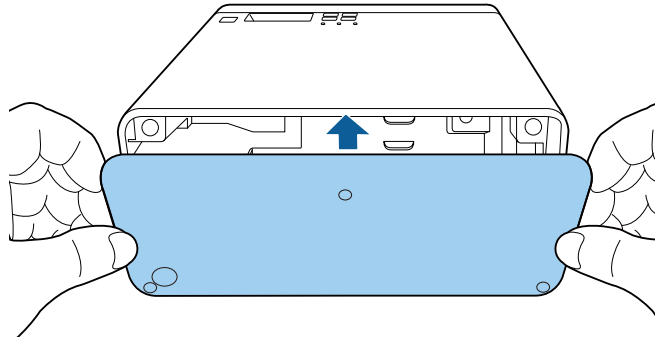

Parent topic: [Projector Connections](#)

Related tasks

[Pairing the Projector Remote Control](#)

Connecting to an HDMI Video Source

If your video source has an HDMI port, you can connect it to the projector using an HDMI cable. The video source's sound is output to the projector's speaker.

Note: You can also connect a computer or laptop to the projector using an HDMI cable.

Caution: Do not turn on the video source before connecting it to the projector; otherwise, you may damage the projector.

1. Remove the rear cover from the projector.

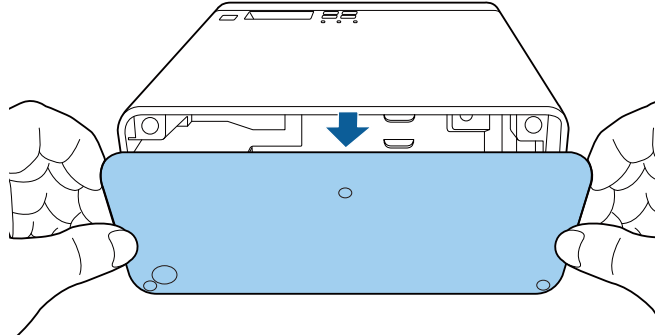

2. Connect one end of an HDMI cable to your video source's HDMI port.
3. Connect the other end of the HDMI cable to the projector's HDMI extension cable.

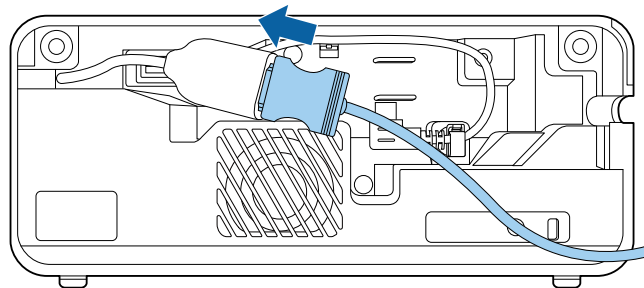

4. Pass the HDMI cable through the cable path as shown.

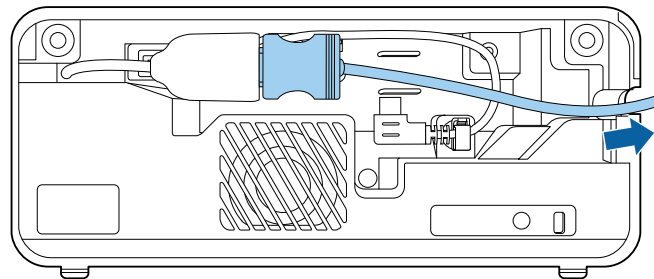

5. Replace the rear cover and push it into place.

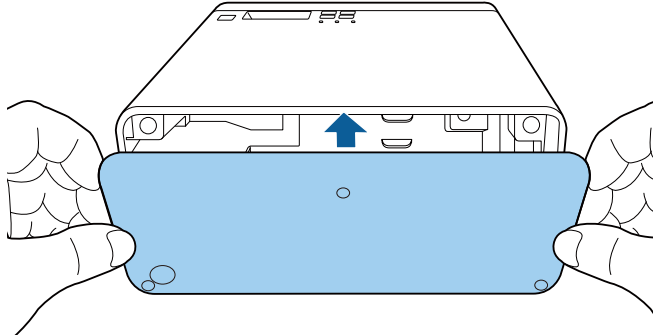

Parent topic: [Projector Connections](#)

Related tasks

[Controlling the Volume with the Volume Buttons](#)

Connecting Headphones

You can connect headphones to the projector's audio out port. You can control the volume using the projector remote control.

Note: The projector's audio out port only supports 3.5mm stereo headphones. If you use any other type of headphones, audio may not be output normally.

1. Open the audio out port cover.

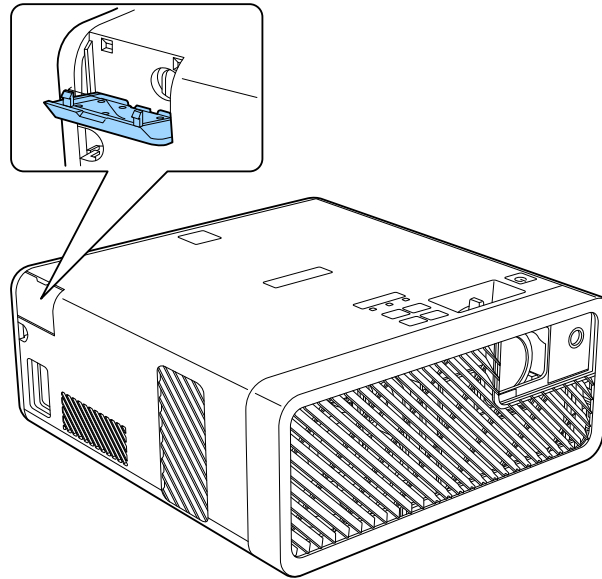

2. Insert the headphone jack into the audio out port.

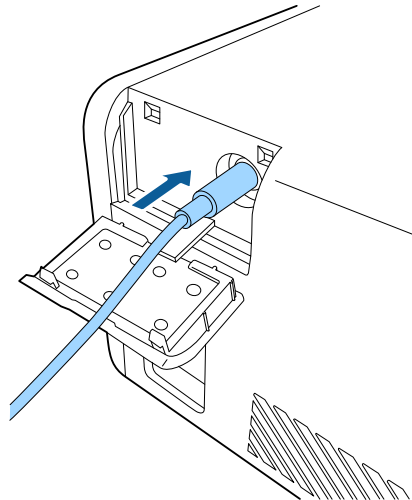

Parent topic: [Projector Connections](#)



Connecting to a Bluetooth Audio Device

You can connect your projector to Bluetooth audio devices such as speakers or headphones to output audio from a streaming device or other video source connected to the projector.

Note: The Bluetooth audio device must be A2DP compliant. There may be a slight delay in audio output. Bluetooth audio devices are not supported in some countries and regions.

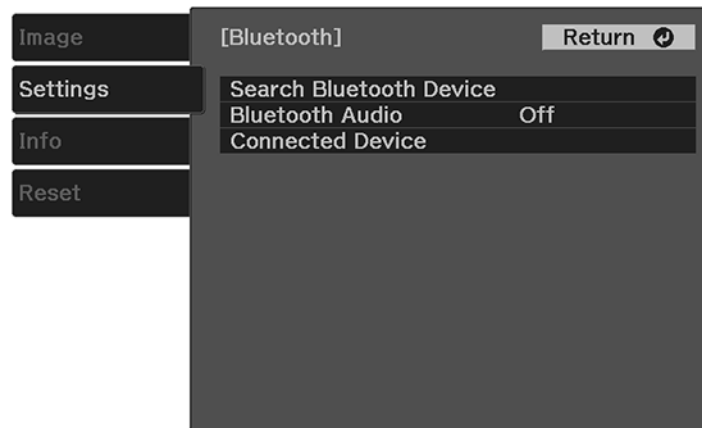
1. Turn on the projector.
2. Press and hold the  menu button on the projector remote control for about three seconds to display the **Bluetooth** menu.



3. Press the arrow buttons on the projector remote control to select the **Bluetooth Audio** setting and press **Enter**.
4. Select **On** and press **Enter**.
5. Make sure the Bluetooth audio device you want to connect to is in pairing or discovery mode (see your Bluetooth audio device manual for details).
6. Select **Search Bluetooth Device** and press **Enter** to display a list of available devices.
7. Select the device you want to connect to and press **Enter**.
8. Press the  menu button to exit the menu or the  return button to return to the previous screen.

The next time you turn on the projector, the last connected device is automatically connected. To change the connected device, repeat these steps.

Parent topic: [Projector Connections](#)

Installing Batteries in the Remote Control

The remote control uses the two AAA batteries that came with the projector.

Caution: Use only the type of batteries specified in this manual. Do not install batteries of different types, or mix new and old batteries.

1. Remove the battery cover.

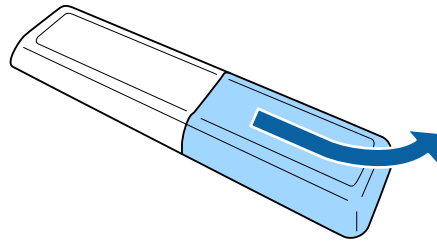

2. Insert the batteries with the + and – ends facing as shown.

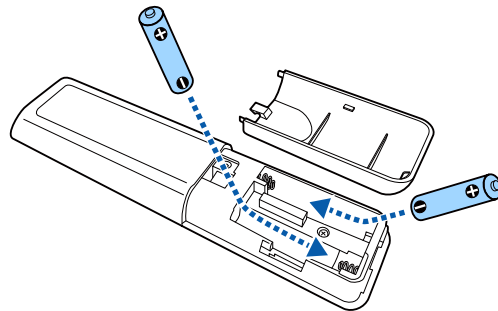

Warning: Make sure the batteries are inserted in the correct positions. If the batteries are not inserted correctly, they could explode or leak, causing a fire, injury, or damage to the product.

3. Replace the battery cover and press it down until it clicks into place.

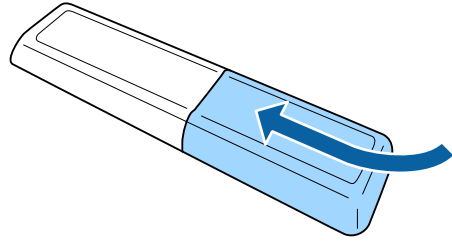

Warning: Dispose of used batteries according to local regulations. Do not expose batteries to heat or flame. Keep batteries out of the reach of children; they are choking hazards and are very dangerous if swallowed.

Parent topic: [Setting Up the Projector](#)

Using Basic Projector Features

Follow the instructions in these sections to use your projector's basic features.

[Turning On the Projector](#)

[Turning Off the Projector](#)

[Remote Control Operation](#)

[Pairing the Projector Remote Control](#)

[Selecting the Language for the Projector Menus](#)

[Projection Modes](#)

[Adjusting the Image Height](#)

[Image Shape](#)

[Focusing the Image Using the Focus Lever](#)

[Resizing the Image Using Zoom](#)

[Image Aspect Ratio](#)

[Color Mode](#)

[Turning On Automatic Luminance Adjustment](#)

[Adjusting Light Output \(Brightness\)](#)

[Saving Settings to Memory and Using Saved Settings](#)

[Controlling the Volume with the Volume Buttons](#)

Turning On the Projector

Turn on the projector before you turn on the video source you want to use.

Caution: Do not turn on the video source before connecting it to the projector; otherwise, you may damage the projector.

1. Connect the power cord to the projector's power inlet.

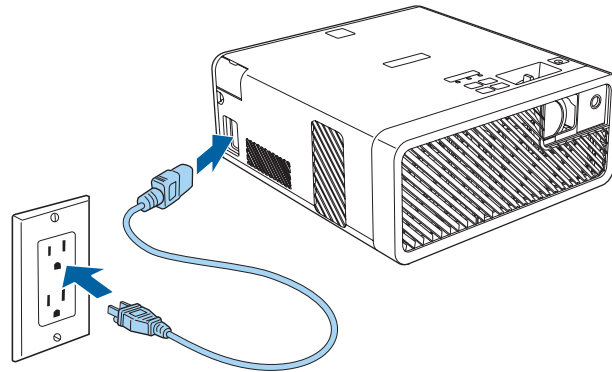

2. Plug the power cord into an electrical outlet.

Note: If the **Direct Power On** setting is turned on, the projector turns on as soon as you plug it in.

3. Press the  power button on the projector or the projector remote control to turn on the projector. The status light flashes blue as the projector warms up. After about 30 seconds, the status light stops flashing and turns blue.

Warning: Never look into the projector lens when the laser is on. This can damage your eyes and is especially dangerous for children and pets.

Caution: Make sure no objects are blocking the light from the projector lens. Objects blocking the lens for an extended time can melt and light that is reflected back into the lens can cause the projector to malfunction.

The Welcome Guide is displayed the first time you turn on the projector. To display the guide again, press the  menu button on the projector remote control and select **Settings > Display > Welcome Guide**.

Parent topic: [Using Basic Projector Features](#)

Related references

[Projector Feature Settings - Settings Menu](#)

Turning Off the Projector

Turn off the projector after use.

Note: Turn off this product when not in use to prolong the life of the projector. Laser life will vary depending upon mode selected, environmental conditions, and usage. Brightness decreases over time.

1. Press the  power button on the projector or the projector remote control.
The projector displays a shutdown confirmation screen.



2. Press the  power button again. (To leave it on, press any other button.)
The laser turns off and the status light turns off.

Caution: Do not turn the projector on immediately after turning it off. Turning the projector on and off frequently may shorten the life of the laser.

3. To transport or store the projector, make sure the  power light is blue (but not flashing) and the status light is off, then unplug the power cord.

Parent topic: [Using Basic Projector Features](#)

Remote Control Operation

The remote control lets you control the projector from almost anywhere in the room, up to 16.4 feet (5 m) away. You can point it at the front or back of the projector.

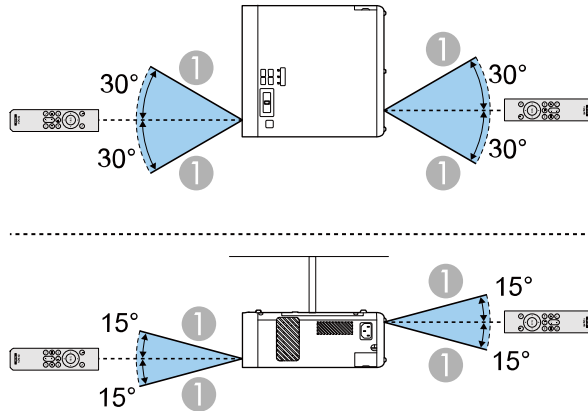

1 16.4 feet (5 m)

Note: Avoid using the remote control in conditions with bright fluorescent lights or in direct sunlight, or the projector may not respond to commands. If you will not use the remote control for a long time, remove the batteries.

Parent topic: [Using Basic Projector Features](#)

Pairing the Projector Remote Control

To use Android TV and video-on-demand features, you must pair the projector remote control with the projector.

Note: When you first turn on the projector, instructions for pairing the projector remote control are displayed on the screen.

1. Turn on the projector.
2. Press and hold the  home and **Enter** buttons on the projector remote control until the command light on the remote control starts blinking.

A message appears on the screen when the projector remote control is paired.

Parent topic: [Using Basic Projector Features](#)

Related tasks



[Connecting the Streaming Device](#)

Selecting the Language for the Projector Menus

If you want to view the projector's menus and messages in another language, you can change the Language setting.

1. Turn on the projector.
2. Press the  menu button on the projector remote control.
3. Press the arrow buttons to select the **Settings** menu and press **Enter**.



4. Select the **Language** setting and press **Enter**.
5. Select the language you want to use and press **Enter**.
6. Press the  menu button to exit the menu or the  return button to return to the previous screen.

Parent topic: [Using Basic Projector Features](#)

Projection Modes

Depending on how you positioned the projector, you may need to change the projection mode so your images project correctly.

- **Front** (default setting) lets you project from a table in front of the screen or onto the ceiling.
- **Front/Upside Down** flips the image over top-to-bottom to project upside-down from a ceiling or wall mount.
- **Rear** flips the image horizontally to project from behind a translucent screen.
- **Rear/Upside Down** flips the image over top-to-bottom and horizontally to project from the ceiling and behind a translucent screen.

[Changing the Projection Mode Using the Menus](#)

Parent topic: [Using Basic Projector Features](#)

Changing the Projection Mode Using the Menus



You can change the projection mode to flip the image over top-to-bottom and/or left-to-right using the projector menus.

Note: You can also press and hold the  A/V mute button on the projector remote control for about 6 seconds to flip the image upside-down.

1. Turn on the projector and display an image.
2. Press the  menu button on the projector remote control.

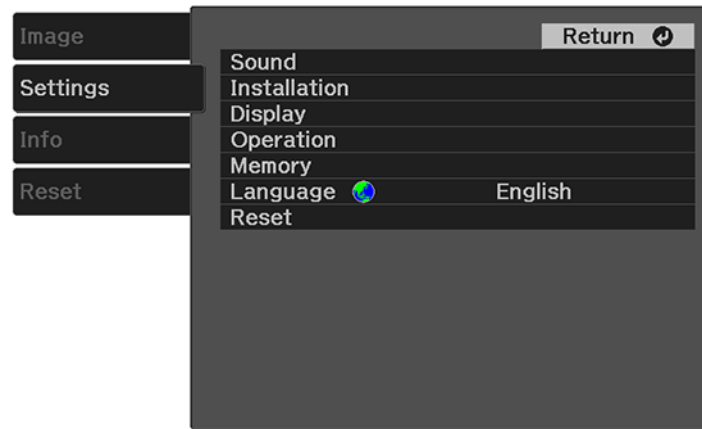
3. Press the arrow buttons to select the **Settings** menu and press **Enter**.



4. Select the **Installation** setting and press **Enter**.
5. Select the **Projection** setting and press **Enter**.
6. Select the projection mode you want to use and press **Enter**.
7. Press the  menu button to exit the menu or the  return button to return to the previous screen.

Parent topic: [Projection Modes](#)

Adjusting the Image Height

If you are projecting from a table or other flat surface and the image is too high or low, you can adjust the image height using the projector's adjustable foot.

1. Turn on the projector and display an image.

2. Press and hold the foot release lever to extend or retract the front adjustable foot.

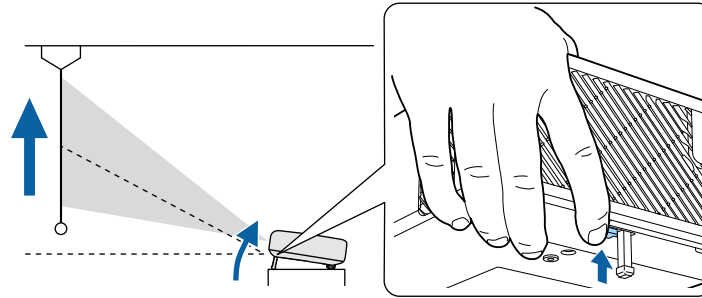

Note: You can adjust the position up to 11°.

3. Release the lever to lock the foot when the image is at the position you want.
If the projected image is unevenly rectangular, you need to adjust the image shape.

Parent topic: [Using Basic Projector Features](#)

Image Shape

You can project an evenly rectangular image by placing the projector directly in front of the center of the screen and keeping it level. If you place the projector at an angle to the screen, or tilted up or down, or off to the side, you may need to correct the image shape for the best display quality.

[Correcting Image Shape with H/V Keystone](#)

[Correcting Image Shape with Quick Corner](#)

Parent topic: [Using Basic Projector Features](#)

Correcting Image Shape with H/V Keystone

You can use the projector remote control or control panel buttons to correct the shape of an image that is unevenly rectangular on the sides.

Note: You can also adjust the keystone settings from the **Settings** menu.

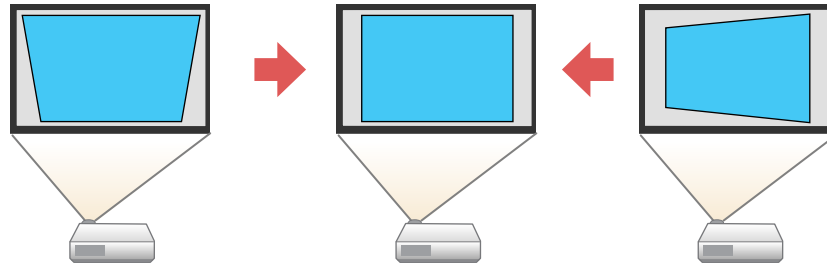

Note: You cannot combine **Keystone** correction with other image shape correction methods.

1. Turn on the projector and display an image.
2. Press the  keystone button on the projector remote control.
3. Use the arrow buttons on the projector remote control to select between vertical and horizontal keystone correction, and to adjust the image shape as necessary.

V-Keystone

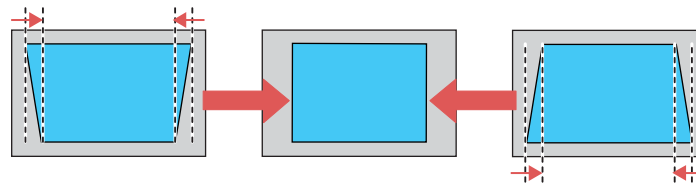

H-Keystone

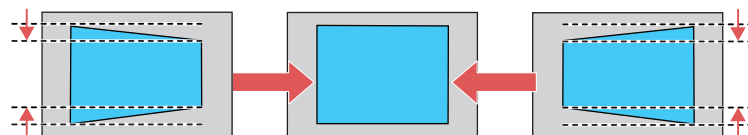

Note: You can also adjust the horizontal shape using the horizontal keystone buttons on the control panel.

4. Press the ↶ return button when you are finished.
After correction, your image is slightly smaller.

Parent topic: [Image Shape](#)

Related references

[Projector Feature Settings - Settings Menu](#)

Correcting Image Shape with Quick Corner

You can use the projector's Quick Corner setting to correct the shape and size of an image that is unevenly rectangular on all sides.

Note: To provide the best possible image quality, adjust the projector's position to correct the image shape. If this isn't possible, use the Quick Corner setting to correct the image shape.

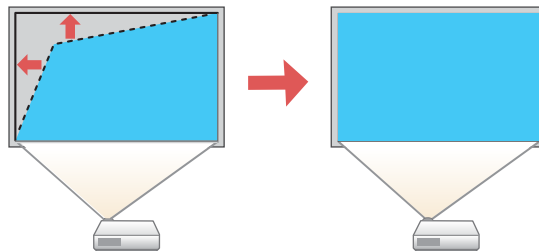

Note: You cannot combine Quick Corner correction with other image shape correction methods.

1. Turn on the projector and display an image.
2. Press the  menu button on the projector remote control.

3. Press the arrow buttons to select the **Settings** menu and press **Enter**.

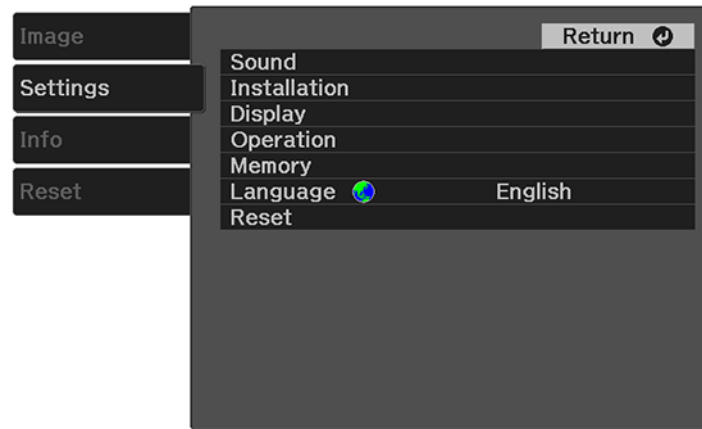

Note: You can also press the  keystone button on the projector remote control to display the Keystone adjustment screen.

4. Select the **Installation** setting and press **Enter**.
5. Select the **Keystone** setting and press **Enter**.
6. Select the **Quick Corner** setting and press **Enter** twice.

Note: When the Keystone option is set to **Quick Corner**, the horizontal keystone buttons on the control panel are disabled.

You see the Quick Corner adjustment screen:

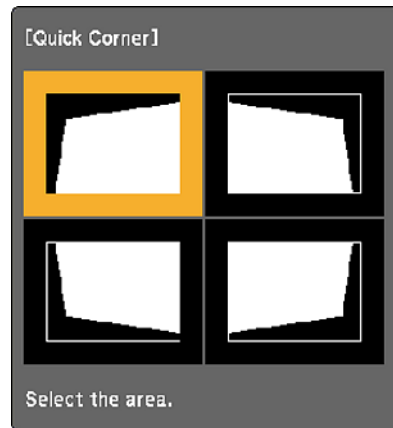

7. Use the arrow buttons on the projector remote control to select the corner of the image you want to adjust, then press **Enter**.
8. Press the arrow buttons to adjust the image shape as necessary, then press **Enter** to return to the area selection screen.

Note: To reset your adjustments, press and hold the ↩ return button for at least 2 seconds to display a reset screen, then select **Reset Quick Corner** and **Yes**.

9. Press the  menu button to exit the menu or the ↩ return button to return to the previous screen.

Parent topic: [Image Shape](#)

Focusing the Image Using the Focus Lever

You can adjust the sharpness of the projected image using the focus lever on the projector.

1. Turn on the projector and display an image.

2. Move the lever left or right to adjust the focus.

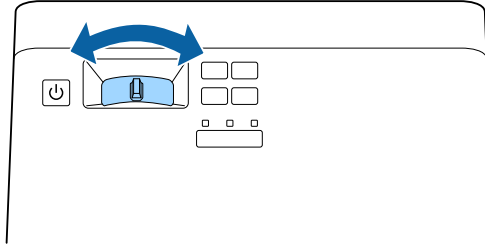
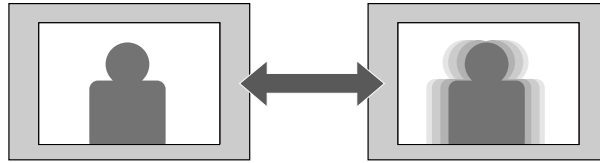

Parent topic: [Using Basic Projector Features](#)



Resizing the Image Using Zoom

You can resize the displayed image.

1. Turn on the projector and display an image.
2. Press the  menu button on the projector remote control.

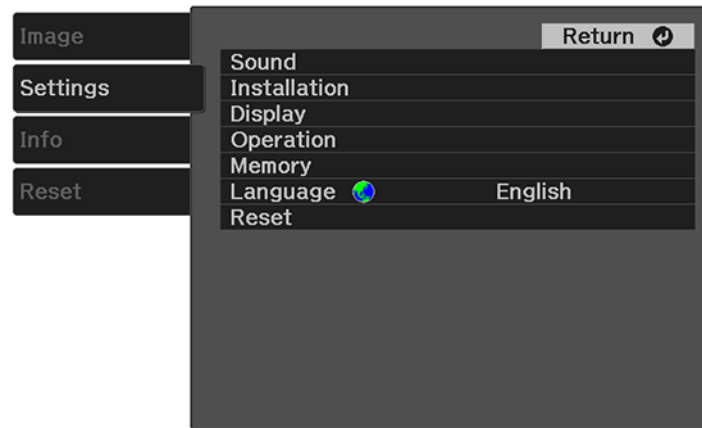
3. Press the arrow buttons to select the **Settings** menu and press **Enter**.



4. Select the **Installation** setting and press **Enter**.
5. Select the **Zoom** setting and press **Enter**.
6. Press the left or right arrow button to adjust the zoom setting.
7. Press the  menu button to exit the menu or the  return button to return to the previous screen.

Parent topic: [Using Basic Projector Features](#)

Image Aspect Ratio

The projector can display images in different width-to-height ratios called aspect ratios. Normally the input signal from your video source determines the image's aspect ratio. However, for certain images you can change the aspect ratio to fit your screen.

If you always want to use a particular aspect ratio for a certain video input source, you can select it using the projector's menus.

[Changing the Image Aspect Ratio](#)

[Available Image Aspect Ratios](#)



Parent topic: [Using Basic Projector Features](#)

Changing the Image Aspect Ratio

You can change the aspect ratio of the displayed image to resize it.

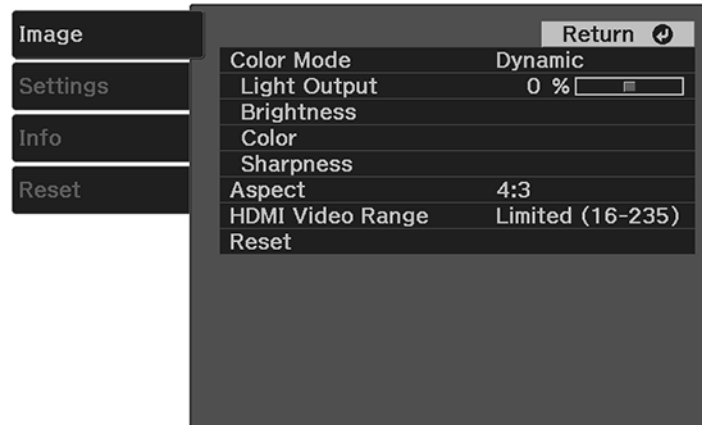
1. Turn on the projector and display an image.
2. Press the  menu button on the projector remote control.
3. Select the **Image** menu and press **Enter**.



4. Select the **Aspect** setting and press **Enter**.
5. Select the aspect ratio you want to use for your input signal and press **Enter**.
6. Press the  menu button to exit the menu or the  return button to return to the previous screen.

Parent topic: [Image Aspect Ratio](#)

Available Image Aspect Ratios

You can select the following image aspect ratios, depending on the input signal from your image source.

Aspect ratio setting	Description
Auto	Automatically sets the aspect ratio according to the input signal.
16:9	Converts the aspect ratio of the image to 16:9.
Full	Displays images using the full width of the projection area, but does not maintain the aspect ratio.
Zoom	Displays images using the full width of the projection area and maintains the aspect ratio of the image.

Parent topic: [Image Aspect Ratio](#)

Color Mode

The projector offers different Color Modes to provide optimum brightness, contrast, and color for a variety of viewing environments and image types. You can select a mode designed to match your image and environment, or experiment with the available modes.

[Changing the Color Mode](#)

[Available Color Modes](#)



Parent topic: [Using Basic Projector Features](#)

Changing the Color Mode

If you want to view the projector's menus and messages in another language, you can change the Language setting.

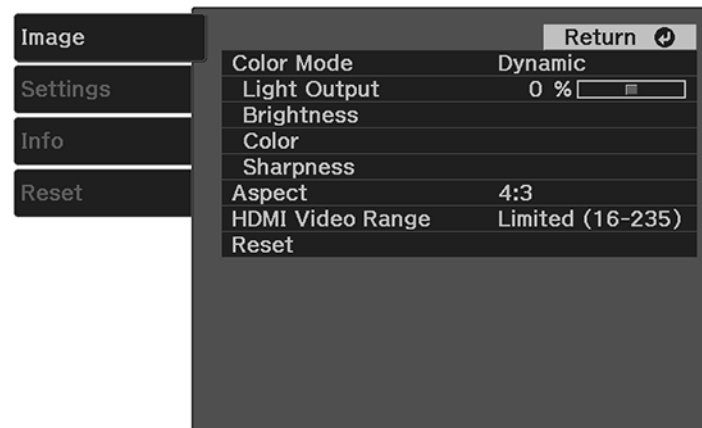
1. Turn on the projector and display an image.
2. Press the  menu button on the projector remote control.
3. Select the **Image** menu and press **Enter**.



4. Select the **Color Mode** setting and press **Enter**.
5. Select the color mode you want to use and press **Enter**.
6. Press the  menu button to exit the menu or the  return button to return to the previous screen.

Parent topic: [Color Mode](#)

Related references

[Image Quality Settings - Image Menu](#)

Available Color Modes

You can set the projector to use these Color Modes, depending on the input source you are using:

Color Mode	Description
Dynamic	Best for optimizing brightness
Bright Cinema	Best for projecting vivid images
Natural	Best for projecting the image as is (choose this mode when making color adjustments)
Cinema	Best for projecting movies

Parent topic: [Color Mode](#)



Turning On Automatic Luminance Adjustment

You can turn on the **Dynamic Contrast** setting to automatically optimize the image luminance. This improves the image contrast based on the brightness of the content you project.

1. Turn on the projector and display an image.
2. Press the  menu button on the projector remote control.

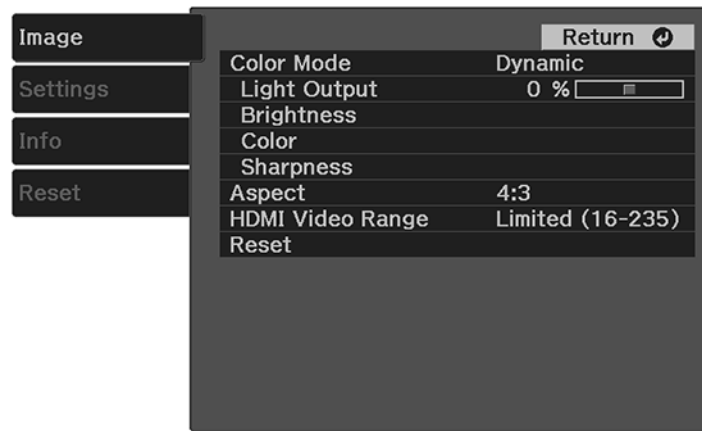
3. Select the **Image** menu and press **Enter**.



4. Select the **Brightness** setting and press **Enter**.
5. Select the **Dynamic Contrast** setting and press **Enter**.
6. Choose one of the following options and press **Enter**:
 - **Off**: turns off Dynamic Contrast
 - **Normal**: adjusts brightness at the standard speed
 - **High Speed**: adjusts brightness as soon as a scene changes
7. Press the  menu button to exit the menu or the  return button to return to the previous screen.

Parent topic: [Using Basic Projector Features](#)



Adjusting Light Output (Brightness)

You can adjust the brightness of the projector's light output.

1. Turn on the projector and display an image.
2. Press the  menu button on the projector remote control.

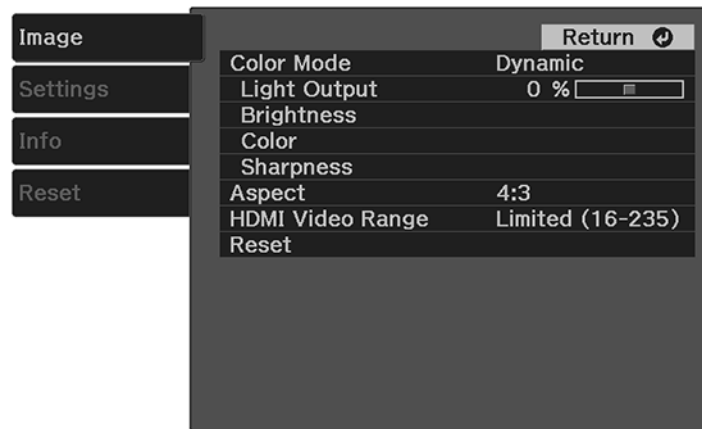
3. Select the **Image** menu and press **Enter**.



4. Select the **Light Output** setting and press **Enter**.
5. Press the left or right arrow buttons to adjust the brightness between 50% (**ECO**) and 100% (**Normal**).
6. Press the  menu button to exit the menu or the  return button to return to the previous screen.

Parent topic: [Using Basic Projector Features](#)

Saving Settings to Memory and Using Saved Settings



You can save the customized **Image** menu settings for your video input and then select the saved settings whenever you want to use them.

1. Turn on the projector and display an image.
2. Press the  menu button on the projector remote control.

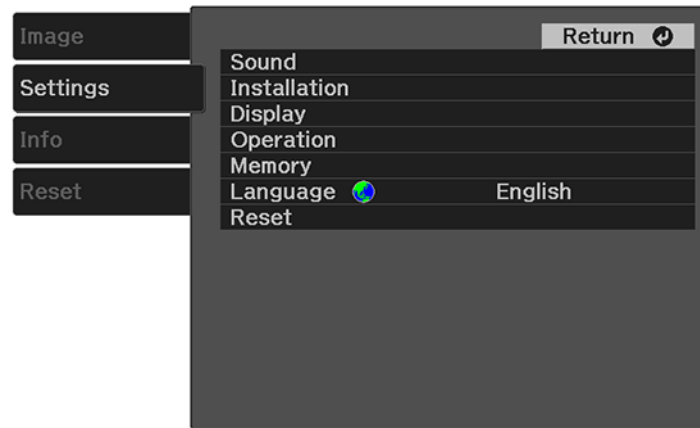
3. Press the arrow buttons to select the **Settings** menu and press **Enter**.



4. Select the **Memory** setting and press **Enter**.
5. Choose one of the following options and press **Enter**:
 - **Load Memory**: overwrites your current settings with saved settings
 - **Save Memory**: saves your current settings to memory (10 memories with different names are available)



Note: A memory name that has already been used is indicated by a blue mark. Saving over a previously saved memory overwrites the settings with your current settings.
 - **Erase Memory**: erases the selected memory settings
 - **Rename Memory**: renames a saved memory
Note: To delete all saved memories, select the **Reset Memory** setting in the **Reset** menu.
6. Press the  menu button to exit the menu or the  return button to return to the previous screen.

Parent topic: [Using Basic Projector Features](#)

Controlling the Volume with the Volume Buttons

You can use the volume buttons to adjust the volume of the projector's internal speaker, any external speakers or headphones connected to the projector, or any Bluetooth audio device paired to the projector.

Note: You must adjust the volume separately for each connected input source.

1. Turn on the projector and start a video that includes audio.
2. To raise or lower the volume, press the  volume up or  volume down button on the control panel or the projector remote control.

A volume gauge appears on the screen.

Parent topic: [Using Basic Projector Features](#)

Adjusting Projector Features

Follow the instructions in these sections to use your projector's feature adjustments.

[Operating Connected Devices Using the HDMI Link Features](#)

[Shutting Off the Picture and Sound Temporarily](#)

[Projector Security Features](#)

Operating Connected Devices Using the HDMI Link Features

You can use the projector remote control to control certain features of devices connected to the projector's HDMI port.

Note: The connected device and HDMI cable must meet the HDMI CEC standard. The device must also be configured; see the documentation that came with the device. All devices or functions may not operate properly.

1. Press the  menu button on the projector remote control.
2. Press the arrow buttons to select the **Settings** menu and press **Enter**.

You see this screen:

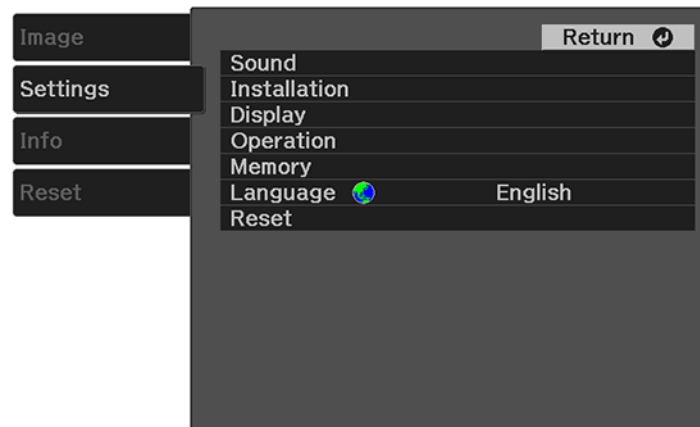

3. Select the **Operation** setting and press **Enter**.
4. Select the **HDMI Link** setting and press **Enter**.

You see this screen:

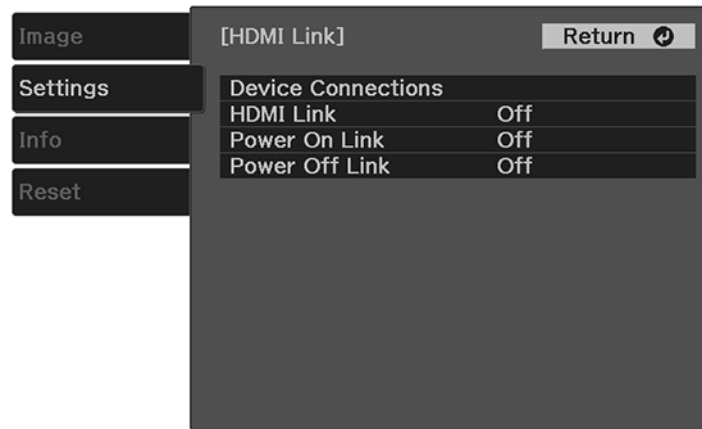

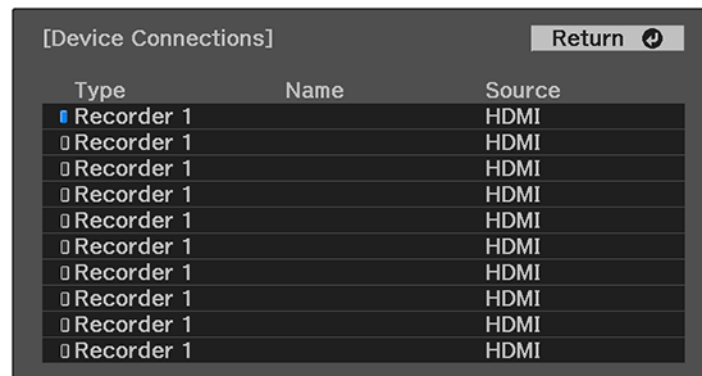

5. Select the **HDMI Link** setting and press **Enter**. Then select **On** and press the ↩ return button.
6. Select the **Device Connections** setting and press **Enter**.

You see this screen:



Note: Linked devices are indicated by a blue mark. You cannot select grayed-out devices.



7. Select the device you want to control and project images from and press **Enter**.

8. Select the following HDMI Link options as necessary and press **Enter**:
 - **Power On Link**: select what happens when you turn on the projector or linked device. Select **PJ - > Device** or **Bidirectional** to turn the linked device on when the projector is turned on, or select **Device -> PJ** or **Bidirectional** to turn the projector on when the linked device is turned on.
 - **Power Off Link**: select whether linked devices are turned off when the projector is turned off.
9. Press the  menu button to exit the menu or the  return button to return to the previous screen.

Parent topic: [Adjusting Projector Features](#)

Shutting Off the Picture and Sound Temporarily

You can temporarily turn off the projector's picture and sound. Any sound or video action continues to run, however, so you cannot resume projection at the point that you stopped it.

1. Press the  A/V mute button on the projector remote control to temporarily stop projection and mute any sound.
2. To turn the picture and sound back on, press the  A/V mute button again.

Parent topic: [Adjusting Projector Features](#)

Projector Security Features

You can secure your projector to deter theft or prevent unintended use by setting up the following security features:

- Button lock security to block operation of the projector using the buttons on the control panel.
- Security cabling to physically cable the projector in place.

[Locking the Projector's Buttons](#)

[Installing a Security Cable](#)

Parent topic: [Adjusting Projector Features](#)

Locking the Projector's Buttons

You can lock the buttons on the projector's control panel to prevent anyone from using the projector. You can lock all the buttons or all the buttons except the  power button.

Note: You can still operate the projector using the projector remote control.

1. Press the  menu button on the projector remote control.

2. Press the arrow buttons to select the **Settings** menu and press **Enter**.

You see this screen:

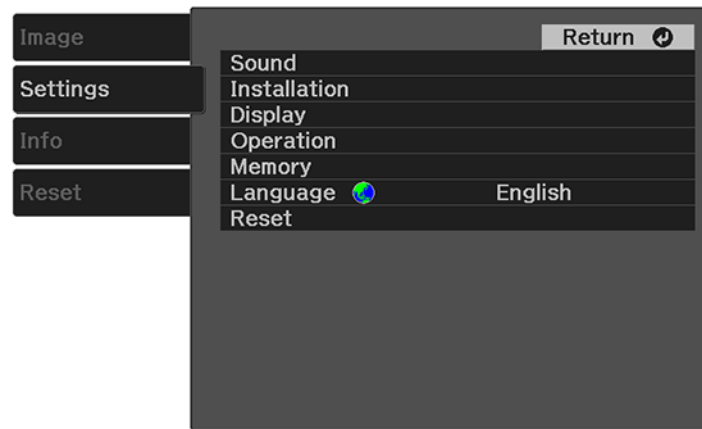

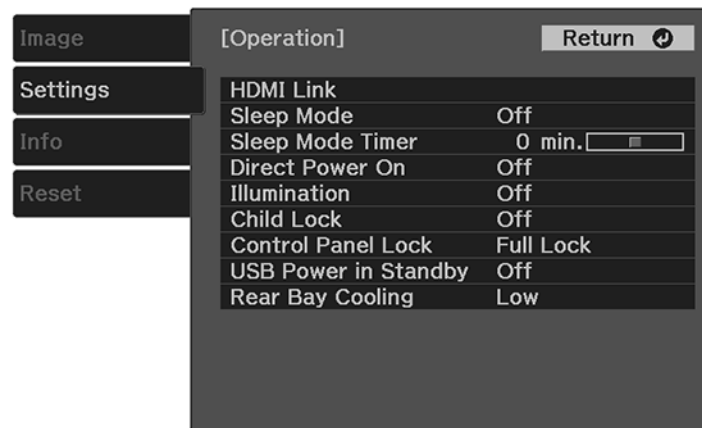

3. Select the **Operation** setting and press **Enter**.

You see this screen:



4. Do one of the following:
 - To lock the projector's power button, select **Child Lock** and select **On**. You must turn the projector off and then on again to enable the setting.



Note: To turn the projector on when this setting is enabled, you must press and hold the power button for about 3 seconds.
 - To lock all the projector's buttons, select **Control Panel Lock > Full Lock**. Select **Yes** at the confirmation screen.
 - To lock all the projector's buttons except the power button, select **Control Panel Lock > Partial Lock**. Select **Yes** at the confirmation screen.
5. Press the  menu button to exit the menu or the  return button to return to the previous screen.

[Unlocking the Projector's Buttons](#)

Parent topic: [Projector Security Features](#)

Unlocking the Projector's Buttons

If the projector's buttons have been locked, do one of the following:

- To disable the child lock setting, press the  menu button on the projector remote control and select **Settings > Operation > Child Lock > Off**. You must turn the projector off and then on again to disable the setting.
- To release the control panel lock, press and hold the  volume down button on the control panel for about 7 seconds. A message appears and the lock is released.

Parent topic: [Locking the Projector's Buttons](#)

Installing a Security Cable

You can use the security slot on the side of the projector to attach a Kensington lock. See your local computer or electronics dealer for purchase information.

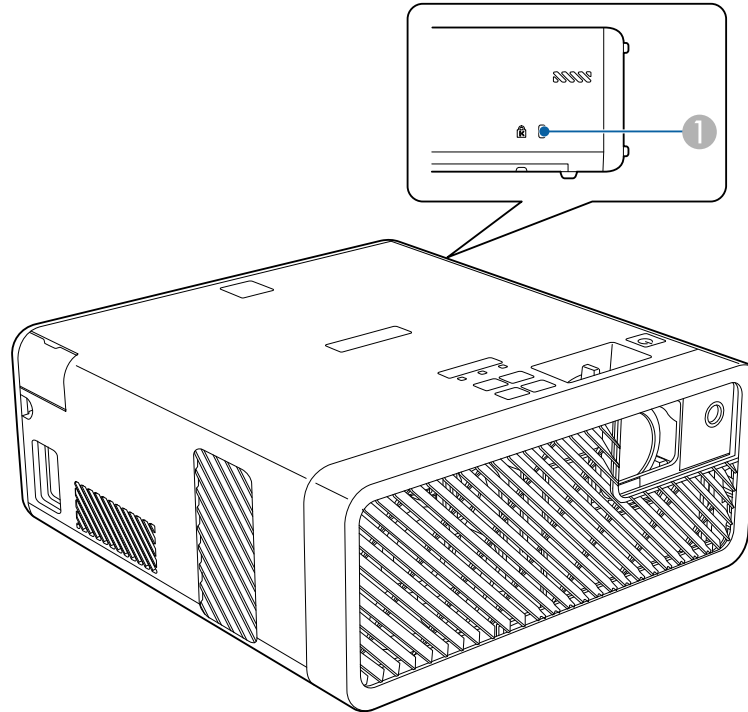

1 Security slot

Parent topic: [Projector Security Features](#)

Adjusting the Menu Settings

Follow the instructions in these sections to access the projector menu system and change projector settings.

[Using the Projector's Menus](#)

[Image Quality Settings - Image Menu](#)

[Projector Feature Settings - Settings Menu](#)

[Projector Information Display - Info Menu](#)

[Projector Reset Options - Reset Menu](#)

Using the Projector's Menus

You can use the projector's menus to adjust the settings that control how your projector works. The projector displays the menus on the screen.

1. Press the  menu button on the projector remote control.

You see a screen like this:

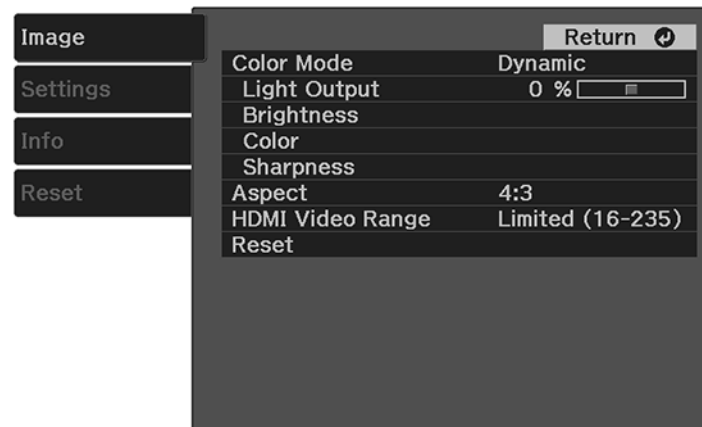

2. Press the up or down arrow button to move through the menus listed on the left. The settings for each menu are displayed on the right.

Note: The available settings depend on the current input source.

3. To change settings in the displayed menu, press **Enter**.
4. Press the up or down arrow button to move through the settings.
5. Change the settings using the buttons listed on the bottom of the menu screens.
6. To return all the menu settings to their default values, select **Reset**.
7. When you finish changing settings on a menu, press the ↵ return button.
8. Press the ≡ menu button to exit the menu or the ↵ return button to return to the previous screen.

Parent topic: [Adjusting the Menu Settings](#)

Image Quality Settings - Image Menu

Settings on the Image menu let you adjust the quality of your image for the input source you are currently using. The available settings depend on the currently selected input source.

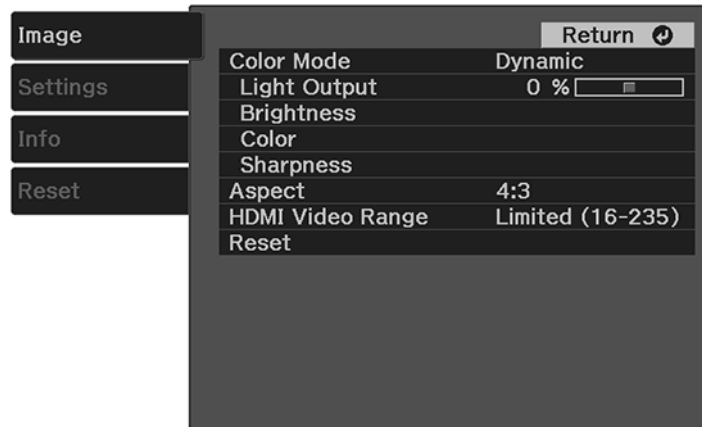

Setting	Options	Description
Color Mode	See the list of available Color Modes	Adjusts the vividness of image colors for various image types and environments
Light Output	50% (ECO) to 100% (Normal)	Adjusts laser brightness

Setting	Options	Description
Brightness	Brightness	Lightens or darkens the overall image
	Contrast	Adjusts the difference between light and dark areas in the image
	Gamma	Adjusts the coloring in the image
	Dynamic Contrast	Adjusts the projected luminance based on the image brightness when Dynamic or Cinema is selected as the Color Mode . Select Off , Normal , or High Speed .
	EPSON Super White	Reduces overexposure of white in the image
Color	Color Saturation	Adjusts the color intensity of the image
	Tint	Adjusts the balance of green to magenta tones in the image
	White Balance	Color Temp.: sets the color temperature according to the selected color mode; lower values tint the image red, and higher values tint the image blue Customized: adjusts the individual RGB components of the offset and gain
	RGBCMY	Adjusts the hue, saturation, and brightness for each individual color

Setting	Options	Description
Sharpness	Sharpness	Adjusts the sharpness or softness of image details
	Noise Reduction	Reduces flickering in analog images
	MPEG Noise Reduction	Reduces noise or artifacts in MPEG videos
Aspect	See the list of available aspect ratios	Sets the aspect ratio (width-to-height ratio) for the input source
HDMI Video Range	Auto Limited (16–235) Full (0–255)	Sets the video range to match the setting of the device connected to the HDMI port
Reset	—	Resets all Image menu settings to their defaults

Note: The **Brightness** setting does not affect laser brightness. To change the laser brightness, adjust the **Light Output** setting.

Parent topic: [Adjusting the Menu Settings](#)

Related references

[Available Color Modes](#)

[Available Image Aspect Ratios](#)

Related tasks

[Changing the Color Mode](#)

[Changing the Image Aspect Ratio](#)

Projector Feature Settings - Settings Menu

Options on the Settings menu let you customize various projector features.

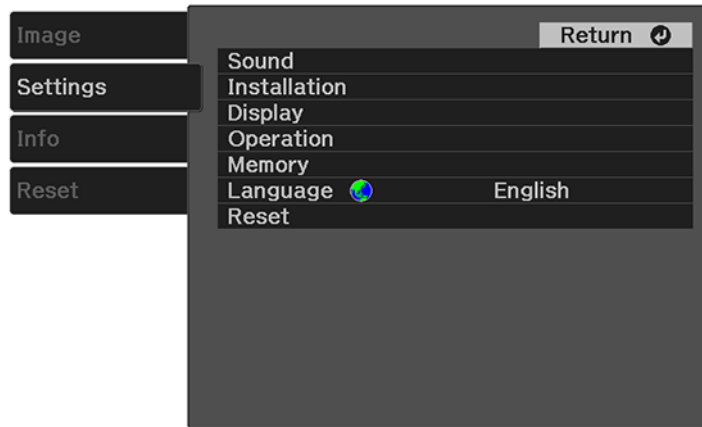



Setting	Options	Description
Sound	Volume	Adjusts the volume of the projector's speaker or the volume of a Bluetooth audio device that is paired to the projector
	Sound Mode	<p>Sets a sound mode for the type of playback content (music, movie, etc.)</p> <p>Standard: best for normal sound quality</p> <p>Vocal: best for voices and dialogue</p> <p>Music: best for music</p> <p>Movie: best for video or movie audio</p> <p>This setting is disabled for Bluetooth audio devices.</p>
	Bluetooth	<p>Selects Bluetooth features</p> <p>Search Bluetooth Device: searches for available Bluetooth devices</p> <p>Bluetooth Audio: turns Bluetooth audio on or off</p> <p>Connected Device: displays information for the Bluetooth audio device that is paired to the projector</p>

Setting	Options	Description
Installation	Keystone	Adjusts image shape to rectangular (horizontally and vertically) H/V Keystone: lets you manually correct horizontal and vertical sides Quick Corner: select to correct image shape and alignment using an on-screen display
	Zoom	Adjusts the image size
	Projection	Selects the way the projector faces the screen
	OSD Rotation	Rotates the menu display 90°
	High Altitude Mode	Regulates the projector's operating temperature at altitudes above 4921 feet (1500 m)

Setting	Options	Description
Display	Welcome Guide	Shows the product features and usage tips
	Messages	Select On to display messages for color mode name, aspect ratio, or high temperature warning
	Startup Screen	Select On to display Epson logo at startup
	Standby Confirmation	Select Off to shut down the projector without displaying the shutdown confirmation prompt when you press the power button on the control panel or on the projector remote control
	Picture Demo Mode	Select On to display pre-installed images when there is no input signal When enabled, the projector does not enter Sleep Mode.
Operation	Various options (see table below)	Various options (see table below)
Memory	Various options	Sets up or saves customized settings to memory
Language	Various languages	Sets the language for the projector menus and messages
Reset	—	Resets adjustments to their default settings except the following settings: Zoom, Projection, High Altitude Mode, Power On Link, Power Off Link, USB Power in Standby, Rear Bay Cooling, Memory, and Language

Operation settings

Options	Description
HDMI Link	<p>Adjusts HDMI Link options that allow the projector remote control to control HDMI-connected devices that support the CEC standard</p> <p>Device Connections: lists the device connected to the HDMI port</p> <p>HDMI Link: turns HDMI Link on or off</p> <p>Power On Link: controls what happens when you turn on the projector or connected device</p> <p>Power Off Link: controls if the connected device is turned off or not when you turn off the projector</p>
Sleep Mode	Select On to place the projector in standby mode after a certain interval of inactivity
Sleep Mode Timer	Sets the sleep mode interval between 1 and 30 minutes
Direct Power On	Turns the projector on when it is plugged in instead of using the  power button
Illumination	Turns off the indicators on the projector
Child Lock	Locks the  power button on the control panel
Control Panel Lock	<p>Controls projector button locking to secure the projector</p> <p>Full Lock: locks all buttons on the control panel</p> <p>Partial Lock: locks all buttons on the control panel except the  power button</p>
USB Power in Standby Mode	<p>Sends power to the connected device even if the projector is in standby mode (when the power is off). If the internal temperature of the projector gets too high, the power supply may stop automatically.</p> <p>This feature is not available in all countries.</p>
Rear Bay Cooling	Sets the cooling fan speed for the connected device

Parent topic: [Adjusting the Menu Settings](#)

Related tasks

[Saving Settings to Memory and Using Saved Settings](#)

Projector Information Display - Info Menu

You can display information about the projector and input sources by viewing the Info menu. However, you cannot change any settings in the menu.



Select **Projector Info** to display the settings described below. Select **Light Source Info** to display the projector's light source information. Select **Version** to display the projector's firmware version.

Information item	Description
Operation Hours	Displays the number of hours (H) the projector has been used since it was turned on
Source	Displays the name of the port to which the current input source is connected
Input Signal	Displays the input signal setting of the current input source
Resolution	Displays the resolution of the current input source
Refresh Rate	Displays the refresh rate of the current input source
Sync Info	Displays information that may be needed by a service technician
Status	Displays information about projector problems that may be needed by a service technician
Product Name	Displays the projector's model name

Information item	Description
Serial Number	Displays the projector's serial number

Parent topic: [Adjusting the Menu Settings](#)

Projector Reset Options - Reset Menu

You can reset most of the projector settings to their default values using the Reset menu.

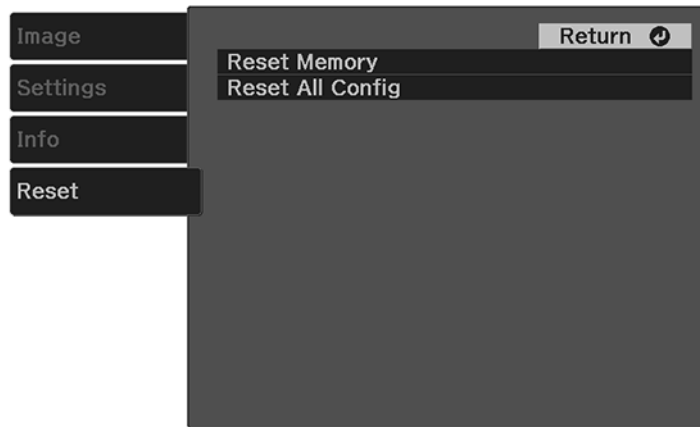

Setting	Description
Reset Memory	Deletes all saved memories
Reset All Config	Resets most of the projector settings to their defaults, except the Zoom , Memory , and Language settings

Parent topic: [Adjusting the Menu Settings](#)

Maintaining and Transporting the Projector

Follow the instructions in these sections to maintain your projector and transport it from place to place.

[Projector Maintenance](#)

[Air Filter and Vent Maintenance](#)

[Replacing the Remote Control Batteries](#)

[Transporting the Projector](#)

Projector Maintenance

Your projector needs little maintenance to keep working at its best.

You may need to clean the projection window periodically, and clean the air filter and air vents to prevent the projector from overheating due to blocked ventilation.

The only parts you should replace are the air filter and remote control batteries. If any other part needs replacing, contact Epson or an authorized Epson servicer.

This projector uses a sealed laser light source which does not need servicing and cannot be replaced.

Warning: Before cleaning any part of the projector, turn it off and unplug the power cord. Never open any cover on the projector, except as specifically explained in this manual. Dangerous electrical voltages in the projector can injure you severely.

Warning: Do not try to service this product yourself, except as specifically explained in this manual. Refer all other servicing to qualified servicers.

[Cleaning the Projection Window](#)

[Cleaning the Projector Case](#)

Parent topic: [Maintaining and Transporting the Projector](#)

Cleaning the Projection Window

Clean the projection window periodically, or whenever you notice dust or smudges on the surface.

- To remove dust or smudges, gently wipe the projection window with lens-cleaning paper.

- To remove stubborn smudges, moisten a soft, lint-free cloth with lens cleaner and gently wipe the projection window.

Warning: Do not use a lens cleaner that contains flammable gas. The high heat generated by the projector may cause a fire.

Caution: Do not use canned air, or the gases may leave a flammable residue. Do not use glass cleaner or any harsh materials to clean the projection window and do not subject the projection window to any impacts; you may damage it.

Parent topic: [Projector Maintenance](#)

Cleaning the Projector Case

Before cleaning the projector case, turn off the projector and unplug the power cord.

- To remove dust or dirt, use a soft, dry, lint-free cloth.
- To remove stubborn dirt, use a soft cloth moistened with water and mild soap. Do not spray liquid directly on the projector.

Caution: Do not use wax, alcohol, benzene, paint thinner, or other chemicals to clean the projector case. These can damage the case. Do not use canned air, or the gases may leave a flammable residue.

Parent topic: [Projector Maintenance](#)

Related tasks

[Turning Off the Projector](#)

Air Filter and Vent Maintenance

Regular filter maintenance is important to maintaining your projector. Your Epson projector is designed with an easily accessible, user-replaceable filter to protect your projector and make regular maintenance simple. Filter maintenance intervals will depend on the environment.

If regular maintenance is not performed, your Epson projector will notify you when the temperature inside the projector has reached a high level. Do not wait until this warning appears to maintain your projector filter as prolonged exposure to high temperatures may reduce the life of your projector or laser.

Damage due to the failure to properly maintain the projector or its filter may not be covered by the projector's Limited Warranty.

[Cleaning the Air Filter and Vents](#)

[Replacing the Air Filter](#)

Parent topic: [Maintaining and Transporting the Projector](#)

Cleaning the Air Filter and Vents

Clean the projector's air filter and vents if they get dusty, or if you see a message telling you to clean them.

1. Turn off the projector and unplug the power cord.
2. Gently remove the dust using a small vacuum designed for computers or a very soft brush (such as a paintbrush).

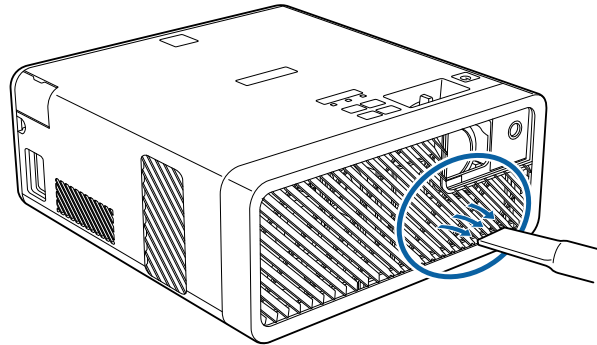

Note: You can remove the air filter to clean both sides. Do not use water or any other solvent to clean the air filter.

Caution: Do not use canned air. The gases may leave a flammable residue or push dust and debris into the projector's optics or other sensitive areas.

Parent topic: [Air Filter and Vent Maintenance](#)

Related tasks

[Turning Off the Projector](#)

[Replacing the Air Filter](#)

Replacing the Air Filter

You need to replace the air filter in the following situations:

- After cleaning the air filter, you see a message telling you to clean or replace it
- The air filter is torn or damaged

You can replace the air filter while the projector is mounted to the ceiling or placed upside-down on a table.

1. Turn off the projector and unplug the power cord.
2. Place the projector upside-down on a table.
3. Remove the air filter cover.

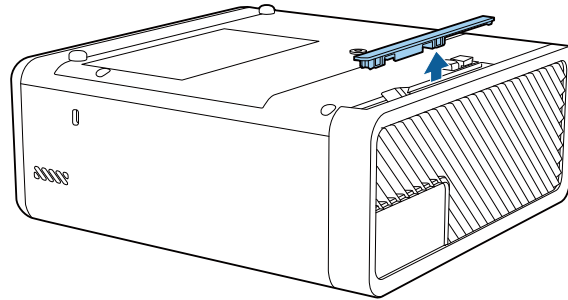

4. Pull the air filter out of the projector.

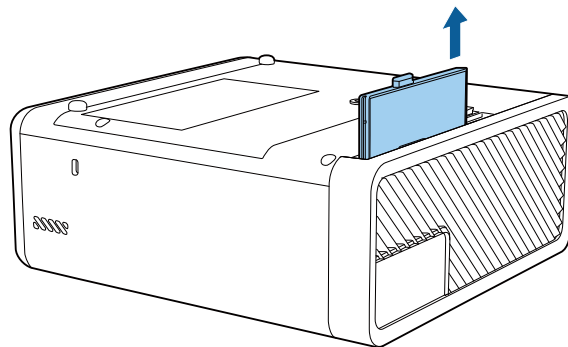

Note: Air filters contain ABS resin and polyurethane foam. Dispose of used air filters according to local regulations.

5. Place the new air filter in the projector as shown and push gently until it clicks into place.

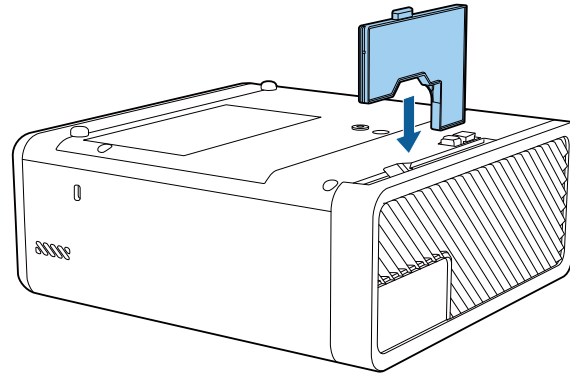

6. Replace the air filter cover.

Parent topic: [Air Filter and Vent Maintenance](#)

Related references

[Optional Equipment and Replacement Parts](#)

Replacing the Remote Control Batteries

The remote control uses two AAA manganese or alkaline batteries. Replace the batteries as soon as they run out.

Caution: Use only the type of batteries specified in this manual. Do not install batteries of different types, or mix new and old batteries.

1. Remove the battery cover as shown.

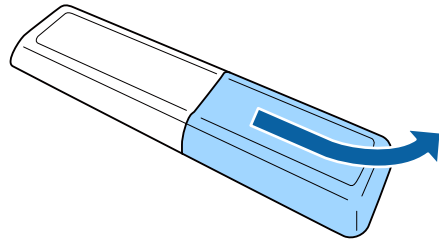

2. Remove the old batteries.

Warning: If the battery fluid has leaked, wipe it away with a soft cloth and avoid getting the fluid on your hands. If it gets on your hands, wash them immediately to avoid injury.

3. Insert the batteries with the + and – ends facing as shown.

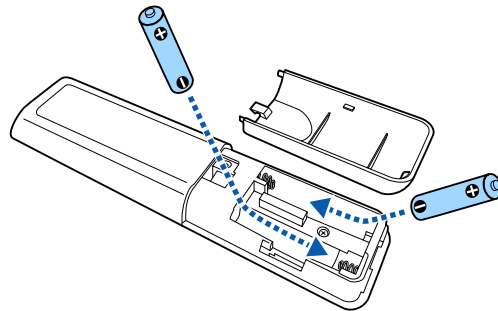

Warning: Make sure the batteries are inserted in the correct positions. If the batteries are not inserted correctly, they could explode or leak, causing a fire, injury, or damage to the product.

4. Replace the battery cover and press it down until it clicks into place.

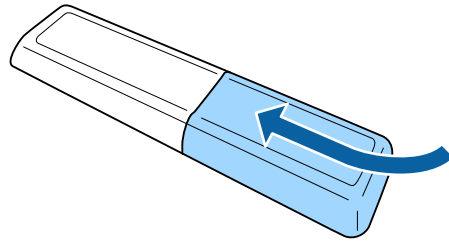

Warning: Dispose of used batteries according to local regulations. Do not expose batteries to heat or flame. Keep batteries out of the reach of children; they are choking hazards and are very dangerous if swallowed.

Parent topic: [Maintaining and Transporting the Projector](#)

Transporting the Projector

The projector contains precision parts, some of which are glass. Follow the guidelines here to transport, ship, or store the projector safely.

1. Turn off the projector.
2. Make sure the  power light is blue (but not flashing) and the status light is off, then unplug the power cord.
3. Do one of the following:
 - When transporting the projector a long distance or as checked luggage, pack it in a firm box with cushioning around it and mark the box "Fragile."
 - When shipping the projector for repairs, place it in its original packing materials, if possible, or use equivalent materials with cushioning around the projector. Mark the box "Fragile."

Note: Epson shall not be liable for any damages incurred during transportation.

Parent topic: [Maintaining and Transporting the Projector](#)

Related tasks

[Turning Off the Projector](#)

Solving Problems

Check the solutions in these sections if you have any problems using the projector.

[Projection Problem Tips](#)

[Projector Light Status](#)

[Solving Image or Sound Problems](#)

[Solving Projector or Remote Control Operation Problems](#)

[Solutions to HDMI Link Problems](#)

[Where to Get Help \(U.S. and Canada\)](#)

[Where to Get Help \(Latin America\)](#)

Projection Problem Tips

If the projector is not working properly, try turning it off and unplugging it. Then plug it back in and turn it on.

If this does not solve the problem, check the following:

- The lights on the projector may indicate what the problem is.
- The solutions in this manual can help you solve many problems.

If none of these solutions help, you can contact Epson for technical support.

Parent topic: [Solving Problems](#)

Related references

[Projector Light Status](#)

Related tasks

[Turning On the Projector](#)

[Turning Off the Projector](#)

Projector Light Status

The lights on the projector indicate the projector status and let you know when a problem occurs. Check the status and color of the lights and look for a solution in the tables here.

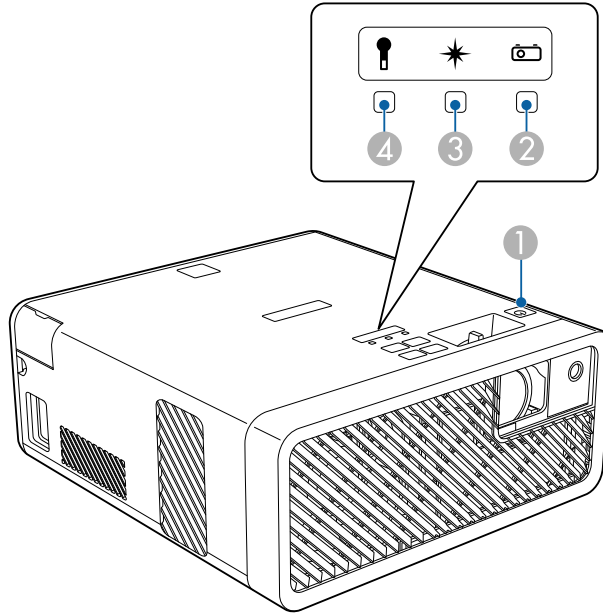

- 1 Power light
- 2 Status light
- 3 Laser light
- 4 Temp (temperature) light

Note: If no lights turn on when the projector is on, make sure the **Illumination** setting is turned on in the **Settings** menu.

Power light	Status light	Laser light	Temp light	Status and solution
Blue	Blue	Off	Off	Normal operation
Blue	Off	Off	Off	Standby or sleep mode

Power light	Status light	Laser light	Temp light	Status and solution
Blue	Flashing blue	Off	Off	Warming up. Wait for about 30 seconds for an image to appear. All buttons are disabled.
				Cooling down or shutting down. All buttons are disabled.
Flashing blue	Off	Off	Off	The projector is preparing to enter USB Power in Standby mode
Off	Flashing blue	Flashing orange	Off	Internal projector error. Turn the projector off, unplug it, and contact Epson for help.
Off	Flashing blue	Off	Flashing orange	A fan or sensor has a problem. Turn the projector off, unplug it, and contact Epson for help.
Off	Flashing blue	Off	Orange	<p>Projector has overheated and turned off. Leave it turned off to cool down. After about five minutes, do the following:</p> <ul style="list-style-type: none"> • Make sure that the vents are not clogged with dust or obstructed by nearby objects. • Clean or replace the air filter. • If operating the projector at high altitude, turn on High Altitude Mode. • If the problem persists, unplug the projector and contact Epson for help.

Power light	Status light	Laser light	Temp light	Status and solution
Off	Flashing blue	Orange	Off	<p>Laser has a problem.</p> <ul style="list-style-type: none"> • Make sure that the vents are not clogged with dust or obstructed by nearby objects. • If the problem persists, unplug the projector and contact Epson for help.
Blue	Varies	Varies	Flashing orange	<p>Projector is too hot.</p> <ul style="list-style-type: none"> • Make sure that the vents and air filter are not clogged with dust or obstructed by nearby objects. • Clean or replace the air filter. • Make sure the environmental temperature is not too hot. • If the problem persists, unplug the projector and contact Epson for help.
Flashing blue	Varies	Flashing orange	Varies	<p>Laser warning. Turn the projector off, unplug it, and contact Epson for help.</p>

Note: If the lights display a pattern not listed in the tables above, turn the projector off, unplug it, and contact Epson for help.

Parent topic: [Solving Problems](#)

Related references

[Where to Get Help \(U.S. and Canada\)](#)

[Where to Get Help \(Latin America\)](#)

[Projector Feature Settings - Settings Menu](#)

[Projector Parts - Control Panel](#)

Related tasks

[Cleaning the Air Filter and Vents](#)

[Replacing the Air Filter](#)

Solving Image or Sound Problems

Check the solutions in these sections if you have any problems with projected images or sound.

[Solutions When No Image Appears](#)

[Solutions When "No Signal" Message Appears](#)

[Solutions When the Image is Not Rectangular](#)

[Solutions When Only a Partial Image Appears](#)

[Solutions When the Image Contains Noise or Static](#)

[Solutions When the Image is Fuzzy or Blurry](#)

[Solutions When the Image Brightness or Colors are Incorrect](#)

[Solutions to Sound Problems](#)

[Solutions to Bluetooth Audio Problems](#)

Parent topic: [Solving Problems](#)

Solutions When No Image Appears

If no image appears, try the following solutions:

- Press the  A/V mute button on the projector remote control to see if the image was temporarily turned off.
- Check the status lights to confirm the projector is operating normally.
- Make sure all necessary cables are securely connected and the power is on for the projector and connected video sources.
- Try using a shorter HDMI cable.
- Press the projector's power button to wake it from standby or sleep mode. Also see if your connected computer is in sleep mode or displaying a blank screen saver.
- If you are projecting from a streaming device, make sure it is powered by the USB power cable inside the projector. Turn on the connected streaming device or video source, and press the play button to start a video, if necessary.
- Make sure the connected device meets the HDMI CEC standard. See the documentation supplied with the device for more information. If necessary, set the CEC function for the connected device again and restart the device. Turn off the projector and the connected streaming device or video source, and then turn them back on.

- Make sure the connected device does not require MHL; the projector's HDMI port does not support MHL.
- Turn off the projector and the connected streaming device or video source, and then turn them back on.
- Press the  menu button on the projector remote control. If the projector menu displays, there may be a problem with the connected video source, cable connection, or port.
- If you are projecting from a laptop computer, make sure it is set up to display on an external monitor.
- Make sure the computer's display resolution does not exceed the projector's resolution and frequency limits. If necessary, select a different display resolution for your computer. (See your computer manual for details.)
- If the other solutions do not solve the problem, reset all of the projector settings using the options on the **Reset** menu.

Parent topic: [Solving Image or Sound Problems](#)

Related references

[Projector Light Status](#)

[Projector Reset Options - Reset Menu](#)

Related tasks

[Connecting the Streaming Device](#)

[Connecting to an HDMI Video Source](#)

[Turning On the Projector](#)

[Turning Off the Projector](#)

Solutions When "No Signal" Message Appears

If the "No Signal" message appears, try the following solutions:

- Turn on the connected computer or video source, and press its play button to begin your presentation, if necessary.
- Check the connection from the projector to your video sources.
- If you are projecting from a laptop computer, make sure it is set up to display on an external monitor.
- If necessary, turn the projector and the connected computer or video source off and then on again.
- Try a different video cable.
- If the other solutions do not solve the problem, reset all of the projector settings using the options on the **Reset** menu.

[Displaying From a PC Laptop](#)

[Displaying From a Mac Laptop](#)

Parent topic: [Solving Image or Sound Problems](#)

Related references

[Projector Reset Options - Reset Menu](#)

Related tasks

[Connecting to an HDMI Video Source](#)

Displaying From a PC Laptop

If you see the "No Signal" message when you display from a PC laptop, you need to set up the laptop to display on an external monitor.

1. Hold down the laptop's **Fn** key and press the key labeled with a monitor icon or **CRT/LCD**. (See your laptop manual for details.) Wait a few seconds for an image to appear. To display on both the laptop's monitor and the projector, try pressing the same keys again.

Note: On Windows 7 or later, hold down the Windows key and press **P** at the same time, then click **Duplicate**.

2. If the same image is not displayed by the laptop and projector, check the Windows **Display** utility to make sure the external monitor port is enabled and extended desktop mode is disabled. (See your computer or Windows manual for instructions.)
3. If necessary, check your video card settings and set the multiple display option to **Clone**, **Mirror**, or **Duplicate**.

Parent topic: [Solutions When "No Signal" Message Appears](#)

Displaying From a Mac Laptop

If you see the "No Signal" message when you display from a Mac laptop, you need to set up the laptop for mirrored display. (See your laptop manual for details.)

1. Open the **System Preferences** utility and select **Displays**, **Display**, or **Color LCD**.
2. Click the **Arrange** or **Arrangement** tab.
3. Select the **Mirror Displays** checkbox.

Parent topic: [Solutions When "No Signal" Message Appears](#)

Solutions When the Image is Not Rectangular

If the projected image is not evenly rectangular, try the following solutions:

- Place the projector directly in front of the center of the screen, facing it squarely, if possible.
- If you adjusted the projector height using the projector foot, press the keystone buttons on the projector to adjust the image shape.
- Adjust the image shape using the keystone settings in the projector's menu.
- Adjust the **Quick Corner** setting to correct the image shape.

Parent topic: [Solving Image or Sound Problems](#)

Related references

[Projector Feature Settings - Settings Menu](#)

Related tasks

[Adjusting the Image Height](#)

[Correcting Image Shape with H/V Keystone](#)

[Correcting Image Shape with Quick Corner](#)

Solutions When Only a Partial Image Appears

If only a partial computer image appears, try the following solutions:

- If you zoomed into or out of the image using the **Zoom** setting, press the ↩ return button on the projector remote control until the projector returns to a full display.
- Check the cables connecting the computer or video source to the projector. Try connecting different cables.
- Check your computer display settings to disable dual display and set the resolution within the projector's limits. (See your computer manual for details.)
- Check the resolution assigned to your presentation files to see if they are created for a different resolution than you are projecting in. (See your software help for details.)
- Make sure you selected the correct **Projection** setting.

Parent topic: [Solving Image or Sound Problems](#)

Related references

[Projector Feature Settings - Settings Menu](#)

Related tasks

[Connecting to an HDMI Video Source](#)

Solutions When the Image Contains Noise or Static

If the projected image seems to contain electronic interference (noise) or static, try the following solutions:

- Check the cables connecting your computer or video source to the projector. They should be:
 - Separated from the power cord to prevent interference
 - Securely connected at both ends
 - Not connected to an extension cable
 - No longer than 24 feet (7.3 m) for HDMI cables
- Try decreasing the **Sharpness** setting in the **Image** menu.
- Try adjusting the **Noise Reduction** or **MPEG Noise Reduction** setting in the **Image** menu.
- Select a computer video resolution and refresh rate that are compatible with the projector.

Parent topic: [Solving Image or Sound Problems](#)

Related references

[Image Quality Settings - Image Menu](#)

Related tasks

[Connecting to an HDMI Video Source](#)

Solutions When the Image is Fuzzy or Blurry

If the projected image is fuzzy or blurry, try the following solutions:

- Adjust the image focus.
- Clean the projection window.

Note: To avoid condensation on the lens after bringing the projector in from a cold environment, let the projector warm up to room temperature before using it.

- Try another projection surface.
- Position the projector close enough to the screen, and directly in front of it.
- Adjust the **Sharpness** setting to improve image quality.

- If you are projecting from a computer, adjust the computer's resolution to match the projector's native resolution, if possible.

Parent topic: [Solving Image or Sound Problems](#)

Related references

[Image Quality Settings - Image Menu](#)

Related tasks

[Focusing the Image Using the Focus Lever](#)

[Cleaning the Projection Window](#)

Solutions When the Image Brightness or Colors are Incorrect

If the projected image is too dark or light, or the colors are incorrect, try the following solutions:

- Try selecting a color mode that best fits the image and environment.
- Check your video source settings.
- Adjust the available settings on the Image menu, such as **Brightness**, **Contrast**, **Tint**, and/or **Color Saturation**.
- Make sure you selected the correct **HDMI Video Range** setting in the **Image** menu.
- Make sure the HDMI cable is securely connected to the projector and your video device. If you connected a long cable, try connecting a shorter cable.
- Position the projector close enough to the screen.

Parent topic: [Solving Image or Sound Problems](#)

Related references

[Image Quality Settings - Image Menu](#)

Related tasks

[Connecting to an HDMI Video Source](#)

[Changing the Color Mode](#)

Solutions to Sound Problems

If there is no sound when you expect it or the volume is too low or high, try the following solutions:

- Adjust the projector's volume settings.
- Press the  A/V mute button on the projector remote control to resume video and audio if they were temporarily stopped.

- Check the cable connection between the projector and your video source.
- If you are using a Mac and you do not hear sound from an HDMI source, make sure your Mac supports audio through the HDMI port. If not, you need to connect an audio cable directly to your speaker system.
- HDMI audio is only supported using PCM. Make sure your audio source is set to the PCM setting.
- If you turn the projector on immediately after turning it off, the cooling fans may run at high speed momentarily and cause an unexpected noise. This is normal.

Parent topic: [Solving Image or Sound Problems](#)

Related tasks

[Shutting Off the Picture and Sound Temporarily](#)

[Controlling the Volume with the Volume Buttons](#)

[Connecting to an HDMI Video Source](#)

Solutions to Bluetooth Audio Problems

If you cannot connect to a Bluetooth audio device, try the following solutions:

- Make sure the **Bluetooth Audio** setting is turned on in the **Settings** menu. If you are using the projector's speaker or headphones, turn this setting off.
- Select **Search Bluetooth Device** in the **Settings** menu when you pair a Bluetooth audio device for the first time or change to another Bluetooth audio device.
- Make sure the Bluetooth audio device is paired to the projector and not to another device.
- Make sure the Bluetooth audio device that is paired to the projector supports copyright protection (SCMS-T) and A2DP.
- Check the volume level on the paired Bluetooth audio device.
- Make sure there are no obstacles between the Bluetooth audio device and the projector and that the Bluetooth audio device is within the specified communication distance. Avoid using the projector near wireless networks, microwave ovens, 2.4 GHz cordless phones, or other devices that use the 2.4 GHz frequency band.

Parent topic: [Solving Image or Sound Problems](#)

Related references

[Projector Feature Settings - Settings Menu](#)

Related tasks

[Connecting to a Bluetooth Audio Device](#)

Solving Projector or Remote Control Operation Problems

Check the solutions in these sections if you have problems operating the projector or remote control.

[Solutions to Projector Power or Shut-Off Problems](#)

[Solutions to Streaming Device Problems](#)

[Solutions to Remote Control Problems](#)

Parent topic: [Solving Problems](#)

Solutions to Projector Power or Shut-Off Problems

If the projector does not come on when you press the power button or it shuts off unexpectedly, try the following solutions:

- Make sure the power cord is securely connected to the projector and to a working electrical outlet.
- The projector's buttons may be locked for security. Unlock the buttons or use the projector remote control to turn on the projector.
- If the projector's laser shuts off unexpectedly, it may have entered standby mode after a period of inactivity. Press the power button to wake the projector and adjust the **Sleep Mode** setting to change the sleep interval.
- If the projector is installed on a lighting track, disconnect it from the lighting track and plug it into a power outlet to make sure it is working.
- If the projector's light source shuts off, the status light is flashing blue, and the temp light is orange, the projector has overheated and shut off. Check the solutions for this light status.
- The power cord may be defective. Try another power cord. If that doesn't work, disconnect the cord and contact Epson.

Parent topic: [Solving Projector or Remote Control Operation Problems](#)

Related references

[Projector Feature Settings - Settings Menu](#)

[Projector Light Status](#)

Related tasks

[Unlocking the Projector's Buttons](#)

Solutions to Streaming Device Problems

If you cannot operate the Epson streaming device included with your projector using the projector remote control, try the following solutions:

- Make sure the streaming device is securely connected to the projector's HDMI extension cable and USB power cable.
- Make sure the streaming device is connected to Wi-Fi. You need an Internet connection to view online streaming content.
- Make sure the projector remote control is paired to the streaming device.
- Make sure you are using the projector remote control and not the remote control for Android TV.

Caution: The streaming device included with your projector is designed for use with this projector. Epson takes no responsibility for repair costs incurred by connecting any other streaming device to your projector.

Parent topic: [Solving Projector or Remote Control Operation Problems](#)

Related tasks

[Pairing the Projector Remote Control](#)

Solutions to Remote Control Problems

If the projector does not respond to remote control commands, try the following solutions:

- Check that the remote control batteries are installed correctly and have power. If necessary, replace the batteries.
- Make sure you are operating the remote control within the reception angle and range of the projector.
- Make sure the projector is not warming up or shutting down.
- Check to see if a button on the remote control is stuck down, causing it to enter sleep mode. Release the button to wake the remote control up.
- Make sure the projector remote control is paired to the streaming device to operate Android TV features (if applicable).
- Make sure you are using the projector remote control and not the remote control for Android TV.
- Strong fluorescent lighting, direct sunlight, or infrared device signals may be interfering with the projector's remote receivers. Dim the lights or move the projector away from the sun or interfering equipment.
- If you lose the remote control, you can purchase another from an authorized Epson reseller.

Parent topic: [Solving Projector or Remote Control Operation Problems](#)

Related references

[Remote Control Operation](#)

[Projector Parts - Remote Control](#)

Related tasks

[Replacing the Remote Control Batteries](#)

[Pairing the Projector Remote Control](#)

Solutions to HDMI Link Problems

If you cannot control an HDMI device using the HDMI Link buttons, try the following solutions:

- Make sure all necessary cables are securely connected and the power is on for the projector and connected video sources.
- Make sure the cables meet the HDMI CEC standard.
- Make sure the connected device meets the HDMI CEC standard. See the documentation supplied with the device for more information.
- Make sure the **HDMI Link** setting is set to **On**.
- Check if the device is available in the **Device Connections** list in the **Settings** menu. If the device does not appear, it does not meet the HDMI CEC standards. Connect a different device.
- Make sure the connected devices are turned on and in standby status. See the documentation supplied with the device for more information.
- If you connected a new device or changed any connections, make sure the CEC function is set for the connected device. You may need to restart the device.
- If you have connected a speaker or receiver, set the output to PCM.

Parent topic: [Solving Problems](#)

Related references

[Projector Feature Settings - Settings Menu](#)

Related tasks

[Connecting to an HDMI Video Source](#)

Where to Get Help (U.S. and Canada)

If you need to contact Epson for technical support services, use the following support options.

Internet Support

Visit Epson's support website at epson.com/support (U.S.), epson.ca/support (Canada), or epson.com.jm/support (Caribbean) and select your product for solutions to common problems with your projector. You can download utilities and documentation, get FAQs and troubleshooting advice, or e-mail Epson with your questions.

Speak to a Support Representative

To use the Epson PrivateLine Support service, call (800) 637-7661. This service is available for the duration of your warranty period. You may also speak with a projector support specialist by dialing (562) 276-4394 (U.S.) or (905) 709-3839 (Canada).

Support hours are 6 AM to 8 PM, Pacific Time, Monday through Friday and 7 AM to 4 PM, Pacific Time, Saturday.

Days and hours of support are subject to change without notice. Toll or long distance charges may apply.

Before you call, have the following information ready:

- Product name
- Product serial number (located on the bottom or rear of the projector, or in the menu system)
- Proof of purchase (such as a store receipt) and date of purchase
- Computer or video configuration
- Description of the problem

Purchase Supplies and Accessories

You can purchase screens, other optional accessories, and replacement parts from an Epson authorized reseller. To find the nearest reseller, call 800-GO-EPSON (800-463-7766) in the U.S. or 800-807-7766 in Canada. Or you can purchase online at epsonstore.com (U.S. sales) or epsonstore.ca (Canadian sales).

To purchase a replacement remote control, call (562) 276-4394 (U.S.) or (905) 709-3839 (for dealer referral in Canada).

Parent topic: [Solving Problems](#)

Where to Get Help (Latin America)

If you need to contact Epson for technical support services, use the following support options.

Internet Support

Visit Epson's support website at epson.com.jm/support and select your product for solutions to common problems. You can download utilities and documentation, get FAQs and troubleshooting advice, or e-mail Epson with your questions.

Speak to a Support Representative

Before you call for support, please have the following information ready:

- Product name
- Product serial number (located on the bottom or rear of the projector, or in menu system)
- Proof of purchase (such as a store receipt) and date of purchase
- Computer or video configuration
- Description of the problem

Then call:

Country	Telephone
Argentina	(54 11) 5167-0300 0800-288-37766
Bolivia*	800-100-116
Brazil	0800-007-5000
Chile	(56 2) 2484-3400
Colombia	Bogota: (57 1) 592-2200 Other cities: 018000-915235
Costa Rica	800-377-6627
Dominican Republic*	1-888-760-0068
Ecuador*	1-800-000-044
El Salvador*	800-6570
Guatemala*	1-800-835-0358
Mexico	Mexico City: (52 55) 1323-2052 Other cities: 01-800-087-1080

Country	Telephone
Nicaragua*	00-1-800-226-0368
Panama*	00-800-052-1376
Paraguay	009-800-521-0019
Peru	Lima: (51 1) 418-0210 Other cities: 0800-10-126
Uruguay	00040-5210067
Venezuela	(58 212) 240-1111

* Contact your local phone company to call this toll-free number from a mobile phone.

Note: Toll or long distance charges may apply. If your country does not appear on the list, contact the sales office in the nearest country.

Purchase Supplies and Accessories

You can purchase optional accessories and replacement parts from an Epson authorized reseller. To find the nearest reseller, go to [Where to Get Help](#). Or you can contact your nearest sales office as described in "Where to Get Help".

Parent topic: [Solving Problems](#)

Technical Specifications

These sections list the technical specifications of your projector.

[General Projector Specifications](#)

[Projector Light Source Specifications](#)

[Projector Remote Control Specifications](#)

[Projector Dimension Specifications](#)

[Projector Electrical Specifications](#)

[Projector Environmental Specifications](#)

[Bluetooth Specifications](#)

[Streaming Device Specifications](#)

[Projector Safety and Approvals Specifications](#)

[Supported Video Display Formats](#)

General Projector Specifications

Type of display	Poly-silicon TFT active matrix
Resolution	1280 × 800 pixels (WXGA)
Lens	F=1.58 Focal length: 13.53 mm
Color reproduction	Up to 16.77 million colors
Brightness (with Dynamic Color Mode and Wide Zoom)	Normal Light Output mode: White light output 2000 lumens (ISO 21118 standard) Color light output 2000 lumens ECO Light Output mode: White light output 1000 lumens (ISO 21118 standard)

Note: Color brightness (color light output) and white brightness (white light output) will vary depending on usage conditions. Color light output measured in accordance with IDMS 15.4; white light output measured in accordance with ISO 21118.

Contrast ratio	Over 2,500,000:1 with Dynamic Color Mode, Normal Light Output, Wide zoom, and Dynamic Contrast on
Image size (in native aspect ratio)	22 inches (0.56 m) to 111 inches (2.82 m) with Tele zoom 30 inches (0.76 m) to 150 inches (3.81 m) with Wide zoom
Projection distance (in native aspect ratio)	25.6 inches (0.65 m) to 134.2 inches (3.41 m)
Projection methods	Front, rear, ceiling-mounted, ceiling
Optical aspect ratio (width-to-height)	16:10
Focus adjustment	Manual
Zoom adjustment	Digital
Zoom ratio (Tele-to-Wide)	1.0 to 1.35
Internal sound system	5 W monaural
Noise level	29 dB (Normal Light Output mode) 26 dB (ECO Light Output mode)
Keystone correction angle	Vertical: $\pm 45^\circ$ Horizontal: $\pm 40^\circ$
USB Type B port compatibility (mini USB)	USB 1.1 and 2.0 compliant for copying menu settings and firmware updating
USB Type A port compatibility	One USB 1.1 and 2.0 compliant port for 2 A power supply, copying menu settings, and firmware updating

Parent topic: [Technical Specifications](#)

Projector Light Source Specifications

Type	Laser diode
Light source output power	Up to 43 W
Wavelength	449 to 461 nm

Light source life
(approximate)

Light Output 100%:
Up to about 12000 hours
Light Output 50%:
Up to about 20000 hours

Note: Turn off this product when not in use to prolong the life of the projector. Laser life will vary depending upon mode selected, environmental conditions, and usage. Brightness decreases over time.

Parent topic: [Technical Specifications](#)

Projector Remote Control Specifications

Reception range 16.4 feet (5 m)
Batteries Two alkaline or manganese AAA

Parent topic: [Technical Specifications](#)

Projector Dimension Specifications

Height (excluding foot) 3.46 inches (88 mm)
Width 8.27 inches (210 mm)
Depth 8.94 inches (227 mm)
Weight 5.96 lb (2.7 kg)

For mounting

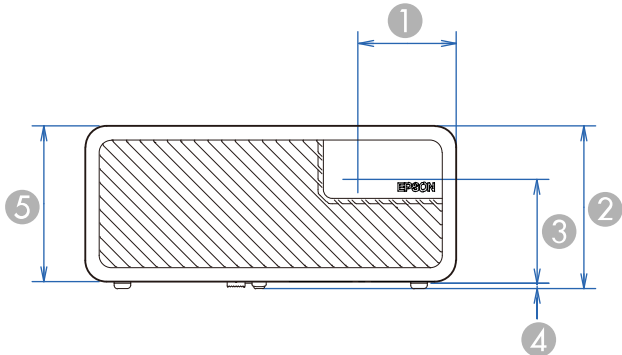

- 1 Center of lens: 2.17 inches (55 mm)
- 2 3.62 inches (92 mm)
- 3 2.31 inches (58.8 mm)
- 4 0.12 inch (3 mm)

5 3.46 inches (88 mm)

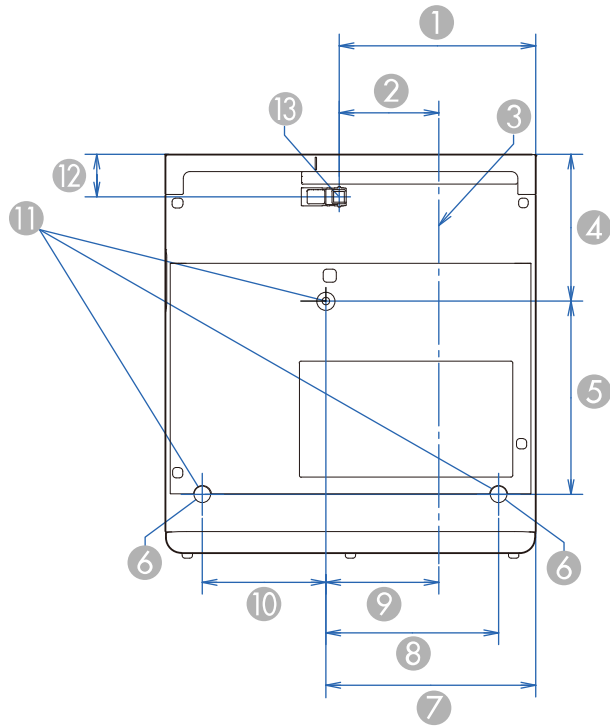

- 1 4.39 inches (111.4 mm)
- 2 2.22 inches (56.4 mm)
- 3 Center of lens
- 4 3.29 inches (83.6 mm)
- 5 4.33 inches (110 mm)
- 6 Rear foot
- 7 4.69 inches (119 mm)
- 8 3.86 inches (98 mm)
- 9 2.52 inches (64 mm)

- 10 2.76 inches (70 mm)
- 11 M4×9mm screws (3)
- 12 0.95 inch (24.2 mm)
- 13 Front adjustable foot

Parent topic: [Technical Specifications](#)

Projector Electrical Specifications

Rated frequency	50/60 Hz
Power supply	100 to 240 V AC ±10%
	1.8 to 0.9 A
Power consumption (100 to 120 V)	Operating: 178 W at 100% Light Output 118 W at 50% Light Output Standby: 0.4 W
Power consumption (220 to 240 V)	Operating: 172 W at 100% Light Output 115 W at 50% Light Output Standby: 0.4 W

Parent topic: [Technical Specifications](#)

Projector Environmental Specifications

Temperature	Operating: At 0 to 7500 ft (2286 m) altitude: 41 to 95 °F (5 to 35 °C) At 7500 ft (2286 m) to 9842 ft (3000 m) altitude: 41 to 86 °F (5 to 30 °C) Storage: 14 to 140 °F (–10 to 60 °C)
--------------------	---

Humidity	Operating: 20 to 80%
(relative, non-condensing)	Storage: 10 to 90%
Operating altitude	Up to 4921 feet (1500 m)
	Up to 9843 ft (3000 m) with High Altitude Mode enabled

Parent topic: [Technical Specifications](#)

Bluetooth Specifications

Version	Bluetooth Ver. 3.0
Output	Class 2
Communication distance	Approximately 32.8 ft (10 m)
Supported profiles	A2DP
Content protection	SCMS-T
Frequency used	2.4 GHz band (2.402 to 2.480 GHz)
Supported codecs	SBC, Qualcomm aptX audio

Parent topic: [Technical Specifications](#)

Streaming Device Specifications

Power supply	5V, 2A
Dimensions	Length: 3.7 inches (94.1 mm)
	Width: 1.19 inches (30.1 mm)
	Depth: 0.47 inch (12 mm)
Weight	1 ounce (28 g)
Temperature	Operating:
(no condensation)	41 to 95 °F (5 to 35 °C)
	Storage:
	14 to 140 °F (–10 to 60 °C)

Humidity	10 to 90%
HDMI version	1.4, 2.0
Wireless LAN	IEEE 802.11a (5 GHz) IEEE 802.11b (2.4 GHz) IEEE 802.11g (2.4 GHz) IEEE 802.11n (2.4 GHz and 5 GHz) IEEE 802.11ac (2.4 GHz and 5 GHz)
Bluetooth	Bluetooth 4.2 Class 2 (2.4 GHz)

Parent topic: [Technical Specifications](#)

Projector Safety and Approvals Specifications

United States	FCC Part 15 Class B (DoC) UL60950-1 2nd edition (cTUVus Mark)
Canada	ICES-003 Class B CSA C22.2 No. 60950-1

Parent topic: [Technical Specifications](#)

Supported Video Display Formats

For best results, your computer's monitor port or video card resolution should be set to display in the projector's native resolution. However, your projector includes Epson's SizeWise chip that supports other computer display resolutions, so your image will be resized to fit automatically.

Your computer's monitor port or video card refresh rate (vertical frequency) must be compatible with the projector. (See your computer or video card manual for details.)

The table here lists the compatible refresh rate and resolution for each compatible video display format via HDMI (HDCP version 1.4).

Display format	Refresh rate (in Hz)	Resolution (in pixels)
VGA	60	640 × 480
SDTV (480i/480p)	59.94	720 × 480

Display format	Refresh rate (in Hz)	Resolution (in pixels)
SDTV (576i/576p)	50	720 × 576
HDTV (720p)	50/59.94/60	1280 × 720
HDTV (1080i)	50/59.94/60	1920 × 1080
HDTV (1080p)	23.98/24/29.97/30/50/59.94/60	1920 × 1080

Parent topic: [Technical Specifications](#)

Notices

Check these sections for important notices about your projector.

[Recycling](#)

[Important Safety Information](#)

[Laser Safety Information](#)

[Important Safety Instructions](#)

[List of Safety Symbols](#)

[FCC Compliance Statement](#)

[Binding Arbitration and Class Waiver](#)

[Trademarks](#)

[Copyright Notice](#)

Recycling

Epson offers a recycling program for end of life products. Please go to [this site](#) for information on how to return your products for proper disposal.

Parent topic: [Notices](#)

Important Safety Information

Caution: Never look into the projector lens when the laser is turned on; the bright light can damage your eyes. Never let children look into the lens when it is on. Never open any cover on the projector, except the filter covers. Dangerous electrical voltages inside the projector can severely injure you. Except as specifically explained in this *User's Guide*, do not attempt to service this product yourself. Refer all servicing to qualified service personnel.

Warning: The projector and its accessories come packaged in plastic bags. Keep plastic bags away from small children to avoid any risk of suffocation.

Parent topic: [Notices](#)

Laser Safety Information

This projector is a Class 2 laser product that complies with the IEC/EN60825-1:2007 international standard for lasers. Follow these safety instructions when using the projector.

Warning: Possibly hazardous optical radiation emitted from this product. Do not look at operating light source. Eye injury may result.

- If an error occurs in the projector, turn off the power and unplug the projector immediately. Continuing to use the projector could result in an electric shock, fire, or visual impairment. Contact Epson support.
- Do not attempt to disassemble or modify the projector. The projector contains a high-power laser component. Serious injury could result.
- Do not look into the lens during projection. Also, do not look into the lens using optical devices, such as a magnifying glass or telescope. This could cause visual impairment.
- When turning on the projector at a distance using the remote control, make sure no one is looking into the lens.
- Do not allow small children to operate the projector. Children must be accompanied by an adult.
- Do not apply optical devices, such as a magnifying glass or reflector, to the projected image. Using the projector may result in physical harm, fire, or an accident.
- Do not block the light from the lens during projection. The high temperature in this area could cause burns, fire, or other damage. The lens may overheat due to the reflected light and could cause the projector to malfunction.
- Before using the projector, make sure there is nothing in the area that could reflect the projected image.
- When disposing of the projector, do not disassemble it. Dispose of the projector in accordance with your local or national laws and regulations.

Labels are attached to the projector to indicate it is a Class 2 laser product and complies with FDA performance standards for laser products except for deviations pursuant to Laser Notice No. 50, dated June 24, 2007:

• **Inside**



- Side

As with any bright source, do not stare into the beam (RG2 IEC/EN 62471-5:2015).

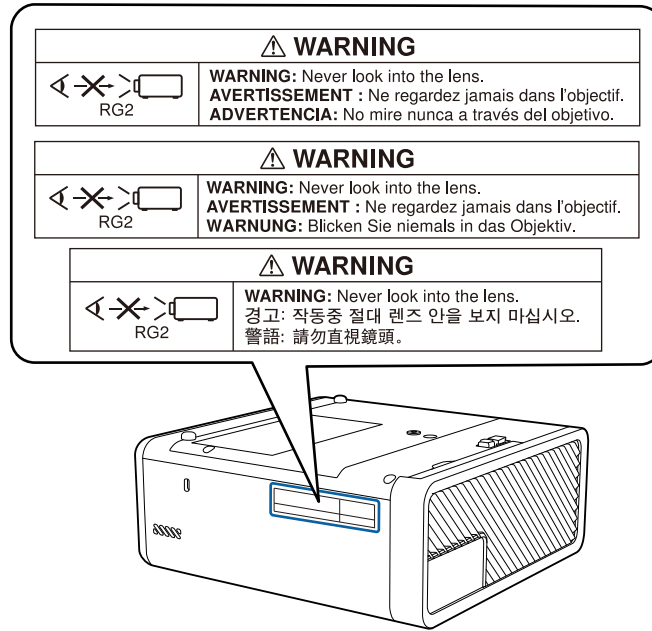

- **Base**

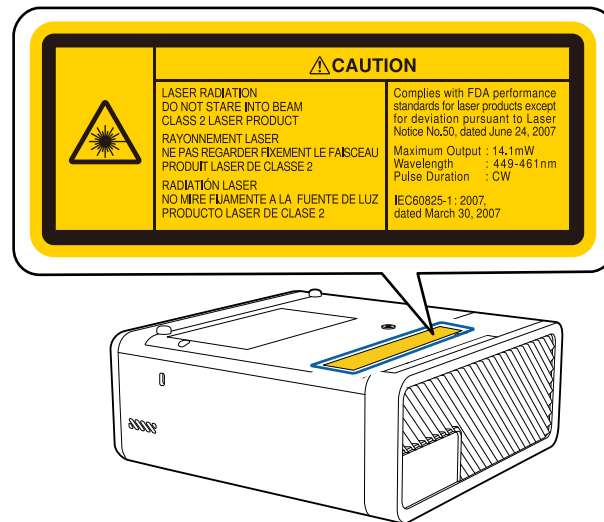

Parent topic: [Notices](#)

Important Safety Instructions

Follow these safety instructions when setting up and using the projector:

- Do not look into the lens when the projector is on. The bright light can damage your eyes. Avoid standing in front of the projector so the bright light does not shine into your eyes.
- When turning on the projector at a distance using the remote control, make sure there is no one looking into the lens.
- Do not cover the projection window. The internal temperature could rise and cause a fire.
- Do not place the projector on an unstable cart, stand, or table or on a surface that is unable to support its weight. Otherwise, it could fall or topple causing an accident and injury.
- If the projector is mounted on a ceiling or wall, it should be installed by qualified technicians using mounting hardware designed for use with this projector.
- When installing or adjusting a ceiling or wall mount, do not use adhesives to prevent the screws from loosening and do not use oils or lubricants. This may cause the projector case to crack and the projector to fall from its ceiling mount. This could cause serious injury to anyone under the mount and could damage the projector.

- Do not install the projector in locations exposed to high humidity and dust, such as on a kitchen counter, in the kitchen, or near a humidifier, or in locations exposed to oil smoke or steam. Doing so could cause fire or electric shock. In addition, the oil content could cause the projector's outer case to deteriorate and could cause the projector to fall off from the ceiling where it is suspended.
- Do not use the projector near water, sources of heat, high-voltage electrical wires, or sources of magnetic fields.
- Do not use the device near any medical equipment or equipment that is automatically controlled, such as automatic doors or fire alarms. Electromagnetic interference from the device may cause such equipment to malfunction and cause an accident.
- Use the type of power source indicated on the projector. Use of a different power source may result in fire or electric shock. If you are not sure of the power available, consult your dealer or power company.
- Place the projector near a wall outlet where the plug can be easily unplugged.
- Take the following precautions when handling the plug: Do not hold the plug with wet hands. Do not insert the plug into a dusty outlet. Insert the plug firmly into the outlet. Do not pull the power cord when disconnecting the plug; always be sure to hold the plug when disconnecting it. Do not overload wall outlets, extension cords, or power strips. Failure to comply with these precautions could result in fire or electric shock.
- Do not place the projector where the cord can be walked on. This may result in fraying or damage to the plug.
- Unplug the projector from the wall outlet and allow to cool before cleaning. Use a dry cloth (or, for stubborn dirt or stains, a moist cloth that has been wrung dry) for cleaning. Do not use liquid or aerosol cleaners, any sprays containing flammable gas, or solvents such as alcohol, paint thinner, or benzene.
- Do not block the slots and openings in the projector case. They provide ventilation and prevent the projector from overheating. Do not operate the projector on a sofa, rug, or other soft surface, or set it on top of loose papers. Do not cover the projector with a blanket, curtain, or tablecloth. If you are setting up the projector near a wall, leave at least 7.9 inches (20 cm) of space between the wall and the projector.
- Do not operate the projector in a closed-in cabinet unless proper ventilation is provided.
- Never allow objects of any kind to enter any openings in the projector. Do not leave objects, especially flammable objects, near the projector. Never spill liquid of any kind into the projector.
- If you are using two or more projectors side-by-side, leave enough space between the projectors to allow for proper ventilation.
- You may need to clean the air filter and vent. A clogged air filter or vent can block ventilation needed to cool the projector. Do not use canned air, or the gases may leave a residue.
- Do not store the projector outdoors for an extended length of time.

- Except as specifically explained in this manual, do not attempt to service this product yourself. Refer all servicing to qualified personnel. Opening or removing covers may expose you to dangerous voltages and other hazards.
- Never open any covers on the projector except as specifically explained in this manual. Never attempt to disassemble or modify the projector. Refer all repairs to qualified service personnel.
- Unplug the projector from the wall outlet and refer servicing to qualified service personnel under the following conditions: if it does not operate normally when you follow the operating instructions, or exhibits a distinct change in performance; if smoke, strange odors, or strange noises come from the projector; if the power cord or plug is damaged or frayed; if liquid or foreign objects get inside the projector, or if it has been exposed to rain or water; if it has been dropped or the housing has been damaged.
- Do not touch the plug during an electrical storm. Otherwise, you may receive an electric shock.
- Unplug the projector when it will not be used for extended periods.
- Do not use the projector where it may be exposed to rain, water, or excessive humidity.
- Do not use or store the projector where it may be exposed to smoke, steam, corrosive gases, excessive dust, vibration, or shock.
- Do not use the projector where flammable or explosive gases may be present.
- Do not use or store the projector or remote control in a hot location, such as near a heater, in direct sunlight, or in a closed vehicle.
- If you use the projector in a country other than where you purchased it, use the correct power cord for that country.
- Do not stand on the projector or place heavy objects on it.
- Do not use the projector outside of the required temperature range below:
41 to 95 °F (5 to 35 °C) at an altitude of 7500 feet (2286 m) or less, or 41 to 86 °F (5 to 30 °C) at an altitude of 7500 feet (2286 m) to 9842 feet (3000 m)
Doing so may cause an unstable display and could lead to projector damage. Do not use or store the projector where it may be exposed to sudden changes in temperature.
- Do not store the projector outside of the required temperature range of 14 to 140 °F (–10 to 60 °C) or in direct sunlight for long periods of time. Doing so may cause damage to the case.
- Do not place anything that can become warped or damaged by heat near the exhaust vents. Do not bring your hands or face close to the vents while projection is in progress. Do not bring your face close to the projector while it is in use.

- Before you move the projector, make sure its power is turned off, the plug is disconnected from the outlet, and all cables are disconnected.
- Do not place the source of an open flame, such as a lit candle, on or near the projector.
- During projection, do not block the light from the projector with a book or other objects. If the light from the projector is blocked, the area on which the light shines becomes hot which could cause it to melt, burn, or start a fire. Also, the lens may get hot due to the reflected light which could cause the projector to malfunction. To stop projection, use the A/V Mute function, or turn off the projector.
- Do not modify the power cord. Do not place heavy objects on top of the power cord or bend, twist, or pull it excessively. Keep the power cord away from hot electrical appliances.

[Restriction of Use](#)

Parent topic: [Notices](#)

Related tasks

[Cleaning the Air Filter and Vents](#)

[Turning Off the Projector](#)

Restriction of Use

When this product is used for applications requiring high reliability/safety such as transportation devices related to aviation, rail, marine, automotive; disaster prevention devices; various safety devices; or functional/precision devices, you should use this product only after giving consideration to including fail-safes and redundancies into your design to maintain safety and total system reliability.







Because this product was not intended for use in applications requiring extremely high reliability/safety such as aerospace equipment, main communication equipment, nuclear power control equipment, or medical equipment related to direct medical care, please make your own judgment on this product's suitability after a full evaluation.







Parent topic: [Important Safety Instructions](#)







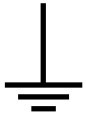

List of Safety Symbols







The following table lists the meaning of the safety symbols labeled on the equipment.

No.	Symbol	Approved Standards	Description
1		IEC60417 No.5007	"ON" (power) To indicate connection to the mains.

No.	Symbol	Approved Standards	Description
2		IEC60417 No.5008	"OFF" (power) To indicate disconnection from the mains.
3		IEC60417 No.5009	Stand-by To identify the switch or switch position by means of which part of the equipment is switched on in order to bring it into the stand-by condition.
4		ISO7000 No.0434B, IEC3864-B3.1	Caution To identify general caution when using the product.
5		IEC60417 No.5041	Caution, hot surface To indicate that the marked item can be hot and should not be touched without taking care.
6		IEC60417 No.6042 ISO3864-B3.6	Caution, risk of electric shock To identify equipment that has risk of electric shock.
7		IEC60417 No.5957	For indoor use only To identify electrical equipment designed primarily for indoor use.
8		IEC60417 No.5926	Polarity of DC power connector To identify the positive and negative connections (the polarity) on a piece of equipment to which a DC power supply may be connected.

No.	Symbol	Approved Standards	Description
9		—	Polarity of DC power connector To identify the positive and negative connections (the polarity) on a piece of equipment to which a DC power supply may be connected.
10		IEC60417 No.5001B	Battery, general On battery powered equipment. To identify a device for instance a cover for the battery compartment, or the connector terminals.
11		IEC60417 No.5002	Positioning of cell To identify the battery holder itself and to identify the positioning of the cell(s) inside the battery holder.
12		—	Positioning of cell To identify the battery holder itself and to identify the positioning of the cell(s) inside the battery holder.
13		IEC60417 No.5019	Protective earth To identify any terminal which is intended for connection to an external conductor for protection against electric shock in case of a fault, or the terminal of a protective earth electrode.
14		IEC60417 No.5017	Earth To identify an earth (ground) terminal in cases where neither the symbol No.13 is explicitly required.
15		IEC60417 No.5032	Alternating current To indicate on the rating plate that the equipment is suitable for alternating current only; to identify relevant terminals.

No.	Symbol	Approved Standards	Description
16		IEC60417 No.5031	Direct current To indicate on the rating plate that the equipment is suitable for direct current only; to identify relevant terminals.
17		IEC60417 No.5172	Class II equipment To identify equipment meeting the safety requirements specified for Class II equipment according to IEC 61140.
18		ISO 3864	General prohibition To identify actions or operations that are prohibited.
19		ISO 3864	Contact prohibition To indicate injury that could occur due to touching a specific part of the equipment.
20		—	Never look into the optical lens while the projector is on.
21		—	To indicate that the marked item don't place anything on projector.
22		ISO3864 IEC60825-1	Caution, laser radiation To indicate the equipment has a laser radiation part.
23		ISO 3864	Disassembly prohibition To indicate a risk of injury, such as electric shock, if the equipment is disassembled.

No.	Symbol	Approved Standards	Description
24		IEC60417 No. 5266	Standby, partial standby To indicate that part of the equipment is in the ready status.
25		ISO3864 IEC60417 No. 5057	Caution, movable parts To indicate that you must keep away from movable parts according to protection standards.
26		IEC60417 No. 6056	Caution, moving fan blades To indicate that you must keep away from moving fan blades.
27		IEC60417 No. 6043	Caution, sharp corners To indicate that you must not touch sharp corners.
28		—	To indicate that looking into the lens while projecting is prohibited.
29		ISO7010 No. W027 ISO3864	Warning, optical radiation (UV, visible light, IR, etc.) To indicate that you must be careful not to injure your eyes or skin when in the vicinity of optical radiation.
30		IEC60417 No. 5109	Not to be used in residential areas To indicate that the electrical equipment is not suitable for a residential area.

Parent topic: [Notices](#)

FCC Compliance Statement

For United States Users

This equipment has been tested and found to comply with the limits for a Class B digital device, pursuant to Part 15 of the FCC Rules. These limits are designed to provide reasonable protection against harmful interference in a residential installation. This equipment generates, uses, and can radiate radio frequency energy and, if not installed and used in accordance with the instructions, may cause harmful interference to radio communications. However, there is no guarantee that interference will not occur in a particular installation. If this equipment does cause interference to radio and television reception, which can be determined by turning the equipment off and on, the user is encouraged to try to correct the interference by one or more of the following measures:

- Reorient or relocate the receiving antenna.
- Increase the separation between the equipment and receiver.
- Connect the equipment into an outlet on a circuit different from that to which the receiver is connected.
- Consult the dealer or an experienced radio/TV technician for help.

This device complies with part 15 of the FCC Rules. Operation is subject to the following two conditions: (1) This device may not cause harmful interference, and (2) this device must accept any interference received, including interference that may cause undesired operation.

WARNING

The connection of a non-shielded equipment interface cable to this equipment will invalidate the FCC Certification or Declaration of this device and may cause interference levels which exceed the limits established by the FCC for this equipment. It is the responsibility of the user to obtain and use a shielded equipment interface cable with this device. If this equipment has more than one interface connector, do not leave cables connected to unused interfaces. Changes or modifications not expressly approved by the manufacturer could void the user's authority to operate the equipment.

For Canadian Users

CAN ICES-3(B)/NMB-3(B)

Parent topic: [Notices](#)

Binding Arbitration and Class Waiver

1. DISPUTES, BINDING INDIVIDUAL ARBITRATION, AND WAIVER OF CLASS ACTIONS AND CLASS ARBITRATIONS

1.1 **Disputes.** The terms of this Section 1 shall apply to all Disputes between you and Epson. The term "Dispute" is meant to have the broadest meaning permissible under law and includes any dispute, claim, controversy or action between you and Epson arising out of or relating to this Agreement, Epson branded products (hardware and including any related software), or other transaction involving you and Epson, whether in contract, warranty, misrepresentation, fraud, tort, intentional tort, statute, regulation, ordinance, or any other legal or equitable basis. "DISPUTE" DOES NOT INCLUDE IP CLAIMS, or more specifically, a claim or cause of action for (a) trademark infringement or dilution, (b) patent infringement, (c) copyright infringement or misuse, or (d) trade secret misappropriation (an "IP Claim"). You and Epson also agree, notwithstanding Section 1.6, that a court, not an arbitrator, may decide if a claim or cause of action is for an IP Claim.

1.2 **Binding Arbitration.** You and Epson agree that all Disputes shall be resolved by binding arbitration according to this Agreement. **ARBITRATION MEANS THAT YOU WAIVE YOUR RIGHT TO A JUDGE OR JURY IN A COURT PROCEEDING AND YOUR GROUNDS FOR APPEAL ARE LIMITED.**

Pursuant to this Agreement, binding arbitration shall be administered by JAMS, a nationally recognized arbitration authority, pursuant to its code of procedures then in effect for consumer related disputes, but excluding any rules that permit joinder or class actions in arbitration (for more detail on procedure, see Section 1.6 below). You and Epson understand and agree that (a) the Federal Arbitration Act (9 U.S.C. §1, et seq.) governs the interpretation and enforcement of this Section 1, (b) this Agreement memorializes a transaction in interstate commerce, and (c) this Section 1 shall survive termination of this Agreement.

1.3 **Pre-Arbitration Steps and Notice.** Before submitting a claim for arbitration, you and Epson agree to try, for sixty (60) days, to resolve any Dispute informally. If Epson and you do not reach an agreement to resolve the Dispute within the sixty (60) days, you or Epson may commence an arbitration. Notice to Epson must be addressed to: Epson America, Inc., ATTN: Legal Department, 3840 Kilroy Airport Way, Long Beach, CA 90806 (the "Epson Address"). The Dispute Notice to you will be sent to the most recent address Epson has in its records for you. For this reason, it is important to notify us if your address changes by emailing us at EAILEgal@ea.epson.com or writing us at the Epson Address above. Notice of the Dispute shall include the sender's name, address and contact information, the facts giving rise to the Dispute, and the relief requested (the "Dispute Notice"). Following receipt of the Dispute Notice, Epson and you agree to act in good faith to resolve the Dispute before commencing arbitration.

1.4 **Small Claims Court.** Notwithstanding the foregoing, you may bring an individual action in the small claims court of your state or municipality if the action is within that court's jurisdiction and is pending only in that court.

1.5 WAIVER OF CLASS ACTIONS AND CLASS ARBITRATIONS. YOU AND EPSON AGREE THAT EACH PARTY MAY BRING DISPUTES AGAINST THE OTHER PARTY ONLY IN AN INDIVIDUAL CAPACITY, AND NOT AS A PLAINTIFF OR CLASS MEMBER IN ANY CLASS OR REPRESENTATIVE PROCEEDING, INCLUDING WITHOUT LIMITATION FEDERAL OR STATE CLASS ACTIONS, OR CLASS ARBITRATIONS. CLASS ACTION LAWSUITS, CLASS-WIDE ARBITRATIONS, PRIVATE ATTORNEY-GENERAL ACTIONS, AND ANY OTHER PROCEEDING WHERE SOMEONE ACTS IN A REPRESENTATIVE CAPACITY ARE NOT ALLOWED. ACCORDINGLY, UNDER THE ARBITRATION PROCEDURES OUTLINED IN THIS SECTION, AN ARBITRATOR SHALL NOT COMBINE OR CONSOLIDATE MORE THAN ONE PARTY'S CLAIMS WITHOUT THE WRITTEN CONSENT OF ALL AFFECTED PARTIES TO AN ARBITRATION PROCEEDING.

1.6 Arbitration Procedure. If you or Epson commences arbitration, the arbitration shall be governed by the rules of JAMS that are in effect when the arbitration is filed, excluding any rules that permit arbitration on a class or representative basis (the "JAMS Rules"), available at <http://www.jamsadr.com> or by calling 1-800-352-5267 (U.S. or Canada), or <https://www.jamsadr.com/about/> or by calling +1-949-224-1810 (Latin America), and under the rules set forth in this Agreement. All Disputes shall be resolved by a single neutral arbitrator, and both parties shall have a reasonable opportunity to participate in the selection of the arbitrator. The arbitrator is bound by the terms of this Agreement. The arbitrator, and not any federal, state or local court or agency, shall have exclusive authority to resolve all disputes arising out of or relating to the interpretation, applicability, enforceability or formation of this Agreement, including any claim that all or any part of this Agreement is void or voidable. Notwithstanding this broad delegation of authority to the arbitrator, a court may determine the limited question of whether a claim or cause of action is for an IP Claim, which is excluded from the definition of "Disputes" in Section 1.1 above. The arbitrator shall be empowered to grant whatever relief would be available in a court under law or in equity. The arbitrator may award you the same damages as a court could, and may award declaratory or injunctive relief only in favor of the individual party seeking relief and only to the extent necessary to provide relief warranted by that party's individual claim. In some instances, the costs of arbitration can exceed the costs of litigation and the right to discovery may be more limited in arbitration than in court. The arbitrator's award is binding and may be entered as a judgment in any court of competent jurisdiction.

You may choose to engage in arbitration hearings by telephone. Arbitration hearings not conducted by telephone shall take place in a location reasonably accessible from your primary residence, or in Orange County, California, at your option.

a) Initiation of Arbitration Proceeding. If either you or Epson decides to arbitrate a Dispute, both parties agree to the following procedure:

(i) Write a Demand for Arbitration. The demand must include a description of the Dispute and the amount of damages sought to be recovered. You can find a copy of a Demand for Arbitration at <http://www.jamsadr.com> ("Demand for Arbitration").

(ii) Send three copies of the Demand for Arbitration, plus the appropriate filing fee, to: JAMS, 500 North State College Blvd., Suite 600 Orange, CA 92868, U.S.A.

(iii) Send one copy of the Demand for Arbitration to the other party (same address as the Dispute Notice), or as otherwise agreed by the parties.

b) Hearing Format. During the arbitration, the amount of any settlement offer made shall not be disclosed to the arbitrator until after the arbitrator determines the amount, if any, to which you or Epson is entitled. The discovery or exchange of non-privileged information relevant to the Dispute may be allowed during the arbitration.

c) Arbitration Fees. Epson shall pay, or (if applicable) reimburse you for, all JAMS filings and arbitrator fees for any arbitration commenced (by you or Epson) pursuant to provisions of this Agreement.

d) Award in Your Favor. For Disputes in which you or Epson seeks \$75,000 or less in damages exclusive of attorney's fees and costs, if the arbitrator's decision results in an award to you in an amount greater than Epson's last written offer, if any, to settle the Dispute, Epson will: (i) pay you \$1,000 or the amount of the award, whichever is greater; (ii) pay you twice the amount of your reasonable attorney's fees, if any; and (iii) reimburse you for any expenses (including expert witness fees and costs) that your attorney reasonably accrues for investigating, preparing, and pursuing the Dispute in arbitration. Except as agreed upon by you and Epson in writing, the arbitrator shall determine the amount of fees, costs, and expenses to be paid by Epson pursuant to this Section 1.6d).

e) Attorney's Fees. Epson will not seek its attorney's fees and expenses for any arbitration commenced involving a Dispute under this Agreement. Your right to attorney's fees and expenses under Section 1.6d) above does not limit your rights to attorney's fees and expenses under applicable law; notwithstanding the foregoing, the arbitrator may not award duplicative awards of attorney's fees and expenses.

1.7 Opt-out. You may elect to opt-out (exclude yourself) from the final, binding, individual arbitration procedure and waiver of class and representative proceedings specified in this Agreement by sending a written letter to the Epson Address within thirty (30) days of your assent to this Agreement (including without limitation the purchase, download, installation of the Software or other applicable use of Epson Hardware, products and services) that specifies (i) your name, (ii) your mailing address, and (iii) your request to be excluded from the final, binding individual arbitration procedure and waiver of class and representative proceedings specified in this Section 1. In the event that you opt-out consistent with the procedure set forth above, all other terms shall continue to apply, including the requirement to provide notice prior to litigation.

1.8 Amendments to Section 1. Notwithstanding any provision in this Agreement to the contrary, you and Epson agree that if Epson makes any future amendments to the dispute resolution procedure and class action waiver provisions (other than a change to Epson's address) in this Agreement, Epson will obtain your affirmative assent to the applicable amendment. If you do not affirmatively assent to the applicable amendment, you are agreeing that you will arbitrate any Dispute between the parties in

accordance with the language of this Section 1 (or resolve disputes as provided for in Section 1.7, if you timely elected to opt-out when you first assented to this Agreement).

1.9 Severability. If any provision in this Section 1 is found to be unenforceable, that provision shall be severed with the remainder of this Agreement remaining in full force and effect. **The foregoing shall not apply to the prohibition against class or representative actions as provided in Section 1.5. This means that if Section 1.5 is found to be unenforceable, the entire Section 1 (but only Section 1) shall be null and void.**

Parent topic: [Notices](#)

Trademarks

EPSON® and Quick Corner® are registered trademarks and EPSON Exceed Your Vision is a registered logomark of Seiko Epson Corporation.

SizeWise™ is a trademark of Epson America, Inc.

Windows is a registered trademark of Microsoft Corporation in the United States and/or other countries.

Apple and Mac are trademarks of Apple Inc., registered in the U.S. and other countries.

Google and Android TV are trademarks of Google LLC.

Qualcomm aptX is a product of Qualcomm Technologies, Inc. and/or its subsidiaries.

Qualcomm is a trademark of Qualcomm Incorporated, registered in the United States and other countries. aptX is a trademark of Qualcomm Technologies International, Ltd., registered in the United States and other countries.

General Notice: Other product names used herein are for identification purposes only and may be trademarks of their respective owners. Epson disclaims any and all rights in those marks.



Parent topic: [Notices](#)

Copyright Notice

All rights reserved. No part of this publication may be reproduced, stored in a retrieval system, or transmitted in any form or by any means, electronic, mechanical, photocopying, recording, or otherwise, without the prior written permission of Seiko Epson Corporation. The information contained herein is

designed only for use with this Epson product. Epson is not responsible for any use of this information as applied to other products.

Neither Seiko Epson Corporation nor its affiliates shall be liable to the purchaser of this product or third parties for damages, losses, costs, or expenses incurred by purchaser or third parties as a result of: accident, misuse, or abuse of this product or unauthorized modifications, repairs, or alterations to this product, or (excluding the U.S.) failure to strictly comply with Seiko Epson Corporation's operating and maintenance instructions.

Seiko Epson Corporation shall not be liable for any damages or problems arising from the use of any options or any consumable products other than those designated as Original Epson Products or Epson Approved Products by Seiko Epson Corporation.

Bluetopia is provided for your use by Stonestreet One, LLC under a software license agreement. Stonestreet One, LLC is and shall remain the sole owner of all right, title and interest whatsoever in and to Bluetopia and your use is subject to such ownership and to the license agreement. Stonestreet One, LLC reserves all rights related to Bluetopia not expressly granted under the license agreement and no other rights or licenses are granted either directly or by implication, estoppel or otherwise, or under any patents, copyrights, mask works, trade secrets or other intellectual property rights of Stonestreet One, LLC. © 2000-2012 Stonestreet One, LLC All Rights Reserved.

This information is subject to change without notice.

[A Note Concerning Responsible Use of Copyrighted Materials](#)
[Copyright Attribution](#)

Parent topic: [Notices](#)

A Note Concerning Responsible Use of Copyrighted Materials

Epson encourages each user to be responsible and respectful of the copyright laws when using any Epson product. While some countries' laws permit limited copying or reuse of copyrighted material in certain circumstances, those circumstances may not be as broad as some people assume. Contact your legal advisor for any questions regarding copyright law.

Parent topic: [Copyright Notice](#)

Copyright Attribution

© 2019 Epson America, Inc.

12/19

CPD-57699

Parent topic: [Copyright Notice](#)

Free Manuals Download Website

<http://myh66.com>

<http://usermanuals.us>

<http://www.somanuals.com>

<http://www.4manuals.cc>

<http://www.manual-lib.com>

<http://www.404manual.com>

<http://www.luxmanual.com>

<http://aubethermostatmanual.com>

Golf course search by state

<http://golfingnear.com>

Email search by domain

<http://emailbydomain.com>

Auto manuals search

<http://auto.somanuals.com>

TV manuals search

<http://tv.somanuals.com>