

Model: H928A,H930A,H931A

User's Guide

EH-TW9400

EH-TW8400W

EH-TW8400

Pro Cinema 6050UB

Home Cinema 5050UBe

Home Cinema 5050UB

LCD Projector

Using Each Guide

The guides for this projector are organized as shown below.

Safety Instructions/Support and Service Guide

Contains information on using the projector safely, as well as a support and service guide, troubleshooting check lists, and so on. Make sure you read this guide before using the projector.



User's Guide (this guide)

Contains information on setting up and basic operations before using the projector, using the Configuration menu, and handling problems and performing routine maintenance.



WirelessHD Transmitter User's Guide (H931A/EH-TW8400W/Home Cinema

5050UBe only) Contains information on handling the WirelessHD Transmitter and warnings and so on.



Quick Start Guide

Contains information on the procedures for setting up the projector. Read this first.

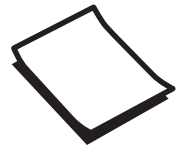



Notations Used in This Guide

Safety Indications

The documentation and the projector use graphical symbols to show how to use the projector safely. The following shows the symbols and their meanings. Please understand and respect these caution symbols in order to avoid injury to persons or property.

Warning

This symbol indicates information that, if ignored, could possibly result in personal injury or even death due to incorrect handling.



Caution

This symbol indicates information that, if ignored, could possibly result in personal injury or physical damage due to incorrect handling.

General Information Indications

Attention

Indicates procedures which may result in damage or malfunctions to occur.

	Indicates additional information and points which may be useful to know regarding a topic.
	Indicates a page where detailed information regarding a topic can be found.
Menu Name	Indicates Configuration menu items. Example: Image - Color Mode
Button Name	Indicates the buttons on the remote control or the control panel. Example:  button

About the Use of "This Product" or "This Projector"

As well as the main projector unit, supplied items or optional extras may be referred to using the phrase "this product" or "this projector".

Organization of the Guide and Notations in the Guide

Using Each Guide	1
Notations Used in This Guide	2
Safety Indications	2
General Information Indications	2
About the Use of "This Product" or "This Projector"	2

Introduction

Part Names and Functions	6
Front/Top	6
Control Panel	7
Remote Control	9
Rear	12
Base	13

Preparing

Installing	14
Projected Image and Position of Projector	14
Installing in parallel with the screen	14
Installing the projector horizontally by adjusting the height of either side	14
Various Setting Methods	15
Placing on a table and projecting	15
Suspending from the ceiling and projecting	16
Projection Distance and Lens Shift Maximum Values	16
Connecting a Device	19
Removing the Terminal Cover	19
Connecting Video Equipment	19
Connecting a Computer	20
Connecting External Equipment	20
Connecting to the Trigger Out port	20
Connecting WirelessHD devices (EH- TW9400W/EH-TW8400W only)	20
Connecting to the LAN port	21
Attaching the Wireless LAN unit	21
Connecting an HDMI Cable Clamp	22
Preparing the Remote Control	23

Installing the Remote Control Batteries	23
Remote Control Operating Range	24
Operating range (left to right)	24
Operating range (top to bottom)	24

Basic Operations

Projecting Images	25
Turning On the Projector	25
If the target image is not projected	26
Using the Home Screen	26
Turning Off	27
Adjusting the Projected Image	28
Displaying the Test Pattern	28
Lens Adjustment Function (Focus, Zoom, Lens Shift)	28
Adjusting the focus	29
Adjusting the projection size (Zoom Adjustment)	29
Adjusting the position of the projected image (Lens Shift Adjustment)	30
Adjusting the Projector's Tilt	31
Correcting Keystone Distortion	31
Hiding the Image Temporarily	31

Adjusting the Image

Adjusting the Image	32
Selecting the Projection Quality (Color Mode)	32
Switching the Screen Between Full and Zoom (Aspect)	33
Adjusting the Sharpness	34
Adjusting Image Resolution (Image Enhancement)	35
Setting Auto Iris	36
Setting Frame Interpolation	36
Adjusting the Color	38
Adjusting the Color Temp.	38
Adjusting the RGB (Offset and Gain)	38
Adjusting Hue, Saturation, and Brightness	38
Adjusting the Gamma	40
Select and adjust the correction value	40

Adjust using the gamma adjustment graph	40
Viewing the Image at the Saved Image Quality (Memory Function)	42
Saving a Memory	42
Loading, Deleting, and Renaming a Memory	42
Useful Functions	
Enjoying 3D Images	44
Preparing to View 3D Images	44
If the 3D image cannot be viewed	44
Using 3D Glasses	45
Warnings Regarding Viewing 3D Images	45
Connecting with WirelessHD	47
Installing the WirelessHD Transmitter	47
WirelessHD Transmitter part names	48
WirelessHD Transmitter connection example and signal flow	49
Setting the WirelessHD Transmitter	54
Projecting Images	54
WirelessHD Settings Menu	56
WirelessHD Transmission Range	57
Operating the Remote Control	58
Remote Control Operating Range	58
Switching the Input and Output	58
Switching the target image	59
Switching the image source	60
Using the HDMI Link Function	61
HDMI Link Function	61
HDMI Link Settings	61
Connecting	62
Using the Projector on a Network	
Projecting Using Wired LAN	63
Selecting Wired Network Settings	63
Projecting Using Wireless LAN	65
Selecting Wireless Network Settings Manually	65

Selecting the Computer's Wireless LAN Settings	67
Selecting wireless network settings in Windows	67
Selecting wireless network settings in OS X	67
Setting Up Wireless Network Security	68
Projecting in Epson iProjection (iOS/Android)	68
Operating using a smartphone (remote control function)	69

Configuration Menu

Configuration Menu Functions	71
Configuration Menu Operations	71
Configuration Menu Table	72
Image menu	72
Signal menu	74
Settings menu	75
Extended menu	78
Network menu	82
Info menu	86
Reset menu	86

Troubleshooting

Problem Solving	87
Reading the Indicators	87
Indicator status during an error/warning	87
Indicator status during normal operation	89
When the Indicators Provide No Help	89
Check the problem	89
Problems relating to images	90
Problems when projection starts	94
Problems with the remote control	94
Problems with the control panel	94
Problems with 3D	95
Problems with HDMI	95
Problems with WirelessHD (EH-TW9400W/EH-TW8400W only)	96
Network problems	98
About Event ID	98

Maintenance

Maintenance	100
Cleaning the Parts	100
Cleaning the air filter	100
Cleaning the main unit	101
Cleaning the lens	102
Replacement Periods for Consumables	102
Air filter replacement period	102
Lamp replacement period	102
Replacing Consumables	102
Replacing the air filter	102
Replacing the lamp	103
Resetting lamp hours	105
Panel Alignment	106
Color Uniformity	108
About PJLink	110

Appendix

Optional Accessories and Consumables	111
Optional Items	111
Consumables	111
Supported Resolutions	112
PC	112
SD	112
HD	113
4K	113
3D	114
3D Input Signals MHL (via a WirelessHD Transmitter*)	115
WirelessHD Input Signal MHL*	115
Specifications	116
Appearance	119
List of Safety Symbols	120
Glossary	122
General Notes	123
Warning Labels	123
General Notice	124

Part Names and Functions

Front/Top

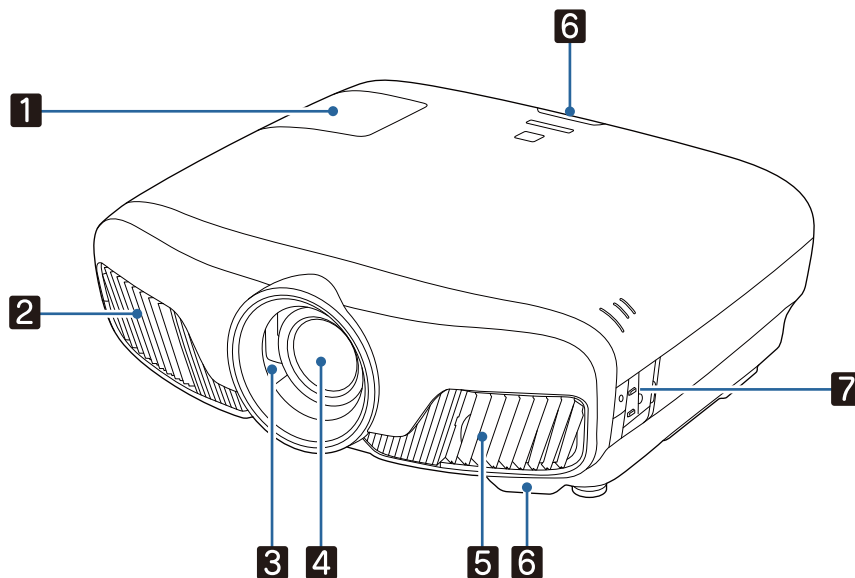







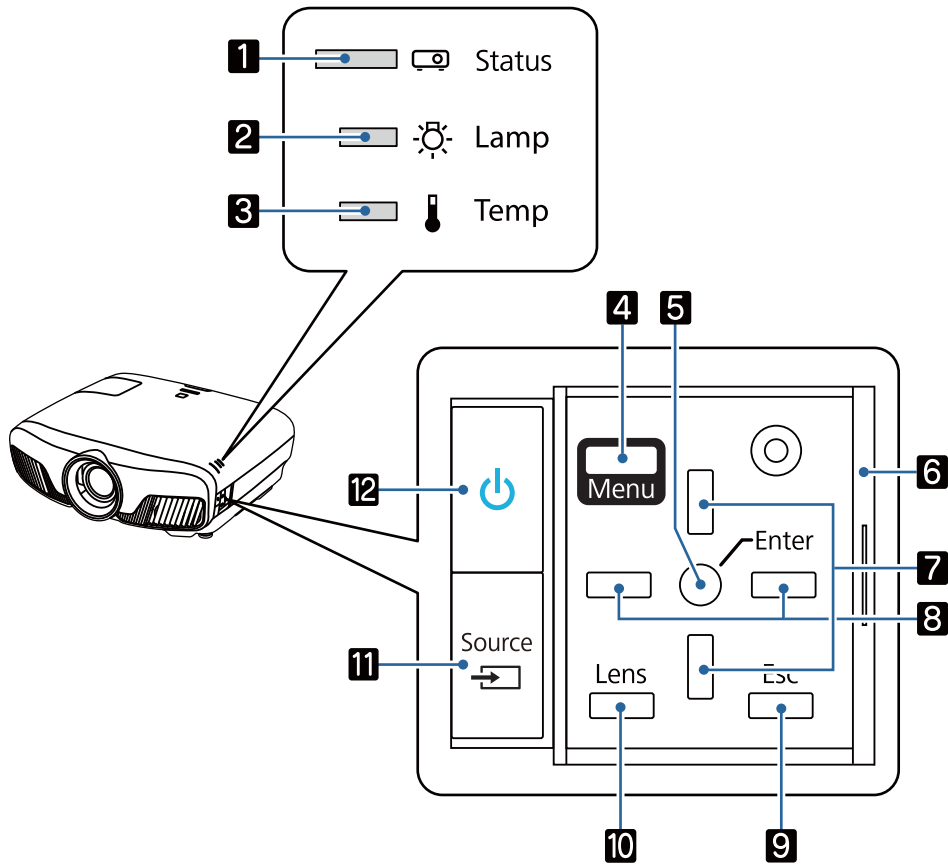

Name		Function
1	Lamp cover	Open when replacing the projector's lamp. p.103
2	Air exhaust vent	Exhaust vent for air used to cool the projector internally. <div style="border: 1px solid black; padding: 5px;"> <p> Caution</p> <p>While projecting, do not put your face or hands near the air exhaust vent, and do not place objects that may become warped or damaged by heat near the vent. Hot air from the air exhaust vent could cause burns, warping, or accidents to occur.</p> </div>
3	Lens shutter	Links to the projector's power on/off function, and automatically opens and closes the shutter. p.25
4	Lens	Images are projected from here.
5	Air intake vent	Intake vent for air used to cool the projector internally.
	Air filter cover	When replacing the air filter, open this cover and remove the air filter. p.102
6	Remote receiver	Receives signals from the remote control. p.24
7	Control panel	Operates the projector. p.7

Control Panel

When the Illumination function is set to **Off**, all indicators are off under normal projection conditions. **Extended - Operation - Illumination** p.78



Buttons/Indicators	Function
1	Flashes to indicate warm-up in progress or cool-down in progress. Shows the projector's status through a combination of other indicators lit and flashing. p.87
2	Flashes orange when it is time to replace the lamp. Shows the projector's errors through a combination of other indicators lit and flashing. p.87
3	Flashes orange if the internal temperature is too high. Shows the projector's errors through a combination of other indicators lit and flashing. p.87
4	Displays and closes the Configuration menu. On the Configuration menu, you can make adjustments and settings for Signal, Image, Input Signal, and so on. p.71
5	Selects functions and settings when a menu is displayed. p.71
6 Control panel cover	Cover for the control panel. When you want to use the control panel, grip the knob and slide the cover open.
7	Selects the adjustment value for the keystone correction and for menu items. p.31
8	Selects adjustment values for menu items. p.71
9	Returns to the previous menu level when a menu is displayed. p.71

Buttons/Indicators		Function
10	<p>Lens</p> 	<p>Changes the adjustment items for the motorized lens function.</p> <p>The adjustment items are as follows.</p> <ul style="list-style-type: none">• Focus  p.29• Zoom  p.29• Lens shift  p.30
11		<p>Changes to the image from each input port.  p.26</p>
12		<p>Turns the projector on or off.  p.25</p> <p>Lit when the projector is on. Shows the projector's errors through a combination of other indicators lit and flashing.  p.87</p>





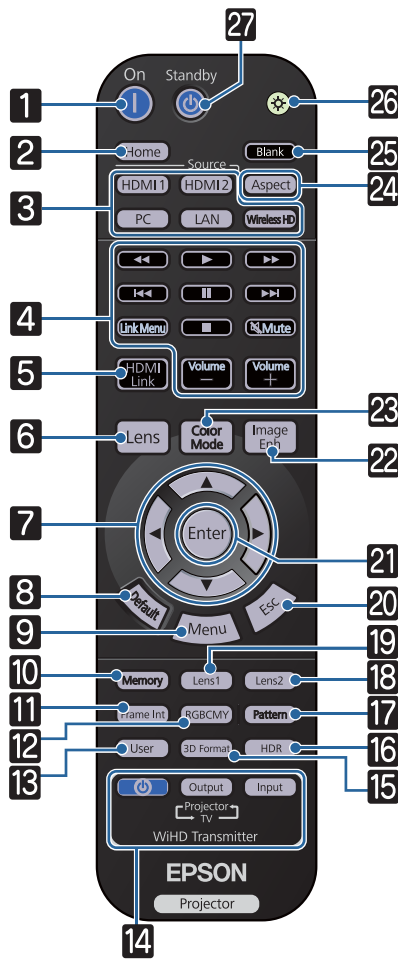



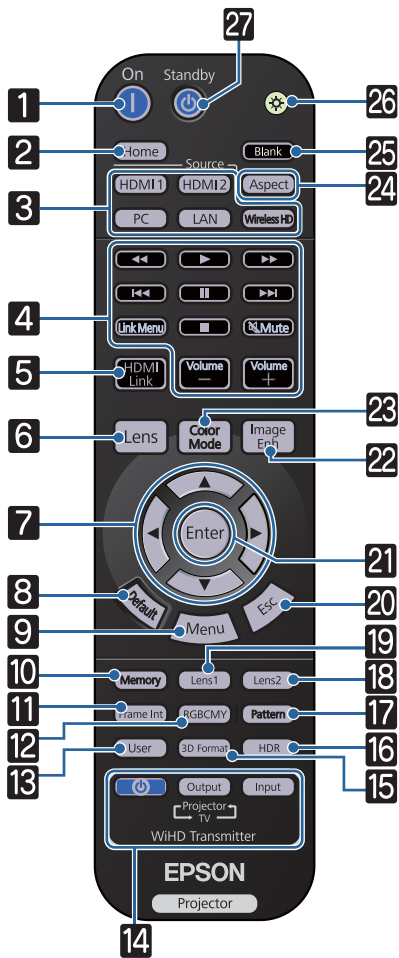





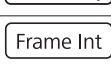

Remote Control

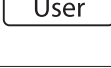
The remote control varies depending on the projector model you are using. This examples in this section are for the remote control for the EH-TW9400W/EH-TW8400W.

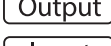
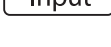

Button	Function
1 	Turns the projector on. p.25
2 	Displays and closes the Home screen. p.26
3 	Changes to the image from each input port. p.26 WirelessHD is only available for the EH-TW9400W/EH-TW8400W.
4 	Performs operations such as play, stop, and volume adjustment for connected devices that meet the HDMI CEC standards. p.61
5 	<ul style="list-style-type: none"> When HDMI Link is On Settings - HDMI Link - HDMI Link p.75 Displays the device connections list. When HDMI Link is Off Settings - HDMI Link - HDMI Link p.75 Displays the HDMI link settings menu. p.61
6 	Changes the adjustment items for the motorized lens function. The adjustment items are as follows. <ul style="list-style-type: none"> Focus p.29 Zoom p.29 Lens shift p.30



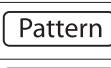
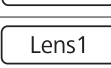

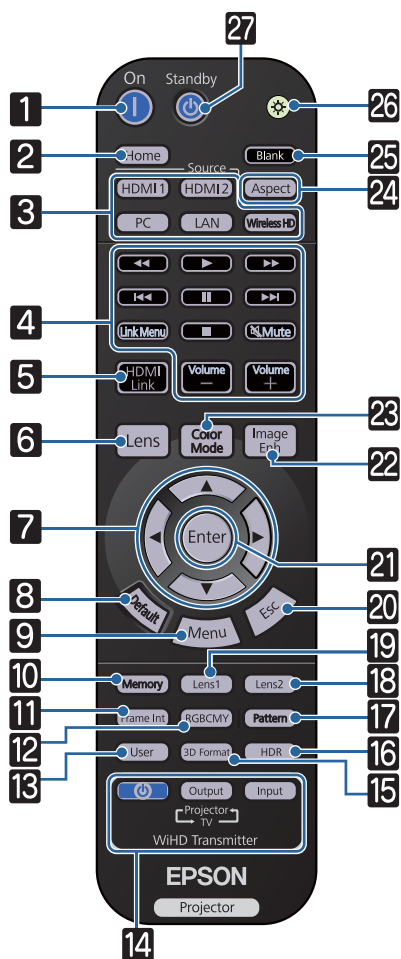



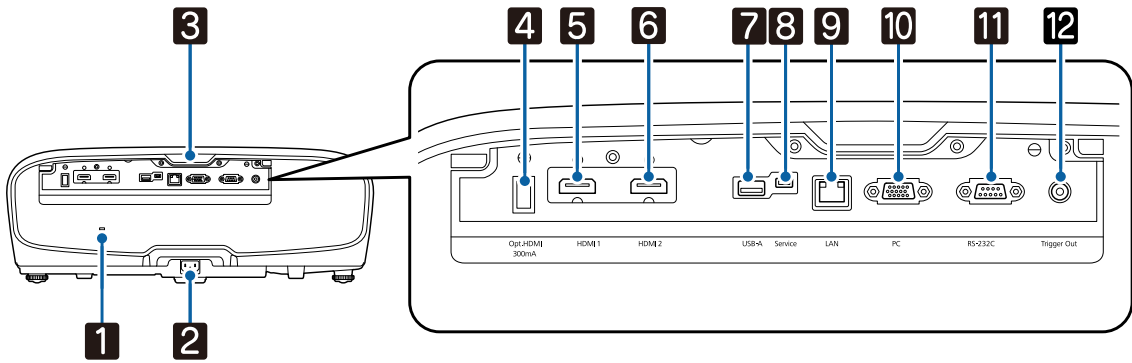

Button	Function
7	   <p>Selects menu items and adjustment values. p.71</p>
8	 <p>The adjustment value returns to its default value when pressed while the menu's adjustment screen is displayed. p.71</p>
9	 <p>Displays and closes the Configuration menu. On the Configuration menu, you can make adjustments and settings for Signal, Image, and so on. p.71</p>
10	 <p>Saves, loads, or erases a memory. p.42</p>
11	 <p>Sets the strength for Frame Interpolation. p.36</p>
12	 <p>Adjusts the hue, saturation, and brightness for each RGBCMY color. p.38</p>
13	 <p>Performs the function assigned to the user button. p.75</p>
14	   <p>(EH-TW9400W/EH-TW8400W only) This is the button for controlling the WirelessHD Transmitter. Turns on the WirelessHD Transmitter, or switches the input and output. Make sure you point the remote control at the WirelessHD Transmitter when performing operations. p.47</p>
15	 <p>Changes the 3D format. This projector supports the following 3D formats.</p> <ul style="list-style-type: none"> • Frame Packing • Side by Side • Top and Bottom p.44
16	 <p>The adjustment screen for the dynamic range is displayed. p.74</p>
17	 <p>Displays and closes the test pattern. p.28</p>
18	
19	 <p>Loads the lens position registered as Memory1 or Memory2 in the Save Lens Position. p.42</p>
20	 <p>Returns to the previous menu level when a menu is displayed. p.71</p>
21	 <p>When a menu is displayed, it accepts and enters the current selection and moves to the next level. p.71</p>



Button	Function
22	Image Enh Displays the Image Enhancement menu. p.35
23	Color Mode Changes the Color Mode . p.32
24	Aspect Selects the aspect mode according to the input signal. p.33
25	Blank Temporarily stops projection. To turn the image back on, press this button again. p.31
26	 The remote control buttons light up for approximately 10 seconds. This is useful when operating the remote control in the dark.
27	Standby Turns the projector off. p.27

Rear



Name		Function
1	Security slot ()	The security slot compatible with the MicroSaver security system manufactured by Kensington. For more details, visit the homepage of Kensington at http://www.kensington.com/ .
2	Power inlet	Connect the power cord.  p.25
3	Remote receiver	Receives signals from the remote control.  p.24
4	Opt.HDMI port	Connects the power supply port for the optical HDMI cable. However, connection for all the devices is not guaranteed. Make sure to check if your device works beforehand.
5	HDMI1 port	Connects HDMI compatible video equipment and computers.  p.19
6	HDMI2 port	HDMI1/HDMI2 ports support HDCP 2.2.
7	USB-A port	Connects the optional Wireless LAN unit. It is also used when updating the firmware.  p.21
8	Service port	Service port. This is not normally used.
9	LAN port	Connects a LAN cable to connect to a network.  p.21
10	PC port	Connects to the RGB output port on a computer.  p.20
11	RS-232C port	When controlling the projector, connect the projector to a computer with an RS-232C cable. This port is for control use and should not normally be used.
12	Trigger Out port	Connects with external devices such as motorized screens.  p.20

Base

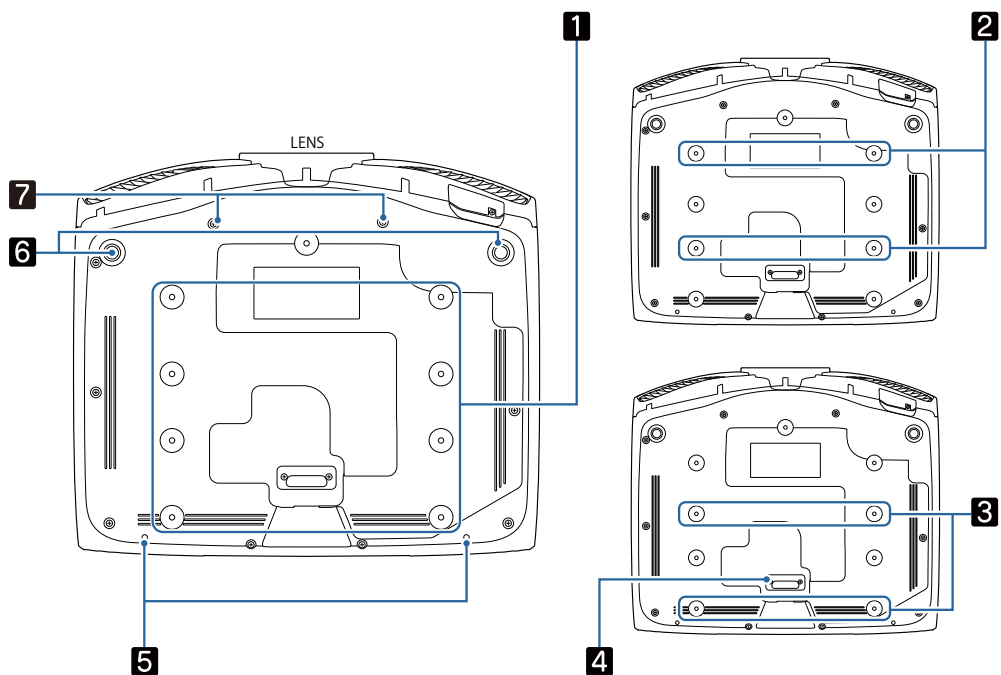

Name		Function
1	Ceiling mount fixing points	Attaches the optional ceiling mount here when suspending the projector from a ceiling. p.111 Use the four ceiling mount fixing points for 2 or 3 depending on the installation environment. Use the 3 fixing points when installing next to a wall in a small room.
2		
3		
4	Rear foot	Remove this when using the 3 ceiling mount fixing points.
5	Cable cover fixing screw	Screw holes for attaching the cable cover.
6	Front adjustable foot	When set up on a surface such as a table, extend the foot to adjust horizontal tilt. p.31
7	Screw holes for anamorphic lens	Screw holes for attaching the anamorphic lens.

Installing

Projected Image and Position of Projector

Install the projector as follows.

■ Installing in parallel with the screen

If the projector is installed at an angle to the screen, keystone distortion occurs in the projected image. Adjust the projector's position so that it is installed in parallel with the screen.

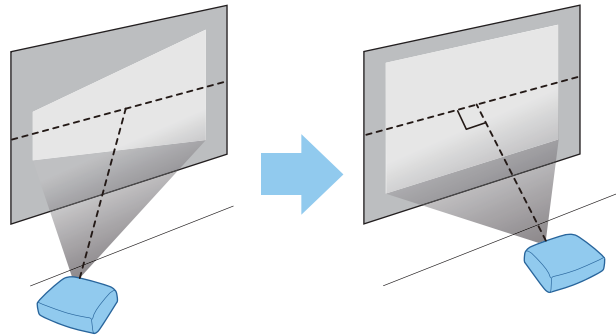

If the projector cannot be installed in front of the screen, you can adjust the position of the image by using lens shift. [p.30](#)

■ Installing the projector horizontally by adjusting the height of either side

If the projector is tilted, the projected image is also tilted.

Install the projector horizontally so that both sides are at the same height.

If the projector cannot be installed horizontally, you can adjust the projector's tilt with the front foot. [p.31](#)

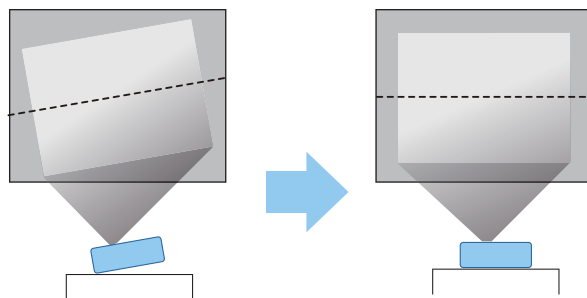

Various Setting Methods

Warning

- A special method of installation is required when suspending the projector from a ceiling (ceiling mount). If it is not installed correctly, it could fall, causing an accident and injury.
- If you use adhesives, lubricants, or oil on the ceiling mount fixing points to prevent screws from loosening, or if you use items such as lubricants or oils on the projector, the outer projector case may crack, which causes it to fall from its ceiling mount. This could cause serious injury to anyone under the projector and also damage the projector.
- Do not set up the projector in locations exposed to high humidity and dust, such as on a kitchen counter, in the kitchen, or near a humidifier, or in locations exposed to oil smoke or steam. Doing so could cause fire or electric shock. In addition, the oil content could cause the projector's outer case to deteriorate and could cause the projector to fall off from the ceiling where it is suspended.
- Do not install it on an unstable shelf or in a place out of load range. Otherwise, it could fall or topple causing an accident and injury.
- When installing it in a high position such as on a shelf, take measures against falling by using wires to ensure the safety in an emergency, such as an earthquake, and prevent accidents. If it is not installed correctly, it could fall causing an accident and injury.
- Do not block the air intake vent and air exhaust vent of the projector. Blocking its air intake vent and air exhaust vent may trap heat inside causing fire.

Attention

- Do not use the projector installed vertically. Doing so could cause a malfunction.
- Clean the air filter once every three months. Clean it more often if the environment is particularly dusty.

 [p.100](#)

Placing on a table and projecting

You can install the projector on a table in your living room or on a low shelf to project images.

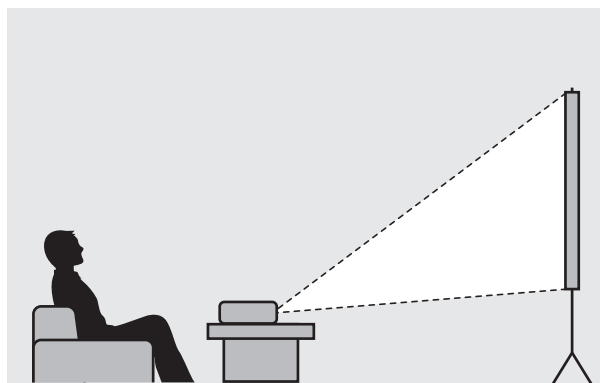

■ Suspending from the ceiling and projecting

You can suspend the projector from the ceiling with the optional ceiling mount to project images.

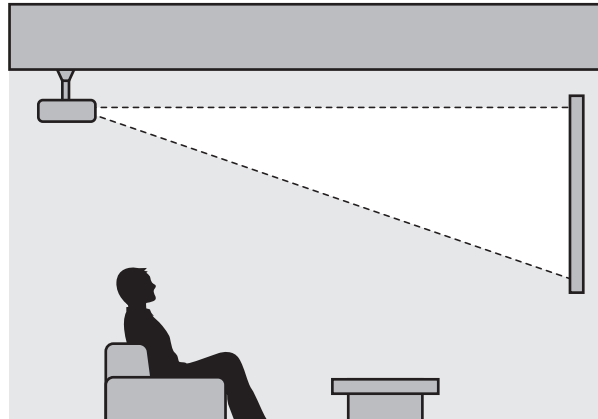

When suspending from the ceiling and projecting, set **Projection** to **Front/Ceiling** or **Rear/Ceiling**. **Extended - Projection** p.78

Projection Distance and Lens Shift Maximum Values

The size of the projection increases as the projector is moved away from the screen.

Use the table below to setup the projector at the optimum position from the screen. The values given here are for your reference only.

The maximum lens shift adjustment values are shown in the following table.



The projected image becomes smaller after correcting distortion. Increase the projection distance to fit the projected image to the screen size.

When adjusting the projection position vertically in lens shift

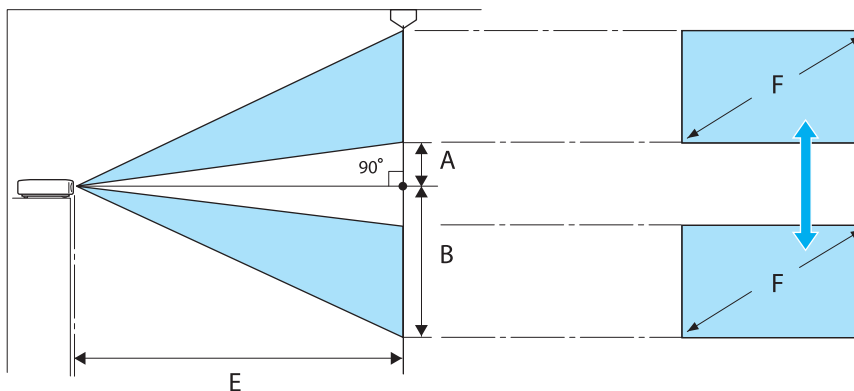

- A : Distance from the center of the lens to the bottom edge of the projected image (when lens shift is raised to its highest level)
- B : Distance from the center of the lens to the bottom edge of the projected image (when lens shift is lowered to its lowest level)
- E : Projection distance from the projector to the screen
- F : Size of the projected image

When adjusting the projection position horizontally in lens shift

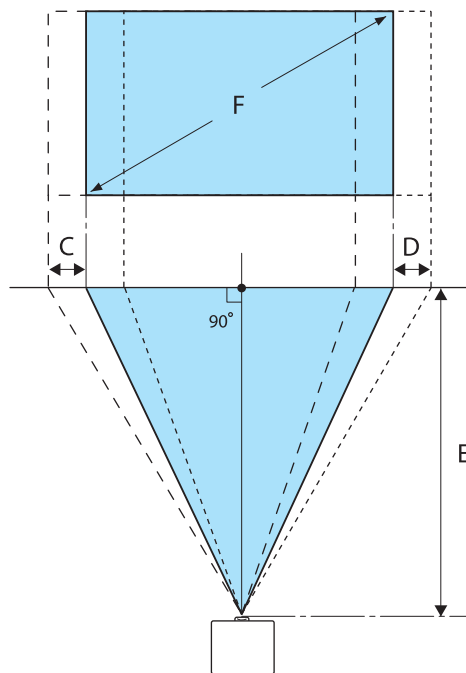

- C : Lens center movement distance when the projector is moved (when lens shift is set to maximum left)
- D : Lens center movement distance when the projector is moved (when lens shift is set to maximum right)
- E : Projection distance from the projector to the screen
- F : Size of the projected image

Unit: cm

16:9 Screen Size		Projection Distance (E)		Lens Shift Maximum Values*		
F	W x H	Minimum (Wide)	Maximum (Tele)	Distance (A)	Distance (B)	Distance (C, D)
50"	111 x 62	148	313	29	91	52
60"	133 x 75	178	376	35	109	63
80"	177 x 100	239	503	46	146	83
100"	221 x 125	300	630	58	182	104
150"	332 x 187	452	947	86	273	156
200"	443 x 249	604	1264	115	364	209
250"	553 x 311	756	1582	144	455	261
300"	664 x 374	908	1899	173	547	313

* Vertical and horizontal lens shift cannot both be set to their maximum values. 🖱️ p.30

Installation example (with 16:9 screen size and 100")

Side view

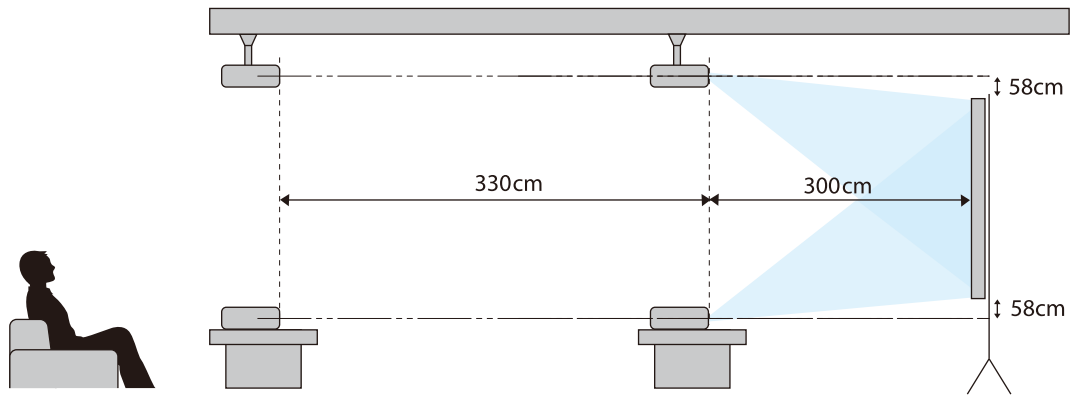

Overhead view

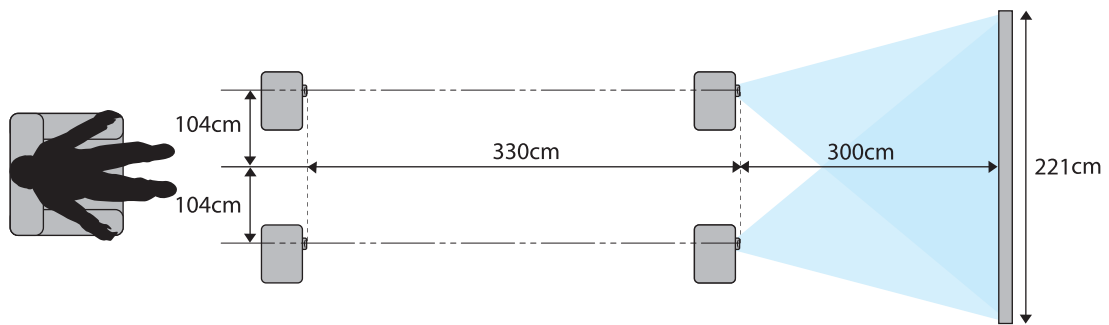

Connecting a Device

Attention

- Make cable connections before connecting to a power outlet.
- Check the shape of the cable's connector and the shape of the port, and then connect. If you force a connector of a different shape into the port, it could cause damage and a malfunction to occur.

Removing the Terminal Cover

Depending on the model you are using, the projector may have a terminal cover for the connector section on the rear to improve the overall appearance of the projector. Remove the terminal cover before connecting any cables.

There are gaps at the bottom of the terminal cover that allow you to pull the cover forward and lift it from the grooves at the top.

When reattaching, first insert the protruding sections into the grooves at the top.

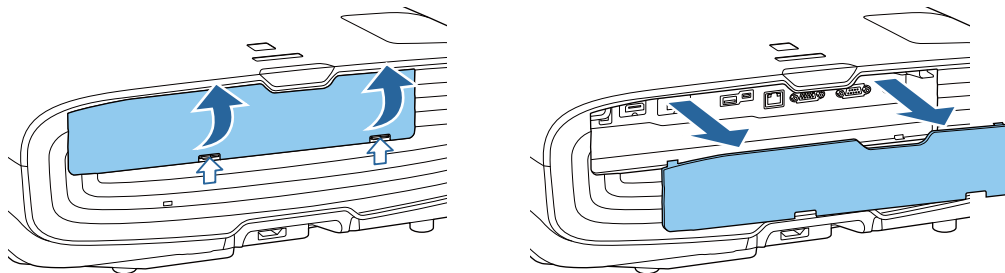

Connecting Video Equipment

To project images from DVD/Blu-ray players, connect to the projector using one of the following methods.

When using a commercially available HDMI cable

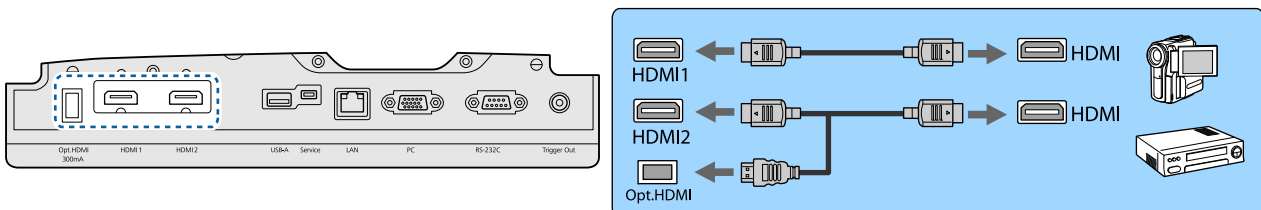

- To display signals in the 18 Gbps transmission band, such as 4k60p/4:4:4, use a premium HDMI cable. If you use a cable that does not support it, images may not be displayed properly. If you experience any trouble displaying images at 18 Gbps, change the EDID setting to **Normal**. **Signal-Advanced-EDID p.74**
- When using the power supply port for an optical HDMI cable, connect it to the Opt.HDMI port.
- HDMI1/HDMI2 ports support HDCP 2.2.
- This projector does not have a built-in speaker. Connect the projector to your AV system to listen to audio from connected equipment.

Connecting a Computer

To project images from a computer, connect the computer using one of the following methods.

When using a commercially available computer cable

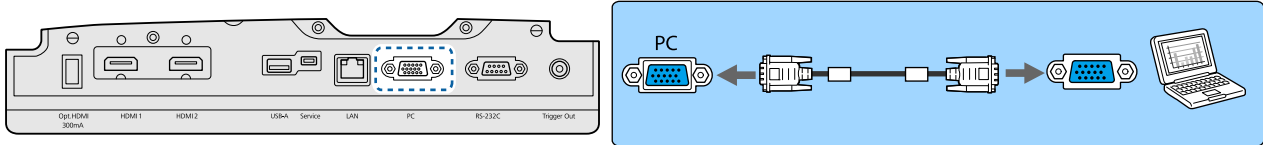

When using a commercially available HDMI cable

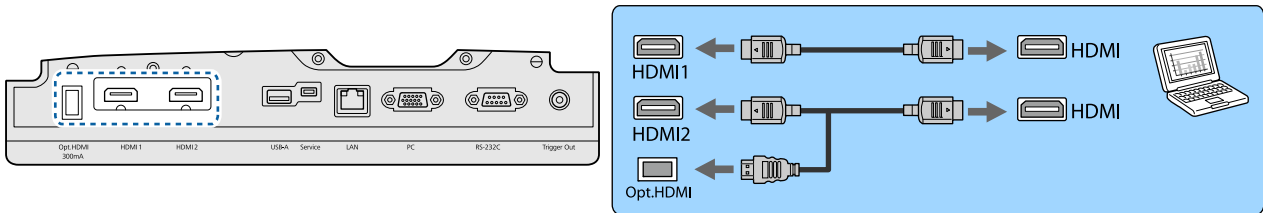

Connecting External Equipment

Connecting to the Trigger Out port

To connect external devices such as motorized screens, connect a mini-jack stereo cable (3.5 mm) to the Trigger Out port. When set to on, a signal (12 V DC) is output from this port to communicate the projector's status (On or Off) to connected devices such as electric screens.

To use the **Trigger Out** port, set **Trigger Out** to **Power** (EH-TW9400W/EH-TW9400 only) or **On** (EH-TW8400W/EH-TW8400 only). [Extended - Operation - Trigger Out p.78](#)

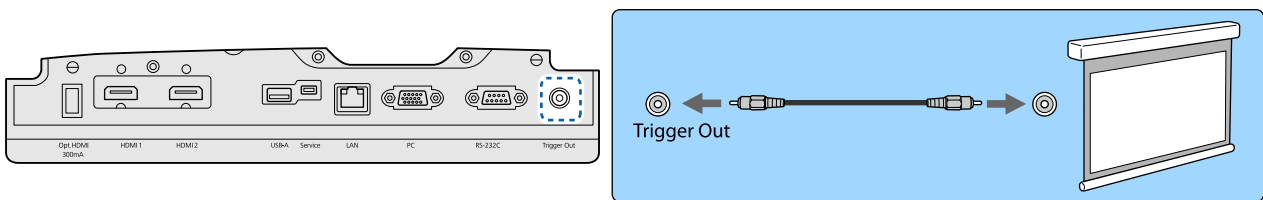

Connecting WirelessHD devices (EH-TW9400W/EH-TW8400W only)

The projector receives transmissions from the WirelessHD Transmitter, and projects the images. [p.47](#)

Change the projected image by pressing the button on the remote control or the button on the control panel.

- When receiving WirelessHD images, make sure **WirelessHD** is set to **On**. [Settings - WirelessHD - WirelessHD p.75](#)
- You can change which device is displayed by selecting a device from **Device Connections** in **HDMI Link**. [Settings-HDMI Link-Device Connections p.75](#)

Connecting Smartphones or Tablets

You can connect MHL compatible smartphones or tablets to the WirelessHD Transmitter. Use an MHL compatible cable to connect the micro USB port of smartphones and tablets to the HDMI4 port on the WirelessHD Transmitter.

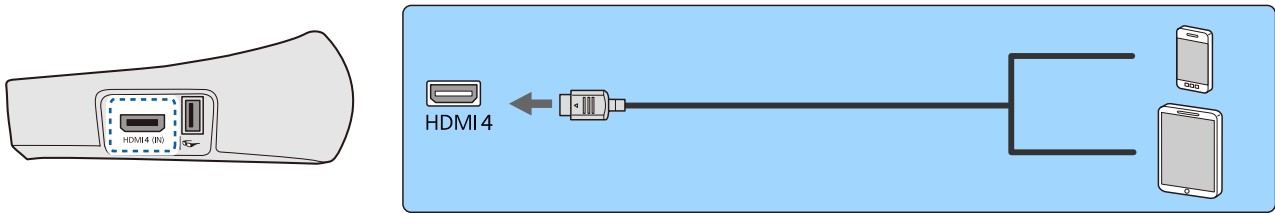

You can operate smartphones or tablets from the projector remote control. You can also view video and listen to music while charging a smartphone or tablet.

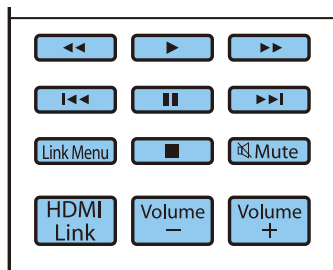

Attention

- Make sure the connection cable supports the MHL standards. During charging, the smartphone or tablet could generate heat, cause a liquid leak, explode or generate other conditions that could result in a fire.
- When a connection is made using an MHL-HDMI conversion adapter, it may not be possible to charge or control the device from the remote control.



Some devices use more power during video playback than what is supplied and will therefore not enable charging during video playback or other operations.

Connecting to the LAN port

Connect to a network router, a hub, and so on, with a 100BASE-TX or 10BASE-T LAN cable.

You can operate the projector or check its status over a network from a computer or a smart device.

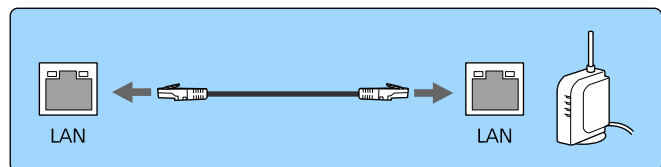
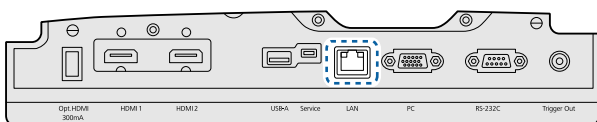

To prevent malfunctions, use a category 5 or higher shielded LAN cable.

Attaching the Wireless LAN unit

To use the wireless LAN function, attach an optional Wireless LAN unit (ELPAP10).

Connect the Wireless LAN unit to the USB port.

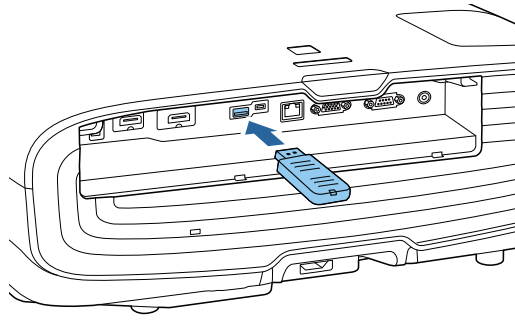

You can use one of the following methods to project over wireless LAN. For more details, see the download page.

- **Projecting four screens simultaneously**

When using Epson iProjection (Windows/Mac), you can display up to four separate screens from the projector from up to 50 computers connected to the network.

Download Epson iProjection from the following Web site.

<http://www.epson.com>

- **Projecting images from a mobile terminal via a network**

By installing Epson iProjection (iOS/Android) on a smartphone or tablet, you can wirelessly project data on your device. [p.68](#)



- When not using the wireless LAN function with the Wireless LAN unit kept inserted, set **Wireless LAN Power** to **Off**. This can prevent unauthorized access from outsiders. [p.82](#)
- When using Epson iProjection in **Quick** connection mode, we recommend making security settings. [p.84](#)

Connecting an HDMI Cable Clamp

If the HDMI cable is thick and hangs down, make sure you secure it to the cable holder with an HDMI clamp so that the cable's weight does not disconnect it from the port.

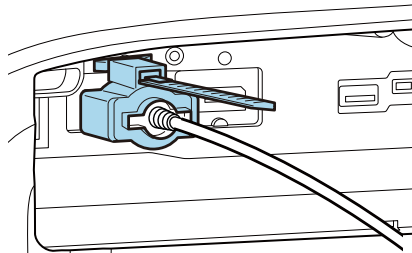

Preparing the Remote Control

Installing the Remote Control Batteries

Attention

- Check the positions of the (+) and (-) marks inside the battery holder to ensure the batteries are inserted the correct way.
- You cannot use other batteries except for the AA size manganese or alkaline.

- 1** Remove the battery cover.
While pushing the battery compartment cover catch, lift the cover up.

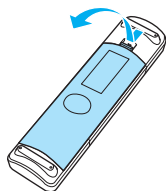

- 2** Replace the old batteries with new batteries.
Check the polarity of the batteries (+) and (-) before installing.

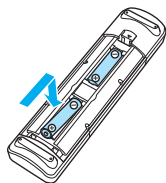

- 3** Reattach the battery cover.
Press the cover until it clicks into place.

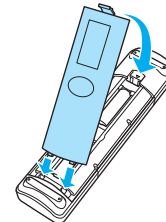

 If delays in the responsiveness of the remote control occur or if it does not operate, it probably means that the batteries are becoming flat. When this happens, replace them with new batteries. Have two AA size manganese or alkaline batteries ready.

Remote Control Operating Range

The operation range for the WirelessHD Transmitter differs. [p.58](#)

Operating range (left to right)

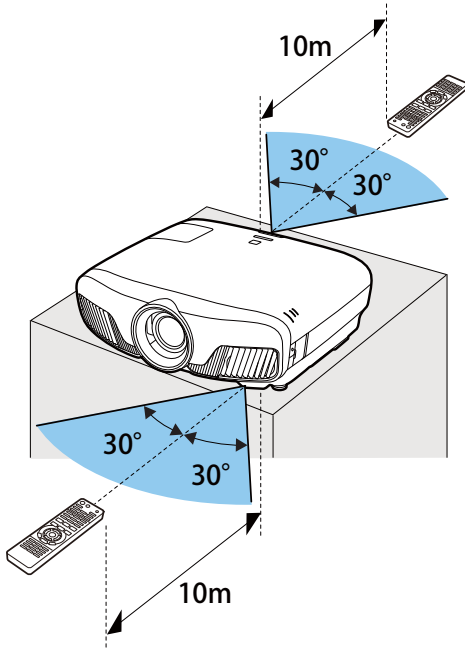

Operating range (top to bottom)

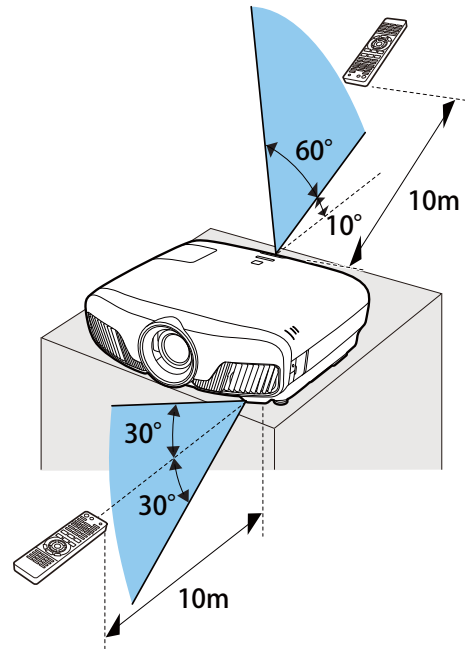

Projecting Images

Turning On the Projector



1 Connect the equipment to the projector.

2 Connect using the power cord supplied.

The projector's power indicator turns blue. This indicates that the projector is receiving power, but is not yet turned on (it is in standby mode).

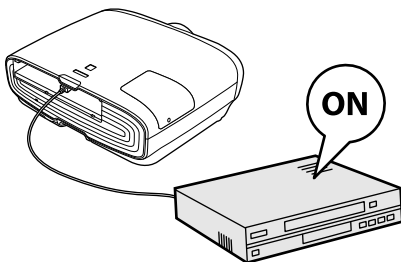
3 Turn on the connected equipment.



4 Press the  button on the remote control or the  button on the control panel to turn on the projector.

Remote control

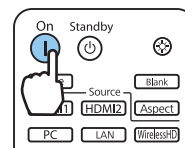

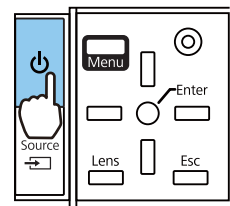

Control panel



The lens shutter opens, and projection starts.



The  (operation indicator) flashes blue as the projector warms up. Once the projector is warmed up, the operation indicator stops flashing and turns blue.

 When **Direct Power On** is set to **On**, you can start projecting by simply connecting the power cord to the projector without having to press any buttons.  **Extended - Operation - Direct Power On** [p.78](#)

Warning

- Do not look into the lens during projection. The powerful light emitted could cause damage to eyesight. Pay close attention to how your child behaves.
- Do not stand in front of the lens during projection. Clothes could be damaged due to the high temperature.



- This projector provides a Child Lock function to prevent children from accidentally turning the power on and a Control Panel Lock function to prevent accidental operations and so on.  **Settings - Lock Setting - Child Lock/Control Panel Lock** [p.75](#)
- This projector provides an Auto Setup function to automatically select the optimum settings when the input signal for the connected computer image changes.  **Signal - Auto Setup** [p.74](#)
- When using at an altitude of 1500 m or more, set **High Altitude Mode** to **On**.  **Extended - Operation - High Altitude Mode** [p.78](#)

■ If the target image is not projected

If the image is not projected, you can change the source using one of the following methods.

Remote control

Press the button for the target port.

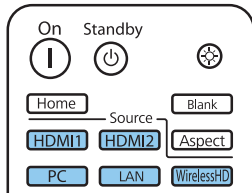

Control panel

Press the button and select the target port.

Press the button to confirm the selection.

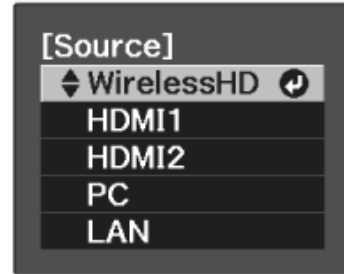

Using the Home Screen

The Home screen feature allows you to easily select an image source and access useful functions.

Press the button on the remote control to display the Home screen.

Under the following conditions, the Home screen is displayed automatically when the projector is turned on.

- **Home Screen Auto Disp.** is set to **On**. **Extended - Home Screen - Home Screen Auto Disp.** p.78
- There are no signals from any sources.

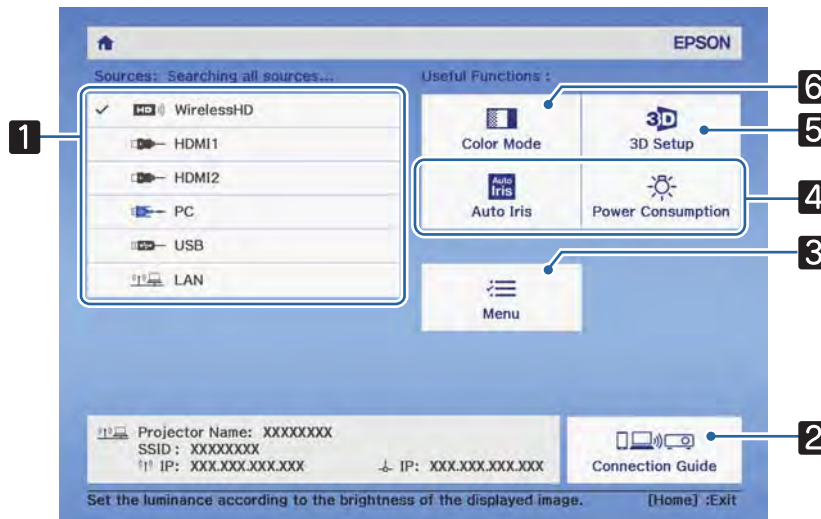



1	Selects the source you want to project.
2	Connection Guide is displayed.
3	Displays the Configuration menu. p.71
4	Performs menu options assigned to Home Screen in the Extended menu. Extended - Home Screen p.78
5	Sets the 3D function. Signal - 3D Setup p.74
6	Selects the Color Mode . p.32



The Home screen disappears after 10 minutes of inactivity.

Turning Off

1 Turn off the connected equipment.

2 Press the  button on the remote control or the  button on the control panel.

Remote control

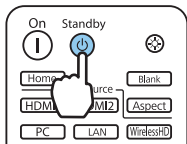

Control panel

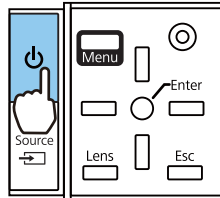

A confirmation message is displayed.

3 Press the  button again.

Power Off?

Yes : Press  button

No : Press any other button

Projection ends, and the lens shutter closes automatically.

The operation indicator flashes and the projector begins to cool down.

4 Wait until cool-down is complete.

When cool-down is complete, the operation indicator stops flashing.

5 Disconnect the power cord.

Adjusting the Projected Image

Displaying the Test Pattern

When adjusting the zoom/focus or the projection position just after setting up the projector, you can display a test pattern instead of connecting video equipment.

Press the **Pattern** button on the remote control to display the test pattern. The standard for horizontal lines at the top and bottom uses 2.40:1 CinemaScope.

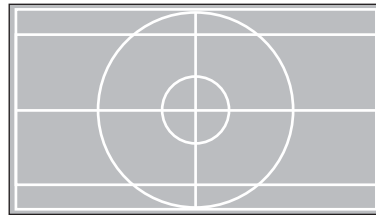
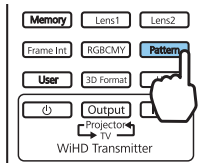

When you select Color Isolation while projecting images, the color selected from R (red), G (green), or B (blue) is projected (EH-TW9400W/EH-TW9400 only).

Press the **Pattern** button again to end the test pattern display.

Lens Adjustment Function (Focus, Zoom, Lens Shift)

To adjust the focus, zoom, or lens shift, press the **Lens** button on the remote control or the **Lens** button on the control panel, and then select the item you want to adjust.

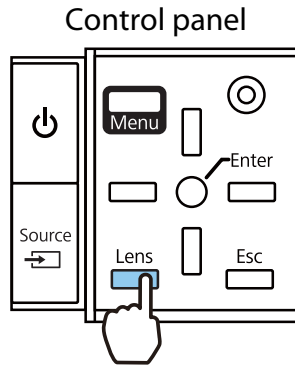
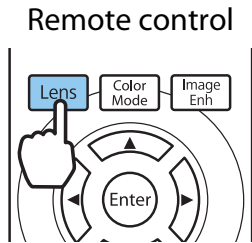

The adjustment items switch as shown in the following table.

1	Focus adjustment	Adjust Focus is displayed on the screen. Adjusts the focus of the projected image. p.29
2	Zoom adjustment	Adjust Zoom is displayed on the screen. Adjusts the size of the projected image. p.29
3	Lens shift adjustment	Adjust Lens Shift is displayed on the screen. Adjusts the position of the projected image. p.30

To finish making adjustments, press the **Lens** button in Lens shift adjustment.

You can register the results of lens adjustment to the memory (Save Lens Position). You can load the lens position that you registered from the remote control or the Configuration menu.

■ Adjusting the focus

1 Press the **Lens** button on the remote control.
Adjust Focus is displayed on the screen.

2 Press the **◀▶** buttons to adjust the focus.

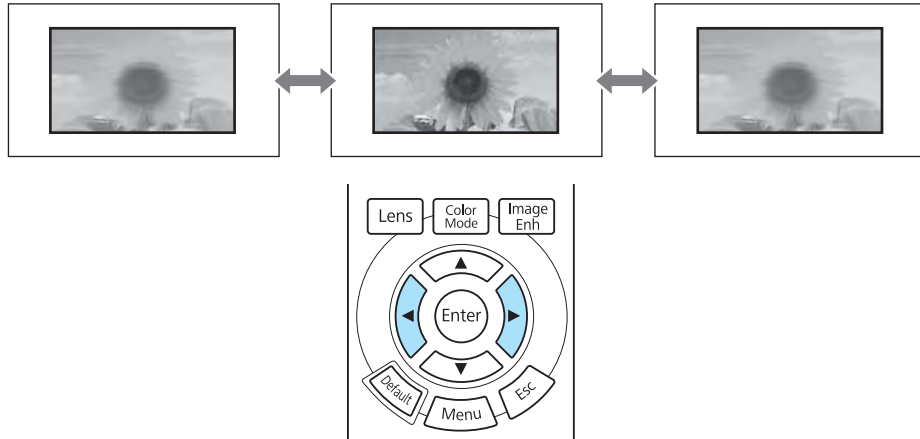

3 Press the **Lens** button three times to finish making adjustments.

■ Adjusting the projection size (Zoom Adjustment)

1 Press the **Lens** button on the remote control twice.
Adjust Zoom is displayed on the screen.

2 Press the **◀▶** buttons to adjust the size of the projected screen.

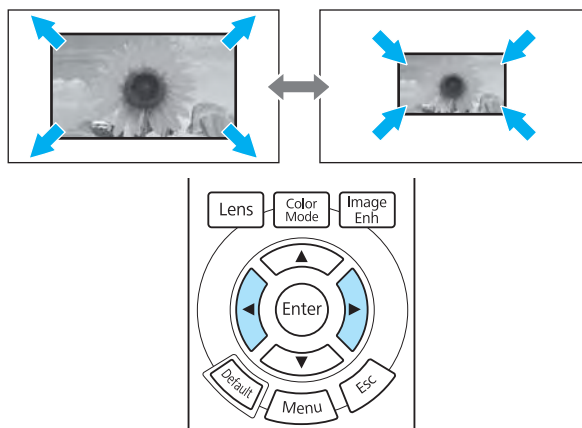





3 Press the **Lens** button twice to finish the adjustment.

Adjusting the position of the projected image (Lens Shift Adjustment)

If the projector cannot be installed directly in front of the screen, you can adjust the position of the image by using lens shift.

1 Press the **Lens** button on the remote control three times.

Adjust Lens Shift is displayed on the screen.

2 Use the     buttons to adjust the position of the image.

You can move the image within the range indicated by the dotted line in the following figure.





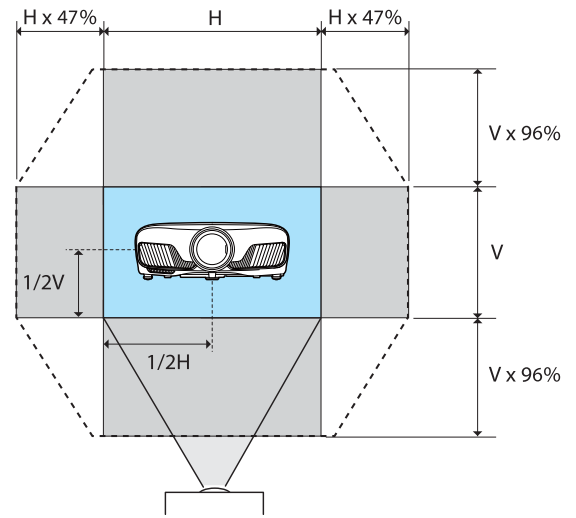

To move the lens position back to the center, hold the **Lens** button for at least three seconds.



3 Press the **Lens** button to finish the adjustment.



When the following message is displayed when you change to **Adjust Lens Shift**, the image moves in the opposite direction to the direction pressed with the     buttons. When **Front/Ceiling** or **Rear/Ceiling** is set for **Projection**, select **Inverted**.  **Extended - Projection** [p.78](#)

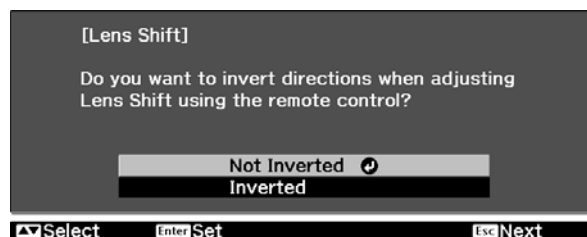

Caution

- When transporting the projector, set the lens position to the center. If you transport the projector when the lens is not in the central position, the lens shift mechanism could be damaged.
- Do not put your finger in the moving parts of the projector's lens. Otherwise an injury could occur.



- When you cannot install the projector directly in front of the screen, it is recommended that you use lens shift to adjust the projection position.
- If finely adjusting the lens shift does not work, press briefly on the arrow buttons to perform minute adjustments while viewing the image.

Adjusting the Projector's Tilt

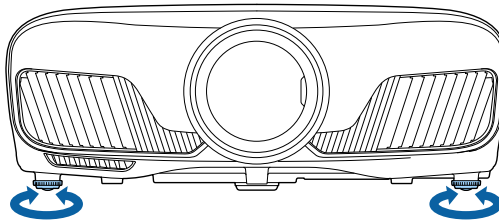

If the projected image is horizontally tilted (the left and right sides of the projected image are at different heights) when the projector is setup on a table, adjust the front foot so that both sides are level with each other.





Correcting Keystone Distortion

You can use the  buttons on the control panel to correct keystone distortion.

Open the control panel cover at the side to operate the control panel.  [p.7](#)

Press the  or  buttons to display the adjustment gauges.

When the gauges are displayed, press the  and  buttons to perform vertical correction.

When the top or bottom is too wide

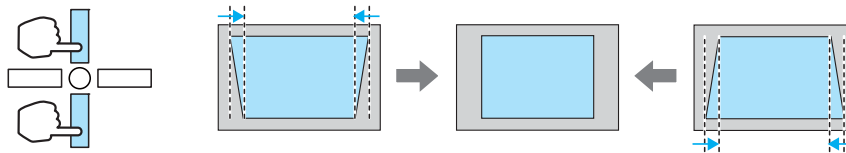

- When you correct keystone distortion, the projected image may be reduced. Increase the projection distance to fit the projected image to the screen size.
- You can make keystone settings from the Configuration menu.  **Settings - Keystone** [p.75](#)
- You can make effective corrections within a projection angle of 30° top to bottom.

Hiding the Image Temporarily

You can use this to temporarily hide the image on the screen.

Press the  button to show or hide the image.

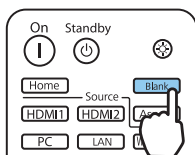

For movies, because the movie continues to play even when it is hidden, you cannot return to the point at which you hid the image using the  button.



Adjusting the Image

Selecting the Projection Quality (Color Mode)

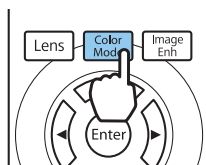

You can obtain the optimum image quality to suit your surroundings when projecting. The brightness of the image varies depending on the mode selected.

1 Press the  button.



- You can make settings from the Configuration menu.  **Image - Color Mode** p.72
-  If you press the button, you can also make settings from the Home screen.  p.26

2 Select **Color Mode**.

Use the   buttons to select a mode, and then press the  button to confirm the selection.



Choices when projecting 2D images

Mode	Application
Dynamic	This is the brightest mode. Best for prioritizing brightness.
Bright Cinema	Best for projecting vivid images.
Natural	Best for faithfully reproducing the color of the source image. We recommend selecting this mode when performing color adjustment for the image.  p.38
Cinema	Best for enjoying content such as movies.
Digital Cinema	Projects images in the Digital Cinema color space. Best for prioritizing colors.

Choices when projecting 3D images

Mode	Application
3D Dynamic	A dedicated 3D mode best for prioritizing brightness.
3D Cinema	A dedicated 3D mode best for enjoying content such as movies.

Switching the Screen Between Full and Zoom (Aspect)

You can change the input signal's type, aspect ratio, and resolution to match the **Aspect** of the projected image.



The available settings vary depending on the image signal currently being projected.

 Note that using the aspect ratio function of the projector to reduce, enlarge, or split the projected image for commercial purposes or for public viewing may infringe upon the rights of the copyright holder of that image based on copyright law.

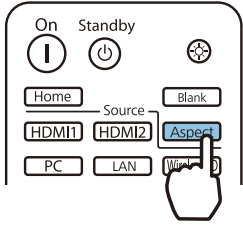
1 Press the **Aspect** button.



 You can make settings from the Configuration menu. **Signal - Aspect p.74**

2 Use the   buttons to select the setting name, and then press the **Enter** button to confirm the selection.



 You may not be able to change the **Aspect** depending on the input signal.

By normally selecting **Auto**, the optimum aspect is used to display the input signal. Change the setting if you want to use a different aspect.

The table below shows the image projected on a 16:9 screen.

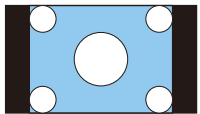
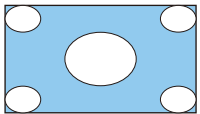
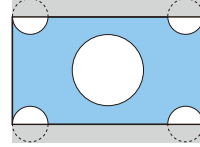
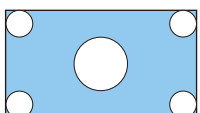
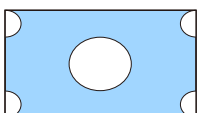
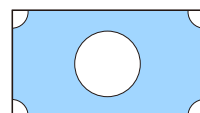
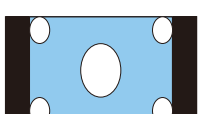
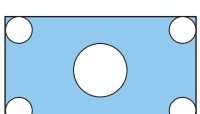
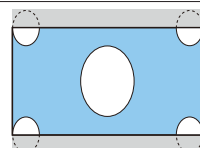
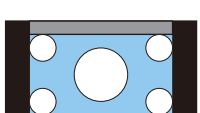
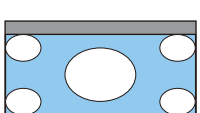
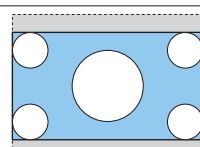
Input Image	Setting Name		
	Normal	Full	Zoom
4:3 Images			
16:9 Images*1			
Images Recorded Using Squeeze			
Letterbox Images*2			

Input Image	Setting Name		
	Normal	Full	Zoom
Notes	Matches the vertical size of the projection panel. The aspect ratio differs depending on the input image.	Uses the entire projection panel. The aspect ratio differs depending on the input resolution.	Retains the aspect ratio of the input signal, and matches the horizontal size of the projection panel. The top and bottom of the image may be truncated.

*1 The full and zoom used for 16:9 signal input cannot be used for 4K and 3D signals, as well as for the PC image signal.

*2 The letterbox image used in this explanation is a 4:3 aspect ratio image displayed in 16:9 with black margins at the top and bottom for subtitle placement. The margins at the top and bottom of the screen image are used for subtitles.

For EH-TW9400W/EH-TW9400, you can also set **Anamorphic Wide** and **Horiz. Squeeze**.

Set **Anamorphic Wide** and attach a commercially available anamorphic lens to enjoy DVDs, Blu-rays, and so on of images recorded at Cinema Scope size.

Horiz. Squeeze stretches the horizontal aspect of the input signal. This allows you to project across the full width of the screen when using a commercially available anamorphic lens.



- If **Anamorphic Wide** is selected when **Overscan** is set, the image may be truncated. Set **Overscan** to **Off**. **Signal-Overscan** p.74
- When projecting 3D images in **Anamorphic Wide**, only 1080p/24 Hz/frame packing signals are supported.
- When a 4K image signal is being input, you can only select **Normal**, **Anamorphic Wide**, and **Horiz. Squeeze**.

Adjusting the Sharpness

You can make the image clearer.

The following shows the setting items and procedures.

Standard	Enhances the outlines for the projected image overall. When you adjust Standard , the adjustment values for Thin Line Enhancement and Thick Line Enhancement are also adjusted.
Thin Line Enhancement	Details such as hair and patterns on clothing are enhanced.
Thick Line Enhancement	Rough parts such as outlines for entire subjects or the background are enhanced, making the overall image clearer.

1 Press the **Menu** button.

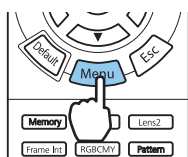





The Configuration menu is displayed.

2 Select **Image - Sharpness**.

The **Sharpness** adjustment screen is displayed.

3

Use the   buttons to select the item, and then use the   buttons to make the adjustments.

The image is enhanced when moved to the right (positive) and softer when moved to the left (negative).



Press the  button to return the adjustments to their default values.

4

Press the  button to exit the menu.

Adjusting Image Resolution (Image Enhancement)



You can adjust the resolution of the image using the Image Enhancement function.

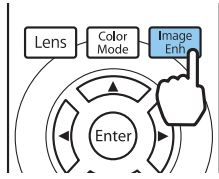

The following content can be adjusted.

4K Enhancement	4K Enhancement is a function that projects an image at a doubled resolution by diagonally shifting 1 pixel in increments of 0.5 pixels. A high-resolution image signal is projected in fine detail.
Image Preset Mode	Select the settings prepared in advance as the settings for Noise Reduction , MPEG Noise Reduction , Super-resolution , and Detail Enhancement .
Noise Reduction	(This can be specified only when Image Processing is set to Fine .) Smooths out rough images.
MPEG Noise Reduction	(This can be specified only when Image Processing is set to Fine .) You can reduce dot and block noise that occurs in outlines when projecting MPEG movies.
Super-resolution	Fine Line Adjust: Enhances the contrast and the outlines of complicated images. Soft Focus Detail: Enhances the contrast and the outlines for smooth backgrounds.
Detail Enhancement	Enhances the contrast in an image to create a more emphatic texture and material feel. Strength: The larger the value, the stronger the contrast. Range: The larger the value, the wider the range of detail enhancement becomes.



1 Press the  button.



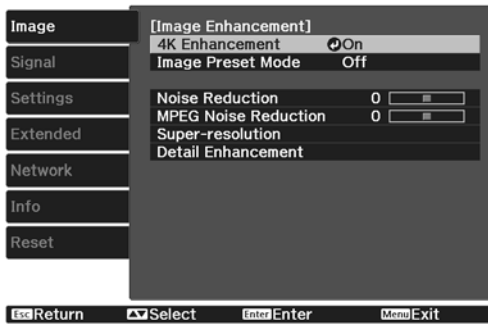

 You can make settings from the Configuration menu.  **Image - Image Enhancement** p.72

2 Use the   buttons to select the item you want to adjust, and then press the  button to confirm the selection.



3 Use the   buttons to make adjustments.

Press the  button to adjust another item.

Press the  button to return the adjustments to their default values.



4 Press the  button to exit the menu.

Setting Auto Iris

By automatically setting the luminance according to the displayed image, you can enjoy deep and rich images. You can select the luminance adjustment tracking for changes in brightness in the displayed image from **Normal** to **High Speed**.







Press the  button to display menus in the following order.

Image - Auto Iris

Use the   buttons to select the item, and then press the  button to confirm the selection.

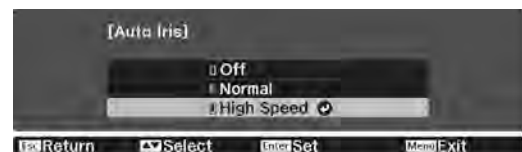

 Depending on the image, you may hear the Auto Iris operating, but this is not a malfunction.

Setting Frame Interpolation

You can play fast moving images smoothly by automatically producing intermediate frames between the original frames.

Frame Interpolation is available under the following conditions.

- When **Image Processing** is set to **Fine**.  **Signal - Advanced - Image Processing** p.74
- When the source is HDMI1, HDMI2, or WirelessHD (EH-TW9400W/EH-TW8400W only).

- When inputting 2D signals* or 3D signals (1080p 24 Hz). [p.112](#)

* This is unavailable when a 4K signal is being input. This is enabled only when **4K Enhancement** is set to **On** and 1080p 24 Hz signals are being input. [Image - Image Enhancement - 4K Enhancement p.72](#)

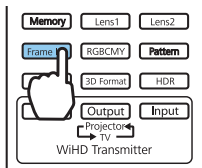

1

Press the **Frame Int.** button.



You can make settings from the Configuration menu. [Image - Frame Interpolation p.72](#)

2

Use the   buttons to select the item, and then press the  button to confirm the selection.



Adjusting the Color

Adjusting the Color Temp.

You can adjust the overall tint of the image. Make adjustments if the image is a little too blue or too red and so on.





Press the  button to display menus in the following order.

Image - Color Temp. - Color Temp.

Use the   buttons to make adjustments.

Blue tints grow stronger as the value is increased, and red tints grow stronger as the value is reduced.



Press the  button to return the adjustments to their default values.

Adjusting the RGB (Offset and Gain)

You can adjust the brightness of dark areas (Offset) and bright areas (Gain) for R (red), G (green), and B (blue).





Press the  button to display menus in the following order.

Image - Color Temp. - Customized

Use the   buttons to select the item, and then use the   buttons to make the adjustments. The image becomes brighter when moved to the right (positive) and darker when moved to the left (negative).



Offset	When the image is made brighter, shading for the darker sections is more vividly expressed. When the image is made darker, the image appears more full-bodied but shading for the darker sections is harder to distinguish.
Gain	When the image is made brighter, the bright sections become whiter and shading is lost. When the image is made darker, shading for the bright sections is more vividly expressed.



Press the  button to return the adjustments to their default values.

Adjusting Hue, Saturation, and Brightness

You can adjust the hue, saturation, and brightness for each of the R (red), G (green), B (blue), C (cyan), M (magenta), and Y (yellow) colors.

Hue	Adjusts the overall color of the image to be blue, green, or red.
Saturation	Adjusts the overall vividness of the image.
Brightness	Adjusts the overall color brightness of the image.

1 Press the **RGBCMY** button.

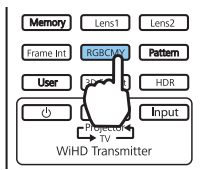

You can make settings from the Configuration menu. **Image - Advanced - RGBCMY** p.72

2 Use the buttons to select the color you want to adjust, and then press the button to confirm the selection.

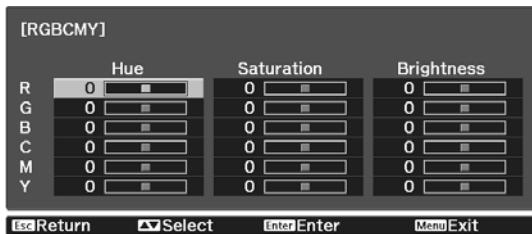

3 Use the buttons to select **Hue, Saturation, or Brightness**.

4 Use the buttons to make adjustments.

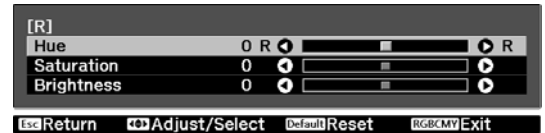

Press the button to adjust another color.

Press the button to return the adjustments to their default values.

5 Press the **RGBCMY** button to exit the menu.

Adjusting the Gamma



You can adjust slight coloration differences that may occur due to the device being used when the image is displayed.

You can set it by using one of the following three methods.

- Select and adjust the correction value
- Adjust using the gamma adjustment graph

■ Select and adjust the correction value

1 Press the  button to display menus in the following order.
Image - Advanced - Gamma

2 Use the   buttons to select the correction value, and then press the  button to confirm the selection.



The larger the value, the lighter the dark portions of the image become, but bright areas may appear discolored. The upper part of the gamma adjustment graph becomes rounded.
The smaller the value, the darker the bright portions of the image become. The lower part of the gamma adjustment graph becomes rounded.





- The horizontal axis of the gamma adjustment graph shows the input signal level, and the vertical axis shows the output signal level.
- Select **Reset** to return the adjustments to their default values.



■ Adjust using the gamma adjustment graph

Select a tone point on the graph and make adjustments.

1 Press the  button to display menus in the following order.
Image-Advanced-Gamma-Customized

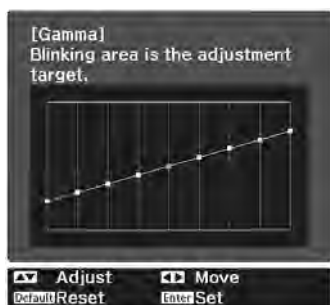
2 Use the   buttons to select the tone you want to adjust from the graph.



3 Use the   buttons to adjust the brightness, and then press the  button to confirm the selection.

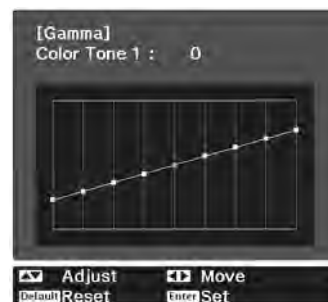

Viewing the Image at the Saved Image Quality (Memory Function)

Saving a Memory



By using the memory function, you can register the following adjustment values, and then load them when necessary.

- **Image** setting from the Configuration menu
- Adjustment values for Lens Adjustment Function (Focus, Zoom, Lens Shift, Blanking)  [p.28](#)

1 Make the settings or adjustments you want to register.

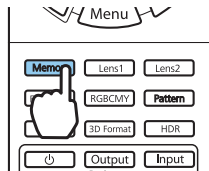
2 Press the  button.



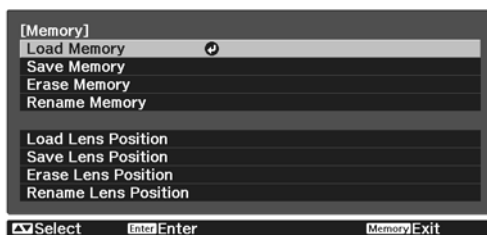

3 Use the   buttons to select **Save Memory** or **Save Lens Position**, and then press the  button to confirm the selection.



Save Memory: Registers the **Image** settings

Save Lens Position: Registers the adjustment value for the lens adjustment function

4 Use the   buttons to select the memory name to be saved, and then press the  button to confirm the selection.

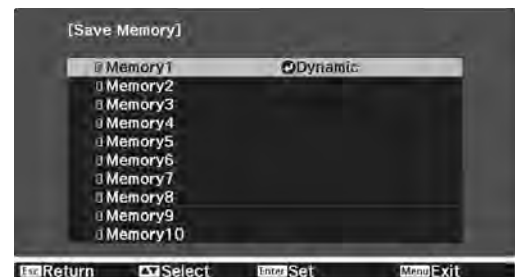

The current projector settings are saved to the memory.



If the mark on the left of the memory name is turned aqua, it means the memory has already been registered. When you select a registered memory, a message is displayed asking you to confirm that you want to overwrite the memory. If you select **Yes**, the previous content is erased and the current settings are saved.













Loading, Deleting, and Renaming a Memory

You can load, delete, and rename registered memories.

Press the  button, and then select the target function on the screen displayed.



- Press the   buttons on the remote control to load the lens position from the Save Lens Position registered in **Memory1** or **Memory2**.
- The position of the lens when loading the memory and the position of the lens when the memory is registered may not be exactly the same.

Function	Explanation
Load Memory	Loads the saved memory. When you select a memory and press the  button, the settings applied to the current image are replaced with the settings from the memory.
Erase Memory	Erases the registered memory. When you select a memory name and press the  button, a message is displayed. Select Yes , and then press the  button to erase the selected memory.
Rename Memory	Changes the memory name. Select the memory name you want to change, and then press the  button. Enter the memory name using the soft keyboard.  p.83 When you have finished, move the cursor over Finish , and then press the  button.
Load Lens Position	Loads the registered lens position memory. When you select the lens position name and press the  button, the adjustment value for the selected lens position memory is applied.
Erase Lens Position	Erases the registered lens position memory. When you select a lens position name and press the  button, a message is displayed. Select Yes , and then press the  button to erase the selected lens position memory.
Rename Lens Position	Changes the lens position memory name. Select the lens position memory name you want to change, and then press the  button. Enter the lens position memory name using the soft keyboard.  p.83 When you have finished, move the cursor over Finish , and then press the  button.

Enjoying 3D Images

Preparing to View 3D Images

To view 3D images, be sure to prepare a pair of commercially available 3D Glasses with an active shutter system that supports radio waves (RF/Bluetooth) communication system in advance.

Check the following before viewing 3D images.

- When the source is HDMI1, HDMI2, or WirelessHD (EH-TW9400W/EH-TW8400W only).
- Set **3D Display** to **Auto** or **3D**.
When this is set to **2D**, change to **Auto** or **3D**. **Signal - 3D Setup - 3D Display** p.74
- Pair 3D Glasses.

This projector supports the following 3D formats.

- Frame Packing
- Side by Side
- Top and Bottom

If the 3D image cannot be viewed

The projector automatically projects a 3D image when detecting a 3D format.

Some 3D TV broadcasts may not contain 3D format signals. If this happens, follow the steps below to set the 3D format.

1 Press the button to display menus in the order **Signal - 3D Setup**.

2 Set **3D Display** to **3D**.

3 Press the button to set the 3D format on the AV device.

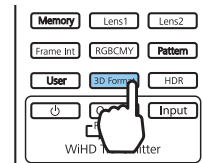

- If you are using a device or cable that does not support 3D images, 3D projection cannot be performed.
- For details on 3D format settings on the AV device, see the documentation supplied with the AV device.
- When the 3D format has not been correctly set up, an image will not be correctly projected as shown below.

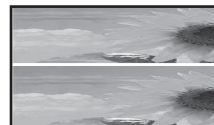
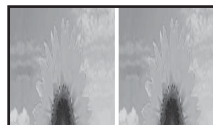

- If a 3D image is not projected correctly even when a 3D format is set, the synchronization timing for the 3D Glasses may be inverted. Inverse the synchronization timing using **Inverse 3D Glasses**. **Signal - 3D Setup - Inverse 3D Glasses** p.74
- How a 3D image is perceived varies depending on the individual.
- When you start projecting a 3D image, a warning about viewing 3D images is displayed. You can turn off this warning by setting **3D Viewing Notice** to **Off**. **Signal - 3D Setup - 3D Viewing Notice** p.74
- During 3D projection, the following Configuration menu functions cannot be changed. Aspect (set to Normal), Noise Reduction (set to Off), Overscan (set to Off), 4K Enhancement, Super-resolution, Image Processing
- How the 3D image is viewed may change depending on the temperature of the surroundings and how long the lamp has been used. Refrain from using the projector if the image is not projected normally.

Using 3D Glasses

You can view 3D images by using a pair of commercially available 3D Glasses (with an active shutter system that supports radio waves (RF/Bluetooth) communication system).

To view 3D images, you first need to pair the 3D Glasses with the projector. See the User's Guide supplied with your 3D Glasses for more information.

Warnings Regarding Viewing 3D Images

Note the following important points when viewing 3D images.

Caution

Viewing Time

- When viewing 3D images, always take periodic breaks during extended viewing. Long periods of viewing 3D images may cause eye fatigue. The amount of time and frequency of such breaks varies from person to person. If your eyes still feel tired or uncomfortable even after taking a break from viewing, stop viewing immediately.

Caution

Watching 3D Images

- If your eyes feel fatigued or uncomfortable when viewing 3D images, stop viewing immediately. Continuing to view the 3D images could cause you to feel unwell.
- When viewing 3D images be sure to always wear 3D Glasses. Do not attempt to view 3D images without 3D Glasses. Doing so could cause you to feel unwell.
- Do not place any breakable or fragile objects around you when using 3D Glasses. 3D images may cause you to move your body involuntarily, resulting in damage to nearby items or personal injury.
- Only wear 3D Glasses when viewing 3D images. Do not move around while wearing 3D Glasses. Your vision may appear darker than normal, causing you to fall or injure yourself.
- Try to stay as level with the viewing screen as possible when viewing 3D images. Viewing 3D images at an angle reduces the 3D effect and may cause you to feel unwell due to unintended color changes.
- If using 3D Glasses in a room with fluorescent or LED lighting, you may see flashing or flickering throughout the room. If this should occur, reduce the lighting until the flickering goes away or turn off the lights completely when viewing 3D images. In some very rare cases, this flickering could trigger seizures or fainting for some individuals. If you begin to feel uncomfortable or unwell at any time when viewing 3D images, stop immediately.
- Stay at least three times the height of the screen away from the screen when viewing 3D images. The recommended viewing distance for an 80-inch screen is at least 3 meters, and at least 3.6 meters for a 100-inch screen. Sitting or standing any closer than the recommended viewing distance may result in eye fatigue.

 Caution

Health Risks

- You should not use 3D Glasses if you are sensitive to light, have a heart condition, or are unwell. Doing so could aggravate your pre-existing conditions.

 Caution

Recommended Age of Use

- The minimum recommended age to view 3D images is six years old.
- Children under the age of six are still developing and viewing 3D images may cause complications. Consult your doctor if you have any concerns.
- Children viewing 3D images through 3D Glasses should always be accompanied by an adult. It is often difficult to tell when a child is feeling tired or uncomfortable, which could result in them feeling suddenly unwell. Always check with your child to ensure that they are not experiencing any eye fatigue during viewing.

Connecting with WirelessHD

Installing the WirelessHD Transmitter

You can use the supplied WirelessHD Transmitter to wirelessly receive image and sound data.

This is useful when the projector cannot be setup near your AV devices as you can connect the devices to the projector without using cables.







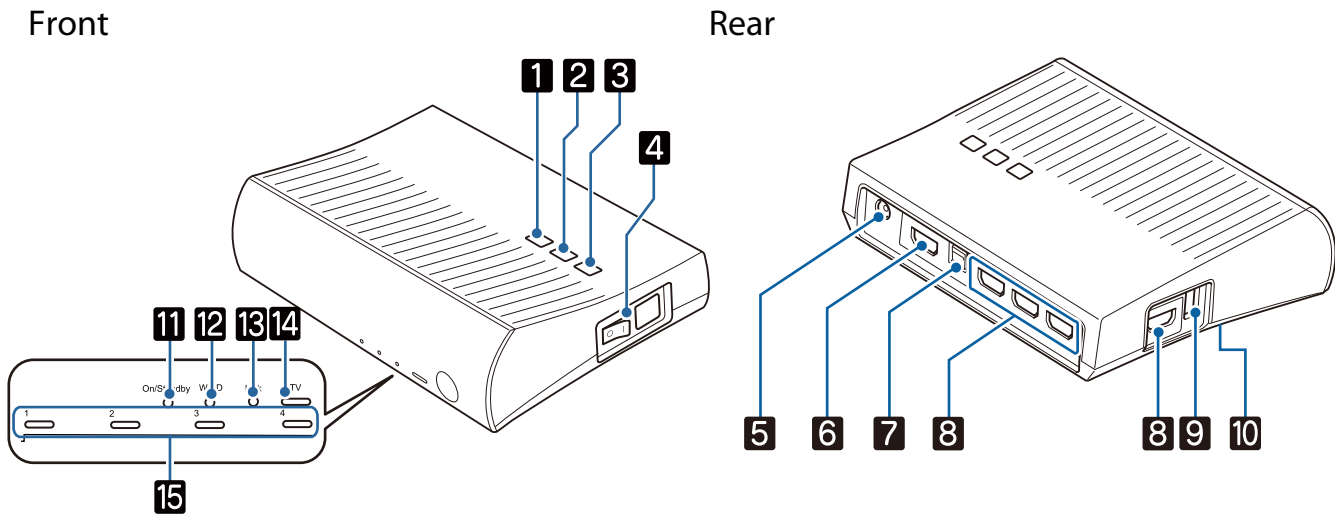

You can use the WirelessHD Transmitter in the following ways.

- You can connect up to four AV devices at the same time, and switch images using the remote control.
- As well as the projector, you can connect another monitor device, such as a television, to the HDMI Out port, and then switch the output using the remote control.
- This allows other monitor devices such as TVs connected to the HDMI Out port to project images from the connected AV device, even if the projector is off.
- You can connect smart devices and tablets that support MHL, and then project images from the connected MHL device. You can also operate MHL devices from the projector's remote control, as well as charge the MHL device.
- You can split the HDMI signal that is being input into the WirelessHD Transmitter into image and audio, and output to other devices.
- Even for AV devices that do not support HDCP 2.2, you can output audio by connecting to the HDMI Out port on the WirelessHD Transmitter.

WirelessHD Transmitter part names



Name		Function
1	⏻ button	Turns the transmitter on or off. This performs the same function as the  button for the WirelessHD Transmitter control on the lower section of the remote control.
2	 button	Changes to the image from each input port. This performs the same function as the  button for the WirelessHD Transmitter control on the lower section of the remote control.
3	 button	Switches the output image to the projector or the device connected to the HDMI Out port. This performs the same function as the  button for the WirelessHD Transmitter control on the lower section of the remote control.
4	Main power switch	Turns the main power for the transmitter on or off.
5	AC adapter port	Connects the AC adapter.
6	HDMI Out port	Connects to a monitor device, such as a television. You can switch the output image using the  button on the remote control or the  button on the WirelessHD Transmitter.
7	Optical Audio-Out port	Connects to an audio device equipped with an optical digital audio input port.
8	HDMI Input port	Connects to the AV device you want to playback. You can switch the input image using the Input button. The HDMI4 port of the unit meets the MHL standards. You can play content from MHL compatible smart devices or tablets connected with an MHL cable.
9	3D Glasses charging port	Connects a USB cable to charge the 3D Glasses.
10	Setup button	This is the button on the back of the WirelessHD Transmitter. This is a pairing button for changing devices. Do not use this button under normal circumstances since this transmitter is already configured before the shipment.
11	On/Standby indicator (blue)	This flashes while the WirelessHD Transmitter is starting up, and remains lit while operating.

Name		Function
12	WiHD indicator (blue)	Indicates the communication status for the WirelessHD. <ul style="list-style-type: none"> • Lit when wirelessly transmitting images to the projector. • Off when outputting to the HDMI Out port.
13	Link indicator (blue)	Indicates the connection status with the projector. <ul style="list-style-type: none"> • Turns on when connected to the projector. • Flashes when searching for a projector. • Flashes slowly when standing by in power saving status.
14	TV indicator (blue)	Lit when a monitor device such as a TV is selected as the output.
15	HDMI1 to 4 indicators (blue)	The indicator for the source currently being projected is lit.

WirelessHD Transmitter connection example and signal flow



- The antennas are built-into the front of the projector and the WirelessHD Transmitter. Make sure the antennas face each other (face the front) when setting up the devices. Also, do not place any object over the front side of the projector and WirelessHD Transmitter.
- Place the WirelessHD Transmitter on a level surface facing towards the projector.
- You can view the signal strength from the **WirelessHD** settings menu. **Settings - WirelessHD - Video Reception** [p.75](#)
- When outputting audio from devices connected to the Optical Audio-Out port or the HDMI Out port, set the output audio in **Audio Out Device**. [p.61](#)
- You can output images from the projector or a monitor device such as TV. You can switch the output image using the button on the remote control or the button on the WirelessHD Transmitter. [p.59](#)
- When inputting images from HDMI Input1 or HDMI Input2 port, if noise is generated by monitors such as televisions or if the audio is lost, try connecting to the HDMI Input3 or HDMI Input4 port.
- This projector cannot transmit signals in the 18 Gbps transmission band such as 4K60p/4:4:4 using a wireless network.

Connection example 1: Viewing without an AV amplifier (audio is output from the Optical Audio-Out port)

Audio is output from the sound bar connected to the Optical Audio-Out port. Use a commercially available optical digital cable to connect to the sound bar.

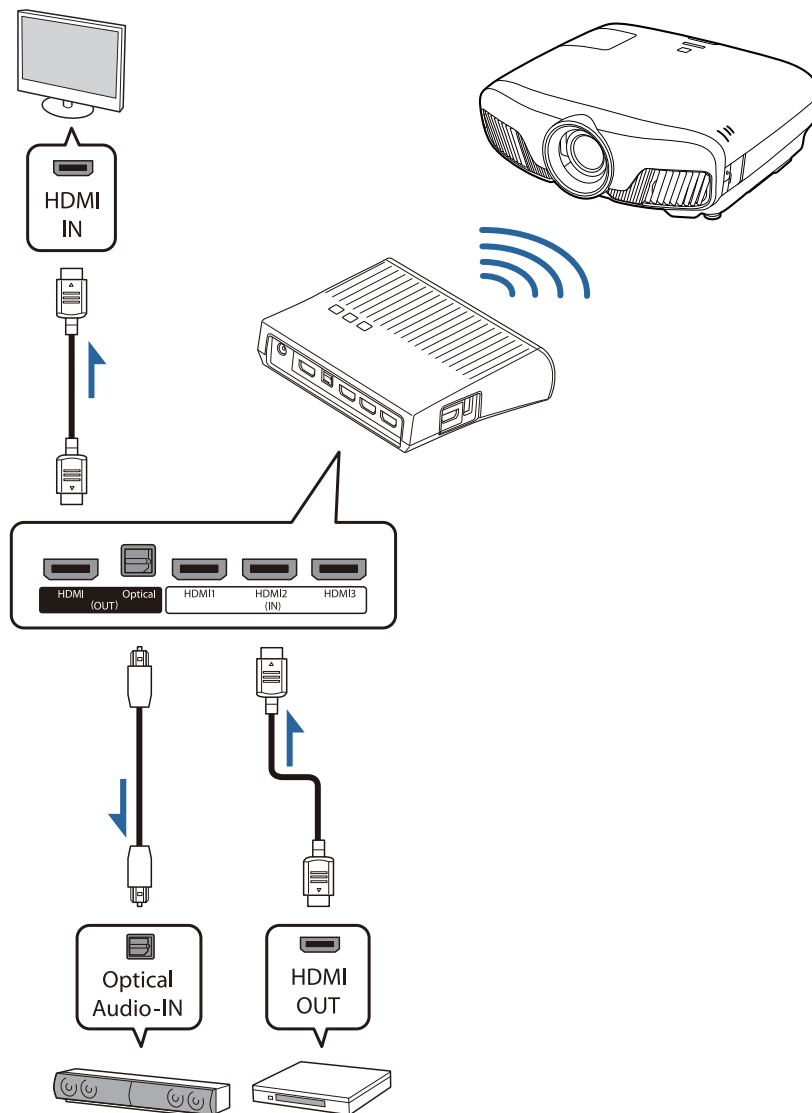

- When connecting a device, such as a sound bar, to the Optical Audio-Out port on the WirelessHD Transmitter, check that **Audio Out Device** is set to **WiHD Transmitter (Optical)**. [Settings - HDMI Link - Audio Out Device p.75](#)
 - The following conditions must be met when you want to output images from monitor devices including TVs that support 18 Gbps transmission band, such as 4k60p/4:4:4.
 - Connect the monitor device to the HDMI Out port with a Premium HDMI cable.
 - Connect the AV device to the HDMI Input1 or HDMI Input2 port.
 - You cannot output some audio from the Optical Audio-Out port due to restrictions in audio standards*.
 - Lossless audio
 - Lossy high-bandwidth audio
 - Immersive audio
- * This is the specifications as of June 2018. This will be changed in the future.

Connection example 2: Viewing without an AV amplifier (audio is output from the HDMI Out port)

Audio is output from the sound bar and so on connected to the HDMI Out port. In this situation, you can even output audio from AV amplifiers or sound bars that do not support HDCP 2.2.

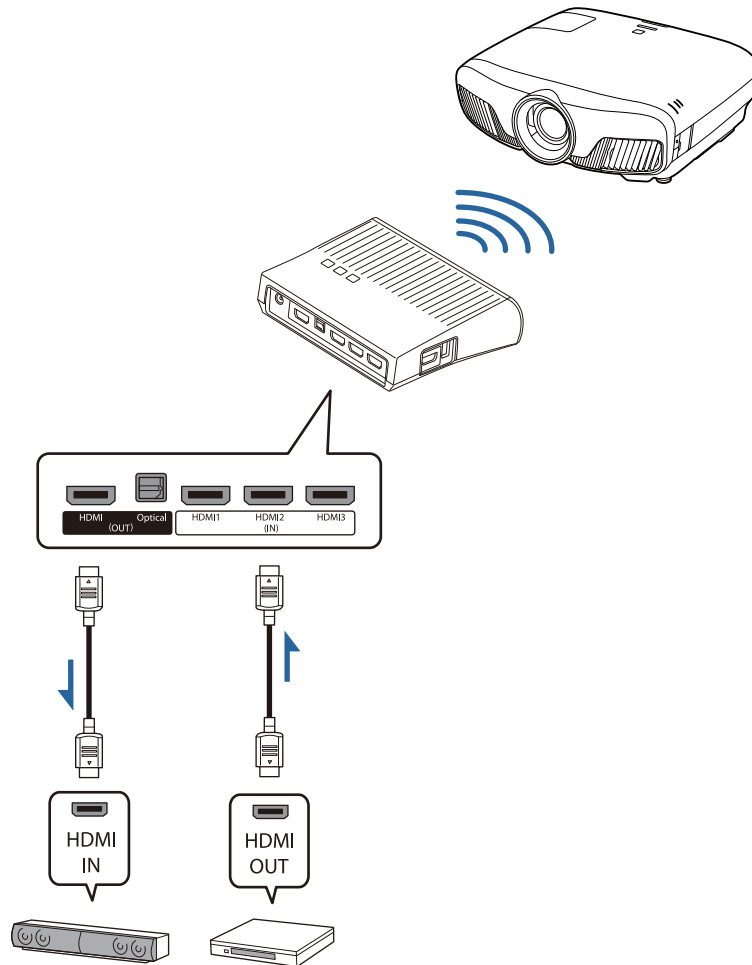

When connecting a device, such as a sound bar, to the HDMI Out port on the WirelessHD Transmitter, check that **Audio Out Device** is set to **WiHD Transmitter (HDMI)**.  **Settings - HDMI Link - Audio Out Device** [p.75](#)

Connection example 3: Viewing with a connected AV amplifier

Connect using an AV amplifier.

Audio is output from the AV amplifier.

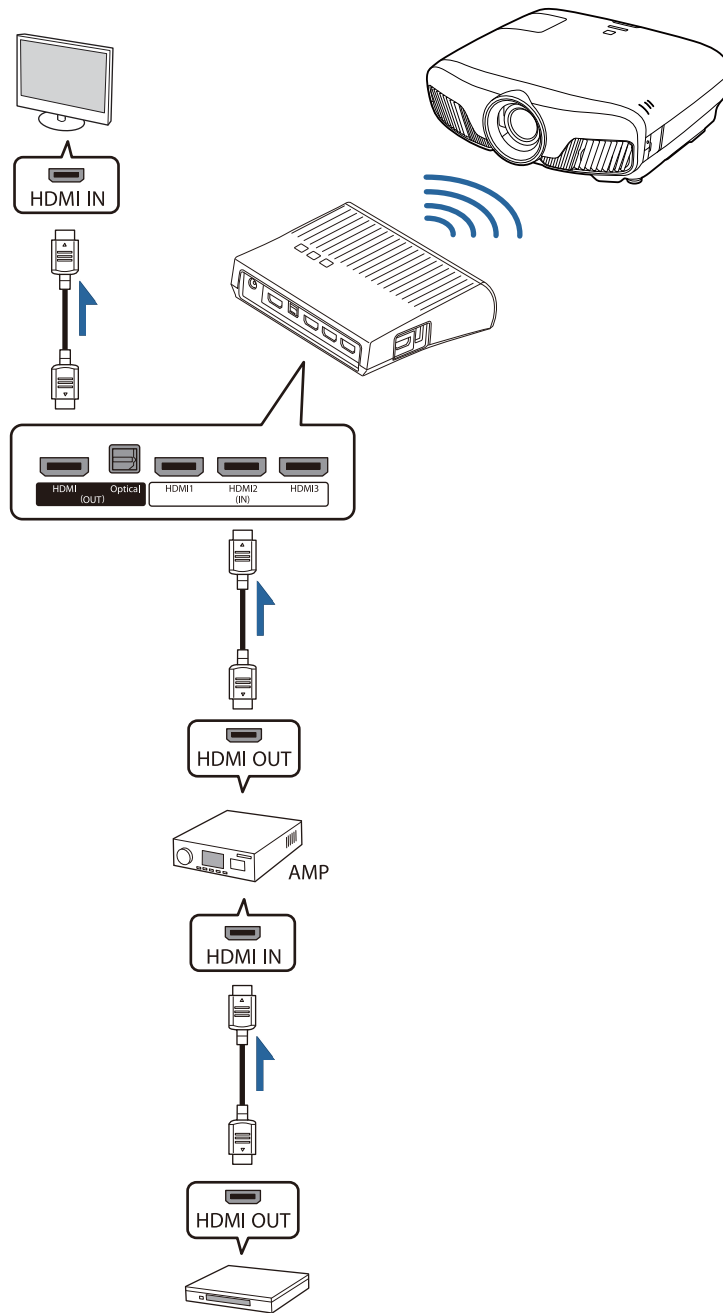

Connection example 4: Viewing with a connected smart device

Connect an MHL cable to the HDMI4 port.

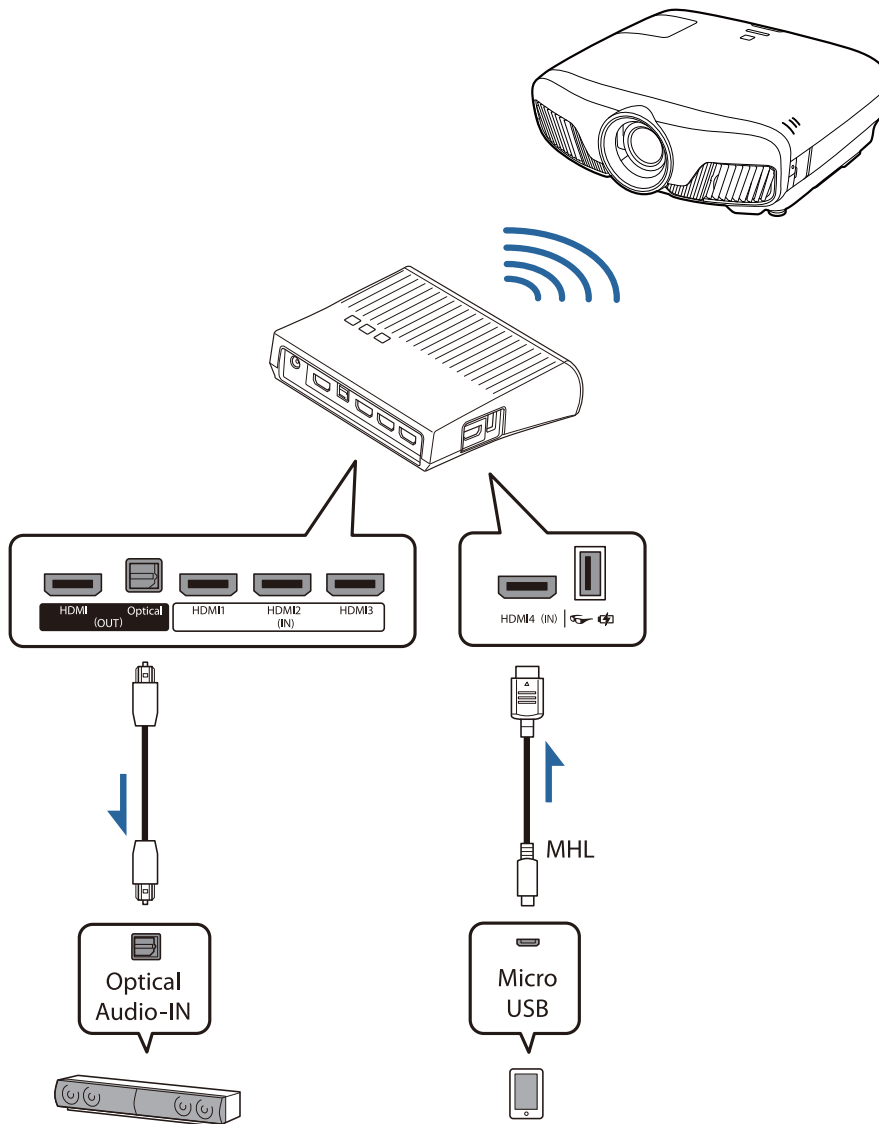

Setting the WirelessHD Transmitter

- 1 Set up the WirelessHD Transmitter connected to the projector so that they are facing each other.  [p.47](#)



- The antennas are built-into the front of the projector and the WirelessHD Transmitter. Make sure the antennas face each other (face the front) when setting up the devices. Also, do not place any object over the front side of the projector and WirelessHD Transmitter.
- Place the WirelessHD Transmitter on a level surface facing towards the projector.

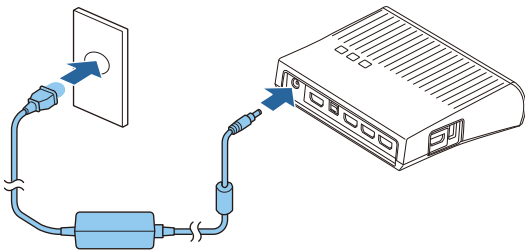

- 2 Connect the WirelessHD Transmitter to an electrical outlet using the supplied AC adapter.

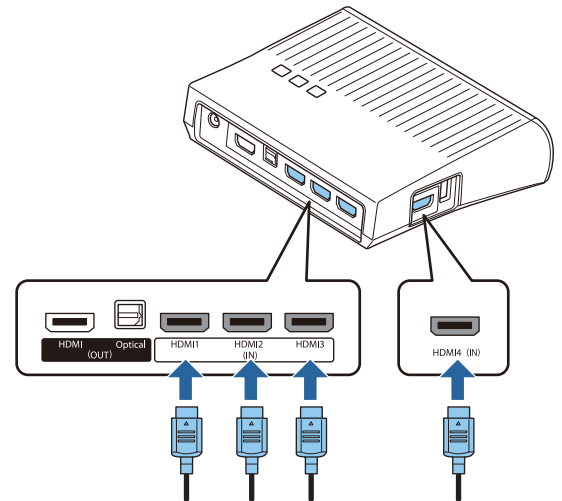

- 3 Using an HDMI cable, connect the AV device you want to use to the Input port on the WirelessHD Transmitter.

You can connect up to four multi-media players.



- You can connect another monitor device, such as a television, to the HDMI Out port on the WirelessHD Transmitter. You can switch between output images using the remote control.  [p.59](#)
- The HDMI4 port of the WirelessHD Transmitter supports the MHL input signal. You can play content from MHL compatible smart devices or tablets connected with an MHL cable.
- If the following message is displayed when you connect an MHL device, the device has been connected to a port other than the HDMI4 port, or the connected device is not compatible with MHL.
"No Signal"
- You can use the HDMI link function even when using the WirelessHD Transmitter.  [p.61](#)

Projecting Images

- 1 Start playback on the AV device, and then turn on the projector and the WirelessHD Transmitter.

The On/Standby indicator on the WirelessHD Transmitter turns on.

Free Manuals Download Website

<http://myh66.com>

<http://usermanuals.us>

<http://www.somanuals.com>

<http://www.4manuals.cc>

<http://www.manual-lib.com>

<http://www.404manual.com>

<http://www.luxmanual.com>

<http://aubethermostatmanual.com>

Golf course search by state

<http://golfingnear.com>

Email search by domain

<http://emailbydomain.com>

Auto manuals search

<http://auto.somanuals.com>

TV manuals search

<http://tv.somanuals.com>