

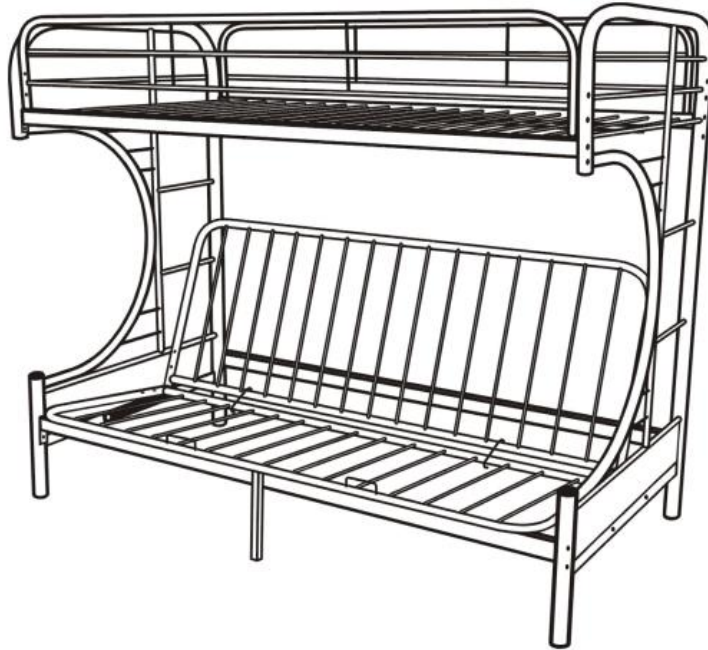

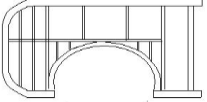







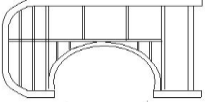







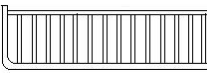

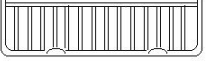



# ASSEMBLY INSTRUCTIONS

MODEL: 02093    PAGE 1 OF 6

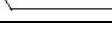
**NOTE: THIS ITEM NOT RECOMMENDED FOR COMMERCIAL USE  
KEEP THIS DOCUMENT FOR REFERENCE IN CASE PARTS ARE NEEDED  
DO NOT TIGHTEN SCREWS UNTIL COMPLETELY ASSEMBLED!!**



BED PARTS				HARDWARE PARTS			
No	DESCRIPTION		QTY	No	DESCRIPTION	QTY	
A		Left Side Panel	1 Pc	1	 Hex-Head 5/16"X45mm Bolts	9 Pcs	
				2	 Hex-Head 1/4"X75mm Bolts	8 Pcs	
B		Right Side Panel	1 Pc	3	 Hex-Head 1/4"X60mm Bolts	16 Pcs	
				4	 Hex-Head 5/16"X35mm Bolts	4 Pcs	
C		Cross Braces	2 Pcs	5	 1/4"Curved Washers	24 Pcs	
D		Top Frame	1 Pc	6	 Hex-Head 1/4"x20mm Bolts	8 Pcs	
				7	 5/16"Curved Washers	8 Pcs	
E		Upper Futon Frame	1 Pc	8	 1/4" Washers	8 Pcs	
				9	 1/4" Nuts	8 Pcs	
F		Lower Futon Frame (with 2 Handles)	1 Pc	10	 C-Hook	2 Pcs	
				11	 Protective Pads	4 Pcs	
G		Guardrails	2 Pcs	12	 5/16" Washers	12 Pcs	
H		Left Hinge	1 Pc	13	 5/16" Nuts	12 Pcs	
I		Right Hinge	1 Pc	14	 11#、13# Open Wrench	2 Pcs	
M		Supporting leg	1 Pc	15	 4#、5# Allen Wrenches	2 Pcs	
				16	 Plastic pad	4 Pcs	
				17	 Safety Hook	1 Pc	

# ASSEMBLY INSTRUCTIONS

MODEL: 02093 PAGE 2 OF 6

**NOTE: THIS ITEM NOT RECOMMENDED FOR COMMERCIAL USE  
KEEP THIS DOCUMENT FOR REFERENCE IN CASE PARTS ARE NEEDED  
DO NOT TIGHTEN SCREWS UNTIL COMPLETELY ASSEMBLED!!**

## STEP 1:

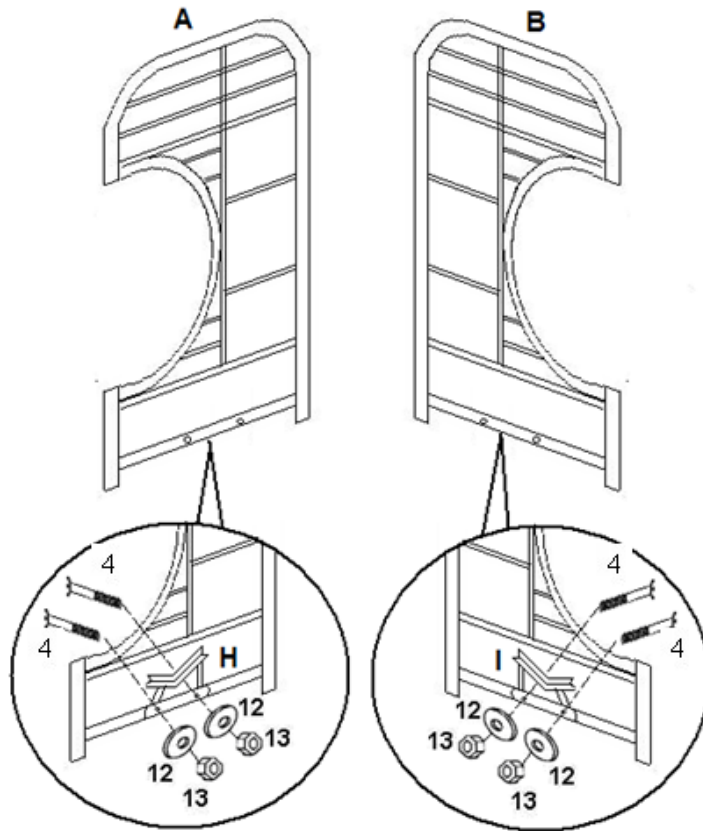

## STEP 2:

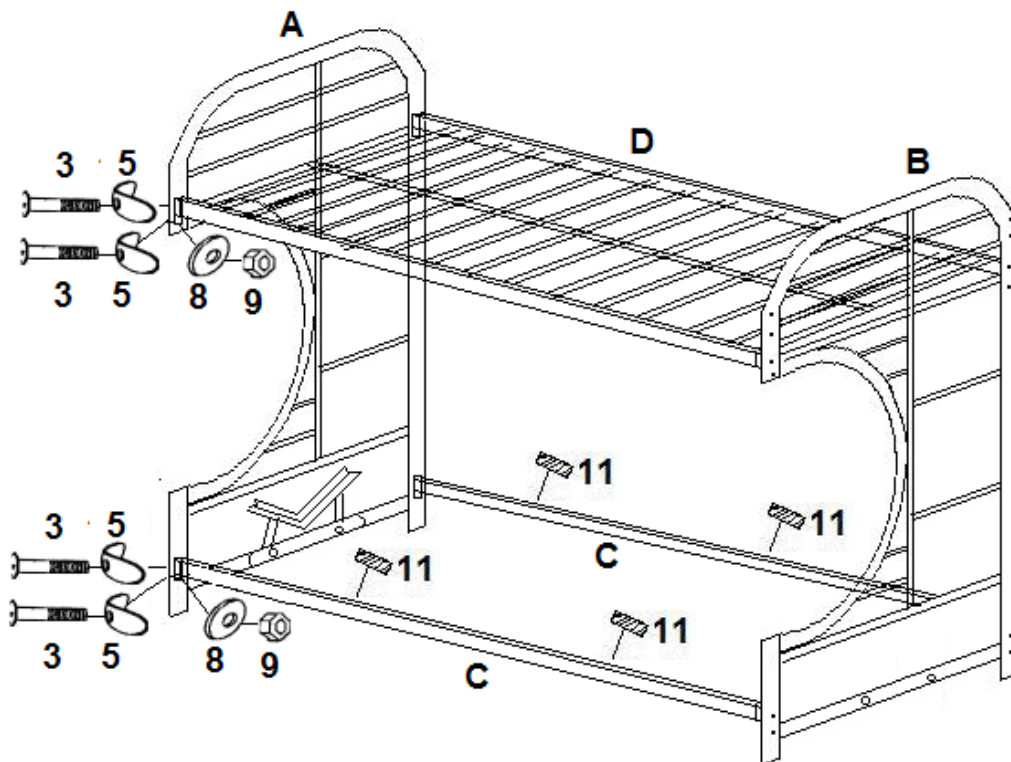

# ASSEMBLY INSTRUCTIONS

MODEL: 02093 PAGE 3 OF 6

**NOTE: THIS ITEM NOT RECOMMENDED FOR COMMERCIAL USE  
KEEP THIS DOCUMENT FOR REFERENCE IN CASE PARTS ARE NEEDED  
DO NOT TIGHTEN SCREWS UNTIL COMPLETELY ASSEMBLED!!**

## STEP 3:

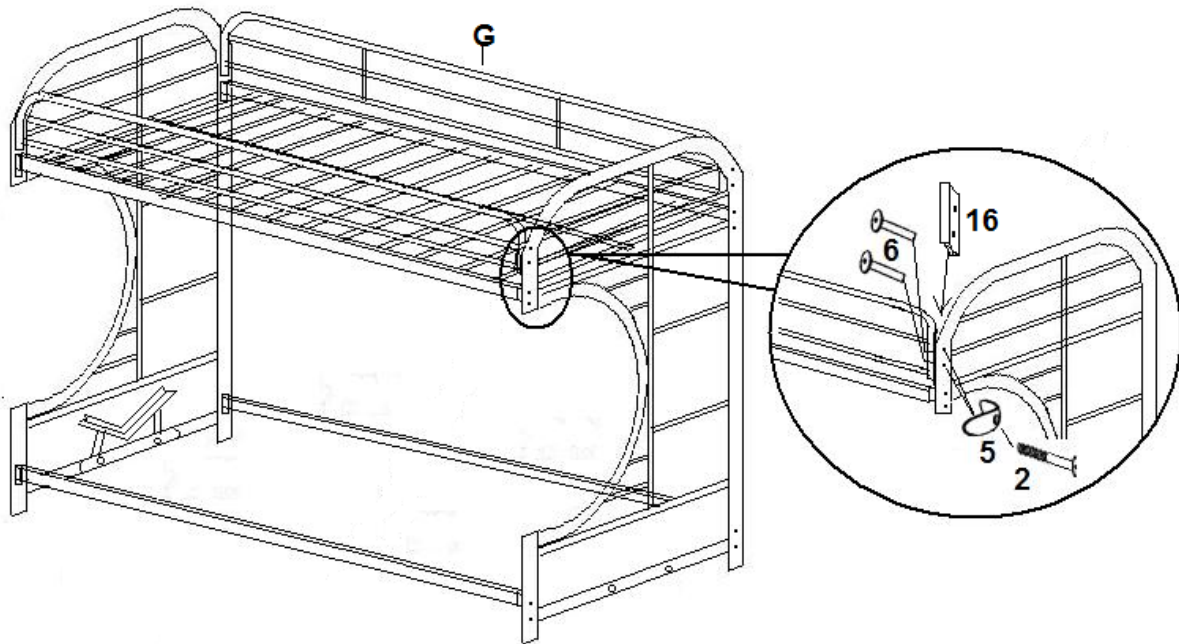

## STEP 4:

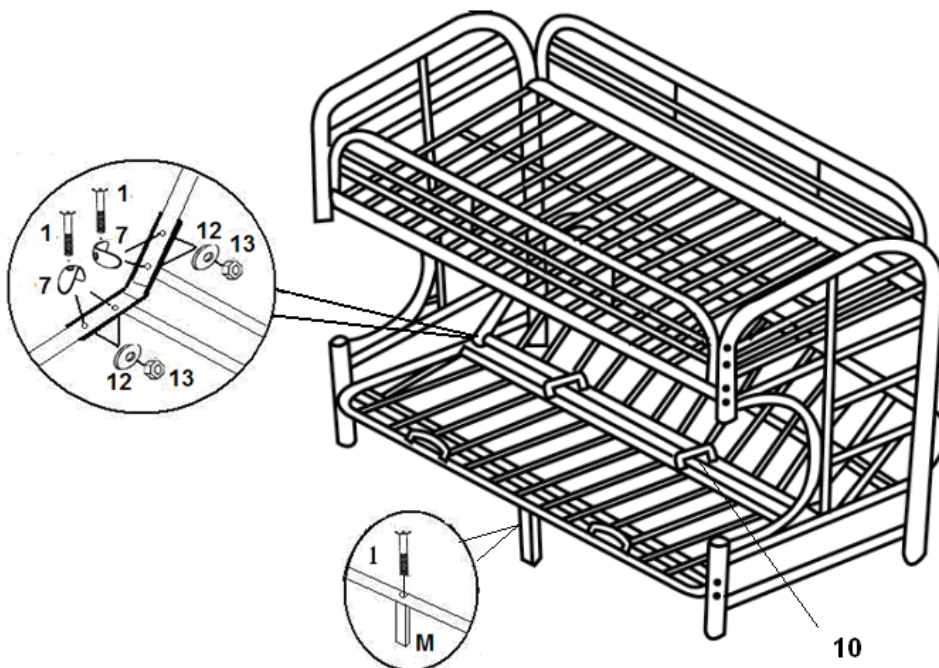

### **Remark:**

**Please always keep the warning lable on the inside of the upper bed end structure permanently.**

# ASSEMBLY INSTRUCTIONS

MODEL: 02093 PAGE 4 OF 6

**NOTE: THIS ITEM NOT RECOMMENDED FOR COMMERCIAL USE  
KEEP THIS DOCUMENT FOR REFERENCE IN CASE PARTS ARE NEEDED  
DO NOT TIGHTEN SCREWS UNTIL COMPLETELY ASSEMBLED!!**

## REMARK: PART 17—SAFETY HOOK

- Always use the safety hook to fix Lower Futon Frame (Part F) and Cross Braces (Part C) together once you have placed Futon in horizontal or seat.
- Adult assembly required.

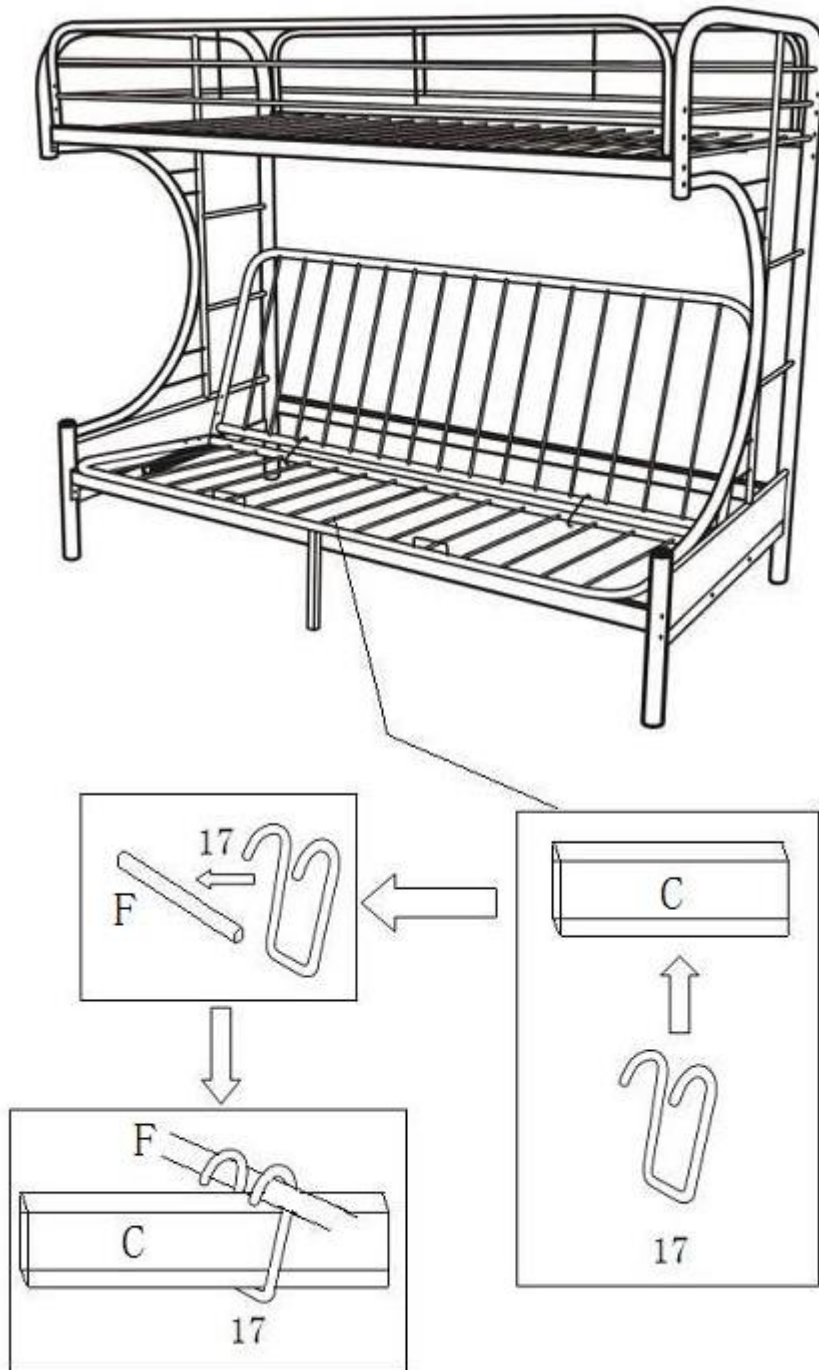

- If you need to switch from futon to full bed, you will have to remove the hook first before place the futon down !

# ASSEMBLY INSTRUCTIONS

MODEL: 02093 PAGE 5 OF 6

**NOTE: THIS ITEM NOT RECOMMENDED FOR COMMERCIAL USE  
KEEP THIS DOCUMENT FOR REFERENCE IN CASE PARTS ARE NEEDED  
DO NOT TIGHTEN SCREWS UNTIL COMPLETELY ASSEMBLED!!**

## Size of Mattress

This bed is designed to use a mattress **80" x 37-1/2" – 38-1/2"** on the upper bunk and **80" x 59-1/2" – 60"** on the lower bunk. The thickness of the mattress must not exceed **6"** on the upper bunk. There must be at least **5"** from mattress sleeping surface to top edge of guard rail on the upper bunk.

## Replacement Parts

Replacement parts, including additional guardrails, may be obtained from any of our retail dealers.

## Additional Note

Maximum total weight not to exceed **150 lbs.** on the upper bunk, and maximum **200 lbs.** on the lower bunk.

## SAFETY WARNINGS (ASTM F1427-13)

1. Follow the information on the warnings appearing on the upper bunk end structure and on the carton. Do not remove warning label from bed.
2. Always use the recommended size mattresses or mattress supports, or both, to help prevent the likelihood of entrapment or falls.
3. Surface of mattress must be at least 5 in. (127 mm) below the upper edge of guardrails.
4. Do not allow children under 6 years of age to use the upper bunk.
5. Periodically check and ensure that the guardrail, ladder, and other components are in their proper position, free from damage, and that all connectors are tight.
6. Do not allow horseplay on or under the bed and prohibit jumping on the bed.
7. Always use the ladder for entering and leaving the upper bunk.
8. Do not use substitute parts. Contact the manufacturer or dealer for replacement parts.
9. Use of a night light may provide added safety precaution for a child using the upper bunk.
10. Always use guardrails on both long sides of the upper bunk. If the bunk bed will be placed next to the wall, the guardrail that runs the full length of the bed should be placed against the wall to prevent entrapment between the bed and wall.
11. The use of water or sleep flotation mattresses is prohibited.
12. **STRANGULATION HAZARD**–Never attach or hang items to any part of the bunk bed that are not designed for use with the bed; for example, but not limited to, hooks, belts and jump ropes.
13. Keep these instructions for future reference.
14. Prohibit more than one person on upper bunk.
15. Adult assembly required due to the presence of small parts ,sharp points,sharp edgesas recessed.

# ASSEMBLY INSTRUCTIONS

MODEL: 02093 PAGE 6 OF 6

**NOTE: THIS ITEM NOT RECOMMENDED FOR COMMERCIAL USE  
KEEP THIS DOCUMENT FOR REFERENCE IN CASE PARTS ARE NEEDED  
DO NOT TIGHTEN SCREWS UNTIL COMPLETELY ASSEMBLED!!**

## **SAFETY WARNINGS ( 16 CFR 1513)**

- (1) Do not allow children under 6 years of age to use the upper bunk.
- (2) Use guardrails on both sides of the upper bunk.
- (3) Prohibit horseplay on or under beds.
- (4) Prohibit more than one person on upper bunk.
- (5) Use ladder for entering or leaving upper bunk.
- (6) If the bunk bed will be placed next to a wall, the guardrail that runs the full length of the bed should be placed against the wall to prevent entrapment between the bed and the wall. (This applies only to bunk beds without two full-length guardrails.)

## Free Manuals Download Website

<http://myh66.com>

<http://usermanuals.us>

<http://www.somanuals.com>

<http://www.4manuals.cc>

<http://www.manual-lib.com>

<http://www.404manual.com>

<http://www.luxmanual.com>

<http://aubethermostatmanual.com>

Golf course search by state

<http://golfingnear.com>

Email search by domain

<http://emailbydomain.com>

Auto manuals search

<http://auto.somanuals.com>

TV manuals search

<http://tv.somanuals.com>