

EN**English, 1****IDCE 845****IDCE 845 S**

! Keep this manual at hand for immediate reference whenever necessary. Always store this manual close to the tumble dryer and remember to pass it on to any new owners when selling or transferring the appliance, so they may familiarise with the warnings and suggestions herein contained.

! Read these instructions carefully: the following pages contain important information on installation and useful suggestions for operating the appliance.

Contents

Important information, 2-3

Installation, 4

Where to install the tumble dryer
Ventilation
Electrical connections
Preliminary information

Description of the tumble dryer, 5-6

Features
Control panel

How to carry out a drying cycle, 7

Starting and selecting a programme

Programmes and options, 8-9-10

Programme chart
Special programmes
Options
Opening the door

Laundry, 11-12

Sorting laundry
Care labels
Special garments
Drying times

Warnings and suggestions, 13

General safety
Information on recycling and disposal
Saving energy and respecting the environment

Care and maintenance, 14

Disconnecting the power supply
Cleaning the filter after each cycle
Checking the drum after each cycle
Emptying the water container after each cycle
Cleaning the condenser unit
Cleaning the tumble dryer

Troubleshooting, 15

Assistance and Guarantee, 16-17-18

Spare parts

Important information

EN

To ensure that the condenser dryer functions efficiently, the following routine maintenance procedures must be carried out:

Fluff filter – CLEAN off any fluff build-up on the filter after each drying cycle.

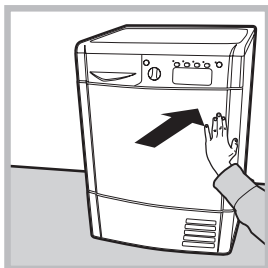

Step 1
Open the dryer door by pressing it as shown in the picture.

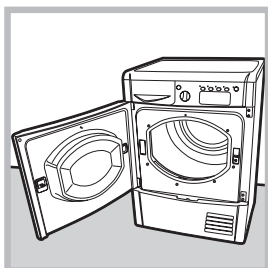

Step 2
Pull out the filter (using two fingers).

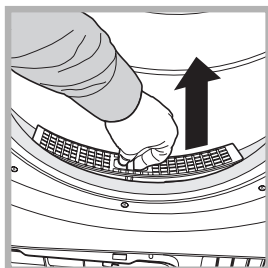

Step 3
Clean off any fluff build-up on the internal surface of the filter net.

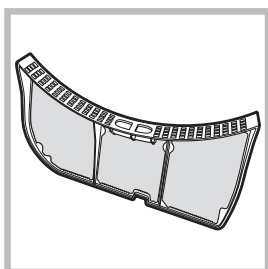

Step 4
Replace the filter – never operate the dryer without the filter in place.

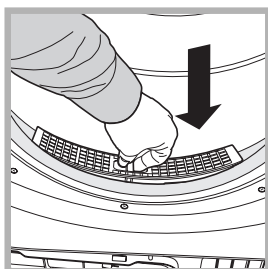

Failure to clean the filter after each drying cycle can undermine drying performance as the machine takes longer to dry and thus consumes more energy.

Water container – empty the water container after each drying cycle.

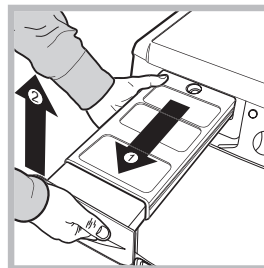

Step 1
Pull the water container towards you and remove it completely from the dryer.

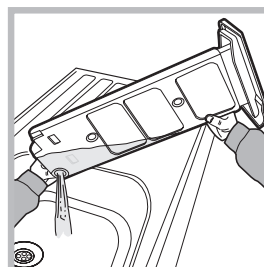

Step 2
Empty all the water in the water container.

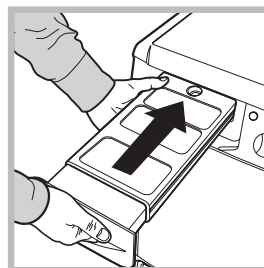

Step 3
Replace the water container making sure that it is securely fixed.

Failure to empty the water container may cause the following:

- The dryer stops heating (thus the load may still be damp at the end of the drying cycle).
- The “Empty water container” LED lights up to signal that the water container is full.

Filling of the Water Container

When the dryer is first used water will not immediately enter the water container as the pump needs to be primed. This is done automatically and will take a few minutes, during this period the efficiency of the drying process is not affected.

Condenser unit - remove any fluff build-up from the condenser on a monthly basis.

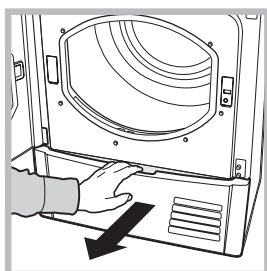

Step 1
Open the condenser cover
- grip the handle and pull
towards you.

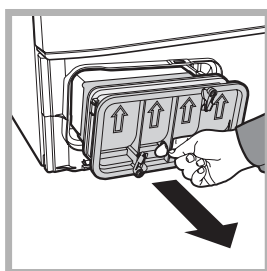

Step 2
Remove the condenser by
turning the 3 catches, then pull
the condenser towards you. (It is
normal for some residual water
to be left in the tubes).

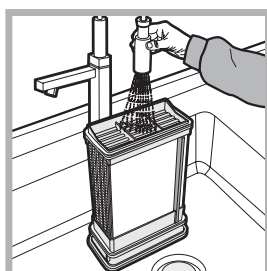

Step 3
Clean the condenser with running
water over the rear side to
remove any fluff deposits.

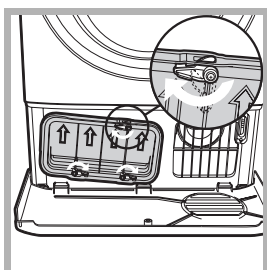

Step 4
Replace the condenser unit;
make sure that the unit is
securely in place, that all 3
catches are fixed and that the
position arrows on the front end
of the condenser are pointing
upwards.

Failure to clean the condenser unit may cause premature faults to the dryer.

Installation

EN

Where to install the tumble dryer

• Install the dryer far from gas ranges, stoves, radiators or hobs, as flames may damage it. If the dryer is installed below a worktop, ensure there are 10 mm between the upper panel of the dryer and any objects above it, and 15 mm between the sides of the machine and the walls or furniture units adjacent to it. This ensures adequate air circulation.

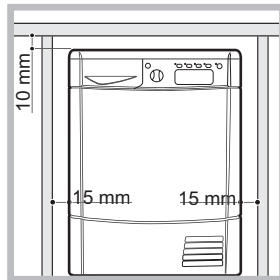

Ventilation

• The room must be adequately ventilated while the dryer is running. Make sure that the dryer is installed in a room free of humidity and with adequate air circulation. The flow of air around the dryer is essential to allow water to condense during drying; the dryer will not function properly if it is placed in an enclosed space or inside a cabinet.

! Some condensation may form if the dryer is used in a small or cold room.

! We do not recommend installing the dryer in a cupboard; moreover, never install the machine behind a lockable, sliding or hinged door located on the opposite side of the dryer door.

Water drain

If your dryer is installed next to a drain the water can be plumbed into this drain. This does away with the need to empty the water container. If the dryer is stacked onto or installed next to a washing machine it can share the same drain. The height of the drain must be less than 3' (1 m) from the bottom of the dryer.

Remove existing hose from position shown in picture A and fit a suitable length of hose and connect as shown in picture B.

! Make sure that the hose is not squashed or kinked when the dryer is in its final location.

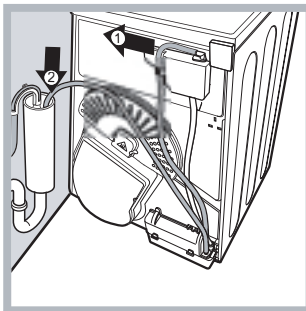

Picture A

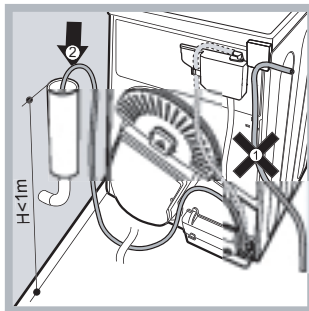

Picture B

Electrical connections

Before plugging the appliance into the socket, check the following:

- Make sure your hands are dry.
 - The socket must have an earth connection.
 - The socket must be able to withstand the machine's maximum power output as indicated on the data plate (see *Description of the tumble dryer*).
 - The power supply voltage must fall within the values indicated on the data plate (see *Description of the tumble dryer*).
 - The socket must be compatible with the dryer's plug. Should this not be the case, replace the plug or the socket.
 - ! Do not use extension cords.
 - ! The dryer must not be installed outdoors, even if the space is sheltered. It can be very dangerous if exposed to rain or storms.
 - ! Once installed, the dryer's electrical wire and plug must be within reach.
 - ! The power cord must not be bent or squashed.
 - ! The power cord is supplied fitted with a BS1363 plug and with a 13 amp BS1362 fuse. If it is necessary to fit a replacement fuse, it must be a 13 Amp ASTA approved to BS1362 type. **WARNING:** The plug must not be used without a fuse cover. If a replacement fuse holder/cover is required, it must be of the same colour coding or wording as shown on the base of the plug.
- Replacements are available from authorised dealers.

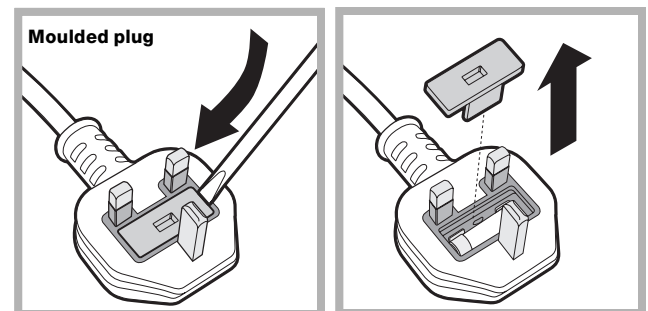

Changing the plug

The wires in the power cord are coloured in accordance with the following.

Green and Yellow (Earth) wire to terminal marked "E", symbol x, or coloured green and yellow.

Blue (Neutral) wire to terminal marked "N" or coloured black.

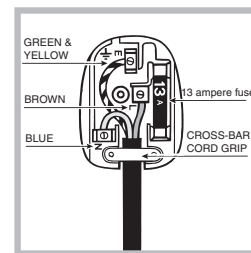

13A ASTA approved fuse to BS 1362.

Brown (live) wire to terminal marked "L" or coloured red.

- ! If the plug being replaced is a non-rewirable type, then the cut-off plug must be disposed of safely. **DO NOT** leave it where it can be inserted into a socket and create a shock hazard.
- ! The power cord should be checked periodically and replaced by a cord specially prepared for this dryer and fitted only by authorized technicians (see *Service*). New or longer power cords are supplied at an extra charge by authorized dealers.
- ! The manufacturer denies any responsibility should any of these rules not be followed.

! If in doubt about any of the above consult a qualified electrician.

Preliminary information

Once the tumble dryer is installed, clean the inside of the drum before operating it and remove any dirt accumulated during transportation.

Description of the tumble dryer

EN

Opening the door

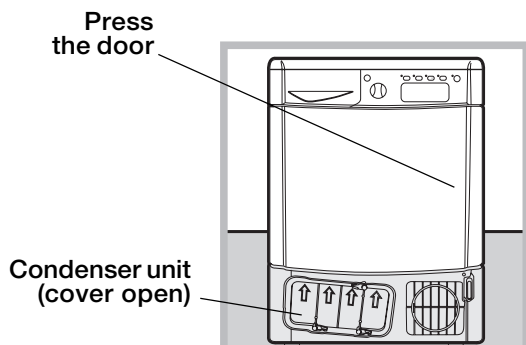

Features

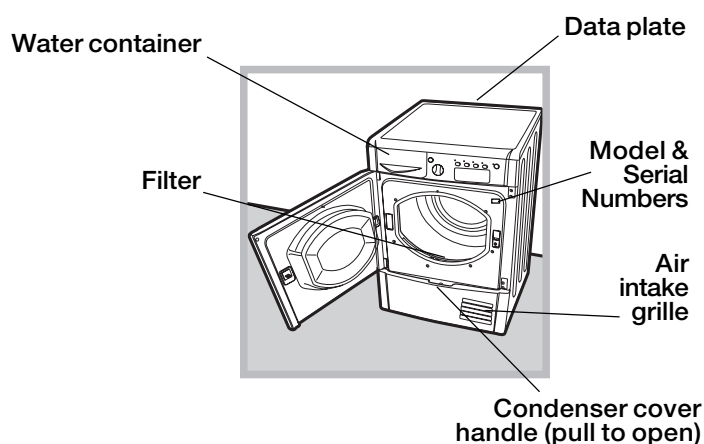

Control panel

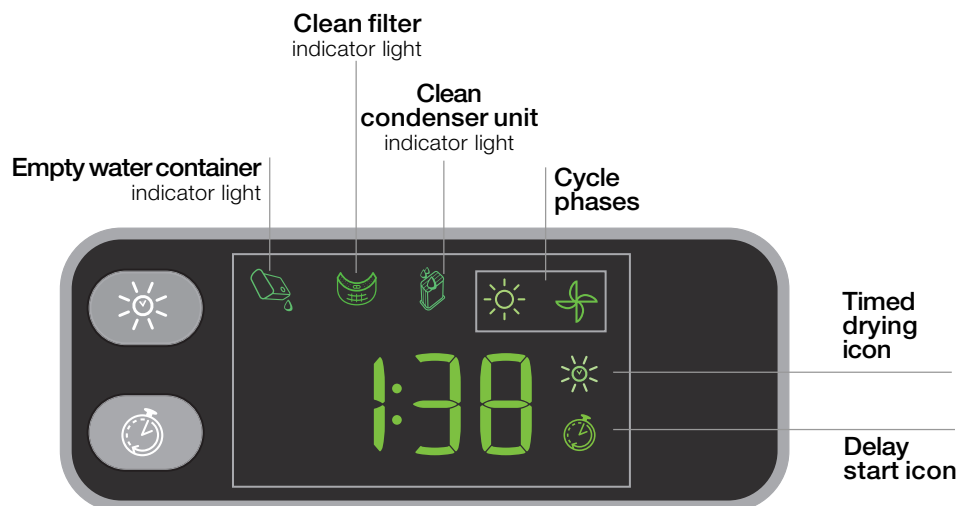
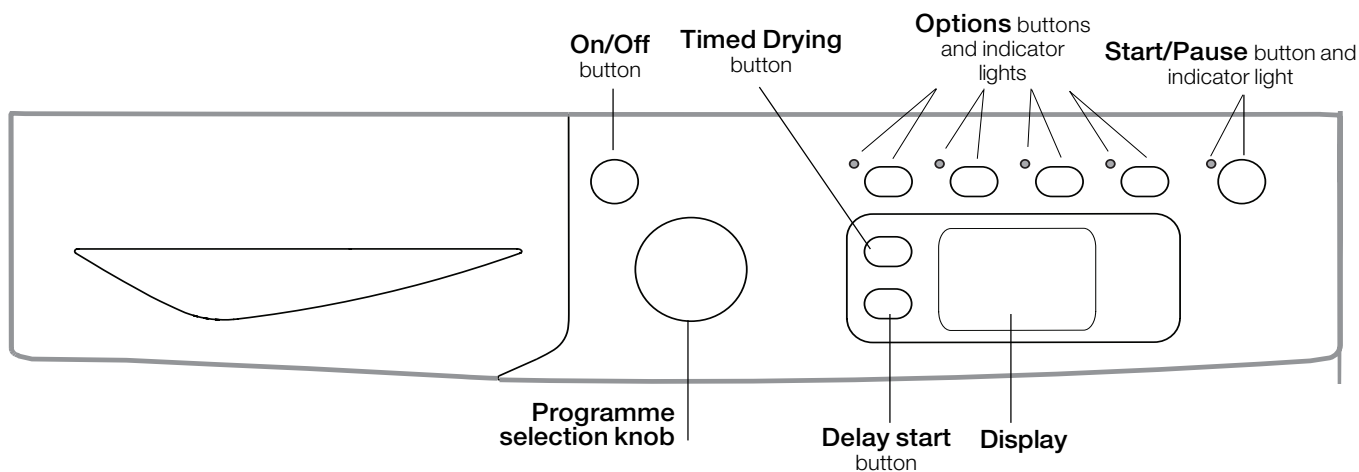

ON/OFF/Reset button

Pressing the button normally will cause the machine to switch on or off. If the button is pressed for 3 seconds while the dryer is in function, the machine will switch off and the running cycle will reset.

Programme selection knob

Allows for setting the programme: turn until the indicator points towards the desired programme (see *Starting and selecting a programme*).

Options buttons

Allows for selecting the options available for the selected programme. The relative indicator lights turn on when the option has been selected (see *Programmes and options*).

START/PAUSE button and indicator light

When the green light flashes slowly, press the button to start the programme. When the cycle is under way, the indicator light remains on. Press the button again to put the programme in the pause mode; the indicator light turns orange and starts flashing again. Press the button again to resume the programme from the point it was interrupted (see *Starting and selecting a programme*).

Display

In section **A**, the selected “Timed drying” value is displayed; if the “Delay start” function was set, the time remaining to the start of the selected programme will appear.

The duration of the selected programme is also displayed in this section.

In section **B**, the phase of the running programme is displayed:

Sun icon ☀️: Drying cycle

Fan icon 🌀: Cold air cycle

In section **C**, the maintenance indicator lights are displayed (Empty water container indicator light 🚰, Clean filter indicator light 🌀, Clean condenser unit indicator light 🧼, see *Indicator lights*).

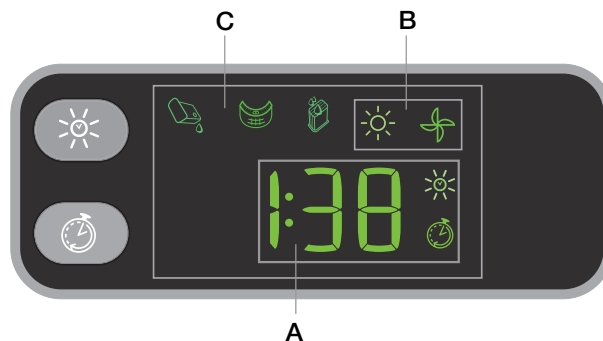

Indicator lights

The indicator lights provide important information. They indicate the following:

The “Empty water container” indicator light 🚰 signals that the water container must be emptied.

If the water container fills during the course of the programme, the LED lights up. The dryer automatically starts a cold air cycle and the START/PAUSE LED flashes orange. Press the START/PAUSE button to resume the cycle from the point it was interrupted.

In order to avoid this procedure, always empty the water container after using the tumble dryer (see *Maintenance*).

Before each programme, the “Clean filter” indicator light 🌀 signals the fundamental importance of cleaning the filter before each load (see *Maintenance*).

The “Clean condenser unit” indicator light 🧼 signals the fundamental importance of cleaning the condenser regularly (see *Maintenance*).

How to carry out a drying cycle



Starting and selecting a programme

1. Plug the dryer into the power supply socket.
2. Select the programme according to the type of laundry (see *Laundry*).
3. Open the door, ensure that the filter is clean and securely placed and that the water container is empty and correctly slotted (see *Maintenance*).
4. Load the machine, making sure that no piece of laundry gets between the door and the relative seal. Close the door.
5. Press the ON/OFF button to start the machine.
6. After consulting the programme chart and the indications for each type of fabric (see *Linen*), turn the Programme selection knob towards the programme corresponding to the type of laundry to be dried (see *Programmes and options*).
Warning: If the position of the programme selection knob changes after pressing the START/PAUSE button, the selected programme will NOT be modified. To modify the programme, press the START/PAUSE button to put the programme in pause mode (the indicator light flashes orange), then select a new programme and the relative options. Press the START/PAUSE button to start the new programme.
7. Select the "Timed Drying" function by pressing the relative button until reaching the desired level or time (see *Programmes and options*).
8. If necessary, set the time of the delayed start and any other options (see *Programmes and options*).
9. Press the ALARM  button to sound a buzzer signalling the end of the programme.
10. Press the START/PAUSE button to start the drying cycle. The display will visualise the approximate time remaining. Laundry can be checked while the drying programme runs and any garments already dry can be removed, while drying continues for the remaining items. After closing the door, press the START/PAUSE button to resume machine operation.
11. The final COLD DRYING phase (i.e. the fabrics are cooled) activates during the last few minutes of the drying programme; always allow this phase to terminate.
12. A buzzer signals when the programme ends (provided the relative option was selected). The word "**End**" will appear on the display. Open the door, remove the laundry then clean the filter and replace it. Empty the water container and put it back in its slot (see *Maintenance*).
If the "Post anti-crease" option was selected and laundry is not removed immediately, the drum will rotate garments at intervals for 10 hours or until the door is opened.
13. Disconnect the dryer from the power supply.

Programmes and options

EN

Programme chart

	Programme	Max. load (kg)	Compatible options	Cycle duration	
Daily					
1	Ready to Wear	Max.	Alarm – Pre anti-crease – Post anti-crease – High heat – Timed drying – Delay start	The duration of the wash cycles can be monitored on the display.	
2	Cotton Cupboard dry	Max.	Alarm – Pre anti-crease – Post anti-crease – High heat – Timed drying – Delay start		
3	Cotton Hanger dry	Max.	Alarm – Pre anti-crease – Post anti-crease – High heat – Timed drying – Delay start		
4	Cotton Iron dry	Max.	Alarm – Pre anti-crease – Post anti-crease – High heat – Timed drying – Delay start		
5	Synthetics Cupboard dry	3	Alarm – Pre anti-crease – Post anti-crease – High heat – Timed drying – Delay start		
6	Synthetics Iron dry	3	Alarm – Pre anti-crease – Post anti-crease – High heat – Timed drying – Delay start		
Special					
7	Eco Time	2	Alarm – Pre anti-crease – Post anti-crease – Delay start		
8	Wool	1	Alarm		
9	Silk	0,5	Alarm – Pre anti-crease – Post anti-crease – Delay start		
10	Jeans	3	Alarm – Pre anti-crease – Post anti-crease – Delay start		
11	Outwear	2	Alarm – Pre anti-crease – Post anti-crease – Delay start		
Sport					
12	Sport Intensive	4	Alarm – Pre anti-crease – Post anti-crease – Delay start		
13	Sport Light	4	Alarm – Pre anti-crease – Post anti-crease – Delay start		
14	Special Shoes	2 pairs	Alarm		
Partial					
	Easy iron	2,5	Alarm		
	Refresh	-	Alarm		

Special/Sport/Partial Programmes

Eco Time Programme *EcoTime*

This programme is ideal for safely drying small loads in a short time, thereby optimising energy consumption. Suitable for loads of up to **2 kg**, it lasts about **1:00** (hrs:mins). The programme may last longer depending on the size and density of the load and on the spin speed used during the wash cycle

We recommend checking whether garments are labelled with the  symbol and to turn them inside out before drying them.

Wool Programme

This programme is specific for items that withstand tumble drying and are labelled with the  symbol. It is suitable for loads of up to **1 kg** (about 3 jerseys). We recommend turning the garments inside out before drying them. This programme lasts about **1:00** (hrs:mins), although it may last longer depending on the size and density of the load and on the spin speed used during the wash cycle. Garments dried with this programme are usually ready to be worn, although the edges of heavier garments may be slightly damp. Leave them to dry naturally, as an additional drying process may damage them.

Unlike other materials, the shrinking process in wool is irreversible, i.e. the garment does not resume its original dimension and shape.

This programme is not suited for acrylic items.

Silk Programme

This programme is specifically intended for drying delicate silk garments. It can be used for loads of up to **0.5 kg**.

This programme lasts about **1:50** (hrs:mins), although it may last longer depending on the size and density of the load and on the spin speed used during the wash cycle. Garments dried with this programme are usually ready to be worn, although the edges of heavier garments may be slightly damp. If this occurs, remove the load, open the garments and reactivate the programme for a short while.

Only for garments bearing the tumble dry symbol on the care label.

Jeans Programme

This programme is suited to washing cotton denim jeans. Turn the front pockets inside out before drying the jeans. It is suitable for loads of up to **3 kg** (about 4 pairs).

This programme lasts about **1:25** (hrs:mins), although it may last longer depending on the size and of the load and on the spin speed used in the wash cycle. Garments dried using this programme are usually ready to be worn, though edges and seams may be slightly damp. In this occurs, turn the jeans inside out and reactivate the programme for a short while.

Use this cycle for 100% cotton garments only; do not mix dark and light colours and avoid using this programme for garments with embroidery and accessories (elastic strings around the waist area, brooches, etc.); turn pockets inside out.

Outwear Programme

This programme is specific for drying water-repellent fabrics and sports jackets (e.g. Gore-Tex, polyester, nylon). Drying the garment after a wash cycle has a beneficial effect as it reactivates the garment's water-repellent treatment.

It can be used for loads of up to **2 kg**. The programme lasts about **2:00** (hrs:mins), although it may last longer depending on the size and density of the load and on the spin speed used during the wash cycle.

Sport Intensive Programme

This programme is studied for safely drying garments such as tracksuits and shorts bearing the  symbol. It is ideal for clothes which do not need to be dried fully. Suitable for loads of up to **4 kg**, it lasts about **1:20** (hrs:mins), although it may last longer depending on the size and density of the load and of the spin speed used during the wash cycle. We suggest turning garments inside out before drying them.

Sport Light Programme

This programme is studied for safely drying garments such as tracksuits and shorts bearing the  symbol. It is ideal for those garments that do not need to be dried fully or which have to be ironed. Suitable for loads of up to **4 kg**, it lasts about **1:10** (hrs:mins), although it may last longer depending on the size and density of the load and of the spin speed used during the washing cycle. We suggest turning garments inside out before drying them.

Special Shoes Programme

This programme is specific for drying sports shoes of sizes **37-46**. The shoes must have been previously washed and spun at a minimum spin speed of **400 revolutions**.

A specific shoe rack is provided and must be used, otherwise the dryer will be damaged if shoes are dried in the drum. Remove the filter from its holder on the front part of the dryer and position the shoe rack.

Place shoelaces inside the shoes then load with the tips of the shoes facing downwards and the soles frontwards.

Drying times vary according to the shape and type of the shoe. If the shoes are not completely dry at the end of the programme, restart the programme.

Do not dry shoes that have gel or flashing lights inside them. Only dry shoes made of synthetic material or rope. Once the programme ends, remove the shoe rack and replace the filter into its holder.

Easy Iron

A short 10-minute programme that relaxes the garment's fibres in order to facilitate ironing and folding.

This programme is particularly recommended for cotton or mixed cotton fabrics.

For optimal results, do not overload the drum (the following values refer to the weight of dry garments):

Fabric: maximum load

Cotton and mixed cotton: **2.5 kg**

Synthetic garments: **2 kg**

Jeans: **2 kg**

Empty the dryer as soon as the programme ends; hang, fold or iron garments then place them in the wardrobe. If this is not possible, repeat the programme.

As this is not a drying programme, it is not to be used for garments that are still wet.

The effect produced by the programme varies according to the characteristics of the each fabric: fabrics such as acrylic fibres or Tencel® do not give the same results as traditional fibres (e.g. cotton).

Refresh

A short programme suitable for refreshing fibres and garments through the emission of cool air. It lasts about **0:20** (hrs:mins).

As this is not a drying programme, it is not to be used for garments that are still wet.

Options

The options allow for customising the selected programme according to one's own needs.

Timed drying

After selecting a programme, press the "Timed drying" button to enter a drying time. Every time this button is pressed, the duration of the selected drying cycle appears on the display. When pressed the first time, the highest allowed value for the selected cycle appears on the display. When pressed each of the following times, the set time is reduced until **OFF** appears.

Three buzzer signals are emitted if the timed drying option is not available.

The selected time remains visualised after the start of the programme and cannot be modified after pressing the START/PAUSE button.

Delay Start

The start of some programmes (see *Programmes and options*) may be delayed up to **24** hours. Press the button repeatedly to enter the desired delay time. Before setting a delayed start, make sure that the water container is empty and that the filter is clean.

Pre Anti-Crease

When this option is selected in addition to the "Delay start" option, the drum rotates garments at intervals during the delay period to avoid creases forming.

Post Anti-Crease

When this option is selected, the drum rotates garments at intervals after the cold drying cycle has ended, in order to avoid creases forming on garments if they cannot be immediately removed at the end of the programme. During this phase, the indicator light is turned on.

High Heat

When a drying time is selected, pressing this button sets a high heat drying and the indicator light above the button lights up. The timed programmes are pre-set to low heat.

Alarm

A buzzer sounds at the end of the drying cycle to signal that the programme has ended and the garments are ready to be removed.

Not all options are available on all programmes (see *Programmes and options*). If the button of an unavailable option is pressed, the buzzer emits three signals. If an option is available, a single buzzer signal sounds and the option indicator light next to the button lights up to confirm the selected option.

Opening the door

If the door is opened (or the START/PAUSE button is pressed) while a programme is running, the dryer stops and the following may occur:

- The START/PAUSE button flashes orange.
- When a delayed start is running, the delay countdown continues. It is necessary to press the START/PAUSE button to resume the "Delay start" programme. The "Delay start" indicator light flashes and the display visualises the time remaining to the start of the selected programme.
- It is necessary to press the START/PAUSE button to resume the programme. The progress indicator lights signal the running phase and the START/PAUSE indicator light stops flashing and turns green.
- During the post anti-crease phase, the programme ends. Pressing the START/PAUSE button reactivates a new programme from the beginning.
- By turning the Programme selection knob, a new programme is selected and the START/PAUSE indicator light flashes green. This procedure can be used to select the Cold drying programme to cool garments if they are judged to be dry enough. Press the START/PAUSE button to start the new programme.

Note: In the event of a power cut, turn the power switch off and remove the plug; when the electricity supply returns, press the START/PAUSE button to resume the programme.

Sorting laundry

- Check the symbols on the care labels of the various garments to verify whether the garments can be safely tumble dried.
- Sort laundry according to the type of fabric.
- Empty all pockets and check for loose buttons.
- Close zips and hooks and fasten belts and strings without tightening them.
- Wring out garments to remove the maximum amount of water possible.

! Do not load the dryer when garments are dripping wet.

Maximum load sizes

Do not overload the drum.

The following values indicate the weight of dry garments:

Natural fibres: maximum **7.5 kg**

Synthetic fibres: maximum **3 kg**

! Do not overload the dryer as this may result in reduced drying performance.

Typical weights

Note: 1 kg = 1000 g

Garments		
Blouse	Cotton	150 g
	Other	100 g
Dress	Cotton	500 g
	Other	350 g
Jeans		700 g
10 nappies		1,000 g
Shirt	Cotton	300 g
	Other	200 g
T-shirt		125 g





Household linen		
Duvet cover (double bed)	Cotton	1,500 g
	Other	1,000 g
Large tablecloth		700 g
Small tablecloth		250 g
Tea cloth		100 g
Bath towel		700 g
Hand towel		350 g
Double bed sheet		500 g
Single bed sheet		350 g

When mixing synthetic fibres with cotton garments, the latter may still be damp at the end of the drying cycle. If this happens, simply put them through a short drying cycle.

Note: when setting the duration of the drying cycle, remember that the cold drying phase runs during the last 10 minutes, during which the dryer does not dry the garments.

Care labels

Always check the care labels, especially when placing garments in the tumble dryer for the first time. Below are the most commonly used symbols:

-  May be tumble dried.
-  Do not tumble dry.
-  Tumble dry – high heat.
-  Tumble dry – low heat.

Items not suitable for tumble drying:

- Items containing rubber parts or similar materials, or plastic film covering (pillows, cushions or PVC sports jackets), any type of inflammable object or objects containing inflammable substances (used towels containing hairspray).
- Glass fibres (certain types of draperies).
- Items which have been previously dry cleaned.
- Items marked with the ITLC symbol ("Special garments") , which may be washed using special household products. Follow instructions carefully.
- Large bulky items (duvets, sleeping bags, pillows, cushions, large bedcovers, etc.) that expand when dried and hamper air circulation inside the tumble dryer.

Special garments

Blankets and bedcovers: acrylic items (Acilian, Courtelle, Orion, Dralon) must be dried with great care at low heat. Avoid drying for long periods.

Creased or pleated garments: read the drying instructions supplied by the manufacturer.

Starched garments: do not dry together with non-starched items. Remove the maximum amount of starch solution possible before placing these items in the dryer. Do not over-dry: starch turns powdery leaving garments limp – this defeats its purpose.

Drying times

Drying times are approximate and may vary depending on the following:

- Amount of water retained by items after the spin cycle: towels and delicate items retain a lot of water.
- Fabrics: items of the same fabric, but with different texture and thickness may have different drying times.
- Amount of laundry: single items and small loads may take longer to dry.
- Drying: if items are to be ironed, they can be removed from the dryer while still slightly damp. Items that require complete drying can be left longer.

- Heat setting.
- Temperature of the room: the lower the temperature of the room, the longer it will take for the dryer to dry clothing.
- Bulk: certain bulky items require special care during the drying process. We suggest removing these items and replacing them in the dryer once they have been shaken out: repeat this procedure several times during the course of the drying cycle.

! Do not over-dry items.

All fabrics contain natural dampness which helps to keep them soft and fluffy.

The drying times provided refer to the automatic Cupboard dry programmes.

The Timed drying settings are also indicated to enable you to select the most suitable timed option.

The weight refers to dry items.

Drying times

Cotton								
Intensive drying								
Drying times after 800-1000 rpm wash cycles								
	1 kg	2 kg	Half load 3 kg	4 kg	5 kg	6 kg	7 kg	Full load 7.5 kg
Automatic (hrs:mins)	0:30-0:50	0:50-1:10	1:10-1:20	1:20-1:40	1:40-2:00	2:00-2:20	2:20-2:30	2:10-2:50
Timed (hrs:mins)	0:30 or 1:00	1:00 or 1:30	1:00 or 1:30	1:30 or 2:00	1:30 or 2:00	2:20 or 2:40	2:20 or 2:40	2:20 or 3:00
Synthetics								
Intensive drying								
Drying times after wash cycles at lower speeds								
	1 kg		Half load 2 kg		Full load 3 kg			
Automatic (hrs:mins)	0:30 - 0:40		0:40 - 0:50		0:50 - 1:10			
Timed (hrs:mins)	0:30 or 1:00		0:30 or 1:00		1:00 or 1:30			
Delicates								
Normal drying								
Drying times after wash cycles at lower speeds								
	Half load 1 kg				Full load 2 kg			
Automatic (hrs:mins)	0:40 - 1:20				1:20 - 2:20			
Timed (hrs:mins)	0:30 or 1:00 or 1:30				1:00 or 1:30 or 2:00			

Warnings and suggestions

! This appliance was designed and manufactured in compliance with current international safety standards. The following information is provided for safety reasons and must be read carefully.

General safety

- This tumble dryer must not be used by persons (including children) with physical, sensory or mental impairments or with little experience and knowledge of the appliance, unless they are supervised or have been adequately instructed on its use by the person responsible for their safety.
- This tumble dryer is designed for domestic and non-professional use.
- Do not touch the appliance while barefoot or with wet hands or feet.
- Unplug the appliance by pulling on the plug, not the cord.
- Do not allow children near the appliance while it is in function. After use, switch the appliance off and unplug it. Keep the appliance door closed to prevent children using it as a toy.
- Children must be supervised to ensure that they do not play with the appliance.
- The appliance must be correctly installed and receive adequate ventilation. The air intake on the front part of the dryer and the air vents on the rear must never be obstructed (see *Installation*).
- Never use the dryer on carpeting with high pile as this may prevent air from entering the dryer from the base.
- Check whether the dryer is empty before loading it.
-  The rear part of the dryer may become very hot: do not touch it while the appliance is in function.
- Do not use the dryer unless the filter, water container and condenser are properly positioned (see *Maintenance*).
- Do not use liquid fabric softener in the dryer; add it to the final rinse of the wash cycle.
- Do not overload the dryer (see *Laundry for the maximum load sizes*).
- Do not add items that are dripping wet.
- Tumble dry items only if they have been washed with water and detergent, and have been rinsed and put through a spin cycle. Drying items that have NOT been washed with water may cause the risk of fire.
- Always read the instructions on the care label carefully (see *Laundry*).
- Do not tumble dry items that have been treated with chemical products.
- Never tumble dry items that are contaminated with inflammable substances (cooking oil, acetone, alcohol, petrol, kerosene, stain removers, turpentine, waxes, wax removers and hairspray), unless they have been washed in hot water with an extra amount of detergent.
- Do not tumble dry rubber, rubber-backed articles and garments, cushions with foam rubber padding, latex foam, rubber, plastic, shower caps, water-resistant fabrics, nappy pants or liners, polyethylene and paper.
- Remove all objects from pockets, particularly lighters (risk of explosion).
- Do not tumble dry large, excessively bulky items.
- Do not tumble dry acrylic fibres at high temperatures.

- Complete each programme with the relative cold drying phase.
- Do not switch the tumble dryer off if items that are still warm are inside it.
- Clean the filter after each use (see *Maintenance*).
- Empty the water container and put it back in place after each use (see *Maintenance*).
- Clean the condenser unit regularly (see *Maintenance*).
- Do not allow lint to build up around the tumble dryer.
- Avoid climbing on the top of the dryer as this may damage the appliance.
- Always comply with electrical regulations and requirements (see *Installation*).
- Always purchase original accessories and spare parts (see *Assistance*).

! **WARNING:** Never stop the dryer before the end of the drying cycle unless all items have been quickly removed and hung in order to dispel heat.

Information on recycling and disposal

As part of our continual commitment towards environmental protection, we reserve the right to use recycled quality components to reduce costs for our customers and to minimise materials wastage.

- Disposing of the packaging materials: follow local regulations to allow for recycling of packaging materials.
- In order to minimise the risk of injury to children, remove the door and plug, then cut the power supply cord flush with the appliance. Dispose of these parts separately to prevent the appliance from being connected to a power supply socket.

Disposal of old household appliances

 European Directive 2002/96/EC concerning Waste Electrical and Electronic Equipment (WEEE) states that household appliances should not be disposed of using the normal solid urban waste cycle. Exhausted appliances should be collected separately in order to optimise the cost of re-using and recycling materials comprising the machine, while preventing potential damage to public health and the environment. The crossed-out wheeled bin symbol appears on all products to remind owners of the obligations regarding separate waste collection.

Owners should contact their local authorities or appliance dealers for further information concerning the correct disposal of household appliances.

Saving energy and respecting the environment

- Wring out items before tumble drying them to remove the maximum amount of water possible (if they are previously washed in a washing machine, select a spin cycle). This ensures that energy is saved during tumble drying.
- Always use the tumble dryer at full load to save energy: single items and small loads may take longer to dry.
- Clean the filter at the end of each cycle to reduce energy consumption costs (see *Maintenance*).

Care and maintenance

EN

Disconnecting the power supply

! Disconnect the dryer when not in use or during cleaning and maintenance operations.

Cleaning the filter after each cycle

The filter is a fundamental component of the dryer: its function is to collect lint and fluff that form during drying. Clean the filter once drying is completed, by rinsing it under running water or cleaning it with a vacuum cleaner. Should the filter become clogged, the flow of air inside the dryer will be seriously hampered: drying times becomes longer and more energy is consumed. Moreover, the dryer may become damaged.

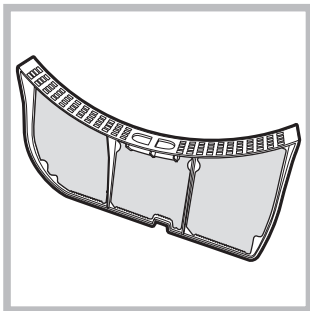

The filter is located in front of the dryer seal (see Picture).

Removing the filter:

1. Pull the filter's plastic handle upwards (see Picture).
2. Clean the fluff off the filter and replace it correctly. Ensure that the filter is placed flush with the dryer seal.

! Do not use the dryer unless the filter has been replaced in its holder.

Checking the drum after each cycle

Rotate the drum manually to remove smaller items (handkerchiefs) that could have been left inside the dryer.

Cleaning the drum

! Avoid using abrasives, steel wool or stainless steel cleaning agents to clean the drum.

A coloured film may appear on the stainless steel drum surface: it may be caused by a combination of water and/or cleaning agents such as wash-softeners. This coloured film does not affect the dryer's performance.

Emptying the water container after each cycle

Remove the water container and empty it into a sink or other suitable drain outlet, then replace it correctly. Always check the water container and empty it before starting a new drying cycle.

Cleaning the condenser unit

- Remove the condenser unit regularly (monthly) and clean off any fluff deposits from the plates by rinsing it with cold water running on the rear end of the condenser.

Removing the condenser:

1. Disconnect the dryer from the power supply and open the door.
2. Open the condenser cover (see Picture), unlock the three catches by turning them 90° anti-clockwise, then pull on the grip to remove the condenser.
3. Clean the surface of the seals and replace the unit with the arrows pointing upwards, while making sure that the catches are securely fixed.

Cleaning the tumble dryer

- The external metal and plastic parts and the rubber parts can be cleaned with the aid of a damp cloth.
- Clean the front air intake grille regularly (every 6 months) with a vacuum cleaner to remove any lint, fluff or dust deposits. Furthermore, remove any lint deposits from the front part of the condenser and from the filter area, using a vacuum cleaner every so often.

! Do not use solvents or abrasives.

! The dryer uses ball bearing components that do not require lubrication.

! Have the dryer checked regularly by authorised technical personnel in order to ensure that the electrical and mechanical parts work safely (see Assistance).

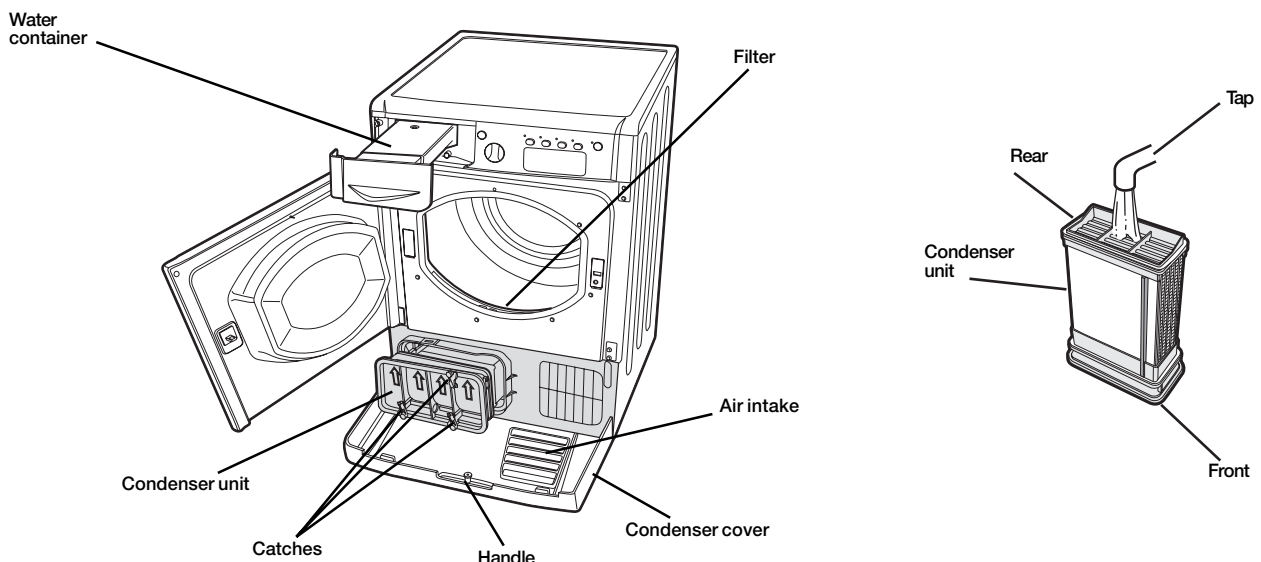

If you feel that the dryer is not working properly, consult the following troubleshooting suggestions before contacting the Technical Assistance Centre (see *Assistance*).

Problem:**Possible causes / Solutions:****The dryer does not start.**

- The plug has not been inserted far enough into the socket to make contact.
- There has been a power cut.
- The fuse has burned out. Try connecting another appliance to the same socket.
- If an extension cord is used, try connecting the dryer plug directly into the socket.
- The door has not been closed properly.
- The programme has not been set correctly (see *How to carry out a drying cycle*).
- The START/PAUSE button has not been pressed (see *How to carry out a drying cycle*).

The drying cycle does not start.

- A delayed start time has been set (see *Programmes and options*).
- The START/PAUSE button has been pressed; a short delay follows before the dryer starts running. Wait for the drying cycle to start; do not press the START/PAUSE button otherwise the dryer switches to the pause mode and the drying cycle will not start.

Drying times are too long.

- The filter has not been cleaned (see *Maintenance*).
- The water container must be emptied? The "Empty water container" indicator light flashes and the message appears **"H2O"** (see *Maintenance*).
- The condenser needs to be cleaned (see *Maintenance*).
- The heat setting is not suited to the type of fabric to be dried (see *Programmes and options*).
- An incorrect drying time was selected for the type of load (see *Laundry*).
- The items are too wet (see *Laundry*).
- The air intake grille are clogged up (see *"Installation" and "Care and Maintenance"*).
- The dryer is overloaded (see *Laundry*).

The "Empty water container" indicator light flashes, but the dryer has been running for a short time.

- The water container was probably not emptied before starting the programme. Do not wait for the signal for emptying the water container, but always check and empty it before starting a new drying programme (see *Description of the tumble dryer*).

The "Empty water container" indicator light is on but the water container is not full.

- It is normal: the "Empty water container" indicator light flashes when the water container is full. If the indicator light is on but is not flashing, it only signals that the water container must be emptied (see *Description of the tumble dryer*).

The programme is finished but the items are damper than expected.

- ! For safety reasons, the dryer programmes last a maximum of 4 hours. If an automatic programme has not detected the final dampness level required in this interval, the dryer completes the programme and stops. Check the above points and repeat the programme; if the items are still damp, contact the Technical Assistance Centre (see *Assistance*).

The code "F" appears on the display followed by one or two numbers, the options indicator lights and the pause indicator light flash.

- If the display visualises F10 or F15, switch the appliance off and unplug it, then clean the filter and the condenser (see *Maintenance*). Reinsert the plug, switch the appliance on and start another programme. If the display still visualises F10 or F15, contact the Technical Assistance Centre (see *Assistance*). If the display still visualises other numbers, mark the code and contact the Technical Assistance Centre (see *Assistance*).

"dOn" briefly appears on the display every 6 seconds.

- The appliance is in "Demo" mode. Press the ON/OFF and START/PAUSE buttons and keep them pressed for 3 seconds. The display visualises **"dOn"** for 3 seconds, then the dryer starts functioning normally.

The "Remaining time" indicator changes during the drying cycle.

- The remaining time is constantly monitored during the drying cycle and is updated to show the best forecast. It is normal for the displayed time to increase during the cycle.

The dryer is noisy during the first few minutes of operation.

- This is normal, especially if the dryer has not been used for a long time. If the noise persists during the entire cycle, contact the Technical Assistance Centre.

Assistance

EN

Before calling the Technical Assistance Centre:

- Follow the troubleshooting guide to check whether problems can be solved personally (see *Troubleshooting*).
- If not, switch the dryer off and contact the Technical Assistance Centre closest to you.

Provide the following data when contacting the Technical Assistance Centre:

- name, address and postal code
- telephone number
- type of malfunction
- date of purchase
- the appliance model (Mod.)
- the dryer's serial number (S/N)

This information can be found on the data plate located behind the door.

Comparative programmes

- recommended programmes for the EN61121 comparative test.

Programme (EN61121)	Programme to be selected	Load size
Cotton drying cycle	Cotton Cupboard dry	7.5 kg
Cotton drying ironing	Cotton Iron dry	7.5 kg
Easy care fabric	Synthetic Cupboard dry	3 kg

! Note: this is not a complete list of the programme options (see *Starting and selecting a programme*).



This appliance conforms to the following EEC directives:

- 2006/95/EC (Low Voltage Directive)
- 89/336/EEC, 92/31/EEC, 93/68/EEC (Electromagnetic Compatibility Directive).

12 Months Parts and Labour Guarantee

Your appliance has the benefit of our manufacturer's guarantee, which covers the cost of breakdown repairs for twelve months from the date of purchase.

EN

This gives you the reassurance that if, within that time, your appliance is proven to be defective because of either workmanship or materials, we will, at our discretion, either repair or replace the appliance at no cost to you.

This guarantee is subject to the following conditions:

- The appliance has been installed and operated correctly and in accordance with our operating and maintenance instructions.
- The appliance is used only on the electricity or gas supply printed on the rating plate.
- The appliance has been used for normal domestic purposes only.
- The appliance has not been altered, serviced, maintained, dismantled, or otherwise interfered with by any person not authorised by us.
- Any repair work must be undertaken by us or our appointed agent.
- Any parts removed during repair work or any appliance that is replaced become our property.
- The appliance is used in the United Kingdom or Republic of Ireland.

The guarantee does not cover:

- Damage resulting from transportation, improper use, neglect or interference or as a result of improper installation.
- Replacement of any consumable item or accessory. These include but are not limited to: plugs, cables, batteries, light bulbs, fluorescent tubes and starters, covers and filters.
- Replacement of any removable parts made of glass or plastic.

THIS GUARANTEE WILL NOT APPLY IF THE APPLIANCE HAS BEEN USED IN COMMERCIAL OR NON-DOMESTIC PREMISES.

5 Year Parts Guarantee

Indesit also offers you a free 5 year parts guarantee. This additional guarantee is conditional on you registering your appliance with us and the parts being fitted by one of our authorised engineers. There will be a charge for our engineer's time. To activate the extra parts warranty on your appliance, simply call our registration line on **08448 24 24 24** (Republic of Ireland 01 230 0800)

Extended Guarantees

We offer a selection of repair protection plans that enable you to fully cover yourself against the expense of repair bills for the life of your policy. To find the ideal plan for you please call our advice line on **08448 226 226** (Republic of Ireland 01 230 0233).

Free Helpdesk Service

We have a dedicated team who can provide free advice and assistance with your appliance if you experience any technical difficulties within the first 90 days of ownership. Simply call our Indesit Service Hotline on **08448 224 224** (Republic of Ireland 0818 313 413) for telephone assistance, or, where necessary, to arrange for an engineer to call.

After Sales Service

No one is better placed to care for your Indesit appliance during the course of its working life than us - the manufacturer.

Essential Contact Information

Indesit Service

We are the largest service team in Europe offering you access to 400 skilled telephone advisors and 1100 fully qualified engineers on call to ensure you receive fast, reliable, local service.

UK: 08448 224 224

Republic of Ireland: 0818 313 413

www.indesitservice.co.uk

Please note: Our advisors will require the following information:

Model number:

Serial number:

Parts and Accessories

We supply a full range of genuine replacement parts as well as accessory products that protect and hygienically clean your appliance to keep it looking good and functioning efficiently throughout its life.

UK: 08448 225 225

Republic of Ireland: 0818 313 413

www.indesitservice.co.uk

Appliance Registration

We want to give you additional benefits of Indesit ownership. To activate your free 5 year parts guarantee you must register your appliance with us.

UK: 08448 24 24

Republic of Ireland: 01 230 0800

www.indesitservice.co.uk

Indesit Company UK Ltd. Morley Way, Peterborough, PE2 9JB

Indesit Company Unit 49 Airways Industrial Estate, Dublin 17



Recycling & Disposal Information

As part of Indesit's continued commitment to helping the environment, Indesit reserves the right to use quality, recycled components to keep down customer costs and minimise material wastage.

Please dispose of packaging and old appliances carefully. To minimise the risk of injury to children, remove the door, plug and cut the mains cable off flush with the appliance. Dispose of these parts separately to ensure that the appliance can no longer be plugged into a mains socket, and the door cannot be locked shut.



195075237.00

01/2009 - Xerox Fabriano

EN

Free Manuals Download Website

<http://myh66.com>

<http://usermanuals.us>

<http://www.somanuals.com>

<http://www.4manuals.cc>

<http://www.manual-lib.com>

<http://www.404manual.com>

<http://www.luxmanual.com>

<http://aubethermostatmanual.com>

Golf course search by state

<http://golfingnear.com>

Email search by domain

<http://emailbydomain.com>

Auto manuals search

<http://auto.somanuals.com>

TV manuals search

<http://tv.somanuals.com>