

Operating Instructions

COOKER

GB

English, 1

IS50G
IS50G1

GB

Contents

Installation, 2-6

Positioning and levelling
Electrical connections
Gas connection
Adapting to different types of gas
Technical data
Table of burner and nozzle specifications

Description of the appliance, 7

Overall view
Control panel

Start-up and use, 8-10

Using the hob
Using the oven
Analogue timer
Oven cooking advice table

Precautions and tips, 11

General safety
Disposal
Respecting and conserving the environment

Maintenance and care, 12

Switching the appliance off
Cleaning the appliance
Gas tap maintenance
Replacing the oven light bulb
Assistance

You must read these instructions prior to using your appliance and retain them for future use.

 **INDESIT**

Installation

GB

! Before operating your new appliance please read this instruction booklet carefully. It contains important information concerning the safe installation and operation of the appliance.

! Please keep these operating instructions for future reference. Make sure that the instructions are kept with the appliance if it is sold, given away or moved.

! The appliance must be installed by a qualified professional according to the instructions provided.

! Any necessary adjustment or maintenance must be performed after the cooker has been disconnected from the electricity supply.

Positioning

! This unit may be installed and used only in permanently ventilated rooms according to the British Standards Codes Of Practice: B.S. 6172/B.S. 5440, Par. 2 and B.S. 6891 Current Editions. The following requirements must be observed:

- The cooker should not be installed in a bed sitting room with a volume of less than 20m^3 . If it is installed in a room of volume less than 5m^3 an air vent of effective area of 110cm^2 is required, if it is installed in a room of volume between 5m^3 and 10m^3 a supplementary airvent area of 50cm^2 is required, if the volume exceeds 11m^3 no airvent is required. However, if the room has a door or a window which opens directly to the outside no air vent is required even when the volume is between 5m^3 and 11m^3 .
- During prolonged use of the appliance you may consider it necessary to open a window to the outside to improve ventilation.
- If there are other fuel burning appliances in the same room, B.S.5440 Part 2 Current Edition, should, be consulted to determine the requisite air vent requirements.

Levelling

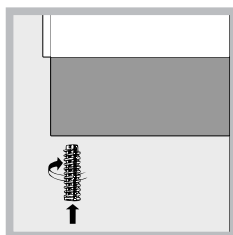

If it is necessary to level the appliance, screw the adjustable feet into the places provided on each corner of the base of the cooker (see figure).

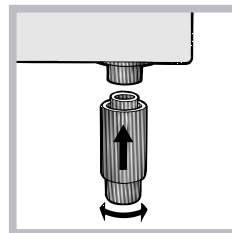

The legs* fit into the slots on the underside of the base of the cooker.

Installation of the cooker

The appliance can be installed next to furniture units which are no taller than the top of the cooker hob. The wall in direct contact with the back panel of the cooker must be made of non-flammable material. During operation the back panel of the cooker could reach a temperature of 50°C above room temperature. For proper installation of the cooker, the following precautions must be taken:

- The appliance can be placed in a kitchen, dining room or bedsit, but not in a bathroom.
- All furniture around the appliance must be placed at least 200 mm from the top of the cooker, should the surface of the appliance be higher than the worktop of this furniture. Curtains should not be placed behind the cooker or less than 200 mm away from the sides of the appliance.
- Any hoods must be installed according to the requirements in the installation manual for the hoods themselves.
- If the cooker is installed beneath a wall cabinet, the latter must be situated at a minimum of 420 mm above the hob. The minimum distance between the worktop and kitchen units made of combustible material is 700 mm (Fig. A).
- The wall in direct contact with the back panel of the cooker must be made of non-flammable materials.
- The cooker is fitted with a safety chain that must be attached to a hook, secured to the wall behind the appliance.

! Some models can have their gas connection inverted. It is important to make sure the safety chain is always situated on the side which corresponds to the hose holder (Fig. B).

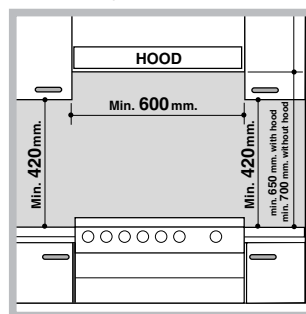

Fig. A

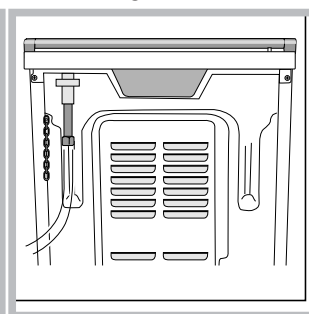
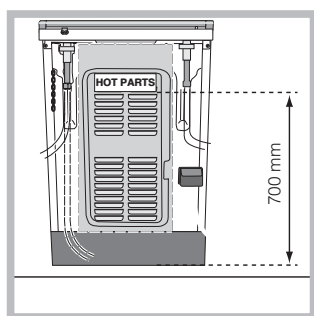

Fig. B

Gas connection

The cooker should be connected to the gas-supply by a Gas Safe registered installer. During installation of this product it is essential to fit an approved gas tap to isolate the supply from the appliance for the convenience of any subsequent removal or servicing. Connection of the appliance to the gas mains or liquid gas must be carried out according to the prescribed regulation in force, and only after it is ascertained that it is adaptable to the type of gas to be used. If not, follow the instructions indicated in the paragraph headed "Adaptation to different gas types". On some models the gas supply can be connected on the left or on the right, as necessary;



to change the connection, reverse the position of the hose holder with that of the cap and replace the gasket (supplied with the appliance). In the case of connection to liquid gas, by tank, use pressure regulators that conform to the

regulation in force. The gas supply must be connected to the left of the appliance. Be sure that the hose does not pass through the rear of the cooker touching hot parts.

! Make sure the supply pressure conforms with the values shown in the table entitled "Characteristics of the burners and nozzles". **When the cooker is installed between cabinets (recessed), the gas connection must be effected by an approved flexible hose with bayonet fitting (BS 669 Current Edition). The gas inlet for the cookers is a threaded G 1/2 gas female fitting.**

Connecting the gas supply

To make the connection, a flexible hose should be used corresponding to the current gas regulations which are:

- the hose must never be at any point in its length in contact with the "hot" parts of the cooker;
- the hose must never be longer than 1,5 metre;
- the hose must not be subject to any tension or torsional stress and it must not have any excessively narrow curves or bottlenecks;
- the hose must be easy to inspect along its entire length to check its condition;

* Only available in certain models

- the hose must always be in good condition, never attempt to repair.

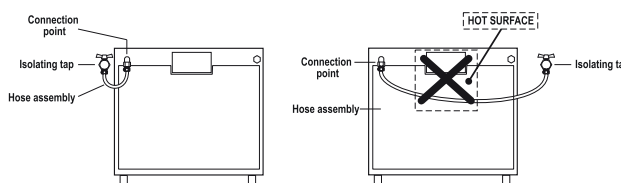

! The installation must comply with gas safety (installation and use) regulations 1984. In all cases for the above, by law, a qualified, Gas Safe approved engineer must be called for installation.

Electrical connection

Power supply voltage and frequency: 230-240V a.c. 50/60 Hz.

! The supply cable must be positioned so that it never reaches at any point a temperature 50°C higher than the room temperature. The cable must be routed away from the rear vents. Should you require it, you may use a longer cable, however, you must ensure that the cable supplied with the appliance is replaced by one of the same specifications in accordance with current standards and legislation.

Your appliance is supplied with a 13 amp fused plug that can be plugged into a 13 amp socket for immediate use. Before using the appliance please read the instructions below.

WARNING - THIS APPLIANCE MUST BE EARTHED. THE FOLLOWING OPERATIONS SHOULD BE CARRIED OUT BY A QUALIFIED ELECTRICIAN.

Replacing the fuse:

When replacing a faulty fuse, a 13 amp ASTA approved fuse to BS 1362 should always be used, and the fuse cover re-fitted. If the fuse cover is lost, the plug must not be used until a replacement is obtained.

Replacement fuse covers:

If a replacement fuse cover is fitted, it must be of the correct colour as indicated by the coloured marking or the colour that is embossed in words on the base of the plug. Replacements can be obtained directly from your nearest Service Depot.

Removing the plug:

If your appliance has a non-rewireable moulded plug and you should wish to remove it to add a cable extension or to re-route the mains cable through partitions, units etc., please ensure that either:

- the plug is replaced by a fused 13 amp re-wireable plug bearing the BSI mark of approval.
- or:

- the mains cable is wired directly into a 13 amp cable outlet, controlled by a switch, (in compliance with BS 5733) which is accessible without moving the appliance.

! For appliances with a rating greater than 13 amp (eg: electric hob, double ovens and freestanding electric cookers etc.) the mains cable must be wired into a cooker output point with a rating of 45 amp. In this case the cable is not supplied.

Disposing of the plug:

Ensure that before disposing of the plug itself, you make the pins unusable so that it cannot be accidentally inserted into a socket. Instructions for connecting cable to an alternative plug:

! The wires in the mains lead are coloured in accordance with the following code:

Green & Yellow	- Earth
Blue	- Neutral
Brown	- Live

If the colours of the wires in the mains lead do not correspond with the coloured markings identifying the terminals in your plug, proceed as follows:
 Connect Green & Yellow wire to terminal marked "E" or or coloured Green or Green & Yellow.
 Connect Brown wire to terminal marked "L" or coloured Red.
 Connect Blue wire to terminal marked "N" or coloured Black.

If a 13 amp plug (BS 1363) is used it must be fitted with a 13 amp fuse. A 15 amp plug must be protected by a 15 amp fuse, either in the plug or adaptor or at the distribution board. If you are in any doubt about the electrical supply to your machine, consult a qualified electrician before use.

How to connect an alternative plug:

The wires in this mains lead are coloured in accordance with the following code:

BLUE	"NEUTRAL" ("N")
BROWN	"LIVE" ("L")
GREEN AND YELLOW	"EARTH" ("E")

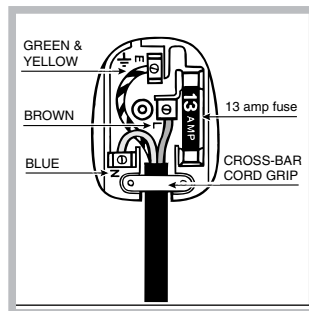

Disposing of the appliance

When disposing of the appliance please remove the plug by cutting the mains cable as close as possible to the plug body and dispose of it as described above.

Checking the connection for leaks

When the installation process is complete, check the hose fittings for leaks using a soapy solution. Never use a flame.

Adapting to different types of gas

It is possible to adapt the appliance to a type of gas other than the default type (this is indicated on the rating label on the cover).

Adapting the hob

Replacing the nozzles for the hob burners:

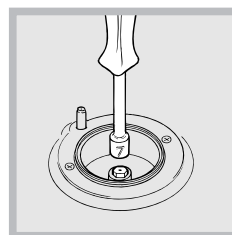

- Remove the hob grids and slide the burners off their seats.
- Unscrew the nozzles using a 7 mm socket spanner (see figure), and replace them with nozzles suited to the new type of gas (see *Burner and nozzle specifications table*).

3. Replace all the components by following the above instructions in reverse.

Adjusting the hob burners' minimum setting:

- Turn the tap to the minimum position.
- Remove the knob and adjust the regulatory screw, which is positioned inside or next to the tap pin, until the flame is small but steady.

! If the appliance is connected to a liquid gas supply, the regulatory screw must be fastened as tightly as possible.

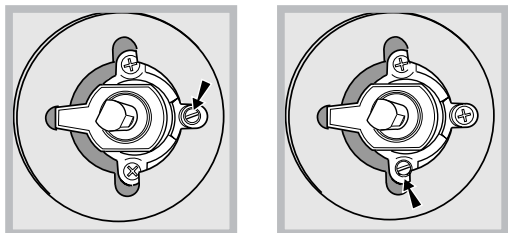

3. While the burner is alight, quickly change the position of the knob from minimum to maximum and vice versa several times, checking that the flame is not extinguished.

- ! The hob burners do not require primary air adjustment.
- ! After adjusting the appliance so it may be used with a different type of gas, replace the old rating label with a new one that corresponds to the new type of gas (these labels are available from Authorised Technical Assistance Centres).
- ! Should the gas pressure used be different (or vary slightly) from the recommended pressure, a suitable pressure regulator must be fitted to the inlet hose in accordance with current national regulations relating to “regulators for channelled gas”.

Adapting the oven

Replacing the oven burner nozzle:

1. Remove the oven compartment.

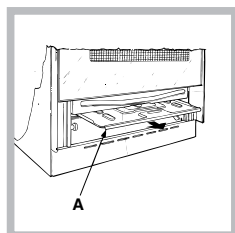

2. Slide out the protection panel A (see diagram).

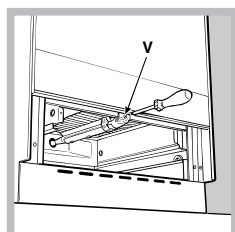

3. Remove the oven burner after unscrewing the screws V (see figure). The whole operation will be made easier if the oven door is removed.

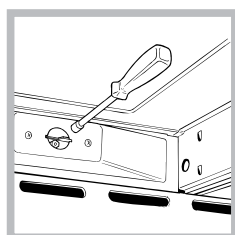

4. Unscrew the nozzle using a special nozzle socket spanner (see figure) or with a 7 mm socket spanner, and replace it with a new nozzle that is suited to the new type of gas (see *Burner and nozzle specifications table*).

Adjusting the gas oven burner's minimum setting:

1. Light the burner (see *Start-up and Use*).
2. Turn the knob to the minimum position (MIN) after it has been in the maximum position (MAX) for approximately 10 minutes.
3. Remove the knob.
4. Tighten or loosen the adjustment screws on the outside of the thermostat pin (see figure) until the flame is small but steady.
- ! If the appliance is connected to liquid gas, the adjustment screw must be fastened as tightly as possible.
5. Turn the knob from the MAX position to the MIN position quickly or open and shut the oven door, making sure that the burner is not extinguished.

Adapting the grill

Replacing the grill burner nozzle:

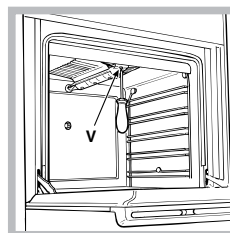

1. Remove the oven burner after loosening screw V (see figure).

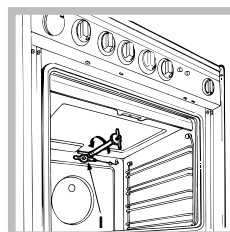

2. Unscrew the grill burner nozzle using a special nozzle socket spanner (see figure) or preferably with a 7 mm socket spanner, and replace it with a new nozzle that is suited to the new type of gas (see *Burner and nozzle specifications table*).

! Be careful of the spark plug wires and the thermocouple tubes.

! The oven and grill burners do not require primary air adjustment.

! After adjusting the appliance so it may be used with a different type of gas, replace the old rating label with a new one that corresponds to the new type of gas (these labels are available from Authorised Technical Assistance Centres).

! Should the gas pressure used be different (or vary slightly) from the recommended pressure, a suitable pressure regulator must be fitted to the inlet hose in accordance with current national regulations relating to “regulators for channelled gas”.

Table of burner and nozzle specifications

Table 1

Burner	Diameter (mm)	Thermal Power kW (p.c.s.*)		Liquid Gas				Natural Gas	
		Nominal	Reduced	By-Pass 1/100 (mm)	Nozzle 1/100 (mm)	Flow* g/h		Nozzle 1/100 (mm)	Flow* l/h
						***	**		
Fast (Large)(R)	100	3.00	0.7	41	87	218	214	128	286
Semi Fast (Medium)(S)	75	1.90	0.4	30	70	138	136	104	181
Auxiliary (Small)(A)	51	1.00	0.4	30	52	73	71	76	95
Oven	-	2.60	1.0	46	78	189	186	119	248
Grill	-	2.30	-	-	75	167	164	114	219
Supply Pressures	Nominal (mbar)					28-30	37	20	
	Minimum (mbar)					20	25	17	
	Maximum (mbar)					35	45	25	

* At 15°C and 1013 mbar- dry gas

** Propane P.C.S. = 50,37 MJ/Kg

*** Butane P.C.S. = 49,47 MJ/Kg

Natural P.C.S. = 37,78 MJ/m³

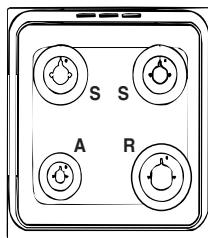

IS50G
IS50G1

TECHNICAL DATA	
Oven dimensions (HxWxD)	34x39x44 cm
Volume	58 l
Useful measurements relating to the oven compartment	width 42 cm depth 44 cm height 17 cm
Power supply voltage and frequency	see data plate
Burners	may be adapted for use with any type of gas shown on the data plate, which is located inside the flap or, after the oven compartment has been opened, on the left-hand wall inside the oven.
	EC Directives: 2006/95/EC dated 12/12/06 (Low Voltage) and subsequent amendments - 2004/108/EC dated 15/12/04 (Electromagnetic Compatibility) and subsequent amendments - 2009/142/EC dated 30/11/09 (Gas) and subsequent amendments - 93/68/EEC dated 22/07/93 and subsequent amendments - 2002/96/EC. 1275/2008 (Stand-by/ Off mode)



Description of the appliance

Overall view

GB

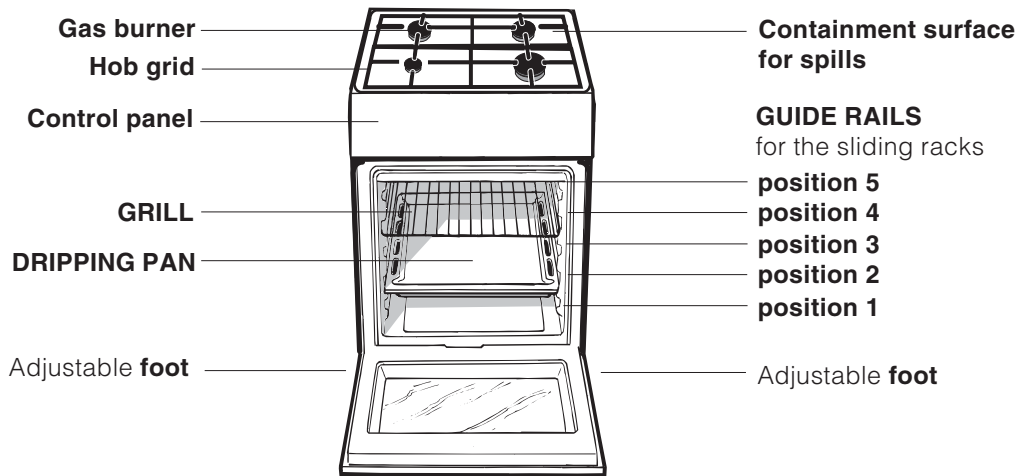

Control panel

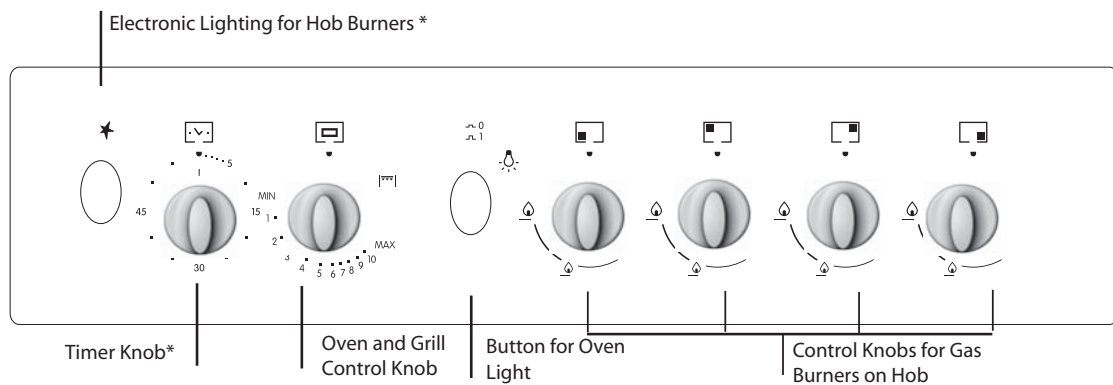

* Only available in certain models.

Start-up and use



GB

Using the hob

Lighting the burners

For each BURNER knob there is a complete ring showing the strength of the flame for the relevant burner.

To light one of the burners on the hob:

1. Press the BURNER knob and turn it in an anticlockwise direction so that it is pointing to the maximum flame setting .
2. Adjust the intensity of the flame to the desired level by turning the BURNER knob in an anticlockwise direction. This may be the minimum setting , the maximum setting  or any position in between the two.

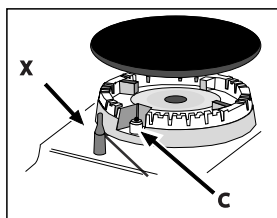

If the appliance is fitted with an electronic lighting device* (see figure), press the ignition button, marked with the symbol

 then hold the BURNER knob down and turn it in

an anticlockwise direction, towards the maximum flame setting, until the burner is lit.

Several models are equipped with an ignition device which is built into the knob; in this case the electronic ignition device* is present (see figure) but the ignition button is not. Simply press the BURNER knob and turn it in an anticlockwise direction so that it is pointing to the maximum flame setting, until the burner is lit. The burner may be extinguished when the knob is released. If this occurs, repeat the operation, holding the knob down for a longer period of time.

! If the flame is accidentally extinguished, switch off the burner and wait for at least 1 minute before attempting to relight it.

If the appliance is equipped with a flame failure safety device*, press and hold the BURNER knob for approximately 2-3 seconds to keep the flame alight and to activate the device.

To switch the burner off, turn the knob until it reaches the stop position .

* Only available in certain models.

Practical advice on using the burners

For the burners to work in the most efficient way possible and to save on the amount of gas consumed, it is recommended that only pans that have a lid and a flat base are used. They should also be suited to the size of the burner.

Burner	∅ Cookware diameter (cm)
Fast (R)	24 - 26
Semi Fast (S)	16 - 20
Auxiliary (A)	10 - 14

To identify the type of burner, please refer to the diagrams contained in the "Burner and nozzle specifications".

Using the oven

! The first time you use your appliance, heat the empty oven with its door closed at its maximum temperature for at least half an hour. Ensure that the room is well ventilated before switching the oven off and opening the oven door. The appliance may emit a slightly unpleasant odour caused by protective substances used during the manufacturing process burning away.

! Before operating the product, remove all plastic film from the sides of the appliance.

! Never put objects directly on the bottom of the oven; this will avoid the enamel coating being damaged. Only use position 1 in the oven when cooking with the rotisserie spit.

Lighting the oven

To light the oven burner:

Press the BURNER knob and turn it in an anticlockwise direction so that it is pointing to the maximum flame setting .

If, after 15 seconds, the burner is still not alight, release the knob, open the oven door and wait for at least 1 minute before trying to light it again.

! The oven is fitted with a safety device and it is therefore necessary to hold the OVEN control knob down for approximately 6 seconds.

! If the flame is accidentally extinguished, switch off the burner and wait for at least 1 minute before attempting to relight the oven.

Adjusting the temperature

To set the desired cooking temperature, turn the OVEN control knob in an anticlockwise direction. Temperatures are displayed on the control panel and may vary between MIN (140°C) and MAX (240°C). Once the set temperature has been reached, the oven will keep it constant by using its thermostat.

Conventional Oven	
Gas mark	°C
MIN	MIN
1	145
2	150
3	160
4	170
5	180
6	190
7	200
8	210
9	220
10	230
MAX	240

Oven light

The light may be switched on at any moment by pressing the OVEN LIGHT button.

Timer*

To activate the Timer proceed as follows:

1. Turn the TIMER knob in a clockwise direction for almost one complete revolution to set the buzzer.
2. Turn the TIMER knob in an anticlockwise direction to set the desired length of time.

Lower compartment*

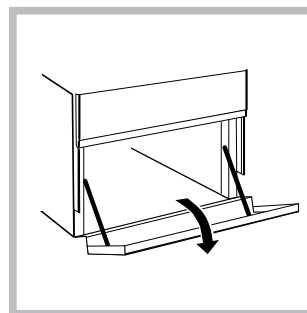

There is a compartment underneath the oven that may be used to store oven accessories or deep dishes. To open the door pull it downwards (see figure).

! The internal surfaces of the compartment (where present) may become hot.

! Do not place flammable materials in the lower oven compartment.

In gas cooker models, there is a sliding protection layer A that shields the lower compartment from the heat generated by the burner (see figure).

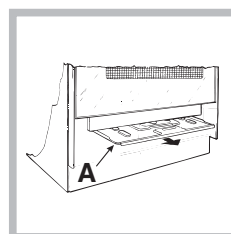

To remove the sliding protection remove the screw S (see figure). To replace it, lock it in place with the screw S.

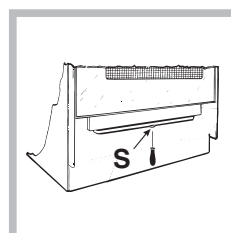

! Before using the oven make sure that the sliding protection is fixed correctly.

Grill

To light the grill, press the OVEN control knob while turning it in a clockwise direction until it reaches the position. The grill enables the surface of food to be browned evenly and is particularly suitable for roast dishes, schnitzel and sausages. Place the rack in position 4 or 5 and the dripping pan in position 1 to collect fat and prevent the formation of smoke.

! The grill is fitted with a safety device and it is therefore necessary to hold the OVEN control knob down for approximately 6 seconds.

! If the flame is accidentally extinguished, switch off the burner and wait for at least 1 minute before attempting to relight the grill.

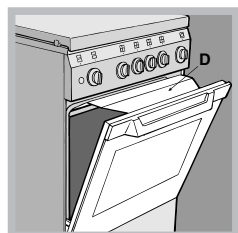

! When using the grill, leave the oven door ajar, positioning the deflector D between the door and the control panel (see figure) in order to prevent the knobs from overheating.

* Only available in certain models.

Oven cooking advice table

Food to be cooked	Wt. (Kg)	Cooking position of shelves from bottom	Temperature (°C)	Pre-heating time (min)	Cooking time (min.)
Pasta					
Lasagne	2.5	2	200-210	10	75-85
Cannelloni	2.5	2	200	10	50-60
Pasta bakes au gratin	2.5	2	200	10	50-60
Meat					
Veal	1.5	3	200-210	10	95-100
Chicken	1.5	3	210-220	10	90-100
Duck	1.8	3	200	10	100-110
Rabbit	2.0	3	200	10	70-80
Pork	2.1	3	200	10	70-80
Lamb	1.8	3	200	10	100-105
Fish					
Mackerel	1.1	3	180-200	10	45-50
Dentex	1.5	3	180-200	10	45-55
Trout baked in paper	1.0	3	180-200	10	45-50
Pizza					
Napolitan	1.0	4	210-220	15	20-25
Cake					
Biscuits	0.5	4	180	15	25-35
Tarts	1.1	4	180	15	40-45
Savoury pie	1.0	4	180	15	50-55
Raised Cakes	1.0	4	170	15	40-45
Grill cooking					
Veal steaks	1	4		5	15-20
Cutlets	1,5	4		5	20
Hamburgers	1	3		5	20-30
Mackerels	1	4		5	15-20
Toast sandwiches	n.° 4	4		5	4-5

NB: cooking times are approximate and may vary according to personal taste. When cooking using the grill, the dripping-pan must always be placed on the 1st oven rack from the bottom.

* Only available in certain models.

! This appliance has been designed and manufactured in compliance with international safety standards. The following warnings are provided for safety reasons and must be read carefully.

General safety

- **These instructions are only valid for the countries whose symbols appear in the manual and on the serial number plate.**
- The appliance was designed for domestic use inside the home and is not intended for commercial or industrial use.
- The appliance must not be installed outdoors, even in covered areas. It is extremely dangerous to leave the appliance exposed to rain and storms.
- Do not touch the appliance with bare feet or with wet or damp hands and feet.
- **The appliance must be used by adults only for the preparation of food, in accordance with the instructions outlined in this booklet. Any other use of the appliance (e.g. for heating the room) constitutes improper use and is dangerous. The manufacturer may not be held liable for any damage resulting from improper, incorrect and unreasonable use of the appliance.**
- The instruction booklet accompanies a class 1 (insulated) or class 2 - subclass 1 (recessed between 2 cupboards) appliance.
- Keep children away from the oven.
- Make sure that the power supply cables of other electrical appliances do not come into contact with the hot parts of the oven.
- The openings used for the ventilation and dispersion of heat must never be covered.
- Always use oven gloves when placing cookware in the oven or when removing it.
- Do not use flammable liquids (alcohol, petrol, etc...) near the appliance while it is in use.
- Do not place flammable material in the lower storage compartment or in the oven itself. If the appliance is switched on accidentally, it could catch fire.
- Always make sure the knobs are in the • position and that the gas tap is closed when the appliance is not in use.
- When unplugging the appliance, always pull the plug from the mains socket; do not pull on the cable.

- Never perform any cleaning or maintenance work without having disconnected the appliance from the electricity mains.
- If the appliance breaks down, under no circumstances should you attempt to repair the appliance yourself. Repairs carried out by inexperienced persons may cause injury or further malfunctioning of the appliance. Contact Assistance.
- Do not rest heavy objects on the open oven door.
- The appliance should not be operated by people (including children) with reduced physical, sensory or mental capacities, by inexperienced individuals or by anyone who is not familiar with the product. These individuals should, at the very least, be supervised by someone who assumes responsibility for their safety or receive preliminary instructions relating to the operation of the appliance.
- Do not let children play with the appliance.

Disposal

- When disposing of packaging material: observe local legislation so that the packaging may be reused.
- The European Directive 2002/96/EC relating to Waste Electrical and Electronic Equipment (WEEE) states that household appliances should not be disposed of using the normal solid urban waste cycle. Exhausted appliances should be collected separately in order to optimise the cost of re-using and recycling the materials inside the machine, while preventing potential damage to the atmosphere and to public health. The crossed-out dustbin is marked on all products to remind the owner of their obligations regarding separated waste collection. Exhausted appliances may be collected by the public waste collection service, taken to suitable collection areas in the area or, if permitted by current national legislation, they may be returned to the dealers as part of an exchange deal for a new equivalent product. All major manufacturers of household appliances participate in the creation and organisation of systems for the collection and disposal of old and disused appliances.

Respecting and conserving the environment

- You can help to reduce the peak load of the electricity supply network companies by using the oven in the hours between late afternoon and the early hours of the morning. • Check the door seals regularly and wipe them clean to ensure they are free of debris so that they adhere properly to the door, thus avoiding heat dispersion.

Care and maintenance

GB

Switching the appliance off

Disconnect your appliance from the electricity supply before carrying out any work on it.

Cleaning the appliance

! Do not use abrasive or corrosive detergents such as stain removers, anti-rust products, powder detergents or sponges with abrasive surfaces: these may scratch the surface beyond repair.

! Never use steam cleaners or pressure cleaners on the appliance.

- It is usually sufficient simply to wash the hob using a damp sponge and dry it with absorbent kitchen roll.
- The stainless steel or enamel-coated external parts and the rubber seals may be cleaned using a sponge that has been soaked in lukewarm water and neutral soap. Use specialised products for the removal of stubborn stains. After cleaning, rinse well and dry thoroughly. Do not use abrasive powders or corrosive substances.
- The hob grids, burner caps, flame spreader rings and the hob burners can be removed to make cleaning easier; wash them in hot water and non-abrasive detergent, making sure all burnt-on residue is removed before drying them thoroughly.
- For hobs with electronic ignition, the terminal part of the electronic lighting devices should be cleaned frequently and the gas outlet holes should be checked for blockages.
- The inside of the oven should ideally be cleaned after each use, while it is still lukewarm. Use hot water and detergent, then rinse well and dry with a soft cloth. Do not use abrasive products.
- Clean the glass part of the oven door using a sponge and a non-abrasive cleaning product, then dry thoroughly with a soft cloth. Do not use rough abrasive material or sharp metal scrapers as these could scratch the surface and cause the glass to crack.
- The accessories can be washed like everyday crockery, and are even dishwasher safe.
- Stainless steel can be marked by hard water that has been left on the surface for a long time, or by aggressive detergents containing phosphorus. After cleaning, rinse well and dry thoroughly. Any remaining drops of water should also be dried.

Inspecting the oven seals

Check the door seals around the oven periodically. If the seals are damaged, please contact your nearest Authorised After-sales Service Centre. We recommend that the oven is not used until the seals have been replaced.

Gas tap maintenance

Over time, the taps may become jammed or difficult to turn. If this occurs, the tap must be replaced.

! This procedure must be performed by a qualified technician who has been authorised by the manufacturer.

Replacing the oven light bulb

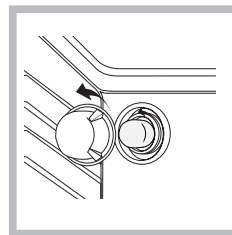

1. After disconnecting the oven from the electricity mains, remove the glass lid covering the lamp socket (*see figure*).
2. Remove the light bulb and replace it with a similar one: voltage 230 V, wattage 25 W, cap E 14.

3. Replace the lid and reconnect the oven to the electricity supply.

Assistance

Please have the following information handy:

- The appliance model (Mod.).
- The serial number (S/N).

This information can be found on the data plate located on the appliance and/or on the packaging.

Guarantee

12 months Parts and Labour Guarantee

Your appliance has the benefit of our manufacturer's guarantee, which covers the cost of breakdown repairs for twelve months from the date of purchase.

This gives you the reassurance that if, within that time, your appliance is proven to be defective because of either workmanship or materials, we will, at our discretion, either repair or replace the appliance at no cost to you.

This guarantee is subject to the following conditions:

- The appliance has been installed and operated correctly and in accordance with our operating and maintenance instructions.
- The appliance is used only on the electricity or gas supply printed on the rating plate.
- The appliance has been used for normal domestic purposes only.
- The appliance has not been altered, serviced, maintained, dismantled, or otherwise interfered with by any person not authorised by us.
- Any repair work must be undertaken by us or our appointed agent.
- Any parts removed during repair work or any appliance that is replaced become our property.
- The appliance is used in the United Kingdom or Republic of Ireland.

The guarantee does not cover:

- Damage resulting from transportation, improper use, neglect or interference or as a result of improper installation.
- Replacement of any consumable item or accessory. These included but not limited to: plugs, cables, batteries, light bulbs, fluorescent tubes and starters, covers and filters.
- Replacement of any removable parts made of glass or plastic.

THIS GUARANTEE WILL NOT APPLY IF THE APPLIANCE HAS BEEN USED IN COMMERCIAL OR NON-DOMESTIC PREMISES.

5 Year Parts Guarantee

Indesit also offers you a free 5 year parts guarantee. This additional guarantee is conditional on you registering your appliance with us and the parts being fitted by one of our authorised engineers. There will be a charge for our engineer's time. To activate the extra parts warranty on your appliance, simply call our registration line on **08448 24 24 24 (Republic of Ireland 01 230 0800)**

Extended Guarantees

We offer a selection of protection plans that enable you to fully cover yourself against the expense of repair bills for the life of your policy. To find the ideal plan for you please call our advice line on **08448 226 226 (Republic of Ireland 01 230 0233)**.

Free Helpdesk Service

We have a dedicated team who can provide free advice and assistance with your appliance if you experience any technical difficulties within the first 90 days of ownership. Simply call our Indesit Service Hotline on **08448 224 224 (Republic of Ireland 0818 313 413)** for telephone assistance, or, where necessary, to arrange for an engineer to call.



After Sales Service

No one is better placed to care for your Indesit appliance during the course of its working life than us – the manufacturer.

GB

Essential Contact Information

Indesit Service

We are the largest service team in the UK and Ireland offering you access to 400 skilled telephone advisors and 1000 fully qualified engineers on call to ensure you receive fast, reliable, local service.

UK: 08448 224 224
Republic of Ireland: 0818 313 413
www.indesitservice.co.uk

Please note: Our advisors will require the following information:

Model number:

Serial number:

Parts and Accessories

We supply a full range of genuine replacement parts as well as accessory products that protect and hygienically clean your appliance to keep it looking good and functioning efficiently throughout its life.

UK: 08448 225 225
Republic of Ireland: 0818 313 413
www.indesitservice.co.uk

Appliance Registration

We want to give you additional benefits of Indesit ownership. To activate your free 5 year parts guarantee you must register your appliance with us.

UK: 08448 24 24 24
Republic of Ireland: 01 230 0800
www.indesitservice.co.uk

Indesit Company UK Ltd. Morley Way, Peterborough, PE2 9JB
Indesit Company Unit 49 Airways Industrial Estate, Dublin 17

Recycling and Disposal Information

As part of Indesit's continued commitment to helping the environment, Indesit reserves the right to use quality, recycled components to keep down customer costs and minimise material wastage.

Please dispose of packaging and old appliances carefully. To minimise the risk of injury to children, remove the door, plug, and cut the mains cable off flush with the appliance. Dispose of these parts separately to ensure that the appliance can no longer be plugged into mains socket, and the door cannot be locked shut.

Free Manuals Download Website

<http://myh66.com>

<http://usermanuals.us>

<http://www.somanuals.com>

<http://www.4manuals.cc>

<http://www.manual-lib.com>

<http://www.404manual.com>

<http://www.luxmanual.com>

<http://aubethermostatmanual.com>

Golf course search by state

<http://golfingnear.com>

Email search by domain

<http://emailbydomain.com>

Auto manuals search

<http://auto.somanuals.com>

TV manuals search

<http://tv.somanuals.com>