

indesit

KG 6407 GV/G

KG 6407 AV/G

KG 6407 LV/G

KG 6408 WV/G

KG 6408 XV/G

GB **Cooker with ventilated oven**
Instructions for installation and use

Important

To maintain the **EFFICIENCY** and **SAFETY** of this appliance, we recommend:

- use only the **MANUFACTURER Service**
- use only **ORIGINAL Spare Parts**

- 1** These instructions are only for those countries whose symbols appear in the booklet and on the matriculation plate of the appliance.
- 2** This appliance is intended for non-professional use within the home.
- 3** This owner's manual is for a class 1 appliance (installed independently) or class 2 - sub-class 1 appliances (installed between two cabinets).
- 4** Before using your appliance, read your owner's manual carefully since it provides important instructions for the safe installation, use and maintenance of your cooker. Keep in a safe place for future reference.
- 5** When you have removed the packing, check that the appliance is not damaged. If you have any doubts, do not use the appliance, contact your nearest Ariston Service Centre. Never leave the packing components (plastic bags, foamed polystyrene, nails, etc.) within the reach of children since they are a source of potential danger.
- 6** The appliance must be installed only by a qualified person in compliance with the instructions provided. The manufacturer declines all responsibility for improper installation which may harm persons and animals and damage property.
- 7** The electrical safety of this appliance can only be guaranteed if the cooker is correctly and efficiently earthed, in compliance with current regulations on electrical safety. Always ensure that the earthing is efficient; if you have any doubts call in a qualified electrician to check the system. The manufacturer declines all responsibility for damage resulting from a system which has not been earthed.
- 8** Before connecting the appliance to the mains, check that the specifications indicated on the rating plate (on the appliance and/or packaging) correspond to those of the electrical mains system of your home.
- 9** The cooker must be connected to the mains electrical supply via a earthed 13 or 15 amp. socket outlet, meeting the electrical current requirements detailed under "Electrical Connection" in the installation section later in this book.
- 10** The openings and slots used for ventilation and dispersion of heat on the rear and below the control panel must never be covered.
- 11** This appliance must be used for the purpose for which it was expressly designed. Any other use (e.g. heating rooms) is considered to be improper and consequently dangerous. The manufacturer declines all responsibility for damage resulting from improper and irresponsible use.
- 12** A number of fundamental rules must be followed when using electrical appliances. The following are of particular importance:
 - do not touch appliance with wet or damp hands or feet
 - do not use the appliance while bare-footed
 - do not use extension leads other than with the utmost caution
- do not pull the power supply cable or the appliance itself to disconnect the plug from the socket.
- do not expose the appliance to weather agents (raining, sun, etc)
- do not allow unsupervised children or inexperienced persons to use the appliance.
- 13** Always switch off the electrical supply to the cooker and allow it to cool down before carrying out any cleaning operations etc.
- 14** Remember if you are discarding any domestic appliance with which children etc. may play, make it safe by removing the Mains Cable from it, after first disconnecting the electricity supply. Remove glass parts where possible, and consider sharp edges etc. which may now be exposed.
- 15** Oven gloves or similar protection should be used when moving containers in or out of hot ovens and care should be taken to avoid contact with hot surfaces of exposed skin on wrists or arms.
- 16** One of the commonest types of accident involving cooking appliances is burns to babies and young children. These can occur by:
 - Touching hot parts
 - Being splashed with hot liquids
 - By pulling projecting pan handles and tipping hot liquids over themselves
- 17** Please remember that a small child's skin is far more sensitive and therefore more easily burnt than an adult. You are, therefore, strongly advised to keep babies and young children well clear of this appliance during use and whilst it is cooling down after use.
- 18** Unstable or out of shape pans should not be used on the hob in case they cause spillage of hot liquids.
- 19** Pans must only be placed in the centre of electric rings and of grids on gas burners. Placing pans off centre or to one side may cause spillage.
- 20** Special care should be taken when using chip pans etc. in order to avoid splashing or spillage of hot oil. They should not be used unattended since overheated oil may boil over and ignite on the hot heating element or gas flame.
- 21** Some parts of the appliance, in particular the hot plates, remain heated for a long time after use. Make sure not to touch them.
- 22** Never use flammable liquids such as alcohol or gasoline, etc. near the appliance when it is in use.
- 23** Make sure the knobs are in the "●"/"○" position when the appliance is not in use.
- 24** **Gas appliances require regular air exchange to ensure trouble-free performance. When installing the cooker, follow the instructions provided in the paragraph on "Positioning" the appliance.**
- 25** When you are using the grill or the oven, some parts of the door can become very hot. Keep children away from these.

Installation instructions

All instruction on the following pages must be carried out by a competent person (corgi registered) in compliance with gas safety (installation and use) regulation 1984.

Important: disconnect the cooker from the electricity and gas supply when any adjustment, etc.

Positioning

Important: this unit may be installed and used only in permanently ventilated rooms according to the British Standards Codes Of Practice: B.S. 6172/B.S. 5440, Par. 2 and B.S. 6891 Current Editions. The following requirements must be observed:

- The cooker should not be installed in a bed sitting room with a volume of less than 20m^3 . If it is installed in a room of volume less than 5m^3 an air vent of effective area of 110cm^2 is required, if it is installed in a room of volume between 5m^3 and 10m^3 a supplementary airvent area of 50cm^2 is required, while if the volume exceeds 11m^3 no airvent is required. However, if the room has a door or a window which opens directly to the outside no air vent is required even when the volume is between 5m^3 and 11m^3 .
- During prolonged use of the appliance you may consider it necessary to open a window to the outside to improve ventilation.
- If there are other fuel burning appliances in the same room, B.S.5440 Part 2 Current Edition, should, be consulted to determine the requisite air vent requirements.

Installation of the cooker

The cooker is prepared with protection degree against excessive heating of type X, the appliance can therefore be installed next to cabinets, provided the height does not exceed that of the hob. If the cooker is placed touching walls or sides of neighbouring cabinets, these must be capable of withstanding a temperature rise of 60°C above room temperature. Levelling feet supplied with the cooker, can be fitted to the cooker to accomodate uneven floors. See fitting instruction on feet packing. For a correct installation of the cooker the following precautions must be followed:

- The cooker may be located in a kitchen, a kitchen/diner or bed sitting room, but not in a bathroom or shower room.
- The furniture units next to the cooker, that is higher than the working boards, must be placed at least 110 mm from the edge of the board. Curtains must not be fitted immediately behind the cooker or within 110 mm. of the sides of the cooker.
- The hoods must be installed according to the requirements in the hood handbook.
- Wall cabinets may be fitted in line with the sides of the base units, providing that the lower edge of the wall cabinet is a minimum of 420 mm. above the worktop. The minimum distance combustible material kitchen units can be fitted directly above the worktop is 700 mm. (see Fig. A)
- The wall in contact with the back of the cooker must be of flameproof material.
- The cooker is fitted with the a safety chain that must be attached to a hook, secured to the wall behind the appliance (see Fig. B).

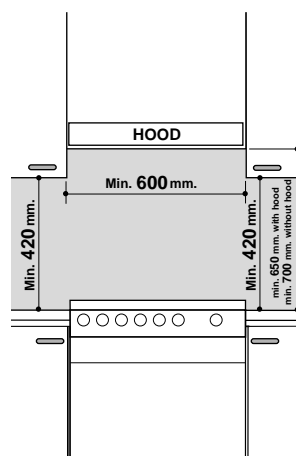

Fig. A



Fig. B

Connecting the gas

The cooker should be connected to the gas-supply by a corgi registered installer. During installation of this product it is essential to fit an approved gas tap to isolate the supply from the appliance for the convenience of any subsequent removal or servicing. Connection of the appliance to the gas mains or liquid gas must be carried out according to the prescribed regulation in force, and only after it is ascertained that it is adaptable to the type of gas to be used. If not, follow the instructions indicated in the paragraph headed "Adaptation to different gas types". In the case of connection to liquid gas, by tank, use pressure regulators that conform to the regulation in force. The gas supply must be connected to the right of the appliance. Be sure that the hose does not pass through the rear of the cooker touching hot parts.

Important: make sure the supply pressure conforms with the values shown in the table entitled "Characteristics of the burners and nozzles".

When the cooker is installed between cabinets (recessed), the gas connection must be effected by an approved flexible hose with bayonet fitting (BS 669 Current Edition). The gas inlet for the cookers is a threaded G 1/2 gas female fitting.

Connecting the gas supply

To make the connection, a flexible hose should be used corresponding to the current gas regulations which are:

- the hose must never be at any point in its length in contact with the "hot" parts of the cooker;
- the hose must never be longer than 1.5 metre;
- the hose must not be subject to any tension or torsional stress and it must not have any excessively narrow curves or bottlenecks;
- the hose must be easy to inspect along its entire length to check its condition;
- the hose must always be in good condition, never attempt to repair.

Important: the installation must comply with gas safety (installation and use) regulations 1984. In all cases for the above, by law, a qualified, corgi approved engineer must be called for installation.

Electrical Connection

Your appliance is now supplied with a 13 amp fused plug that can be plugged into a 13 amp socket for immediate use. Before using the appliance please read the instructions below. **WARNING - THIS APPLIANCE MUST BE EARTHED. THE FOLLOWING OPERATIONS SHOULD BE CARRIED OUT BY A QUALIFIED ELECTRICIAN.**

Replacing the fuse:

When replacing a faulty fuse, a 13 amp ASTA approved fuse to BS 1362 should always be used, and the fuse cover re-fitted. If the fuse cover is lost, the plug must not be used until a replacement is obtained.

Replacement fuse covers:

If a replacement fuse cover is fitted, it must be of the correct colour as indicated by the coloured marking or the colour that is embossed in words on the base of the plug. Replacements can be obtained directly from your nearest Service Depot.

Removing the plug:

If your appliance has a non-rewireable moulded plug and you should wish to remove it to add a cable extension or to re-route the mains cable through partitions, units etc., please ensure that either:

- the plug is replaced by a fused 13 amp re-wireable plug bearing the BSI mark of approval

or:

- the mains cable is wired directly into a 13 amp cable outlet, controlled by a switch, (in compliance with BS 5733) which is accessible without moving the appliance.

Please note: for appliances with a rating greater than 13 amp (eg: electric hob, double ovens and freestanding electric cookers etc.) the mains cable must be wired into a cooker output point with a rating of 45 amp. In this case the cable is not supplied.

Disposing of the plug:

Ensure that before disposing of the plug itself, you make the pins unusable so that it cannot be accidentally inserted into a socket.

Instructions for connecting cable to an alternative plug:

Important: the wires in the mains lead are coloured in accordance with the following code:

- Green & Yellow - **Earth**
- Blue - **Neutral**
- Brown - **Live**

As the colours of the wires in the mains lead may not correspond with the coloured markings identifying the terminals in your plug, proceed as follows:

Connect Green & Yellow wire to terminal marked "E" or \perp or coloured Green or Green & Yellow.

Connect Brown wire to terminal marked "L" or coloured Red. Connect Blue wire to terminal marked "N" or coloured Black. If a 13 amp plug (BS 1363) is used it must be fitted with a 13 amp fuse. A 15 amp plug must be protected by a 15 amp fuse, either in the plug or adaptor or at the distribution board. If you are in any doubt about the electrical supply to your machine, consult a qualified electrician before use.

How to connect an alternative plug:

The wires in this mains lead are coloured in accordance with the following code:

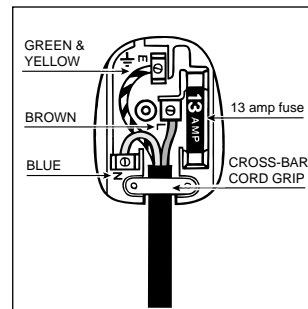

- BLUE "NEUTRAL" ("N")
- BROWN "LIVE" ("L")
- GREEN AND YELLOW "EARTH" ("E")

Disposing of the appliance:

When disposing of the appliance please remove the plug by cutting the mains cable as close as possible to the plug body and dispose of it as described above.

Adaptation to the different types of gas

The cooker is supplied adjusted for natural gas (methane).

To adapt the cooker to a type of gas which is different from the one it was designed for the following operations must be carried out:

Important: disconnect the cooker from the electricity.

1) Replacement of nozzles and regulating air.

a) Upper burners

- Remove grids, flame separator plates and burners from the hob.
- Loosen screws "A" (see Fig. A) remove bushes from work top and lift the latter up.
- Loosen screws "B" and lift the pipe "C" (Fig. B).
- Unscrew the nozzles and replace them (see Fig. B) with those suitable for the new gas as supplied with the cooker in accordance with table 2.

- To regulate the amount of air to the burner, adjust hose "C" according to the values indicated in table 1, "Air Regulation for Burners". Once the adjustment is made, fix hose "C" with the screw "B" (Fig. B).

2) Regulation of minimums

When installing the cooker make sure that the minimums of all upper burners are duly regulated. Regulation of minimums is **essential** when changing the type of gas. Proceed as follows:

- Taking one burner at a time, switch on to the maximum position, remove the knob, insert the special screwdriver into the hole of the tap "T" rod and slightly unscrew to regulate the minimum. If the tap rod hasn't the hole insert a screwdriver into the hole of the fascia panel and slightly unscrew "S" screw to regulate the minimum (Fig. A).
- Then turn the tap to minimum position.

- Rotate to the left to increase the flame and rotate to the right to lower the flame.

N.B.: in the case of liquefied gas, the regulation screw must be screwed in the bottom.

Check that the flame does not turn off when you turn the tap quickly from high to low

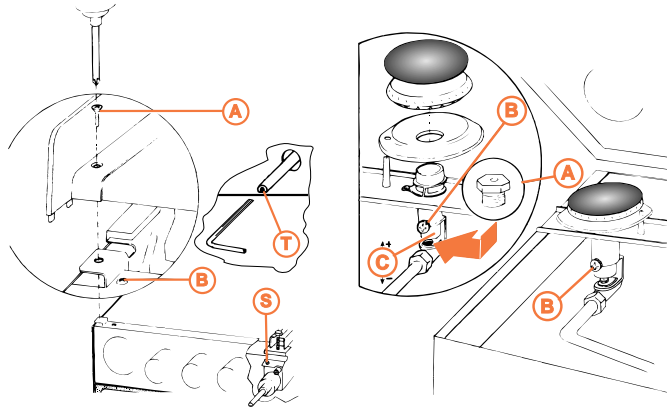

Fig. A

Fig. B

Attention:

On completion of the above operation, please replace the current technical data label with a new one containing details of the gas which the appliance has now been converted to. The new technical data label is contained in the nozzles Kit supplied with the cooker.

Note

Should the pressure of the gas used be different (or vary) from the recommended pressure, it is necessary to fit a suitable pressure regulator onto the inlet pipe in compliance with current National Regulations relative to "regulators for channelled gas".

Table 1

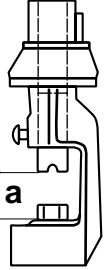
Burner	Regulating air "a" (mm)		
	Butane Propane	Natural Gas G 20	
Fast large (Front right)	11	0	
Fast (Rear left)	13	0	
Medium (Rear right)	13	0	
Medium (Front left)	13	0	

Burner and nozzles characteristics

Table 2

Burner	Diameter (mm)	Thermal power kW (p.c.s.*)		Liquid Gas				Natural Gas	
				By-pass 1/100 (mm)	Nozzle 1/100 (mm)	Flow* g/h		Nozzle 1/100 (mm)	Flow* l/h
						***	**		
Front-Right	90	3.30	0.70	42	90	240	236	135	314
Rear-Left	78	2.70	0.70	42	83	196	193	122	257
Front-Left	50	1.70	0.40	29	65	124	121	97	162
Rear-Right	50	1.70	0.40	29	65	124	121	97	162
Supply pressures	Nominal (mbar)		37**		28-30***		20		
	Minimum (mbar)		25**		20***		17		
	Maximum (mbar)		45**		35***		25		

* At 15°C and 1013 mbar-dry gas

** Propane P.C.S. = 50,37 MJ/Kg

*** Butane P.C.S. = 49,47 MJ/Kg

Natural P.C.S. = 37,78 MJ/m³

Technical characteristics

Mains frequency and voltage of the electric section and characteristics of the gas section

Model	Gas section		Electric section	
	Class	Rated power kW (1)	Voltage	Power (W)
KG 6407 GV/G KG 6407 AV/G KG 6407 LV/G KG 6408 WV/G KG 6408 XV/G	I12H3+	9.4 (683 g/h - G30) (671 g/h - G31)	230-240V~ 50 Hz	1900-2000

(1) The values in g/h refer to the capacities with liquid gas (Butane, Propane).

Dimensions of the oven:

- width cm 44
- depth cm 42
- height cm 30.5

Volume of the oven:

56 Liters

Dimensions of food-warmer drawer:

- width cm 51
- depth cm 48
- height cm 8



This appliance conforms with the following European Economic Community directives:

- 73/23/EEC of 19/02/73 (Low Voltage) and subsequent;
- 89/336/EEC of 03/05/89 (Electromagnetic Compatibility) and subsequent;
- 90/396/EEC of 29/06/90 (Gas) and subsequent.
- 93/68/EEC of 22/07/93 and subsequent.

The cooker with fan oven

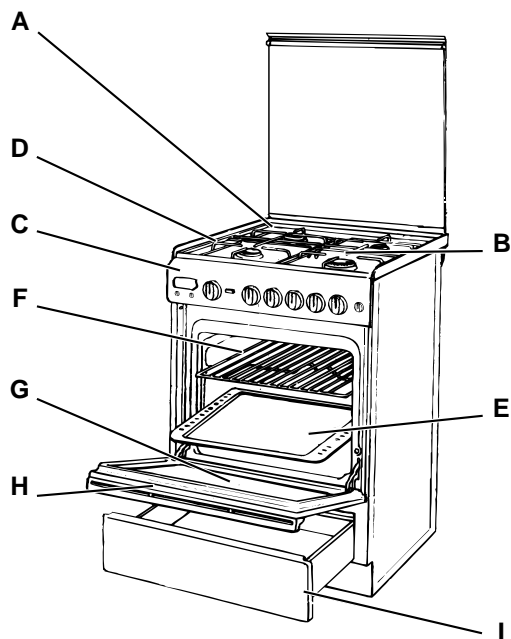

- A Hob surface
- B Gas burners
- C Control panel
- D Top grate
- E Drip tray or cooking plate
- F Oven shelf
- G Inner glass
- H Oven door
- I Drawer
- J Instant electronic lighting device

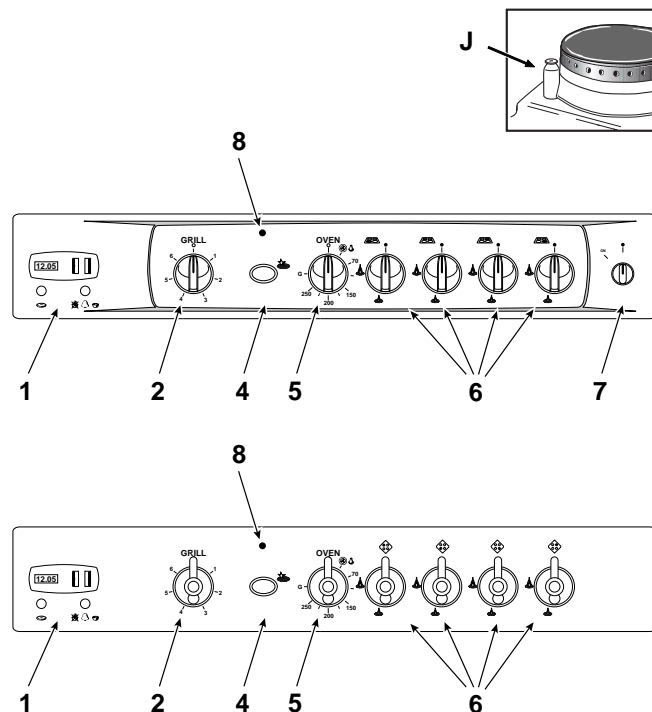

- 1 PROGRAMMER
- 2 GRILL CONTROL
- 4 ELEC. IGNITION SWITCH
- 5 OVEN CONTROL
- 6 BURNER CONTROLS
- 7 CUT-OFF CONTROL (only on certain models)
- 8 OVEN/GRILL WARNING-LIGHT

The different functions of the cooker

The various functions included in the cooker are selected by operating the control devices located on the cooker control panel. The cooker is equipped, with a mechanical automatic programmer. Before operating the oven or the grill, ensure that the symbol  coincides with the pointer on dial 4.

Attention: before using the oven and grill for the first time, turn the oven on for approximately one half hour. Make sure that the oven is empty, the thermostat on high, the door open, and the room properly ventilated. The odor which can be detected at times is due to the evaporation off the substances used to protect the oven and the grill during the period between the and installation of the appliance.

Attention: Only use the bottom shelf of the oven when using the rotisserie to cook (where present). For all other types of cooking, never use the bottom shelf and never place anything on the bottom of the oven when it is in operation because this could damage the enamel. Always place your cookware (dishes, aluminium foil, etc. etc.) on the grate provided with the appliance inserted especially along the oven guides.

The oven knob (5)

This knob is used to select the different functions of the oven and choose the right cooking temperature for the food to be prepared in the oven among the temperatures shown on the knob (from 70°C to 250°C). By turning the knob clockwise the oven lamp lights up and the forced ventilation inside the oven comes on; when knob is set at

symbol  foods are quickly defrosted with no alteration of their protein content; when the knob is turned further, the heating elements comes on and you may choose, among the full range of values shown, the most ideal temperature for the food you are cooking. To do so, match the desired temperature value shown on the panel.

70	150	200	250
----	-----	-----	-----

This temperature is reached automatically and kept constant by the knob-controlled thermostat. The fan oven, which reduces preheating time by an average of 40%, **permits energy saving of 30% in the preheating phase. Maximum economy is obtained, however, when cooking at the same time on several shelves** (up to 3) greater amounts of food of the same type or even different types of food **whit no mixing of flavours and smell.**

Grill position G

Turning the oven knob till to this position, the oven light turns on, so does the infra-red ray grill. The rather high and direct temperature of the grill permits browning the outside of meats immediately thus keeping in the juices and assuring tenderness.

Use of the grill

The table shows the temperatures, cooking times and positions recommended for obtaining the best cooking results. The variable temperature control (2) will provide varying grill temperature when rotated from "6" to "1" and

may be adjusted to vary the level of heat at any time during the grilling operation. Position 1 corresponds to minimum power, position 6 corresponds to maximum power. On 0 position the grill does not operate.

To operate the grill follow the procedure outlined below

- Turn the oven control knob (5) clockwise until the grilling symbol is **G**. The element is now on.
- The variable grill control can now be operated to select the required heat.

Note: whilst operating the grill ensure the oven door is ajar in the vertical position and the heat deflector is correctly positioned (Fig. A).

The guard plate gets hot when the grill is in use. Remove it with care, using an oven glove or similar, and put it away carefully in safe place. The guard plate must be removed before attempting to fully close the oven door.

Caution: to operate the grill Pan use the proper handles as shown in figure B.

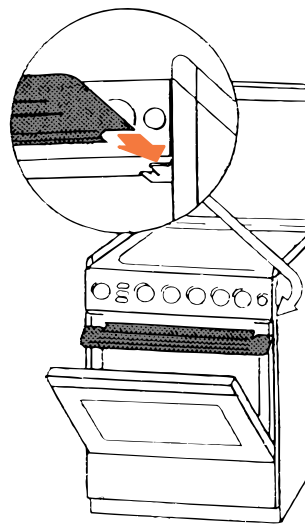

Fig. A

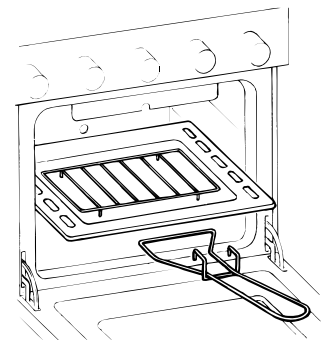

Fig. B

Cut-off gas control (only on certain models)

The hotplate lid is fitted with a safety device which cuts off the gas supply to all burners when the lid is closed. To restore the gas supply proceed as follows:

- Lift up the lid to the vertical position.
- Make sure that all burner knobs are in the OFF position.
- Rotate the cut-off knob anticlockwise to the ON position: the cut-off valve will open and the knob will remain in the ON position.

Warning: the gas supply will shut off automatically when the lid is closed and the cut-off knob will return to the OFF position automatically. Don't turn the cut-off knob to the OFF position manually, you may damage the safety device.

Hob

Check that CUT-OFF Gas Control (only on certain models) is in the ON position.



Warning: You are reminded that although this appliance has a gas shut off device for when the lid is lowered, residual heat of the burners could damage the lid. Therefore do not lower the lid until the cooking surface has cooled down.

The control knobs for the cook-top gas burners (6)

The position of the gas burner controlled by each one of the knobs is shown by a solid ring. To light one of the

burners, hold a lighted match or lighter near the burner. Push and turn the corresponding knob counter clockwise

till to **max** position . Each burner can be operated at its maximum, minimum or intermediate power. Show on the knob are the different symbols for off • and it is in this position when the symbol corresponds with the reference

mark for **maximum**  and **minimum** . To obtain these settings, turn the knob counter clockwise with respect to the off position. To turn off the burner, turn the knob clockwise until it stops (corresponding again with the symbol •).

Gas cook-top electronic ignition (4)

This device operates when a slight pressure is applied on

the button "4" marked with . To light a specific burner just press the button labeled "4" while pushing the corresponding knob all the way in and turning it counter-clockwise until it lights. For immediate lighting, first press the button and then turn the knob.

Important: should the burner flames accidentally go out, turn off the control knob and wait at least 1 minute before trying to re-light.

Oven light button (3)

This is marked by the symbol  and switches on the light inside the oven so that you can control the cooking without opening the door.

Pilot lamp

This turns on whenever any electric heating element in the oven is on.

Practical advice for using the burners

In order to obtain the best performance keep in mind the following:

- use the appropriate cookware for each burner (see table) so that the flames do not emerge from beneath the bottom of the container.
- Only flat bottom containers should be used.

- At the boiling point, turn the knob to minimum.
- Always use cookware with a lid.

Burner	Cookware Diameter (cm)
Fast Large (RG)	24 - 26
Fast (R)	22 - 24
Semi-Fast (Front right)	16 - 20
Semi-Rapid (Front left)	16 - 20

N.B. On the models supplied with a reducer shelf, remember that this should be used only for the semi-rapid burner when you use casserole dishes with a diameter under 12 cm.

Important: The cooker is equipped with a protective grate located on the front part of the cooking surface to prevent cookware from falling accidentally. When the front burners are in use, this grate must be raised.

Inner glass oven door

The cooker is provided with an inner glass that can be removed unscrewing the two screws. **This glass must be replaced after cleaning and always be in position when cooking.**

Oven door

You can buy a special kit to reduce door temperature when the oven is on and save energy. If there are little children in the house, this kit is a must. The kit code number is 039888 or 039104 (for traditional models with plate-metal door) and it may be purchased for installation from an authorised dealer or a Technical Assistance Service centre indicated in the list included with the appliance documents.

The cooking programmer

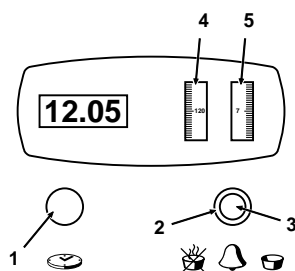

The Cooking Programmer

The figure illustrates the controls for the programmer. Knobs 1, 2 and 3 allow you to make all the necessary settings.



Knob 1

When turned in the clockwise direction, it allows you to

correct the time setting on the digital clock (upon installation, after a power failure or when it runs fast or slow etc.).

Knob 2

When turned in the clockwise direction, it:

- sets the duration of the cooking time (max of 210 minutes);
- stops the acoustical signal ( setting);
- sets the oven on manual mode ( setting).

The symbols for the above appear in quadrant 4.

Knob 3

When pressed and turned in either the clockwise or counterclockwise direction, it sets the start of the cooking time displayed in quadrant 5. When the clock is adjusted, you must check that the time on the clock is synchronized

with the time shown in quadrant 5.

Manual Operating Mode for the Oven

The oven can be used normally, i.e. without being programmed. In this case, knob 2 must be turned in the clockwise direction until the  symbol appears in quadrant 4.

Semiautomatic Operating Mode

The start time is normal and end cooking time is programmed:

prepare the food to be cooked; rotate knob 2 in the clockwise direction and set the number of minutes for the end cooking time in quadrant 4; turn the oven knob to the desired temperature. Make sure that the time on the clock is synchronized with the time shown in quadrant 5.

Automatic Operating Mode

Arrange the food to be cooked; turn knob 2 in the clockwise direction, setting the length of the cooking time in quadrant 4; press and rotate knob 3 in the clockwise direction to set the cooking start time in quadrant 5; turn the oven knob to the desired temperature setting.

At the end of the cooking time, the "0" in quadrant 4 will be aligned with the marker; this indicates that the oven is no longer operating. An acoustical signal will sound to indicate that the cooking time is over.

To stop the signal, turn knob 2 in the clockwise direction so that the  symbol is aligned with the marker in quadrant 4.

Example of programmer setting for the automatic operating mode for the oven.

End cooking time: 7:00 p.m.

Length of cooking time: 2 hours.

Arrange the food that is to be cooked; turn knob 2 in the clockwise direction, setting the length of the cooking time (2 hours) in quadrant 4.; press and rotate knob 3 in the

clockwise direction, setting the end cooking time, 5:00, in quadrant 5; turn the oven control knob to the temperature setting desired.

After these settings have been made, the programmer will automatically stop and start the oven at 5:00 and 7:00 respectively.

Timer

The programmer can also serve as a timer only if the oven is not programmed for automatic operating mode **and is not on.**

To use the timer feature, turn knob 2 in the clockwise direction to set the time in quadrant 4. The maximum time setting is 210 minutes. To stop the acoustical signal, turn knob 2 in the clockwise direction until the  symbol is aligned with the marker in quadrant 4.

Programmed Cooking

Programmed cooking is no different than normal cooking. The programmer does not control the cooking time setting when you are not present or doing other work. Therefore, it is best to use the completely automatic mode for foods which do not require special attention. When programming a time greater than 12 hours, it must always refer to the first 12 hours of the day (e.g. 20:00 must be understood to mean 8:00 and so forth). Therefore, it is possible to program cooking 12 hours in advance.

Important

To use the oven manually (without the programmer), the following is necessary:

1. Upon adjusting the clock, make sure that the **time shown is synchronized with the time shown in quadrant 5.**
2. Turn knob 2 in the clockwise direction so that the  symbol is aligned with the marker in quadrant 4.

Practical suggestion for oven cooking

Defrosting of Foods in the oven

Defrosting occurs in the same way as at room temperature; however at a faster rate. Electric power consumption for the defrosting of foods is very low (ab. 0.38 KWh/hr)

Cooking

Different types of foods placed on the various cooking shelves of the oven can be cooked simultaneously without any mixing up of smells. A considerable saving of electric power is also achieved at the same time. When several oven shelves are used for simultaneous cooking of various foods, always leave some space from one pan to the other for better air circulation. Make sure that the air circulation slots on the bottom wall of the oven are not obstructed. It is advisable to always use aluminium pans, ensuring that the foods contained there in does not overflow, as this could cause burning due to the flow of hot air. The intermediate oven shelves should be used when single cooking is done.

Caution

H. M. Government Ministry of Agriculture Fisheries and Food announcement necessitates the following warning. The insertion of foodstuffs covered in close wrap plastic (cling film) into utensils for cooking or within the oven for baking/

roasting is not recommended as it is possible that certain elements of the plastic film can be absorbed by foodstuffs when subjected to heat.

Baking cakes

Remember to preheat the oven when baking cakes. The temperatures are normally about 160°C. Avoid opening the door during baking. Cake dough must be of a fairly firm consistency to avoid long baking times. In general:

Pastry is too dry

Increase the temperature by 10°C and reduce the cooking time.

Pastry dropped

Use less liquid or lower the the temperature by 10°C.

Pastry is too dark on top

Place it on a lower rack, lower the temperature, and increase the cooking time.

Cooked well on the inside but sticky on the outside

Use less liquid, lower the temperature, and increase the cooking time.

The pastry sticks to the pan

Grease the pan well and sprinkle it with a dusting of flour.

I used more than one level and they are not all at the same cooking point

Use a lower temperature setting. It is not necessary to remove the food from all the racks at the same time.

Cooking fish and meat

Meat must weigh at least one Kg. (2.2 lbs) to stop it becoming too dry. When cooking white meat, fowl and fish use low temperatures. (150°C-175°C). When red meat must be superficially well-cooked but succulent inside, it is advisable to start with a high temperature (200-220°C) for a short time, and then to reduce it at a later point. Generally speaking, the more meat there is, the lower the temperature and the longer the cooking time should be. Place the meat in the centre of the grid and put a spill-tray underneath to catch grease drips. Insert the grid so that it is in the middle of the oven. If more heat from below is required, use the 1° bottom shelf. For tastier roasts, wrap the meat with bacon rashers or dot the meat with lard and place it in the upper part of the oven. When some types of food are cooked in the ventilated oven (duck, rabbit, large fowl) they become too dry; in these cases, better results are obtained using the combined oven.

Cooking table

The following chart provides Gas Oven Marks approximate conversions from degrees Fahrenheit to degrees Celsius (formel known as Centigrade). This chart can be used for conversions of recipes which give oven temperatures of "F" or Gas mark. However do ensure a reduction is made to temperature and cooking times with Forced Air cooking: - 20°C in every 100°C, ten minutes in every hour.

OVEN TEMPERATURE GUIDE				
Gas. Mark	Description	Temperature		Forced Air Oven Approximate Settings °C
		°C	°F	
1/4 1/2	COOL	110	230	90
		121	250	100
1/2 1	VERY SLOW	121	250	100
		235	275	110
1 2	SLOW	135	275	110
		149	300	120
2 3	VERY MODERATE	149	300	120
		177	350	145
4	MODERATE	190	375	150
5	MODERATE HOT	204	400	160
6 7	HOT	218	425	175
		233	450	190
8 9	VERY HOT	246	475	205
		260	500	210

Cooker routine maintenance and cleaning

Before each operation, disconnect the cooker from the electricity. To assure the long life of the cooker, it must be thoroughly cleaned frequently, keeping in mind that:

- the enamelled parts and the self-cleaning panels are washed with warm water without using any abrasive powders or corrosive substances which could ruin them;
- the inside of the oven should be cleaned fairly often while it is still warm using warm water and detergent, followed by careful rinsing and drying;
- the flame spreaders should be washed frequently with hot water and detergent taking care to eliminate any scale;
- in cookers equipped with automatic lighting, the terminal part of the electronic instant lighting devices should be cleaned frequently and the gas outlet holes of the flame spreaders should be checked to make sure they are free of any obstructions;
- the electric plates are cleaned with a damp cloth and they should be lubricated with a little oil while they still

warm;

- stainless steel may become marked if it comes into contact with very hard water or harsh detergents (containing phosphorous) for long periods of time. After cleaning, it is advisable to rinse thoroughly and dry. It is also recommended to dry any water drops;
- in models with glass covers, the covers are cleaned with hot water and use of rough cloths or abrasives is to be avoided.

Important: periodically check the wear of the gas hose and substitute it if there are any defects; we recommended changing it every year.

Greasing the taps

The taps may jam in time or they may become difficult to turn. If so, they must be cleaned internally and the grease replaced.

N.B: This operation must be carried by a technician authorised by the manufacturer.

Replacing the oven lamp

- Unplug the oven from the mains;
- Remove the glass cover of the lamp-holder;

- Remove the lamp and replace with a lamp resistant to high temperatures (300°C) with the following characteristics:
 - Voltage 230V
 - Wattage 25W
 - Type E14
- Replace the glass over and connect the oven to the mains.

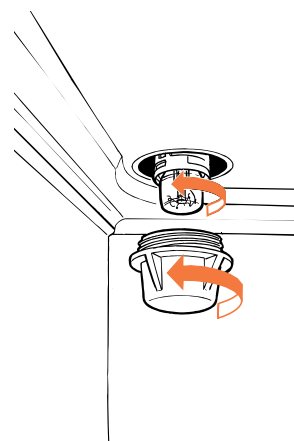

Practical advice for oven cooking

Food to be cooked	Wt. (wt)	Cooking position of shelves from bottom	Temperature (°C)	Pre-heat time (min.)	Cooking time (min.)
Paste					
Lasagne	2,5	3	210	-	75-80
Cannelloni	2,5	3	210	-	75-80
Oven-baked noodles	2,5	3	210	-	75-80
Meat					
Veal	1,7	3	230	-	85-90
Chicken	1,5	3	220	-	110-115
Turkey	3,0	3	Max	-	95-100
Duck	1,8	3	230	-	120-125
Rabbit	2,0	3	230	-	105-110
Pork	2,1	3	230	-	100-110
Lamb	1,8	3	230	-	90-95
Fish					
Mackerel	1,1	3	210-230	-	55-60
Dentex	1,5	3	210-230	-	60-65
Trout baked in paper	1,0	3	210-230	-	40-45
Pizze					
Napolitan	1,0	3	Max	15	30-35
Cake					
Biscuits	0,5	3	180	15	30-35
Tarts	1,1	3	180	15	30-35
Chocolate cake	1,0	3	200	15	45-50
Yeast cakes	1,0	3	200	15	50-55
Grill cooking					
Toast	n.4	4			10
Pork chops	1,5	4			30
Mackerel	1,1	4			35

Note: cooking times are approximate and may vary according to personal taste.



Merloni Elettrodomestici spa
viale Aristide Merloni, 47 - 60044 Fabriano
tel. 0732/6611 - telex 560196 - fax 0732/662954
www.Merloni.com

Cucina con forno ventilato
06/00 - 195013906.08 Xerox Business Services - Docutech

Free Manuals Download Website

<http://myh66.com>

<http://usermanuals.us>

<http://www.somanuals.com>

<http://www.4manuals.cc>

<http://www.manual-lib.com>

<http://www.404manual.com>

<http://www.luxmanual.com>

<http://aubethermostatmanual.com>

Golf course search by state

<http://golfingnear.com>

Email search by domain

<http://emailbydomain.com>

Auto manuals search

<http://auto.somanuals.com>

TV manuals search

<http://tv.somanuals.com>