

GB

English,2

KP900GX

Contents

Installation, 2-5

- Room ventilation
- Disposing of combustion fumes
- Positioning and levelling
- Electrical connection
- Gas connection
- Table of burner and nozzle specifications
- Table of characteristics

Description of the appliance, 6

- Overall view
- Control panel

Start-up and use, 7-11

- Using the hob
- Setting the time
- Using the oven
- Cooking modes for Multi-function (1st Oven)
- Cooking modes for conventional-function (2nd Oven)
- Practical cooking advice
- Oven cooking advice table

Precautions and tips, 12

- General safety
- Disposal
- Respecting and conserving the environment

Care and maintenance, 13

- Switching the appliance off
- Cleaning the appliance
- Replacing the oven light bulb
- Gas tap maintenance
- Assistance

Installation

GB

! Before operating your new appliance please read this instruction booklet carefully. It contains important information concerning the safe installation and operation of the appliance.

! Please keep these operating instructions for future reference. Make sure that the instructions are kept with the appliance if it is sold, given away or moved.

! The appliance must be installed by a qualified professional according to the instructions provided.

! Any necessary adjustment or maintenance must be performed after the cooker has been disconnected from the electricity supply.

Room ventilation

The appliance may only be installed in permanently-ventilated rooms, in accordance with current national legislation. The room in which the appliance is installed must be ventilated adequately so as to provide as much air as is needed by the normal gas combustion process (the flow of air must not be lower than 2 m³/h per kW of installed power).

The air inlets, protected by grilles, should have a duct with an inner cross section of at least 100 cm² and should be positioned so that they are not liable to even partial obstruction (see figure A).

These inlets should be enlarged by 100% - with a minimum of 200 cm² - whenever the surface of the hob is not equipped with a flame failure safety device. When the flow of air is provided in an indirect manner from adjacent rooms (see figure B), provided that these are not communal parts of a building, areas with increased fire hazards or bedrooms, the inlets should be fitted with a ventilation duct leading outside as described above.

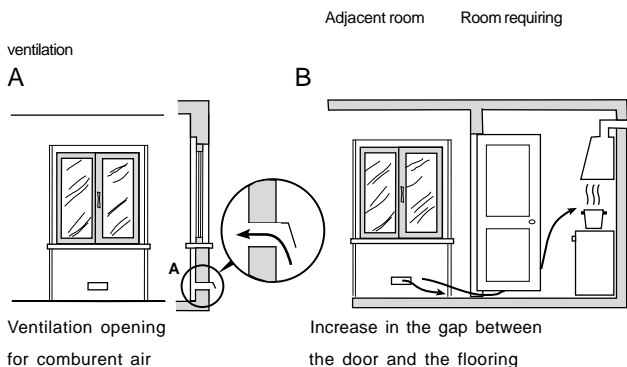

! After prolonged use of the appliance, it is advisable to open a window or increase the speed of any fans used.

Disposing of combustion fumes

The disposal of combustion fumes should be guaranteed using a hood connected to a safe and efficient natural suction chimney, or using an electric fan that begins to operate automatically every time the appliance is switched on (see figure).

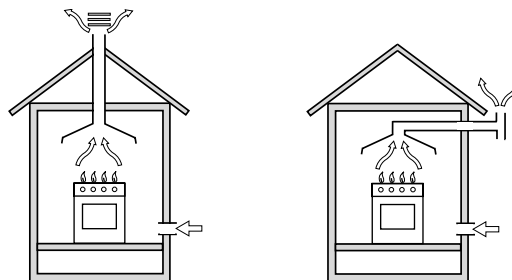

Fumes channeled outside

Fumes channeled through straight a chimney or a branched flue system (reserved for cooking appliances)

! The liquefied petroleum gases are heavier than air and collect by the floor, therefore all rooms containing LPG cylinders must have openings leading outside so that any leaked gas can escape easily.

LPG cylinders, therefore, whether partially or completely full, must not be installed or stored in rooms or storage areas that are below ground level (cellars, etc.). Only the cylinder being used should be stored in the room; this should also be kept well away from sources of heat (ovens, chimneys, stoves) that may cause the temperature of the cylinder to rise above 50°C.

Positioning and levelling

! It is possible to install the appliance alongside cupboards whose height does not exceed that of the hob surface.

! Make sure that the wall in contact with the back of the appliance is made from a non-flammable, heat-resistant material (T 90°C).

To install the appliance correctly:

- Place it in the kitchen, the dining room or the bed-sit (not in the bathroom).
- If the top of the hob is higher than the cupboards, the appliance must be installed at least 600 mm away from them.
- If the cooker is installed underneath a wall cabinet, there must be a minimum distance of 420 mm between this cabinet and the top of the hob. This distance should be increased to 700 mm if the wall cabinets are flammable (see figure).

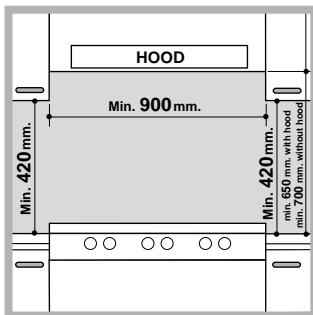

- Do not position blinds behind the cooker or less than 200 mm away from its sides.
- Any hoods must be installed according to the instructions listed in the relevant operating manual.

Levelling

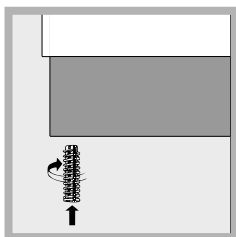

If it is necessary to level the appliance, screw the adjustable feet into the places provided on each corner of the base of the cooker (see figure).

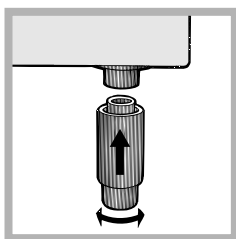

The legs* fit into the slots on the underside of the base of the cooker.

Electrical connection

WARNING – THIS APPLIANCE MUST BE EARTHED.

Electrical connection

Electric cookers come without a power supply cable. The cooker is designed to operate on an electricity supply which conforms to the electrical data shown on the Rating Plate. The cooker can be connected to the mains only after removing the back panel of the cooker itself with a screwdriver.

N.B.: the following installation procedure must be carried out by a qualified electrician. The electrical installation must comply with the IEE Regulations, Building & local By-Lays.

For the installation of the feeding cable carry out the following operations:

- Using a screwdriver, prise on the side tabs of the terminal board cover (see fig. A);
- Pull and open the junction blok lid

Important: the wires in the mains lead are coloured in accordance with the following code:

Green & Yellow	-Earth
Blue	-Neutral
Brown	-Live

As the colours of the wires in the mains lead may not correspond with the coloured markings identifying the terminals in your plug, proceed as follows:

Green & Yellow wire to terminal marked "E" or or coloured Green or Green & Yellow.

Brown wire to terminal marked "L" or coloured Red.

Blue wire to terminal marked "N" or coloured Black (see fig. B).

- fix the feeding cable in the special cable stop and close the cover.

N.B.: the power supply cable must have these minimum requirements:

Type: H05RR-F

Section: 3x2.5 mm²

Ensure that the mains cable is routed away from any brackets affixed to the rear panel and is not trapped to the rear wall when pushing the cooker into position between cabinets.

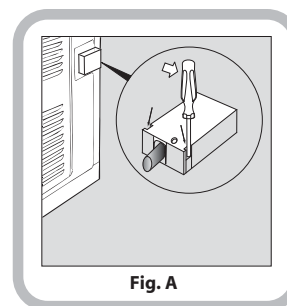

Fig. A

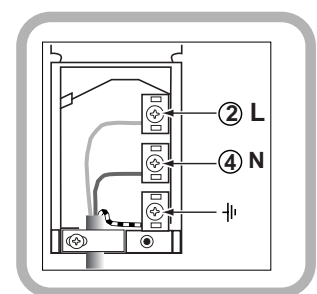

Fig. B

Gas connection

Connection to the gas network or to the gas cylinder may be carried out using a flexible rubber or steel hose, in accordance with current national legislation and after making sure that the appliance is suited to the type of gas with which it will be supplied (see the rating sticker on the cover: if this is not the case see below). When using liquid gas from a cylinder, install a pressure regulator which complies with current national regulations. To make connection easier, the gas supply may be turned sideways*: reverse the position of the hose holder with that of the cap and replace the gasket that is supplied with the appliance.

! Check that the pressure of the gas supply is consistent with the values indicated in the Table of burner and nozzle specifications (see below). This will ensure the safe operation and durability of your appliance while maintaining efficient energy consumption.

Gas connection using a flexible rubber hose

Make sure that the hose complies with current national legislation. The internal diameter of the hose must measure: 8 mm for liquid gas supply; 13 mm for methane gas supply.

Once the connection has been performed, make sure

that the hose:

- Does not come into contact with any parts that reach temperatures of over 50°C.
- Is not subject to any pulling or twisting forces and that it is not kinked or bent.
- Does not come into contact with blades, sharp corners or moving parts and that it is not compressed.
- Is easy to inspect along its whole length so that its condition may be checked.
- Is shorter than 1500 mm.
- Fits firmly into place at both ends, where it will be fixed using clamps that comply with current regulations.

! If one or more of these conditions is not fulfilled or if the cooker must be installed according to the conditions listed for class 2 - subclass 1 appliances (installed between two cupboards), the flexible steel hose must be used instead (see below).

Connecting a flexible jointless stainless steel pipe to a threaded attachment

Make sure that the hose and gaskets comply with current national legislation.

To begin using the hose, remove the hose holder on the appliance (the gas supply inlet on the appliance is a cylindrical threaded 1/2 gas male attachment).

! Perform the connection in such a way that the hose length does not exceed a maximum of 2 metres, making sure that the hose is not compressed and does not come into contact with moving parts.

Checking the tightness of the connection

When the installation process is complete, check the hose fittings for leaks using a soapy solution. Never use a flame.

Adapting to different types of gas

It is possible to adapt the appliance to a type of gas other than the default type (this is indicated on the rating label on the cover).

Adapting the hob

Replacing the nozzles for the hob burners:

1. Remove the hob grids and slide the burners off their seats.
2. Unscrew the nozzles using a 7 mm socket spanner (see *figure*), and replace them with nozzles

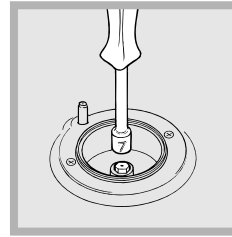

suited to the new type of gas (see *Burner and nozzle specifications table*).

3. Replace all the components by following the above instructions in reverse. Adjusting the hob burners' minimum setting:

1. Turn the tap to the minimum position.
2. Remove the knob and adjust the regulatory screw, which is positioned inside or next to the tap pin, until the flame is small but steady.

! If the appliance is connected to a liquid gas supply, the regulatory screw must be fastened as tightly as possible:

3. While the burner is alight, quickly change the position of the knob from minimum to maximum and vice versa several times, checking that the flame is not extinguished.

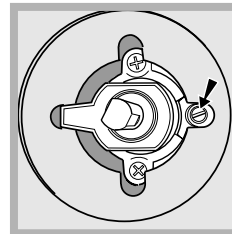

! The hob burners do not require primary air adjustment.

! After adjusting the appliance so it may be used with a different type of gas, replace the old rating label with a new one that corresponds to the new type of gas (these labels are available from Authorised Technical Assistance Centres).

! Should the gas pressure used be different (or vary slightly) from the recommended pressure, a suitable pressure regulator must be fitted to the inlet hose in accordance with current national regulations relating to "regulators for channelled gas".

Table of burner and nozzle specifications

Table 1





Burner	Diameter (mm)	Thermal Power kW (p.c.s.*)		Liquid Gas				Natural Gas			
		Nominal	Reduced	By-Pass 1/100 (mm)	Nozzle 1/100 (mm)	Flow* g/h		Nozzle 1/100 (mm)	Flow* l/h	Nozzle 1/100 (mm)	Flow* l/h
						***	**				
Fast (Large)(R)	100	3,00	0,7	41	86	218	214	116	286	143	286
Semi Fast (Medium)(S)	75	1,90	0,4	30	70	138	136	106	181	118	181
Auxiliary (Small)(A)	55	1,00	0,4	30	50	73	71	79	95	80	95
Triple Ring (TC)	130	3.25	1.5	63	91	236	232	133	309	150	309
Supply Pressures	Nominal (mbar) Minimum (mbar) Maximum (mbar)					28-30 20 35	37 25 45	20 17 25	13 6,5 18		



* At 15°C and 1013 mbar - dry gas

** Propane P.C.S. = 50.37 MJ/kg

*** Butane P.C.S. = 49.47 MJ/kg

Natural P.C.S. = 37.78 MJ/m³

TECHNICAL DATA (1 st Oven)	
Oven dimensions	H:34;W:39;D:41 cm
Volume	54 l
Burners	may be adapted for use with any type of gas shown on the data plate
Voltage and frequency	see data plate
ENERGY LABEL	Directive 2002/40/EC on the label of electric ovens. Regulation EN 50304 Energy consumption for Natural convection – heating mode:  Traditional mode; Declared energy consumption for Forced convection Class – heating mode:  Baking.
 	EC Directives: 73/23/EEC dated 19/02/73 (Low Voltage) and subsequent amendments - 89/336/EEC dated 03/05/89 (Electromagnetic Compatibility) and subsequent amendments - 90/369/EEC dated 29/06/90 (Gas) and subsequent amendments - 93/68/EEC dated 22/07/93 and subsequent amendments - 2002/96/EC.

TECHNICAL DATA (2 nd Oven)	
Dimensions	H:33.8;W:24.5;D:43.8 cm
Volume	36 l
Burners	may be adapted for use with any type of gas shown on the data plate
Voltage and frequency	see data plate
ENERGY LABEL	Directive 2002/40/EC on the label of electric ovens. Regulation EN 50304 Energy consumption for Natural convection – heating mode:  Traditional mode;
 	EC Directives: 73/23/EEC dated 19/02/73 (Low Voltage) and subsequent amendments - 89/336/EEC dated 03/05/89 (Electromagnetic Compatibility) and subsequent amendments - 90/369/EEC dated 29/06/90 (Gas) and subsequent amendments - 93/68/EEC dated 22/07/93 and subsequent amendments - 2002/96/EC.

Description of the appliance

GB

Overall view

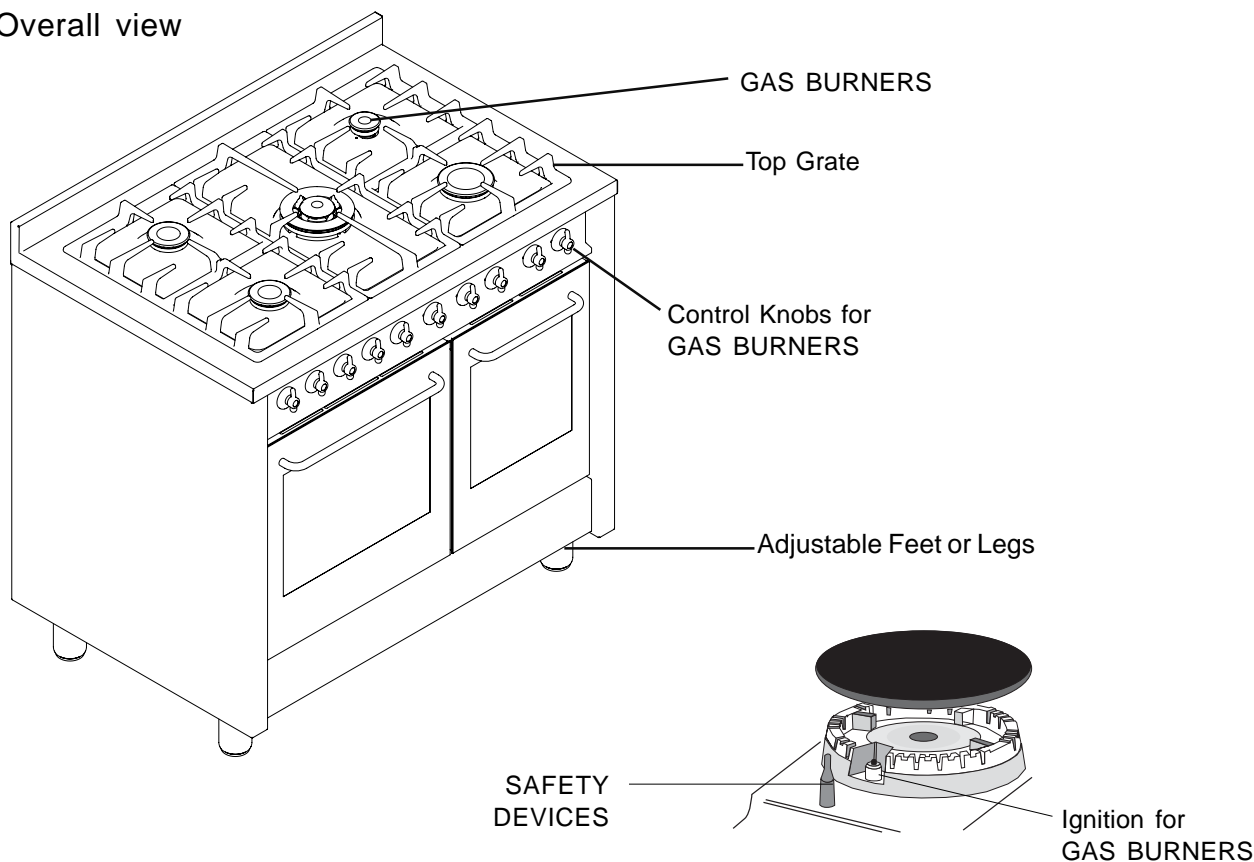

Control panel

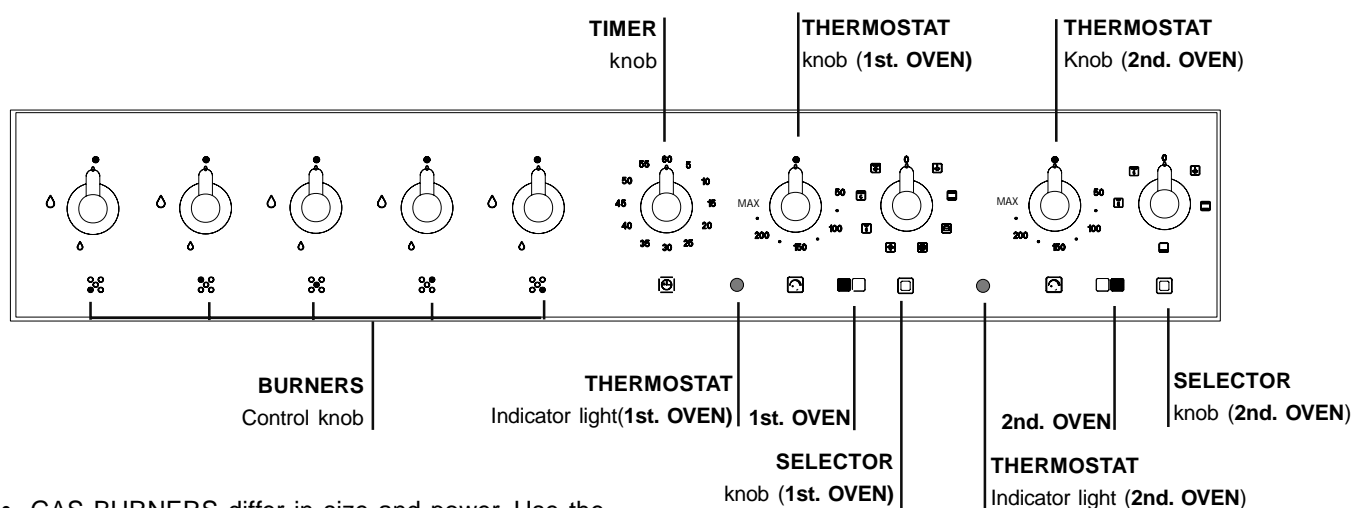



- GAS BURNERS differ in size and power. Use the diameter of the cookware to choose the most appropriate burner to cook with.
- Control Knobs for GAS BURNERS adjust the power or the size of the flame.
- GAS BURNERS ignition enables a specific burner to be lit automatically.

Using the hob

Lighting the burners

For each BURNER knob there is a complete ring showing the strength of the flame for the relevant burner. To light one of the burners on the hob:

1. Bring a flame or gas lighter close to the burner.
2. Press the BURNER knob and turn it in an anticlockwise direction so that it is pointing to the maximum flame setting .
3. Adjust the intensity of the flame to the desired level by turning the BURNER knob in an anticlockwise direction. This may be the minimum setting , the maximum setting  or any position in between the two.

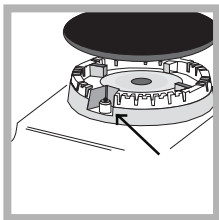

If the appliance is fitted with an electronic lighting device (see figure), press the BURNER knob and turn it in an anticlockwise direction, towards the minimum flame setting, until the burner is lit. The burner may

be extinguished when the knob is released. If this occurs, repeat the operation, holding the knob down for a longer period of time.

! If the flame is accidentally extinguished, switch off the burner and wait for at least 1 minute before attempting to relight it.

If the appliance is equipped with a flame failure safety device, press and hold the BURNER knob for approximately 2-3 seconds to keep the flame alight and to activate the device.

To switch the burner off, turn the knob until it reaches the stop position 0.

Practical advice on using the burners



For the burners to work in the most efficient way possible and to save on the amount of gas consumed, it is recommended that only pans that have a lid and a flat base are used. They should also be suited to the size of the burner:

!To identify the type of burner, please refer to the diagrams contained in the "Burner and nozzle specifications".

! For models equipped with a reducer grid, the latter must be used only for the auxiliary burner, when pans with a diameter of less than 12 cm are used.

Burner	∅ Cookware Diameter (cm)
Fast (R)	24 - 26
Semi Fast (S)	16 - 20
Auxiliary (A)	10 - 14
Triple Crown (TC)	24 - 26

Setting the time

In order to use the timer, it must be wound by turning the "S" knob almost one complete turn in the clockwise direction . Then, turning it back , set the desired time by lining up the number for the minutes with the mark on the control panel.

Using the oven

! The first time you use your appliance, heat the empty oven with its door closed at its maximum temperature for at least half an hour. Ensure that the room is well ventilated before switching the oven off and opening the oven door. The appliance may emit a slightly unpleasant odour caused by protective substances used during the manufacturing process burning away. ! Never put objects directly on the bottom of the oven; this will avoid the enamel coating being damaged.

1. Select the desired cooking mode by turning the SELECTOR knob.
2. Select the recommended temperature for the cooking mode or the desired temperature by turning the THERMOSTAT knob.

A list detailing cooking modes and suggested cooking temperatures can be found in the relevant table (see Oven cooking advice table).

During cooking it is always possible to:

- Change the cooking mode by turning the SELECTOR knob.
- Change the temperature by turning the THERMOSTAT knob.
- Stop cooking by turning the SELECTOR knob to the "0" position.

! Always place cookware on the rack(s) provided.

THERMOSTAT indicator light

When this is illuminated, the oven is generating heat. It switches off when the inside of the oven reaches the selected temperature. At this point the light illuminates and switches off alternately, indicating that the thermostat is working and is maintaining the temperature at a constant level.

OPERATION indicator light

When this is illuminated, the oven is generating heat.

Oven light

This is switched on by turning the SELECTOR knob to any position other than "0". It remains lit as long as the oven is operating. By selecting  with the knob, the light is switched on without any of the heating elements being activated.

Cooking modes for Multi-function main oven (1st Oven)

! The first time you use your appliance, heat the empty oven with its door closed at its maximum temperature for at least half an hour. Ensure that the room is well ventilated before switching the oven off and opening the oven door. The appliance may emit a slightly unpleasant odour caused by protective substances used during the manufacturing process burning away.

! A temperature value can be set for all cooking modes

between 50°C and Max, except for the following modes

- MAXI-GRILL / MINI-GRILL (recommended: set only to MAX power level)
- GRATIN (recommended: do not exceed 200°C).

TRADITIONAL OVEN mode

Both the top and bottom heating elements will come on. When using this traditional cooking mode, it is best to use one cooking rack only. If more than one rack is used, the heat will be distributed in an uneven manner.

BAKING mode

The rear heating element and the fan are switched on, thus guaranteeing the distribution of heat in a delicate and uniform manner throughout the entire oven. This mode is ideal for baking and cooking temperature sensitive foods (such as cakes that need to rise) and for the preparation of pastries on 3 shelves simultaneously.

PIZZA mode

The circular heating elements and the elements at the bottom of the oven are switched on and the fan is activated. This combination heats the oven rapidly by producing a considerable amount of heat, particularly from the element at the bottom. If you use more than one rack at a time, switch the position of the dishes halfway through the cooking process.

MULTI-COOKING mode

All the heating elements (top, bottom and circular) switch on and the fan begins to operate. Since the heat remains constant throughout the oven, the air cooks and browns food in a uniform manner. A maximum of two racks may be used at the same time.

MINI-GRILL mode

The central part of the top heating element is switched on. The high and direct temperature of the grill is recommended for food that requires a high surface temperature (veal and beef steaks, fillet steak and entrecôte). This cooking mode uses a limited amount of energy and is ideal for grilling small dishes. Place the food in the centre of the rack, as it will not be cooked properly if it is placed in the corners.

MAXI-GRILL mode

All the top heating element are activated .

GRATIN mode

The top heating element and the rotisserie (where present) are activated and the fan begins to operate. This combination of features increases the effectiveness of the unidirectional thermal radiation provided by the heating elements through forced circulation of the air throughout the oven. This helps prevent food from burning on the surface and allows the heat to penetrate right into the food.

! The GRILL and GRATIN cooking modes must be performed with the oven door shut.

Practical cooking advice

! Do not place racks in position 1 or 5 during fan-assisted cooking. Excessive direct heat can burn temperature sensitive foods.

MULTILEVEL

- Use positions 2 and 4, placing the food that requires more heat on the rack in position 2.
- Place the dripping pan on the bottom and the rack on top.

GRILL

- When using the GRILL cooking mode, place the rack in position 5 and the dripping pan in position 1 to collect cooking residues (fat and/or grease). When using the GRATIN cooking mode, place the rack in position 2 or 3 and the dripping pan in position 1 to collect cooking residues.
- We recommend that the power level is set to maximum. The top heating element is regulated by a thermostat and may not always operate constantly.

PIZZA MODE

- Use a light aluminium pizza pan. Place it on the rack provided.
For a crispy crust, do not use the dripping pan as it prevents the crust from forming by extending the total cooking time.
- If the pizza has a lot of toppings, we recommend adding the mozzarella cheese on top of the pizza halfway through the cooking process.

Cooking modes for Conventional main oven (2nd oven)

! The first time you use your appliance, heat the empty oven with its door closed at its maximum temperature for at least half an hour. Ensure that the room is well ventilated before switching the oven off and opening the oven door. The appliance may emit a slightly unpleasant odour caused by protective substances used during the manufacturing process burning away.

! A temperature value can be set for all cooking modes

between 50°C and Max, except for the following modes

- MAXI-GRILL / MINI-GRILL (recommended: set only to MAX power level)

Starting the oven

1. Select the desired cooking mode by turning the SELECTOR knob.
2. Select the recommended temperature for the cooking mode or the desired temperature by turning the THERMOSTAT knob.

A list detailing cooking modes and suggested cooking temperatures can be found in the relevant table (see Oven cooking advice table).

During cooking it is always possible to:

- Change the cooking mode by turning the SELECTOR knob.
- Change the temperature by turning the THERMOSTAT knob.
- Set the total cooking time and the cooking end time (see below).
- Stop cooking by turning the SELECTOR knob to the "0" position.

! Never put objects directly on the bottom of the oven; this will avoid the enamel coating being damaged. Only use position 1 in the oven when cooking with the rotisserie spit.

! Always place cookware on the rack(s) provided.

THERMOSTAT indicator light

When this is illuminated, the oven is generating heat. It switches off when the inside of the oven reaches the selected temperature. At this point the light illuminates and switches off alternately, indicating that the thermostat is working and is maintaining the temperature at a constant level.

Oven light

This is switched on by turning the SELECTOR knob to any position other than "0". It remains lit as long as the oven is operating. By selecting  with the knob, the light is switched on without any of the heating elements being activated.

TRADITIONAL OVEN mode

Both the top and bottom heating elements will come on. When using this traditional cooking mode, it is best to use one cooking rack only. If more than one rack is used, the heat will be distributed in an uneven manner.

PASTRY Mode

The bottom heating element comes on.

This mode is ideal for baking and cooking delicate foods - especially cakes that need to rise because the heat coming from the bottom helps the leavening process.

Please note that it takes a considerable amount of time for the higher temperatures to be reached, therefore we recommend you use the "Convection Mode" in these cases.

MINI GRILL

The top heating element comes on.

This mode can be used to brown food at the end of cooking.

MAXI GRILL

The top central heating element comes on.

The extremely high and direct temperature of the grill makes it possible to brown the surface of meats and roasts while locking in the juices to keep them tender. The grill is also highly recommended for dishes that require a high temperature on the surface: beef steaks, veal, rib steak, filets, hamburgers etc... Some grilling examples are included in the "Practical Cooking Advice" paragraph.

Multi function Oven cooking advice table (Up Oven)

Cooking modes	Foods	Weight (in kg)	Rack Position	Pre-heating time (minutes)	Recommended temperature	Cooking time (minutes)
Traditional Oven	Duck	1	3	15	200	65-75
	Roast veal or beef	1	3	15	200	70-75
	Pork roast	1	3	15	200	70-80
	Biscuits (short pastry)	-	3	15	180	15-20
	Tarts	1	3	15	180	30-35
Baking Mode	Tarts	0.5	3	15	180	20-30
	Fruit cakes	1	2 or 3	15	180	40-45
	Plum cake	0.7	3	15	180	40-50
	Sponge cake	0.5	3	15	160	25-30
	Stuffed pancakes (on 2 racks)	1.2	2 and 4	15	200	30-35
	Small cakes (on 2 racks)	0.6	2 and 4	15	190	20-25
	Cheese puffs (on 2 racks)	0.4	2 and 4	15	210	15-20
	Cream puffs (on 3 racks)	0.7	1 and 3 and 5	15	180	20-25
	Biscuits (on 3 racks)	0.7	1 and 3 and 5	15	180	20-25
Meringues (on 3 racks)	0.5	1 and 3 and 5	15	90	180	
Multi-cooking	Pizza (on 2 racks)	1	2 and 4	15	230	15-20
	Lasagne	1	3	10	180	30-35
	Lamb	1	2	10	180	40-45
	Roast chicken + potatoes	1+1	2 and 4	15	200	60-70
	Mackerel	1	2	10	180	30-35
	Plum cake	1	2	10	170	40-50
	Cream puffs (on 2 racks)	0.5	2 and 4	10	190	20-25
	Biscuits (on 2 racks)	0.5	2 and 4	10	180	10-15
	Sponge cake (on 1 rack)	0.5	2	10	170	15-20
	Sponge cake (on 2 racks)	1	2 and 4	10	170	20-25
	Savoury pies	1.5	3	15	200	25-30
Pizza Mode	Pizza	0.5	3	15	220	15-20
	Roast veal or beef	1	2	10	220	25-30
	Chicken	1	2 or 3	10	180	60-70
Mini grill	Grill cooking					
	Toast	n.°4	4	-	-	10
	Pork chops	1.5	4	-	-	30
	Mackerel	1.1	4	-	-	35
Maxi grill	Soles and cuttlefish	0.7	4	-	Max	10-12
	Squid and prawn kebabs	0.6	4	-	Max	8-10
	Cuttlefish	0.6	4	-	Max	10-15
	Cod filet	0.8	4	-	Max	10-15
	Grilled vegetables	0.4	3 or 4	-	Max	15-20
	Veal steak	0.8	4	-	Max	15-20
	Sausages	0.6	4	-	Max	15-20
	Hamburgers	0.6	4	-	Max	10-12
	Mackerels	1	4	-	Max	15-20
	Toasted sandwiches (or toast)	4 and 6	4	-	Max	3-5
Gratin	Grilled chicken	1.5	2	10	200	55-60
	Cuttlefish	1.5	2	10	200	30-35

Conventional Oven cooking advice table (down Oven)

Cooking modes	Foods	Weight (in kg)	Rack position	Preheating time (min)	Recommended Temperature (°C)	Cooking time (minutes)
Traditional	Lasagne	2.5	2	5	200	45-50
	Cannelloni	2.5	3	5	200	30-35
	Baked pasta	2.0	3	5	200	30-35
	Veal	1.7	2	10	180	60-70
	Chicken	1.5	3	10	200	80-90
	Duck	1.8	3	10	180	90-100
	Rabbit	2	3	10	180	70-80
	Pork	2.1	3	10	180	70-80
	Lamb	1.8	3	10	180	70-80
	Mackerel	1.1	2	5	180	30-40
	Mackerel	1.5	2	5	180	30-35
	Trout baked in foil	1	2	5	180	25-30
	Neapolitan-style pizza	1	2	15	220	15-20
	Biscuits and small cakes	0.5	3	10	180	10-15
	Sweet unleavened flans and desserts	1.1	3	10	180	25-30
	Savoury pies	1	3	10	180	30-35
	Leavened cakes	0.5	3	10	160	25-30
Fruit cakes	1	3	10	170	25-30	
PASTRY OVEN	Perfecting cooking					
Mini Grill	Sole and cuttlefish	1	4	5	Max	8
	Squid and prawn kebabs	1	4	5	Max	4
	Cod fillet	1	4	5	Max	10
	Grilled vegetables	1	3/4	5	Max	8-10
Maxi Grill	Veal steak	1	4	5	Max	15-20
	Chops	1.5	4	5	Max	20
	Hamburgers	1	3	5	Max	7
	Mackerel	1	4	5	Max	15-20
	Toast	4 pcs	4	5	Max	5
	With the rotisserie spit					
	Spit-roast veal	1.0	-	5	Max	70-80
Spit-roast chicken	2.0	-	5	Max	70-80	

Precautions and tips

GB

! This appliance has been designed and manufactured in compliance with international safety standards. The following warnings are provided for safety reasons and must be read carefully.

General safety

- The appliance was designed for domestic use inside the home and is not intended for commercial or industrial use.
- The appliance must not be installed outdoors, even in covered areas. It is extremely dangerous to leave the appliance exposed to rain and storms.
- Do not touch the appliance with bare feet or with wet or damp hands and feet.
- The appliance must be used by adults only for the preparation of food, in accordance with the instructions provided in this booklet.
- The instruction booklet accompanies a class 1 (insulated) or class 2 - subclass 1 (recessed between 2 cupboards) appliance.
- Do not touch the heating elements or certain parts of the oven door when the appliance is in use; these parts become extremely hot. Keep children well away from the appliance.
- Make sure that the power supply cables of other electrical appliances do not come into contact with the hot parts of the oven.
- The openings used for the ventilation and dispersion of heat must never be covered.
- Always use oven gloves when placing cookware in the oven or when removing it.
- Do not use flammable liquids (alcohol, petrol, etc...) near the appliance while it is in use.
- Do not place flammable material in the lower storage compartment or in the oven itself. If the appliance is switched on accidentally, they could catch fire.
- The internal surfaces of the compartment (where present) may become hot.
- Always make sure the knobs are in the "0" position when the appliance is not in use.
- When unplugging the appliance, always pull the plug from the mains socket; do not pull on the cable.

- Never perform any cleaning or maintenance work without having disconnected the appliance from the electricity mains.
- If the appliance breaks down, under no circumstances should you attempt to perform the repairs yourself. Repairs carried out by inexperienced persons may cause injury or further malfunctioning of the appliance. Contact Assistance.
- Do not rest heavy objects on the open oven door.

Disposal

- When disposing of packaging material: observe local legislation so that the packaging may be reused.
- The European Directive 2002/96/EC relating to Waste Electrical and Electronic Equipment (WEEE) states that household appliances should not be disposed of using the normal solid urban waste cycle. Exhausted appliances should be collected separately in order to optimise the cost of re-using and recycling the materials inside the machine, while preventing potential damage to the atmosphere and to public health. The crossed-out dustbin is marked on all products to remind the owner of their obligations regarding separated waste collection. For further information relating to the correct disposal of exhausted household appliances, owners may contact the public service provided or their local dealer.

Respecting and conserving the environment

- You can help to reduce the peak load of the electricity supply network companies by using the oven in the hours between late afternoon and the early hours of the morning.
- Always keep the oven door closed when using the GRILL and GRATIN modes: This will achieve improved results while saving energy (approximately 10%).
- Check the door seals regularly and wipe them clean to ensure they are free of debris so that they adhere properly to the door, thus avoiding heat dispersion.

Switching the appliance off

Disconnect your appliance from the electricity supply before carrying out any work on it.

Cleaning the appliance

! Never use steam cleaners or pressure cleaners on the appliance.

- The stainless steel or enamel-coated external parts and the rubber seals may be cleaned using a sponge that has been soaked in lukewarm water and neutral soap. Use specialised products for the removal of stubborn stains. After cleaning, rinse well and dry thoroughly. Do not use abrasive powders or corrosive substances.
- The hob grids, burner caps, flame spreader rings and burners may be removed to make cleaning easier; wash them in hot water and non-abrasive detergent, making sure all burnt-on residue is removed before drying them thoroughly.
- Clean the terminal part of the flame failure safety devices* frequently.
- The inside of the oven should ideally be cleaned after each use, while it is still lukewarm. Use hot water and detergent, then rinse well and dry with a soft cloth. Do not use abrasive products.
- Clean the glass part of the oven door using a sponge and a non-abrasive cleaning product, then dry thoroughly with a soft cloth. Do not use rough abrasive material or sharp metal scrapers as these could scratch the surface and cause the glass to crack.
- The accessories can be washed like everyday crockery, and are even dishwasher safe.
- Do not close the cover when the burners are alight or when they are still hot.

Inspecting the oven seals

Check the door seals around the oven regularly. If the seals are damaged, please contact your nearest Authorised After-sales Service Centre. We recommend that the oven is not used until the seals have been replaced.

Replacing the oven light bulb

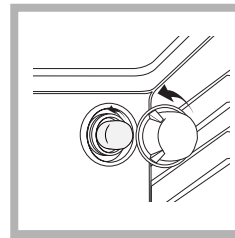

1. After disconnecting the oven from the electricity mains, remove the glass lid covering the lamp socket (*see figure*).
2. Remove the light bulb and replace it with a similar one: voltage 230 V, wattage 25 W, cap E 14.

3. Replace the lid and reconnect the oven to the electricity supply.

Gas tap maintenance

Over time, the taps may become jammed or difficult to turn. If this occurs, the tap must be replaced.

! This procedure must be performed by a qualified technician authorised by the manufacturer.

Assistance

! Never use the services of an unauthorised technician.

Please have the following information to hand:

- The type of problem encountered.
- The appliance model (Mod.).
- The serial number (S/N).

The latter two pieces of information can be found on the data plate located on the appliance.

Free Manuals Download Website

<http://myh66.com>

<http://usermanuals.us>

<http://www.somanuals.com>

<http://www.4manuals.cc>

<http://www.manual-lib.com>

<http://www.404manual.com>

<http://www.luxmanual.com>

<http://aubethermostatmanual.com>

Golf course search by state

<http://golfingnear.com>

Email search by domain

<http://emailbydomain.com>

Auto manuals search

<http://auto.somanuals.com>

TV manuals search

<http://tv.somanuals.com>