

Operating Instructions

HOB

GB

GB

English, 1

PI 604GB
PIM 604GB

Contents

Installation, 2-3

Positioning
Electrical connections

Description of the appliance, 4

Overall view

Precautions and tips, 5

General safety
Disposal
Practical Advice on Using the Electric Hot Plates

Maintenance and care, 6

Switching the appliance off
Cleaning the appliance
Technical data

Assistance, 7

 **INDESIT**

Installation

GB

! Before operating your new appliance please read this instruction booklet carefully. It contains important information for safe use, installation and care of the appliance.

! Please keep these operating instructions for future reference. Pass them on to possible new owners of the appliance.

Positioning

! Keep packaging material out of the reach of children. It can become a choking or suffocation hazard (see *Precautions and tips*).

! The appliance must be installed by a qualified person according to the instructions provided. Incorrect installation may damage property or cause harm to people or animals.

Built-in

It is possible to instal them next to furniture which is higher than the working board. For a correct installation of the cooking top the following precautions must be followed:

- The hob may be located in a kitchen, a kitonen/ diner or bed sitting room, but no in a bathroom or shower room.
- The hoods must be installed according to the requirements in the hood handbook.
- The dimensions of the cutout for the appliance must be those indicated in the figure. Clamps are provided to fasten the cooktop to counters measuring from 20 to 40 mm in thickness. To fasten the cooktop securely, it is recommended that all the clamps be used.

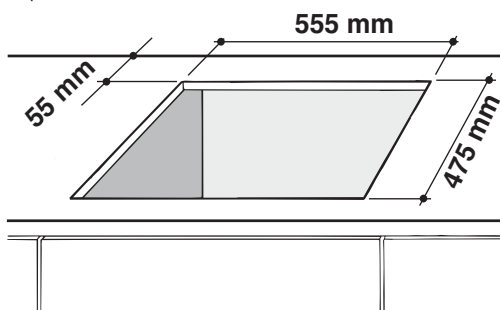

Fastening Clamps - Assembly Diagram

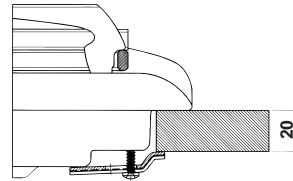

Clamp Position for
H=20mm top

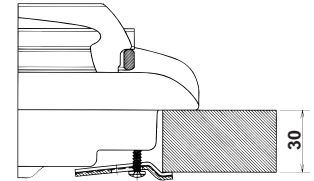

Clamp Position for
H=30mm top

Front

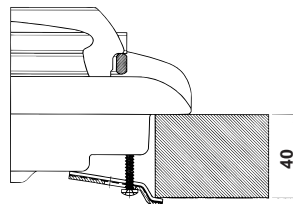

Clamp Position for
H=40mm top

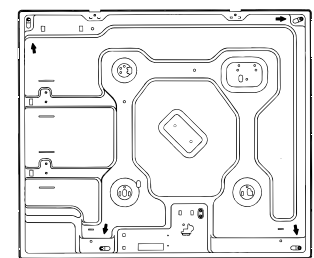

Back

! Use the clamps contained in the "accessory kit."

- In case a wooden panel should be fitted under the top for insulation, it will have be fitted at a minimum distance of 20 mm from the inferior part of the top.

Ventilation

When installing the cooktop above a built-in oven, the oven should be placed on two wooden strips; in the case of a joining cabinet surface, remember to leave a space of at least 45 x 560 mm at the back (see *picture*).

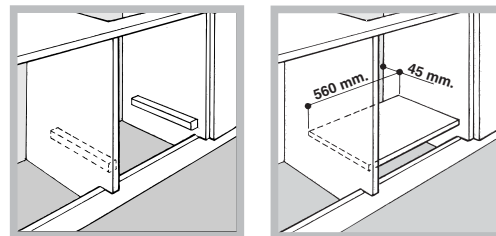

When installing on a built-in oven without forced ventilation, ensure that there are air inlets and outlets for ventilating the interior of the cabinet adequately (see *picture*).

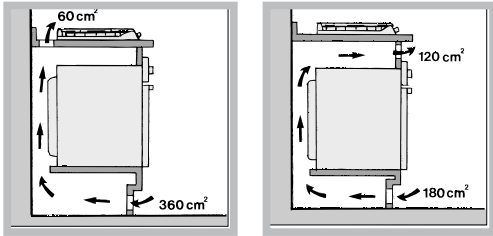

Electrical connection

The following installation procedure must be carried out by a qualified electrician.

! the cooker must be connected to the mains by a switched (double pole) cooker outlet correctly fused with a capacity appropriate to that shown on the hob Rating Plate. All electrical wiring from the consumer unit to the appliance, via the switched double pole cooker outlet, must be of an acceptable type and current rating as above. The supply cord, type H05 VV-F 3x2.5mm², must be positioned so that it never reaches at any point a temperature 50°C higher than the room temperature. The electrical installation must comply with the IEE Regulations, Building Regulation & local By-Lays.

! THIS APPLIANCE MUST BE EARTHED.

In the case of installation over a built-in electric oven the electrical hook-up of the stove top and that of the oven should be separate, for reasons of safety as well as for ease of eventual removal of the oven.

Supply cable installation

The electric hobs are supplied without cable. Use a cable:

H05 VV-F 3x2.5mm²

- Open the terminal box by removing the "V" screw and taking off the cover.
 - The wires in the mains lead are coloured in accordance with the following code:
Green & Yellow - **Earth "E"**
Blue - **Neutral "N"**
Brown - **Live "L"**
- Connect the wires in accordance with the following diagram

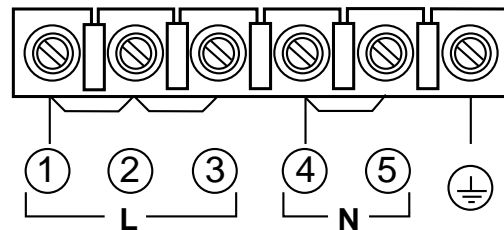

- Fix the cable in place with the "F" cable clamp, close the lid and fasten it with the "V" screw (see picture).

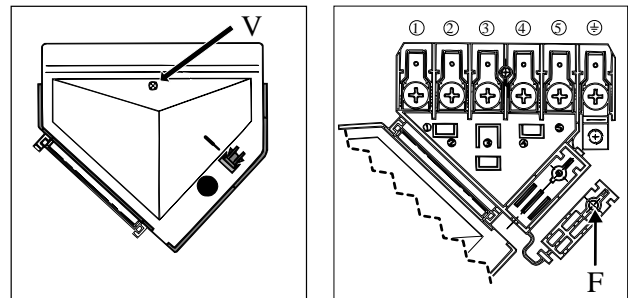

Description of the appliance

GB

Overall view

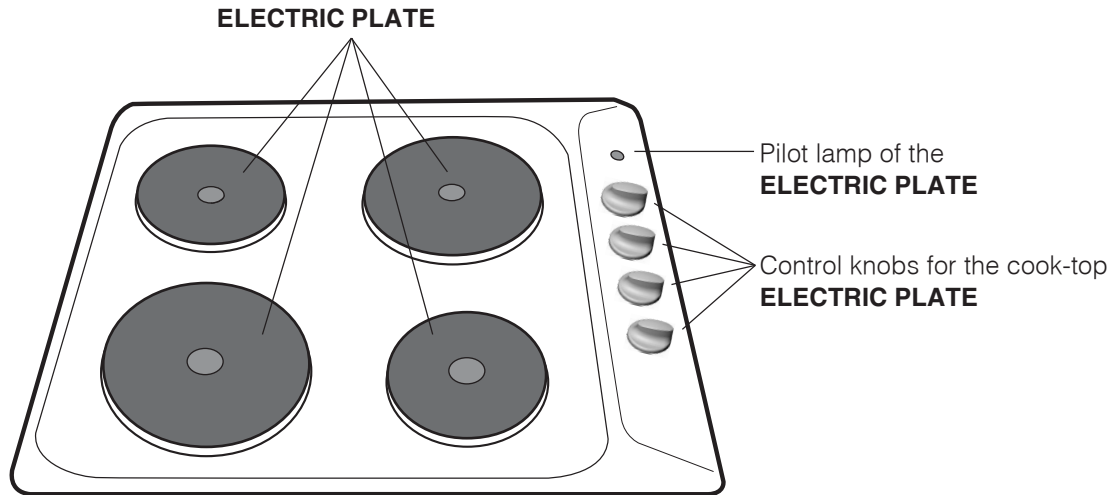

- The **ELECTRIC PLATE** vary in diameter and power: "normal" and "fast". The latter can be identified by a red boss in the center of the hot plate itself.

! The position of the corresponding electric hot plate is indicated on each control knob.

- The **ELECTRIC PLATE ON** indicator light switches on whenever the knob is moved from the 'off' position.

- The **ELECTRIC PLATE** control knob is a device used to regulate power. The knob may be turned clockwise or anti-clockwise and set to six different positions:

Setting	Normal or Fast Plate
0	Off
1	Low
2 - 5	Medium
6	High

! Please refer to the "Practical advice on using the appliance" section for a list of the relative positions and their recommended uses.

! This appliance has been designed and manufactured in compliance with international safety standards. The following warnings are provided for safety reasons and must be read carefully.

General safety

- **This manual is for a class 3 built-in cooktop.**
- **These instructions are only valid for the countries the symbols for which appear on the manual and the serial plate.**
- This appliance is designed for non-professional use in the home.
- This appliance was designed for domestic use inside the home and is not intended for commercial or industrial use.
- Do not touch the appliance with bare feet or with wet or damp hands and feet.
- **The appliance must be used by adults only for the preparation of food, in accordance with the instructions outlined in this booklet. Any other use of the appliance (e.g. for heating the room) constitutes improper use and is dangerous. The manufacturer may not be held liable for any damage resulting from improper, incorrect and unreasonable use of the appliance.**
- Ensure that power supply cables of other electrical appliances do not come into contact with the hot parts of the hob.
- The openings and slots used for ventilation and heat dispersion must never be covered.
- Make sure the knobs are in the “●/”○” position when the appliance is not in use.
- When unplugging the appliance always pull the plug from the mains socket, do not pull on the cable.
- Never carry out any cleaning or maintenance work without having unplugged the plug from the mains.
- In the case of a malfunction, under no circumstances should you attempt to repair the appliance yourself. Repairs carried out by inexperienced persons may cause injury or further malfunctioning of the appliance. Contact a Service Centre (*see Assistance*).
- Always make sure pan handles are turned towards the centre of the hob in order to avoid accidental burns.
- Do not leave the electric plate switched on without a pan placed on it.
- Do not use cookware with uneven or deformed bottoms.
- The appliance should not be operated by people (including children) with reduced physical, sensory or mental capacities, by inexperienced individuals or by anyone who is not familiar with the product. These individuals should, at the very least, be supervised by someone who assumes

responsibility for their safety or receive preliminary instructions relating to the operation of the appliance.

- Do not let children play with the appliance.
- **The appliance is not intended to be operated by means of an external timer or separate remote-control system.**

Disposal

- When disposing of packaging material: observe local legislation so that the packaging may be reused.
- The European Directive 2002/96/EC on Waste Electrical and Electronic Equipment (WEEE), requires that old household electrical appliances must not be disposed of in the normal unsorted municipal waste stream. Old appliances must be collected separately in order to optimise the recovery and recycling of the materials they contain and reduce the impact on human health and the environment. The crossed out “wheeled bin” symbol on the product reminds you of your obligation, that when you dispose of the appliance it must be separately collected. Consumers should contact their local authority or retailer for information concerning the correct disposal of their old appliance.

Practical Advice on Using the Electric Hot Plates

In order to avoid heat loss and damage to the hot plate, use cookware with a flat bottom the diameter of which is not less than that of the hot plate.

Setting	Setting
0	Off
1	Cooking vegetables, fish
2	Cooking potatoes (using steam) soups, chickpeas, beans.
3	Continuing the cooking of large quantities of food, minestrone.
4	For roasting (average)
5	For roasting (above average)
6	For browning and reaching a boil in a short time

! Before using the hot plates for the first time, you should heat them at maximum temperature for approximately 4 minutes, without any pans. During this initial stage, their protective coating hardens and reaches its maximum resistance.

Maintenance and care

GB

Switching the appliance off

Disconnect your appliance from the electricity supply before carrying out any work on it.



Cleaning the appliance

! Do not use abrasive or corrosive detergents, stain removers, anti-rust products, powder detergents or sponges with abrasive surfaces: these may scratch the surface.

! Never use steam cleaners or pressure cleaners on the appliance.

- It is usually enough to wash the hob with a damp sponge and dry it with absorbent kitchen roll.
- The electric hobs should be cleaned using a damp cloth and then rubbed with oil while still warm.
- Stainless steel may become marked if it comes into contact with very hard water or harsh detergents (containing phosphorous) for long periods of time. After cleaning, it is advisable to rinse thoroughly and dry. It is also recommended that drops of water be dried.

Technical characteristic

DATA PLATE	
Electrical section	voltage: 230V ~ 50/60Hz Max power 7000 W
 	This appliance conforms to the following European Economic Community directives: - 2006/95/EEC of 12/12/06 (Low Voltage) and subsequent amendments; - 2004/108/EEC of 15/12/04 (Electromagnetic Compatibility) and subsequent amendments; - 93/68/EEC of 22/07/93 and subsequent amendments. - 2002/96/EC and subsequent amendments.

Communicating:

- appliance model (Mod.)
- serial number (S/N)

This information is found on the data plate located on the appliance and/or on the packaging.

GB



Guarantee

12 months Parts and Labour Guarantee

Your appliance has the benefit of our manufacturer's guarantee, which covers the cost of breakdown repairs for twelve months from the date of purchase.

This gives you the reassurance that if, within that time, your appliance is proven to be defective because of either workmanship or materials, we will, at our discretion, either repair or replace the appliance at no cost to you.

This guarantee is subject to the following conditions:

- The appliance has been installed and operated correctly and in accordance with our operating and maintenance instructions.
- The appliance is used only on the electricity or gas supply printed on the rating plate.
- The appliance has been used for normal domestic purposes only.
- The appliance has not been altered, serviced, maintained, dismantled, or otherwise interfered with by any person not authorised by us.
- Any repair work must be undertaken by us or our appointed agent.
- Any parts removed during repair work or any appliance that is replaced become our property.
- The appliance is used in the United Kingdom or Republic of Ireland.

The guarantee does not cover:

- Damage resulting from transportation, improper use, neglect or interference or as a result of improper installation.
- Replacement of any consumable item or accessory. These included but not limited to: plugs, cables, batteries, light bulbs, fluorescent tubes and starters, covers and filters.
- Replacement of any removable parts made of glass or plastic.

THIS GUARANTEE WILL NOT APPLY IF THE APPLIANCE HAS BEEN USED IN COMMERCIAL OR NON-DOMESTIC PREMISES.

5 Year Parts Guarantee

Indesit also offers you a free 5 year parts guarantee. This additional guarantee is conditional on you registering your appliance with us and the parts being fitted by one of our authorised engineers. There will be a charge for our engineer's time. To activate the extra parts warranty on your appliance, simply call our registration line on **08448 24 24 24 (Republic of Ireland 01 230 0800)**

Extended Guarantees

We offer a selection of protection plans that enable you to fully cover yourself against the expense of repair bills for the life of your policy. To find the ideal plan for you please call our advice line on **08448 226 226 (Republic of Ireland 01 230 0233)**.

Free Helpdesk Service

We have a dedicated team who can provide free advice and assistance with your appliance if you experience any technical difficulties within the first 90 days of ownership. Simply call our Indesit Service Hotline on **08448 224 224 (Republic of Ireland 0818 313 413)** for telephone assistance, or, where necessary, to arrange for an engineer to call.



After Sales Service

No one is better placed to care for your Indesit appliance during the course of its working life than us – the manufacturer.

Essential Contact Information

Indesit Service

We are the largest service team in the UK and Ireland offering you access to 400 skilled telephone advisors and 1000 fully qualified engineers on call to ensure you receive fast, reliable, local service.

UK: 08448 224 224
Republic of Ireland: 0818 313 413
www.indesitservice.co.uk

Please note: Our advisors will require the following information:

Model number:

Serial number:

Parts and Accessories

We supply a full range of genuine replacement parts as well as accessory products that protect and hygienically clean your appliance to keep it looking good and functioning efficiently throughout its life.

UK: 08448 225 225
Republic of Ireland: 0818 313 413
www.indesitservice.co.uk

Appliance Registration

We want to give you additional benefits of Indesit ownership. To activate your free 5 year parts guarantee you must register your appliance with us.

UK: 08448 24 24 24
Republic of Ireland: 01 230 0800
www.indesitservice.co.uk

Indesit Company UK Ltd. Morley Way, Peterborough, PE2 9JB
Indesit Company Unit 49 Airways Industrial Estate, Dublin 17

Recycling and Disposal Information

As part of Indesit's continued commitment to helping the environment, Indesit reserves the right to use quality, recycled components to keep down customer costs and minimise material wastage.

Please dispose of packaging and old appliances carefully. To minimise the risk of injury to children, remove the door, plug, and cut the mains cable off flush with the appliance. Dispose of these parts separately to ensure that the appliance can no longer be plugged into mains socket, and the door cannot be locked shut.

Free Manuals Download Website

<http://myh66.com>

<http://usermanuals.us>

<http://www.somanuals.com>

<http://www.4manuals.cc>

<http://www.manual-lib.com>

<http://www.404manual.com>

<http://www.luxmanual.com>

<http://aubethermostatmanual.com>

Golf course search by state

<http://golfingnear.com>

Email search by domain

<http://emailbydomain.com>

Auto manuals search

<http://auto.somanuals.com>

TV manuals search

<http://tv.somanuals.com>