



Cooker Maxioven

GB Instructions for installation and use

1

Congratulations on choosing an iNDESIT appliance, which you will find is dependable and easy to use. We recommend that you read this manual for best performance and to extend the life of your appliance. Thank you.

SAFETY PRECAUTIONS

THESE INSTRUCTIONS ARE ONLY VALID FOR THE COUNTRIES OF DESTINATION WHOSE SYMBOLS ARE SHOWN IN THE BOOKLET AND THE APPLIANCE RATING PLATE.

1. **This appliance has been designed for private, non-professional use in normal dwellings.**
2. **Read the recommendations in this instruction booklet carefully, as they give important advice regarding safe installation, use and maintenance. Keep this booklet in a safe place for further reference when required.**
3. Oven accessories which may come into contact with food are made of materials which comply with the contents of EEC Regulation 89/109 of 21.12.88 and national regulations in force.
4. After having removed the packaging, check that the appliance is intact. If in doubt, do not use the appliance and contact professionally qualified personnel.
5. Some parts are covered with a removable scratch-proof film. Before using the appliance the film should be removed and the underlying part cleaned with a cloth and a non-abrasive household cleaning product. When switching on for the first time, it is advisable to heat the empty oven at maximum temperature for about 30 minutes to eliminate any residue from manufacture.
6. All installation and adjustment operations should be carried out by qualified technicians in accordance with current regulations. Specific indications are given in the "instructions for the installer" paragraph.
7. Before connecting the appliance, make sure that the data on the rating plate (situated on the rear part of the appliance and on the last page of the instruction booklet) correspond to those of the mains electricity and gas supplies.
8. During operation, the oven glass door and adjacent parts of the appliance become hot. Make sure, therefore, that children do not touch the appliance.
For greater safety, an additional child-safety device is available from our Head Office and our Authorised Service Centres (see enclosed list). When ordering this, please give the code: **BAB** - followed by the **appliance model**. The model is stamped on the plate which is visible on the front part of the oven upon opening the door.
9. Check that the capacity of the electrical system and the power outlets are suitable for the maximum power of the appliance, indicated on the rating plate. If in doubt, consult a professionally qualified technician.
10. Periodically check the condition of the gas connection pipe and have it replaced by a qualified technician as soon as it shows any signs of wear or anomaly.
11. Under no circumstances should the user replace the power supply cable or the gas connection pipe of this appliance. In the event of damage or the necessity for replacement, only contact an authorised service centre.
12. Do not leave the appliance plugged in if it is not in use. Switch off the main switch and gas supply when you are not using the cooker.
13. The burners and the cast-iron pan supports remain hot for a long time after use. Take care not to touch them.
14. To avoid accidental spillage do not use cookware with uneven or deformed bottoms on the burners.
15. Never use flammable liquids such as alcohol or gasoline, etc. near the appliance when it is in use.
16. **This appliance conforms to the following European Economic Community directives:**
 - 73/23/EEC of 19/02/73 (Low Voltage) and subsequent modifications;
 - 89/336/EEC of 03/05/89 (Electromagnetic Compatibility) and subsequent modifications;
 - 90/396/EEC of 29/06/90 (Gas) and subsequent modifications;
 - 93/68/EEC of 22/07/93 and subsequent modifications.

COOKER DESCRIPTION

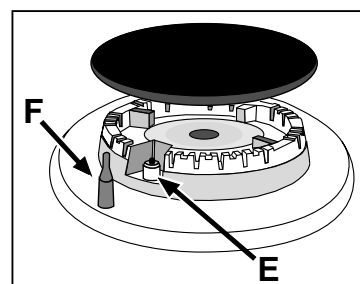
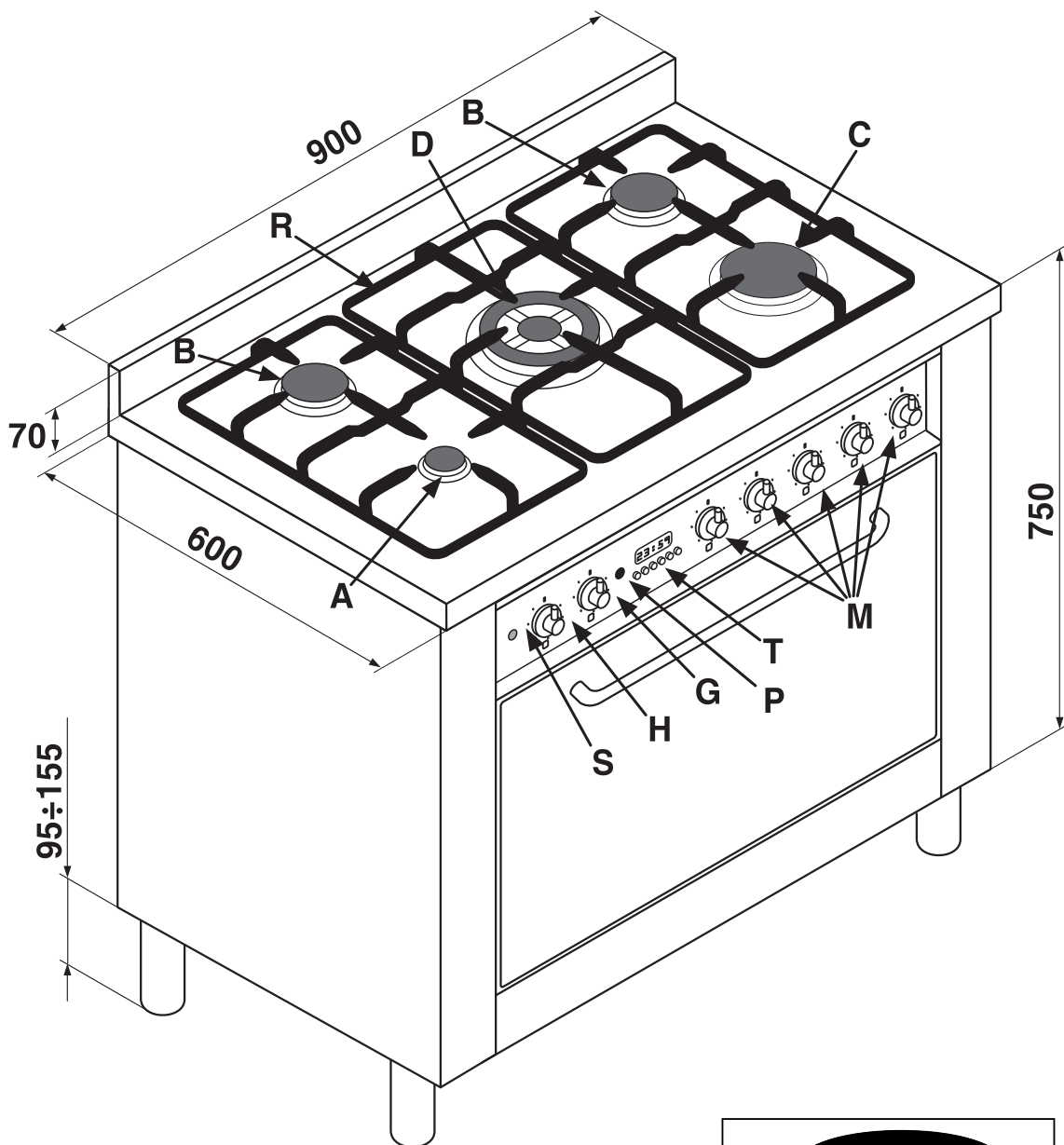

- A Auxiliary gas burner
- B Semi-rapid gas burner
- C Rapid gas burner
- D Triple ring gas burner
- R Support Grid for Cookware
- M Control Knobs for Gas Burners
- P Ignition Pushbutton for gas burners
- E Ignitor for Gas Burners
- F Safety Device - Activates if the flame accidentally goes out (spills, drafts, etc.), interrupting the delivery of gas to the burner.
- T Minute minder
- S Electric oven operation indicator light
- G Electric oven selector knob (cooking function selection)
- H Electric oven thermostat knob (temperature selection)

INSTRUCTIONS FOR USE

HOB OPERATION

The burners are fitted with automatic ignition and a thermocouple safety device, which automatically cuts off the gas from the burner in a few seconds if the flame accidentally goes out during operation.

The burners differ in size and power. Choose the most appropriate one for the diameter of the cookware being used. Each burner can be regulated with the corresponding control knob "M" by using one of the following settings:

Off ●
 High flame 🔻
 Low flame 🔻

The symbols  near the knobs show the position of the relative burner on the hob.

To **ignite a burner**, proceed as follows:

- turn the relative knob counter-clockwise until the pointer is on the high-flame symbol;
- press the knob down fully and activate the automatic gas ignition by pushing at the same time the button "P" marked with the symbol  ;
- keep the knob pressed down for about 10 seconds with the flame lit to allow the safety thermocouple to be heated;
- release the knob, checking that the flame is stable. If it is not, repeat the operation.

For minimum power, turn the knob towards the low flame symbol. Intermediate positions are possible by simply putting the knob anywhere between the high and the low flame symbol. To turn off the burner, turn the knob clockwise to the off position "●".

Important:

- Do not activate the automatic ignition device for more than 15 consecutive seconds.
- Difficulty in ignition is sometimes due to air inside the gas duct.
- If a burner flame accidentally goes out, the gas continues to exit for a few moments before the safety device activates. Turn the control knob to the off position and do not attempt ignition again for at least 1 minute, thereby letting the gas disperse, which could otherwise be a danger.
- When the appliance is not in operation, check that the knobs are in the off position "●". The main gas supply cut-off cock should also be closed.

Using the burners

To obtain maximum efficiency from the burners, it is advisable to only use pans with a diameter suitable for the burner being used, so that the flame does not extend beyond the pan base (see following table).

Burner	Diameter of the pan in cm.
Auxiliary A	from 6 to 14
Semi-rapid B	from 15 to 20
Rapid C	from 21 to 30
Triple ring D	from 24 to 30

When a liquid starts boiling, it is advisable to turn the flame down just enough to keep the liquid simmering.

The hob is fitted with a **pan reducing support** (fig.1), which should only be used on the auxiliary burner "A"

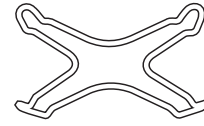













fig.1

MULTI-FUNCTION OVEN

The oven offers nine combinations of heating elements; so the most suitable combination may therefore be chosen for each dish, with convincing results.



By turning the selector knob "G" marked with the symbol , different cooking modes are obtained, as shown in the following table:

Symbol	Function	Power
0	0) Off	-
	1) Top + Bottom heating elements	2350 W
	2) Bottom heating element	1300 W
	3) Top heating element	1050 W
	4) Grill heating element	2000 W
	5) Maxigrill (Top + Grill heating elements)	3050 W
	6) Maxigrill (Top + Grill heating elements) + fan	3050 W
	7) Bottom heating element + Fan	1300 W
	8) Rear round heating element + Fan	2800 W
	9) Fast defrosting	50 W





After having selected the heat source, put the **thermostat** knob "H" (marked with the symbol ) onto the temperature required.

- For traditional cooking (roasts, biscuits, etc.) in **conventional** mode use the  mode (hot above + below).

Only put the food to be cooked into the oven when it has reached the selected temperature and preferably use just one shelf for cooking.

To provide heat only to the bottom or the top part of the dishes, turn the selector to the position  (hot below) or  (hot above);

- With this  (**fan assisted**) mode heat is transmitted to the food through pre-heated air made to circulate inside the oven by a fan. The oven heats up very quickly so the food to be cooked may be put into the oven as soon as it is switched on. Cooking is also possible simultaneously on two shelves.

- The “**fast defrosting**” function  uses no heating elements, just the oven light and the fan.
- **Grill** operation: a high heat output is used for grilling, so that the surface of the food is immediately browned; this is particularly indicated for meats which should remain tender on the inside. To grill, turn the selector knob “**G**” to one of these positions:  (grill),  (maxigrill),  (maxigrill + fan)

During grilling, do not set the thermostat knob to above 200 °C and keep the oven door closed.

Oven light

The oven light comes on automatically when the selector knob  is turned to any of its positions.

Indicator light "S"

(figure a on page 2) It indicates that the oven is heating up. When the light goes out, the required temperature has been reached inside the oven.

When the light alternately comes on and goes out, it means that the thermostat is working properly to maintain the oven temperature.

Minute minder "T"

This is a buzzer timer situated on the control panel and is suitable for timing up to a max. of 60 minutes.



Turn the knob with the symbol  until the pointer is aligned with the required time. When the set time has elapsed, a buzzer sounds (it does not turn the oven off).

It is advisable to turn the knob to 60 and then back to the time required, even if this is less than 60 minutes.

See pages 5-6 for the cooking times and temperatures required for different foods.

Spit - Rotisserie

Insert the meat to be cooked along the length of the spit rod, securing it with the special adjustable forks (fig. 2).

Introduce the supports “**A**” and “**B**” (fig. 3) into the holes in the drip tray “**E**”, rest the rod groove on the seat “**C**” and insert the oven rack into the lowest guide of the oven; now insert the spit rod into the relative hole, moving the groove forward into seat “**D**”. Start the rotisserie by turning the selector knob to one of the following positions:   

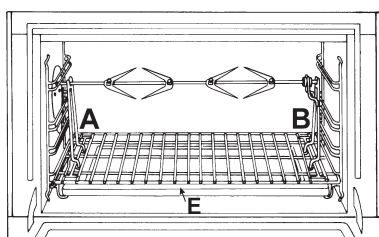

fig.2

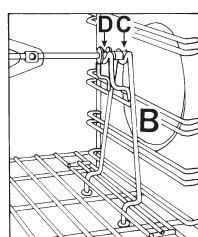

fig.3

CLEANING AND MAINTENANCE

To ensure a long life cycle for the appliance, it is essential to carry out a thorough general clean frequently, taking into account that:

- **The appliance should be disconnected from the mains supply before starting cleaning operations.**
- Avoid cleaning appliance parts when they are still warm.
- The enamelled, chromed or glass parts must be washed with warm water without using abrasive powders or corrosive substances which could ruin them.
- The inside of the oven should be cleaned every time it is used with hot water and detergent; rinse and dry thoroughly.
- The steel parts and especially the areas with the screen-printed symbols should not be cleaned with diluents or abrasive detergents. It is advisable to use only a damp cloth with tepid water and washing up liquid. After cleaning, the surfaces should be rinsed thoroughly with water and then dried well.
- Avoid leaving acidic liquids (vinegar, lemon juice, aggressive detergents, etc.) on enamelled or varnished parts.
- The removable parts of the burners on the hob should be washed frequently with warm water and soap, making sure to remove any caked-on substances. Check that the gas outlet slits are not clogged. Dry the burners carefully before using them again.
- Clean the end part of the automatic glow plug ignitors of the hob frequently.

Greasing the taps

As time passes, a tap may lock or become difficult to turn. In this case it will be necessary to clean inside and replace the grease. **This procedure must be performed by a technician authorized by the manufacturer.**

Changing the oven lightbulb

Make sure that the appliance is disconnected from the electricity supply.

Unscrew the glass protective cover from inside the oven, unscrew the lightbulb and replace it with an identical one suitable for high temperatures (300°C) and with the following characteristics:

- Voltage 230 V
- Wattage 15 W
- Type E 14.

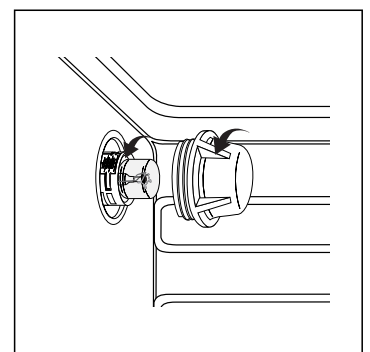

COOKING PROGRAMMER

The electronic programmer has the function of automatically switching on the oven (at the required time) and switching it off at the end of the set cooking time. The 4 figure luminous display showing the actual time and the programming times, also shows the current state of the oven by means of the following symbols:

Oven on 

Minute minder 



Automatic programme **AUTO**

Point  (this divides the hour from the minutes on the display)



All the functions may be programmed for a total of 23 h and 59 min. Maximum cooking time is 10 hours.

Adjusting the clock

(At installation, after power failures, clock in advance or behind).





Select manual mode by pressing key , adjust the hour and minutes using the  and  keys.

Manual oven mode (Programming excluded)





Press the key ; and the oven is switched on, the **AUTO** symbol goes out and the  (oven on) symbol comes on. This operation erases any set programme.

Semi-automatic oven mode









1st example: start in manual cooking mode - programmed cooking time.

- Put the food to be cooked in the oven.
- Press the  key (duration) and adjust the cooking time using the  and  keys: the oven switches on, the **AUTO** and  (oven on) symbols light up.
- Turn the selector and the thermostat knobs onto the required function and temperature respectively.
- At the end of the set cooking time, the oven is automatically switched off, the symbol  (oven on) goes out and the **AUTO** symbol blinks; an acoustic signal sounds.

2nd example: start with manual cooking mode - end with programmed cooking mode.



- Put the food to be cooked in the oven.
- Press the  key (end of cooking) and adjust the end of cooking time using the  and  keys: the oven switches on, the **AUTO** and  symbols light up.
- Turn the selector and the thermostat knobs onto the required function and temperature respectively.
- At the end of cooking, the oven is automatically switched off, the  symbol (oven on) goes out and the **AUTO** symbol blinks; an acoustic signal sounds.

Automatic oven mode (programmed cooking duration and end)

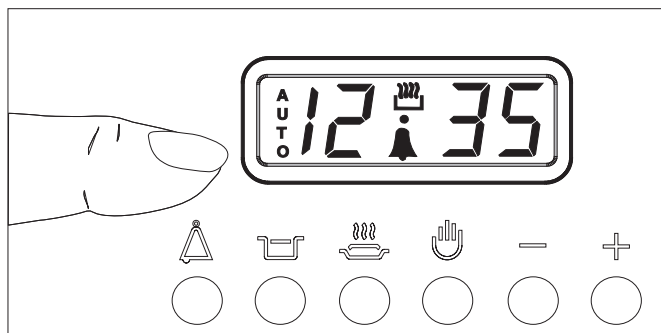

- Put the food to be cooked in the oven.
- Press the key  (Duration) and adjust the cooking time using the  and  keys: the **AUTO** and  (oven on) symbols light up (the oven switches on).
- Press the key  (end of cooking) and adjust the end of cooking time using the  and  keys: the  symbol





goes out (the oven switches off).

- Turn the selector and the thermostat knobs onto the required function and temperature respectively.
- The programmer automatically sets the start of cooking time, which is shown by the symbol  (oven on) coming on. When the cooking time has elapsed, the oven is automatically switched off, the  (oven on) symbol goes out and the **AUTO** symbol blinks; an acoustic signal sounds.



Minute minder

Press the  key (minute minder) and set the time required using the  and  keys. An acoustic signal sounds at the end of the programme.

Buzzer

The buzzer emits a sound for 7 minutes after the end of the selected programme; it may be stopped by pressing any function key. It is possible to choose 3 different types of acoustic signal. By pressing the  key the actual signal tone appears. Now, within 7 seconds, every further press of the  key changes the signal tone.

Programme control

Press the key  for the remaining time to be displayed, and the key  to check the end of cooking time.

Erasing programmes

Once a programme has been carried out, it is automatically erased; it can also be cancelled by pressing the key  (manual).

COOKING TIPS

Cooking times may change according to the nature of the foods, their homogeneity and their volume. When cooking a certain food for the first time, it is advisable to choose the lowest values in the cooking time range given in the table and then increase them if necessary.

CONVENTIONAL oven cooking

Type of dish	Temperature °C	Cooking time (minutes)	Type of dish	Temperature °C	Cooking time (hours)
Pastries and cakes			Meat		
Fruit pie	130	60-70	Turkey (4-8 kg.)	160	3-4½
Meringues	130	30-40	Goose (4-5 kg.)	160	4-4½
Sponge cake	150	20-30	Duck (2-4 kg.)	170	1½-2½
Angel cake	160	40-50	Capon (2½-3 kg.)	170	2-2½
Madeira cake	160	40-50	Braised beef (1-1½ kg.)	160	3-3½
Chocolate cake	170	30-40	Leg of lamb	160	1-1½
Flat sweet loaf	170	40-50	Roast hare (2 kg.)	160	1-1½
Puffs	200	15-20	Roast pheasant	160	1-1½
Flaky pastry biscuits	200	15-20	Chicken (1-1½ kg.)	170	1-1½
Mille feuilles	200	15-20			
Short pastry	200	15-20	Fish	200	15-25 minutes

GRILLING

Type of dish	Cooking time (minutes)	Position of shelf
Chops (0.5 kg.)	60	3rd guide rail
Sausages	15	2nd guide rail
Grilled chicken (1 kg)	60	1st guide rail
Veal on the spit (0.6 kg.)	60	-
Chicken on the spit (1 kg.)	60	-

The 1st guide rail is understood as being the lowest position.

FAN ASSISTED cooking

Type of dish	Guide rail No. from bottom	Quantity kg.	Temperature °C	Time (minutes)
Pastries and cakes				
* With beaten mix, in mould	1-3	1	175	60
* With beaten mix, without mould	1-3-4	1	175	50
Short pastry, flan base	1-3-4	0.5	175	30
Short pastry with wet filling	1-3	1.5	175	70
Short pastry with dry filling	1-3-4	1	175	45
* With natural leavened mix	1-3	1	175	50
Small pastries and cakes	1-3-4	0.5	160	30
Meat				
Roasts under grill				
Veal	2	1	180	60
Beef	2	1	180	70
English roast beef	2	1	220	50
Pork	2	1	180	70
Chicken	2	1-1.5	200	70
Roasts on tray				
Veal	1-3	1	160	80
Beef	1-3	1	160	90
Pork	1-3	1	160	90
Chicken	1-3	1-1.5	180	90
Turkey slices	1-3	1.5	180	120
Duck	1-3	1-1.5	180	120
Casseroles				
Braised beef	1	1	175	120
Braised veal	1	1	175	110
Fish				
Fillets, steaks, cod hake, sole	1-3	1	180	30
Mackerel, turbot, salmon	1-3	1	180	45
Oysters	1-3		180	20
Timbales				
Baked pasta dish	1-3	2	185	60
Vegetable pudding	1-3	2	185	50
* Sweet and savoury soufflés	1-3	0.75	180	50
* Pizzas and savoury roll	1-3-4	0.5	200	30
Toasted sandwiches	1-3-4	0.5	190	15
Defrosting				
Ready-to-eat dishes	1-3	1	200	45
Meat	1-3	0.5	50	50
Meat	1-3	0.75	50	70
Meat	1-3	1	50	110

Notes:

- 1) Cooking times do not include oven pre-heating, except for those marked with an asterisk
- 2) The indication given in the table for the guide rails is the one that should preferably be used in the event of cooking on more than one level.
- 3) The indicated times refer to cooking on one shelf only; for cooking on more than one level, increase the time by 5 ÷ 10 min.
- 4) For roast beef, veal, pork and turkey, on the bone or rolled, increase the times by 20 min.

INSTALLATION

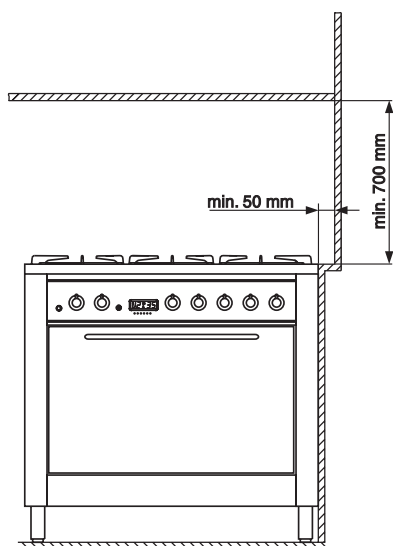

fig.4

The following instructions are provided for qualified installers so that they may accomplish installation, adjustment and technical maintenance operations correctly and in compliance with current regulations and standards.

Important: the appliance should be disconnected from the mains electricity supply before any adjustment, maintenance, etc. is carried out. Maximum caution should be used should it be necessary to keep the appliance connected to the electricity supply.

The cookers have the following technical specifications:

Category: II 2H3+ Class: 1 Type: Y

The dimensions of the appliance are given in the figure on page 2.

For trouble-free operation of appliances installed in housing units, the minimum distances shown in fig.4 should be observed. Adjacent surfaces and the wall at the rear should also be able to withstand an overheating temperature of 65 °C.

Prior to installing the cooker, 95 ÷ 155 mm high supporting feet (provided) should be fitted into the holes to be found in the bottom of the cooker (fig.5). These feet are screw-adjustable and whenever necessary should be used to make sure the cooker stands level.

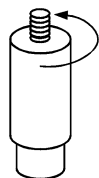
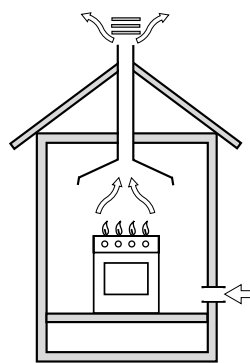

fig.5

Positioning

This appliance may only be installed and operated in permanently ventilated rooms in compliance with current standards. The following requirements must be observed:

- The appliance must discharge combustion products into a special hood, which must be connected to a chimney, flue pipe or directly to the outside (fig.6).
- If it is impossible to fit a hood, the use of an electric fan is permitted, either installed on a window or on an external wall, which must be switched on at the same time as the appliance.



In a chimney stack or branched flue (exclusively for cooking appliances)

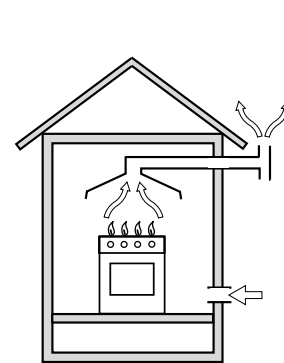

Directly to the outside

Kitchen ventilation

The air flow into the room where the appliance is installed must equal the quantity of air that is required for regular combustion of the gas and for ventilating the same room.

Air must be taken in naturally through permanent apertures made in the outside walls of the room or through single or branching collective ventilation ducts in compliance with current standards and regulations.

The air must be taken directly from the outside, from an area far from sources of pollution.

The ventilation aperture must have the following characteristics (fig.7A):

- total free cross section of passage of at least 6 cm² for every kW of rated heating capacity of the appliance, with a minimum of 100 cm² (the heating capacity is indicated on the rating plate);
- it must be made in such a way that the aperture, both on the inside and outside of the wall, cannot be obstructed;
- it must be protected, e.g. with grates, wire mesh, etc. in such a way that the above-mentioned free section is not reduced;
- it must be situated as near to floor level as possible.

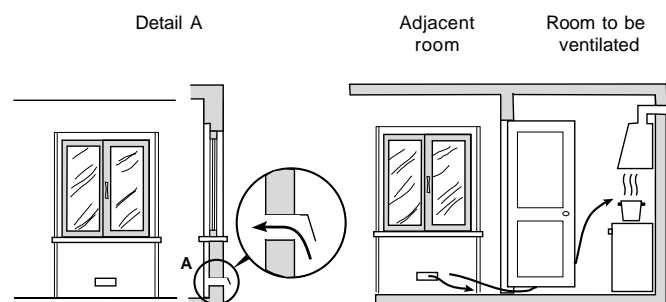

Examples of ventilation holes for comburant air

fig. 7A

Enlarging the ventilation slot between window and floor

fig. 7B

The air inflow may also be obtained from an adjoining room, provided the latter is not a bedroom or a room where there is a risk of fire, such as warehouses, garages, fuel stores, etc. and is ventilated in compliance with the current standards and regulations.

Air from the adjoining room to the one to be ventilated may be made to pass freely through permanent apertures with a cross section at least equal to that indicated above. These apertures may also be obtained by increasing the gap between the door and the floor (fig.7B).

If an electric fan is used for extracting the combustion products, the ventilation aperture must be increased in relation to its maximum performance. The electric fan should have a sufficient capacity to guarantee an hourly exchange of air equal to 3 ÷ 5 times the volume of the kitchen.

Prolonged, intensive use of the appliance may require extra ventilation, e.g. an open window or a more efficient ventilation system by increasing the extraction power of the electric fan if installed.

Liquid petroleum gas descends towards the floor as it is heavier than air. Apertures in the outside walls in rooms containing LPG cylinders should therefore be at floor level, in order to allow any gas from leaks to be expelled. Do not store LPG cylinders (even when empty) in basements or rooms below ground level; it is advisable to keep only the cylinder in use in the room at any one time and connected far from heat sources which could raise its temperature to above 50 °C.

Gas supply connection

- Check that the appliance is set for the type of gas available and then connect it to the mains gas piping or the gas cylinder in compliance with current regulations and standards.
- This appliance is designed and set to work with the gas indicated on the label situated on the actual hob. If the gas supply is other than the type for which the appliance has been set, proceed with replacing the corresponding nozzles (provided), following instructions given in the paragraph "Adaptation to different types of gas".
- For trouble-free operation, suitable use of energy and longer life of the appliance, make sure that the supply pressure complies with the values indicated in the table 1 "burners and nozzles specifications, otherwise install a special pressure regulator on the supply pipe in compliance with current standards and regulations.
- Connect in such a way that the appliance is subjected to no strain whatsoever.

Either a rigid metal pipe with fittings in compliance with the standards in force must be used for connecting to the nipple union (threaded ½"G male fitting) situated at the rear of the appliance to the right (fig.8), or flexible steel pipe in compliance with the standards in force, which must not exceed 2000 mm in length.

Should it be necessary to turn the fitting, the gasket (supplied with the appliance) must be replaced.

Upon completion of installation, check the gas circuit, the internal connections and the taps for leaks using a soapy solution (never a flame).

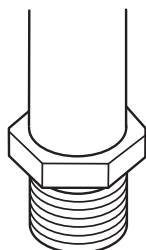

fig.8

Also check that the connecting pipe cannot come into contact with moving parts which could damage or crush it. Make sure that the natural gas pipe is adequate for a sufficient supply to the appliance when all the burners are lit

Important: A pressure regulator, in compliance with the standards in force, must be inserted when connecting to a liquid gas supply (in a cylinder).

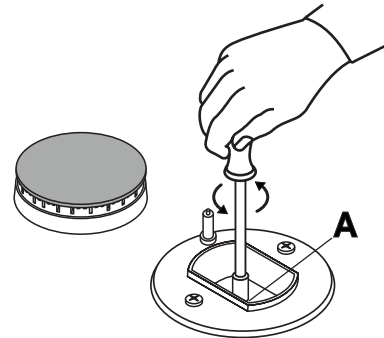

fig.9

Adaptation to a different type of gas

If the appliance is to be converted for use with a type of gas other than that for which it was set in the factory (indicated on the label to be found on the hob), the burner nozzles should be replaced as follows:

- remove the grids and the burners.
- Unscrew the nozzles "A" (fig.9), using a 7 mm socket wrench and replace them, according to the table 1 "burners and nozzles specifications", with ones suitable for the new type of gas.
- On completing the operation, replace the old rating label with the one showing the new type of gas; the sticker is available from our Service Centres.
- Re-assemble all the components.

Adjusting the low flame

- Put the tap to the low flame position (the burner should be lit);
- Remove the tap knob and turn the adjusting screw, situated to the side of the tap stem (fig.10) until you obtain a regular small flame, using a screwdriver (loosening the screw increases the height of the flame, tightening decreases it).
N.B. : the adjusting screw must be fully screwed down for liquid gas.
- Having obtained the low flame setting required and with the burner lit, abruptly change the position of the knob several times from minimum to maximum and vice versa and check that the flame does not go out.
- Refit the tap knobs

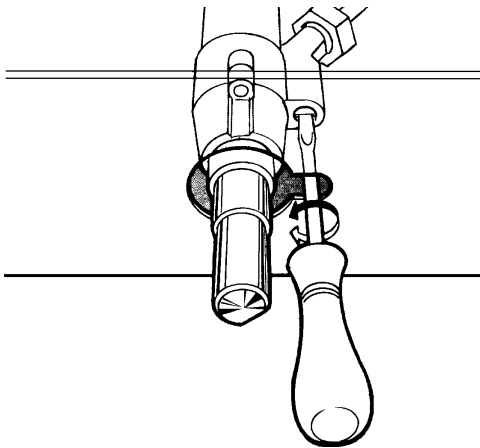

fig.10

ELECTRICAL CONNECTION

THE APPLIANCE MUST BE EARTHED

The appliance is designed to work with alternating current at the supply voltage and frequency indicated on the rating plate (situated on the rear part of the appliance and on the last page of the instruction booklet). Make sure that the local supply voltage corresponds to the voltage indicated on the rating plate.

Connecting the supply cable to the mains electricity supply

For models supplied without a plug, fit a standard plug, suitable for the load indicated on the rating plate, onto the cable and connect it to a suitable socket.

To connect directly to the mains supply, an omnipolar switch with a contact break of at least 3 mm suitable for the load and complying with current standards and regulations must be fitted between the appliance and the mains supply outlet. The yellow-green earth wire must not be interrupted by the switch.

The supply cable must be in such a position that no part of it can reach a temperature of 50 °C above room temperature. All the appliances should be connected separately.

Do not use adapters or shunts as they could cause heating or burning.

Before connecting to the power supply, make sure that:

- the limiter valve and the domestic system can withstand the load from the appliance (**see rating plate**);
- the supply system is efficiently earthed according to the standards and laws in force;
- the socket or omnipolar switch are easily accessible when the appliance is installed.

FAILURE TO OBSERVE THE ACCIDENT-PREVENTION REGULATIONS RELIEVES THE MANUFACTURER OF ALL LIABILITY.

Replacing the cable

Use a rubber cable of the type H05VV-F with a suitable cross section of 3 x 1.5 mm².

The yellow-green earth wire must be 2 ÷ 3 cm longer than the other wires.

BURNER AND NOZZLE SPECIFICATIONS

Table 1

Burner	Diameter (mm)	Thermal power kW (H.s.*)		Liquid gas				Natural gas	
		Nomin.	Reduc.	By-pass 1/100 (mm)	Nozzle 1/100 (mm)	Flow * g/h		Nozzle 1/100 (mm)	Flow* l/h
						G30	G37		
Rapid C	100	3.00	0.7	40	86	218	214	116	286
Semi-rapid B	75	1.65	0.4	30	64	120	118	96	157
Auxiliary A	55	1.00	0.3	27	50	73	71	71	95
Triple ring D	130	3.25	1.3	57	91	236	232	124	309
Supply pressure						30	37		20



* At 15°C and 1013 mbar-dry gas
 Propane G31 H.s. = 50,37 MJ/kg
 Butane G30 H.s. = 49,47 MJ/kg
 Methane G20 H.s. = 37,78 MJ/m³

TROUBLESHOOTING

Sometimes, the appliance could not function properly or at all. Before calling customer services for assistance, let's see what can be done.

First of all, check to see that there are no interruptions in the gas and electrical supplies, and, in particular, that the gas valves for the mains are open.

The burner does not light or the flame is not uniform around the burner.

Check to make sure that:

- The gas holes on the burner are not clogged.
- All the movable parts that make up the burner are mounted correctly.
- There are no draughts around the appliance.

The flame does not stay lit.

Check to make sure that:

- You press the knob all the way in.
- You keep the knob pressed in long enough to activate the safety device.
- The gas holes are not clogged in the area corresponding to the safety device.

The burner does not remain on when set to "Low".

Check to make sure that:

- The gas holes are not clogged.
- There are no draughts near the appliance.
- The minimum flame has been adjusted correctly (see the section entitled, "Adjusting the low flame").

The cookware is not stable.

Check to make sure that:

- The bottom of the cookware is perfectly flat.
- The cookware is centered correctly on the burner.

If, despite all these checks, the hob does not function properly and the problem persists, call the nearest Merloni Elettrodomestici Customer Service Centre, informing them of the following information:

- The type of problem.
- The abbreviation used to identify the model (Mod. ...) as indicated on the warranty.

Never call upon technicians not authorized by the manufacturer, and always refuse to accept spare parts that are not original.

Merloni Elettrodomestici

Viale Aristide Merloni 47

60044 Fabriano

Italy

Tel +39 0732 6611

Fax +39 0732 662501

www.merloni.com

Cucina Maxiforno " KP 59 MS (X) /G"
02/01 - 195030285.00 Xerox Business Services - Docutech

Free Manuals Download Website

<http://myh66.com>

<http://usermanuals.us>

<http://www.somanuals.com>

<http://www.4manuals.cc>

<http://www.manual-lib.com>

<http://www.404manual.com>

<http://www.luxmanual.com>

<http://aubethermostatmanual.com>

Golf course search by state

<http://golfingnear.com>

Email search by domain

<http://emailbydomain.com>

Auto manuals search

<http://auto.somanuals.com>

TV manuals search

<http://tv.somanuals.com>