

Multifunction oven

Instructions for installation and use

FM 10 RK.C GB
FM 20 K.C IX GB



GB Multifunction Oven
Instructions for installation and use

Congratulations on choosing an Indesit appliance, which you will find is dependable and easy to use. We recommend that you read the instructions in this owner's manual carefully before use for the best performance and to extend the life of your appliance, as it will provide you with all the instructions you require to ensure its safe installation, use and maintenance. Always keep this owner's manual close to hand since you may need to refer to it in the future. Thank you.

Close-up view

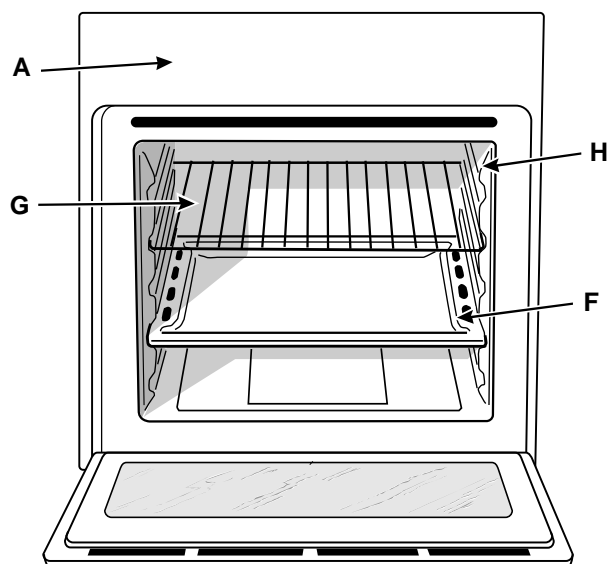
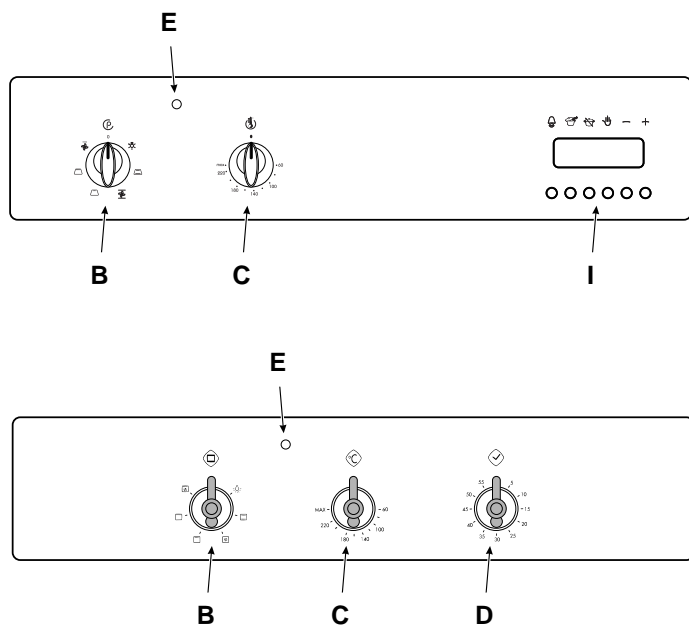

- A. **Control Panel**
- B. **Cooking mode selection knob**
- C. **Cooking temperature selection knob**
- D. **Timer knob** (only available on certain models)
- E. **Oven indicator light** (only available on certain models)
- When lit, it indicates the ovens is heating up to the temperature set.
- F. **Dripping Pan or Baking Sheet**
- G. **Oven Rack**
- H. **Guides for sliding the racks or dripping pan in and out**
- I. **Electronic programmer** (only available on certain models) - Allows you to programme the desired cooking mode by selecting the cooking time and the end cooking time. It can also be used as a timer.

How to use your oven

This multi-function oven combines the advantages of traditional convection ovens with those of the more modern fan assisted models in a single appliance.

It is an extremely versatile appliance that allows you to choose easily and safely between 5 different cooking modes. The various features offered by the oven are selected by means of selector knob "B" and thermostat "C" situated on the control panel.

Notice: The first time you use your appliance, we recommend that you set the thermostat to the highest setting and leave the oven on for about half an hour with nothing in it, with the oven door shut. Then, open the oven door and let the room air. The odour that is often detected during this initial use is due to the evaporation of substances used to protect the oven during storage and until it is installed.

Notice: Place the dripping pan provided on the bottom shelf of the oven to prevent any sauce and/or grease from dripping onto the bottom of the oven only when grilling food or when using the rotisserie (only available on certain models). For all other types of cooking, never use the bottom shelf and never place anything on the bottom of the oven when it is in operation because this could damage the enamel. Always place your cookware (dishes, aluminium foil, etc. etc.) on the grid provided with the appliance inserted especially along the oven guides

Convection Mode /

Position of thermostat knob "C": between **60°C** and **Max**. On this setting, the top and bottom heating elements come on. This is the classic, traditional type of oven which has been perfected, with exceptional heat distribution and reduced energy consumption. The convection oven is still unequalled when it comes to cooking dishes made up of several ingredients, e.g. cabbage with ribs, Spanish style cod, Ancona style stockfish, tender veal strips with rice, etc. Excellent results are achieved when preparing veal or beef-based dishes as well (braised meats, stew, goulash, wild game, ham etc.) which need to cook slowly and require basting or the addition of liquid. It nonetheless remains the best system for baking cakes as well as fruit and cooking using covered casserole dishes for oven baking. When cooking in convection mode, only use one dripping pan or cooking rack at a time, otherwise the heat distribution will be uneven. Using the different rack heights available, you can balance the amount of heat between the top and the bottom of the oven. Select from among the various rack heights based on whether the dish needs more or less heat from the top.

Fan Assisted Mode /

Position of thermostat knob "C": Between **60°C** and **Max**. The heating elements, as well as the fan, will come on. Since the heat remains constant and uniform throughout the oven, the air cooks and browns food uniformly over its entire surface. With this mode, you can also cook various dishes at the same time, as long as their respective cooking temperatures are the same. A maximum of 2 racks can be used at the same time, following the instructions in

the section entitled: "Cooking On More Than One Rack". This fan assisted mode is particularly recommended for dishes requiring a gratin finish or for those requiring considerably prolonged cooking times, such as for example: lasagne, pasta bakes, roast chicken and potatoes, etc... Moreover, the excellent heat distribution makes it possible to use lower temperatures when cooking roasts. This results in less loss of juices, meat which is more tender and a decrease in the loss of weight for the roast. The fan assisted mode is especially suited for cooking fish, which can be prepared with the addition of a limited amount of condiments, thus maintaining their flavour and appearance.

Desserts: the fan assisted mode is also perfect for baking leavened cakes.

Moreover, this mode can also be used to thaw quickly white or red meat and bread by setting the temperature to 80 °C. To thaw more delicate foods, set the thermostat to 60°C or use only the cold air circulation feature by setting the thermostat to 0°C.

"Top" oven /

Position of thermostat knob "C": Between **60°C** and **Max**. The top heating element comes on.

This mode can be used to brown food at the end of cooking.

Grill /

Position of thermostat knob "C": **Max**

The top central heating element comes on.

The extremely high and direct temperature of the grill makes it possible to brown the surface of meats and roasts while locking in the juices to keep them tender. The grill is also highly recommended for dishes that require a high temperature on the surface: beef steaks, veal, rib steak, filets, hamburgers etc...



Some grilling examples are included in the "Practical Cooking Advice" paragraph.

Fan Assisted Grill /

Position of thermostat knob "C": between **60°C** and **200°C**. The top central heating element and the fan come on. This combination of features increases the effectiveness of the unidirectional thermal radiation of the heating elements through forced circulation of the air throughout the oven. This helps prevent food from burning on the surface, allowing the heat to penetrate right into the food. Excellent results are achieved with kebabs made with meats and vegetables, sausages, ribs, lamb chops, chicken in a spicy sauce, quail, pork chops, etc.

This mode is also ideal for cooking fish steaks, like swordfish, tuna, grouper, stuffed cuttlefish etc.

Timer (D) (only available on certain models)

To use the timer, the buzzer "D" must be wound up by turning the knob one full turn clockwise ; then turn it back  to the desired time so that the number of minutes on the knob matches the reference mark on the panel.

The oven light

Set knob "B" to the  symbol to turn it on. It lights the oven and stays on when any of the electrical heating elements in the oven come on.

Cooling ventilation

In order to cool down the exterior of the appliance, some models are equipped with a cooling fan which comes on automatically when the oven is hot.

When the fan is on, a normal flow of air can be heard exiting between the oven door and the control panel.

Note: When cooking is done, the fan stays on until the oven cools down sufficiently.

How to Keep Your Oven in Shape

Before cleaning your oven, or performing maintenance, disconnect it from the power supply.

To extend the life of your oven, it must be cleaned frequently, keeping in mind that:

- **Do not use steam equipment to clean the appliance.**
- the enamelled or stainless steel parts should be washed with lukewarm water without using any abrasive powders or corrosive substances which could ruin them; Stainless steel could get stained. If these stains are difficult to remove, use special products available on the market. After cleaning, it is advisable to rinse thoroughly and dry.
- the inside of the oven should preferably be cleaned immediately after use, when it is still warm, with hot water and soap; the soap should be rinsed away and the interior dried thoroughly. Avoid using abrasive detergents (for example cleaning powders, etc...) and abrasive sponges for dishes or acids (such as limescale-remover, etc...) as these could damage the enamel. If the grease spots and dirt are particularly tough to remove, use a special product for oven cleaning, following the instructions provided on the packet.
- if you use your oven for an extended period of time, condensation may form. Dry it using a soft cloth.
- there is a rubber seal surrounding the oven opening which guarantees its perfect functioning. Check the condition of this seal on a regular basis. If necessary, clean it and avoid using abrasive products or objects to do so. Should it become damaged, please contact your nearest After-sales Service Centre. We recommend you avoid using the oven until it has been repaired.
- never line the oven bottom with aluminium foil, as the consequent accumulation of heat could compromise the cooking and even damage the enamel.
- clean the glass door using non-abrasive products or sponges and dry it with a soft cloth.

How to remove the oven door

For a more thorough clean, you can remove the oven door. Proceed as follows:

- open the door fully;
- lift up and turn the small levers situated on the two hinges;
- grip the door on the two external sides, shut it slowly but not completely;
- pull the door towards you, pulling it out of its seat;

Reassemble the door by following the above procedures backwards.

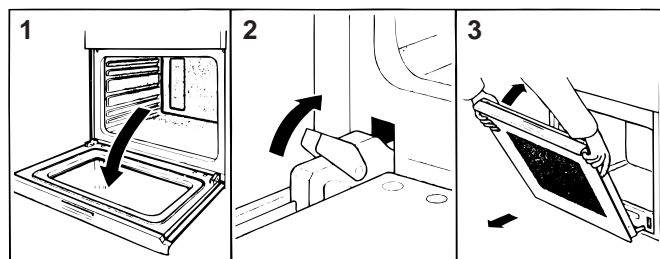

Replacing the Oven Lamp

- Disconnect the oven from the power supply by means of the omnipolar switch used to connect the appliance to the electrical mains; or unplug the appliance if the plug is accessible;
- Remove the glass cover of the lamp-holder;
- Remove the lamp and replace with a lamp resistant to high temperatures (300°C) with the following characteristics:
 - Voltage: 230/240 V
 - Wattage 25W
 - Type E14
- Replace the glass cover and reconnect the oven to the mains power supply.

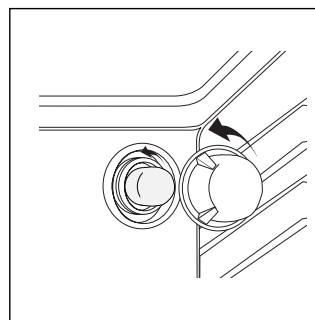

Electronic Cooking Programmer

The programmer makes it possible to preset the oven and the grill in terms of:

- delay start with a preset length of time for cooking;
- immediate start with a preset length of time for cooking;
- timer.

Button functions:

 : Timer with hour and minutes;

 : Length of cooking time;

 : End cooking time;





 : Manual change;

 : Change time (backwards);

 : Change time (forwards).

How to Reset the Digital Clock



After the appliance has been connected to the power source or following a power outage, the clock display will begin to blink and read: **0:00**

- Press the  and  buttons at the same time. Then use (within 4 seconds) the  and  buttons to set the exact time.

Use the  button to move the time forwards.

Use the  button to move the time backwards.

The time can also be changed in the following two ways:

1. Repeat all of the foregoing steps.
2. Press the  button, and then use the  and  buttons to reset the time.



Manual Operation Mode for the Oven

After the time has been set, the programmer is automatically set to manual mode.

Note: Press the  button to return the oven to manual mode after every "Automatic" cooking session.



Delayed Start Time with Preset Cooking Length

The length and the end cooking times must be set. Let us suppose that the display shows 10:00.

1. Turn the oven control knob to the cooking setting and temperature desired (example: convection oven at 200°C).
2. Press the  and use (within 4 seconds) the  and  buttons to set the length of the cooking time. Let us suppose that 30 minutes was set for the length of the cooking time. In this case, the display will show:

 0:30



Release the button, and within 4 seconds, the current time will reappear with the  symbol and "auto."



3. Press the  button, and then use the  and  buttons to set the end cooking time. Let us suppose that it is 13:00

 13:00

4. Release the button and the display will show the current time within 4 seconds:

 10:00



When "auto" is lighted, it indicates that the length and end cooking time have been preset to operate in automatic mode. At this point, the oven will turn on automatically at 12:30 in order to finish the cooking session within 30 minutes. When the oven is on, the  symbol (cooking pot) will appear on the display for the entire length of the cooking process. The  button can be pressed at any time to display the setting for the length of the cooking time, while the  button can be pressed to display the end cooking time.

At the end of the cooking time, an acoustic signal will sound. Press any button it turn it off (except the  and  buttons).

Immediate Start Time with Preset Cooking Length

When only the length of the cooking time is set (points 1 and 2 of the paragraph entitled, "Delayed Start Time with Preset Cooking Length"), the cooking session starts immediately.

Cancelling a Preset Cooking Time

Press the  button, and use the  button to set the time to:

0:00

Then press the manual cooking mode button .

Timer Feature

The timer can be used to count down from a given length of time. This feature does not control when the oven comes on or turns off, but, rather, it only emits an acoustic signal when the preset time has run out.



Press the  button, and the display will read:

0:00



Then use the  and  buttons to set the desired time.

Release the button, and the timer will start at that second. The display will show the current time.

10:00

At the end of the preset time, an acoustic signal will sound, which can be turned off by pressing any button (except the  and  buttons), and the  symbol will turn off.



Changing and Cancelling Settings

- The settings can be changed at any time by pressing the corresponding button and using the  or  button.
- When the length setting for the cooking time is cancelled, the end cooking time setting is also cancelled, and vice versa.
- When in automatic cooking mode, the appliance will not accept end cooking times prior to the start cooking time proposed by the appliance itself.



Practical Cooking Advice

The oven offers a wide range of alternatives which allow you to cook any type of food in the best possible way. With time you will learn to make the best use of this versatile cooking appliance and the following directions are only a guideline which may be varied according to your own personal experience.

Preheating

If the oven must be preheated (this is generally the case when cooking leavened foods), the "fan assisted" mode  /  can be used to reach the desired temperature as quickly as possible in order to save on energy. Once the food has been placed in the oven, the most appropriate cooking mode can then be selected.



Cooking on More Than One Rack

If you have to cook on more than one rack at the same time, use only the "fan assisted mode"  /  which is the only one that is appropriate for this type of cooking.



- The oven is fitted with 5 racks. During fan assisted cooking, use two of the three central racks; the lowest and highest racks receive the hot air directly and therefore delicate foodstuffs could be burnt on these racks.
- As a general rule, use the 2nd and 4th rack from the bottom, placing the foodstuffs that require greater heat on the 2nd rack from the bottom. For example, when cooking meat roasts together with other food, place the roast on the 2nd rack from the bottom and the more delicate food on the 4th rack from the bottom.
- When cooking foodstuffs that require differing times and temperatures, set a temperature that is somewhere between the two temperatures required, place the more delicate food on the 4th rack from the bottom and take the food requiring less time out of the oven first.
- Use the dripping pan on the lower rack and the grid on the upper;

Using the Grill

This multi-function oven offers you **2 different grilling modes only and exclusively with the oven door shut.**

Use the "grill" mode  / , placing the food under the centre of the grill (situated on the 3rd or 4th rack from the bottom) because only the central part of the top heating element is turned on.

Use the bottom rack (1st from the bottom), placing the dripping pan provided to collect any sauce and/or grease and prevent the same from dripping onto the oven bottom. When using this mode, we recommend you set the thermostat to the highest setting. However, this does not mean you cannot use lower temperatures, simply by adjusting the thermostat knob to the desired temperature.

Setting  / , "fan assisted grill", is extremely useful for grilling foods rapidly, as the distribution of heat makes it possible not only to brown the surface, but also to cook the bottom part.

Moreover, it can also be used for browning foods at the end of the cooking process, such as adding that gratin finish to pasta bakes, for example.

When using this mode, place the grid on the 2nd or 3rd oven rack from the bottom (see cooking table) then, to prevent fat and grease from dripping onto the bottom of the oven and thus smoke from forming, place a dripping-pan on the 1st rack from the bottom.

Important: always use the grill with the oven door shut.

This will allow you both to obtain excellent results and to save on energy (approximately 10%).

When using this mode, we advise you to set the thermostat to 200°C, as it is the most efficient way to use the grill, which is based on the use of infrared rays. However, this does not mean you cannot use lower temperatures, simply by adjusting the thermostat knob to the desired temperature.

Therefore the best results when using the grill modes are obtained by placing the grid on the lower racks (see cooking table) then, to prevent fat and grease from dripping onto the bottom of the oven and smoke from forming, place a dripping-pan on the 1st oven rack from the bottom.

Baking Cakes

When baking cakes, always place them in a preheated oven. Make sure you wait until the oven has been preheated thoroughly (the red light "E" will turn off). Do not open the oven door during baking to prevent the cake from dropping. In general:

Pastry is too dry

Increase the temperature by 10°C and reduce the cooking time.

Pastry dropped

Use less liquid or lower the temperature by 10°C.

Pastry is too dark on top

Place it on a lower rack, lower the temperature, and increase the cooking time.

Cooked well on the inside but sticky on the outside

Use less liquid, lower the temperature, and increase the cooking time.



The pastry sticks to the pan

Grease the pan well and sprinkle it with a dusting of flour or use greaseproof paper.

I used more than one level (in the function "ventilated oven") and they are not all at the same cooking point

Use a lower temperature setting. It is not necessary to remove the food from all the racks at the same time.

Cooking Pizza

For best results when cooking pizza, use the “**fan assisted**”  /  mode:

- Preheat the oven for at least 10 minutes;
- Use a light aluminium pizza pan, placing it on the grid supplied with the oven. If the dripping pan is used, this will extend the cooking time, making it difficult to get a crispy crust;
- Do not open the oven door frequently while the pizza is cooking;
- If the pizza has a lot of toppings (three or four), we recommend you add the mozzarella cheese on top halfway through the cooking process.
- When cooking pizza on two racks, use the 2nd and 4th with a temperature of 220°C and place the pizzas in the oven after having preheated it for at least 10 minutes.





Cooking Fish and Meat

When cooking white meat, fowl and fish, use temperature settings from 180 °C to 200 °C.

For red meat that should be well done on the outside while tender and juicy in the inside, it is a good idea to start with a high temperature setting (200°C-220°C) for a short time, then turn the oven down afterwards.

In general, the larger the roast, the lower the temperature setting. Place the meat on the centre of the grid and place the dripping pan beneath it to catch the fat.

Make sure that the grid is inserted so that it is in the centre of the oven. If you would like to increase the amount of heat from below, use the low rack heights. For savoury roasts (especially duck and wild game), dress the meat with lard or bacon on the top.

Selector knob setting	Food to be cooked	Weight (in kg)	Cooking rack position from bottom	Preheating time (minutes)	Thermostat knob setting	Cooking time (minutes)
1 Convection 	Duck	1	3	15	200	65-75
	Roast veal or beef	1	3	15	200	70-75
	Pork roast	1	3	15	200	70-80
	Biscuits (short pastry)	-	3	15	180	15-20
	Tarts	1	3	15	180	30-35
2 Fan assisted 	Pizza (on 2 racks)	1	2-4	15	220	15-20
	Lasagne	1	3	10	200	30-35
	Lamb	1	2	10	180	50-60
	Roast chicken + potatoes	1	2-4	10	180	60-75
	Mackerel	1	2	10	180	30-35
	Plum-cake	1	2	10	170	40-50
	Cream puffs (on 2 racks)	0.5	2-4	10	190	20-25
	Biscuits (on 2 racks)	0.5	2-4	10	180	10-15
	Sponge cake (on 1 rack)	0.5	2	10	170	15-20
	Sponge cake (on 2 racks)	1.0	2-4	10	170	20-25
	Savoury pies	1.5	3	15	200	25-30
	3 Top Oven 	Browning food to perfect cooking	-	3/4	15	220
4 Grill 	Soles and cuttlefish	1	4	5	Max	8-10
	Squid and prawn kebabs	1	4	5	Max	6-8
	Cod filet	1	4	5	Max	10
	Grilled vegetables	1	3/4	5	Max	10-15
	Veal steak	1	4	5	Max	15-20
	Cutlets	1	4	5	Max	15-20
	Hamburgers	1	4	5	Max	7-10
	Mackerels	1	4	5	Max	15-20
	Toasted sandwiches	n.° 4	4	5	Max	2-3
5 Fan assisted grill 	Grilled chicken	1.5	3	5	200	55-60
	Cuttlefish	1.5	3	5	200	30-35

NB: cooking times are approximate and may vary according to personal taste. When cooking using the grill or fan assisted grill, the dripping pan must always be placed on the 1st oven rack from the bottom.

Safety Is A Good Habit To Get Into

To maintain the efficiency and safety of this appliance, we recommend that you do the following:

- only call the Service Centres authorised by the manufacturer
- always use original spare parts

- **When handling the appliance, we recommend you always use the purpose provided handles recessed into the sides of the oven to prevent harming people or damaging the appliance itself.**
- This appliance is designed for non-professional, household use and its functions must not be changed.
- These instructions are only valid for the countries whose symbols appear on the manual and the serial number plate.
- The electrical system of this appliance can only be used safely when it is correctly connected to an efficient earthing system in compliance with current safety standards.
- **When the appliance is in use, the heating elements and some parts of the oven door become extremely hot. Make sure you don't touch them and keep children well away.**

The following items are potentially dangerous, and therefore appropriate measures must be taken to prevent children and the disabled from coming into contact with them:

- Controls and the appliance in general;
- Packaging (bags, polystyrene, nails, etc.);
- The appliance itself, immediately after use of the oven or grill due to the heat generated;
- The appliance itself, when no longer in use (potentially dangerous parts must be made safe).

Avoid the following:

- Touching the appliance with wet parts of the body;
- Using the appliance when barefoot;
- Pulling on the appliance or the supply cable to unplug it from the electrical outlet;
- Improper or dangerous operations;
- Obstructing the ventilation or heat dissipation slots;
- Allowing power supply cables of small appliances to come into contact with the hot parts of the appliance;
- Exposing the appliance to atmospheric agents such as rain, or sunlight;
- Using the oven for storage purposes;
- Using flammable liquids near the appliance;

- Using adapters, multiple sockets and/or extension leads;
- Attempting to install or repair the appliance without the assistance of qualified personnel.

Qualified personnel must be contacted in the following cases:

- Installation (following the manufacturer's instructions);
- When in doubt about operating the appliance;
- Replacing the electrical socket when it is not compatible with the appliance plug.

Service Centres authorised by the manufacturer must be contacted in the following cases:

- If in doubt about the soundness of the appliance after removing it from its packaging;
- If the power supply cable has been damaged or needs to be replaced;
- If the appliance breaks down or functions poorly; ask for original spare parts.

It is a good idea to do the following:

- Only use the appliance to cook food and nothing else;
- Check the soundness of the appliance after it has been unpacked;
- Disconnect the appliance from the electrical mains if it is not functioning properly and before cleaning or performing maintenance;
- When left unused, unplug the appliance from the electricity mains and turn off the gas tap (if foreseen);
- Use oven gloves to place cookware in the oven or when removing it;
- Always grip the oven door handle in the centre as the extremities of the same may be hot due to any hot air leaks;
- Make sure the knobs are in the "•"/"o" position when the appliance is not in use.
- Cut the power supply cable after disconnecting it from the mains when you decide not to use the appliance any longer.
- The manufacturer may not be held responsible for any damage due to: incorrect installation, improper, incorrect and irrational use.

Installation

The appliance must be installed only by a qualified person in compliance with the instructions provided. The manufacturer declines all responsibility for improper installation which may harm persons and animals and damage property.

Blocco Vuoto

Installation of Built-in Ovens

In order to ensure that the built-in appliance functions properly, the cabinet containing it must be appropriate. The figure below gives the dimensions of the cut-out for installation under the counter or in a wall cabinet unit.

In order to ensure adequate ventilation, the back panel of the cabinet unit must be removed. Installing the oven so

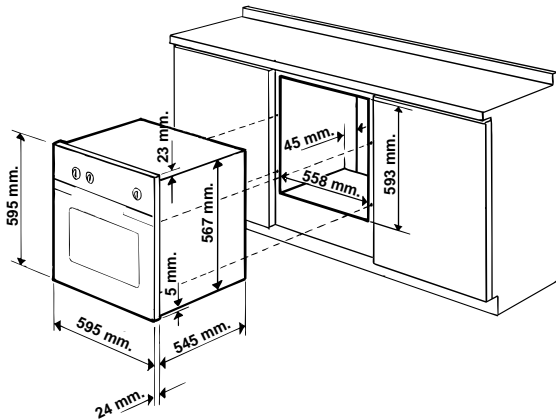

N.B.: Installation in compliance with the consumption declaration

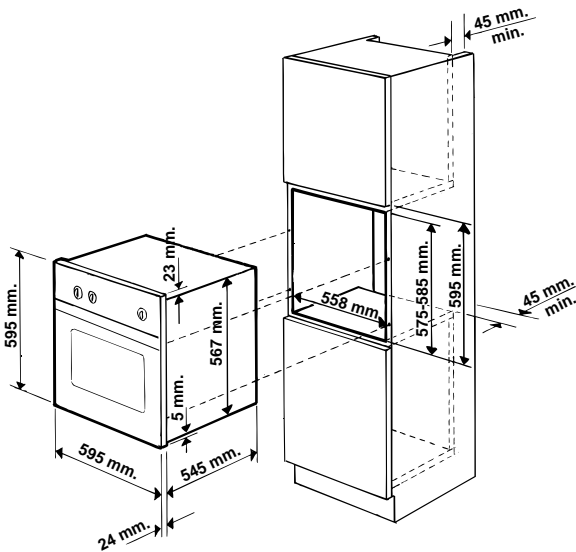

that it rests on two strips of wood is preferable. If the oven rests on a continuous, flat surface, there must be an aperture of at least 45 x 560 mm.

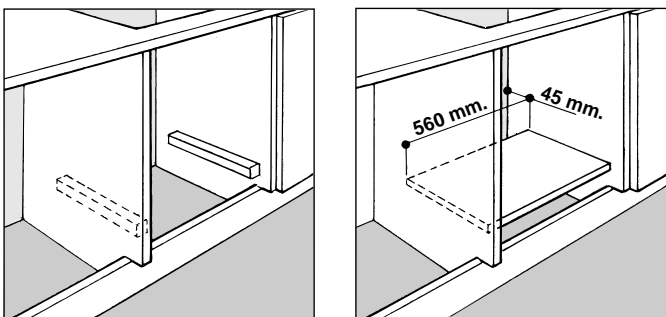

The panels of the adjacent cabinets must be made of heat-resistant material. In particular, cabinets with a veneer exterior must be assembled with glues which can withstand temperatures of up to 100 °C.

In compliance with current safety standards, contact with the electrical parts of the oven must not be possible once it has been installed.

All parts which ensure the safe operation of the appliance must be removable only with the aid of a tool.

To fasten the oven to the cabinet, open the door of the oven and attach it by inserting the 4 wooden screws into the 4 holes located on the perimeter of the frame.

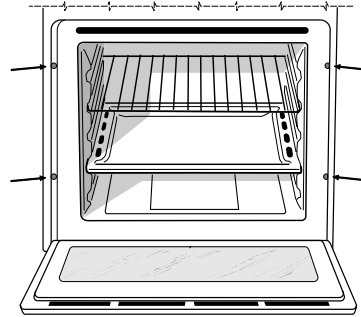

Electrical connection

Ovens with a three-pole power supply cable are designed to operate with alternated current at the supply frequency and voltage indicated on the data plate (at the bottom of the oven dashboard). The earthing conductor of the cable is the yellow-green conductor.

Two types of connection are provided:

Connection n° 1

Connecting the power supply cable to the mains.

Fit a normalized plug to the cable, which corresponds to the load indicated on the data plate; if the cooker is connected directly to the mains, an omnipolar circuit-breaker with a minimum opening of 3 mm between the contacts, suitable for the load indicated and complying with current directives, must be installed between the appliance and the mains (the earthing wire must not be interrupted by the circuit-breaker). The power supply cable must be positioned so that it does not exceed room temperature by 50°C at any point of its length. Before making the connection check that:

- the circuit breakers or fuses of the home system can support appliance load (see data plate);
- the power supply system has an efficient earthing connection which complies with the provisions of current regulations and the law;
- there is easy access to the socket or the omnipolar circuit-breaker once the cooker has been installed.

N.B.: do not use reducers, adapters or shunts as these could cause heating or burning.

Connection n° 2

Disposing of the plug.

WARNING: THIS APPLIANCE MUST BE EARTHED.

Ensure that before disposing of the plug itself, you make the pins unusable so that it cannot be accidentally inserted into a socket. Instructions for connecting cable to an alternative plug:

Important: the wires in the mains lead are coloured in accordance with the following code:

Green & Yellow	-Earth
Blue	-Neutral
Brown	-Live

If the colours of the wires in the mains lead do not correspond with the coloured markings identifying the terminals in your plug, proceed as follows.

Connect Green & Yellow wire to terminal marked "E" or  or coloured Green or Green & Yellow.

Connect Brown wire to terminal marked "L" or coloured Red. Connect Blue wire to terminal marked "N" or coloured Black. If a 13 amp plug (BS 1363) is used it must be fitted with a 13 amp fuse.

A 15 amp plug must be protected by a 15 amp fuse, either in the plug or adaptor or at the distribution board. If you are in any doubt about the electrical supply to your machine, consult a qualified electrician before use.

How to connect an alternative plug

The wires in this mains lead are coloured in accordance with the following code:

BLUE	"NEUTRAL" (N)
BROWN	"LIVE" (L)
GREEN AND YELLOW	"EARTH" (E)

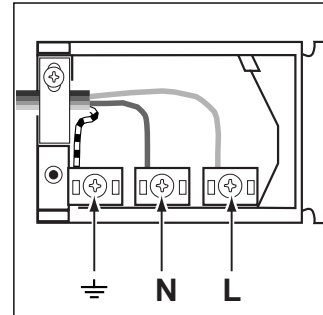

Disposing of the appliance

When disposing of the appliance please remove the plug by cutting the mains cable as close as possible to the plug body and dispose of it as described above.

The plug and socket must be easily accessible.

Technical Specifications

Inner dimensions of the oven:

Width 43.5 cm
Depth 43.5 cm
Height 32 cm

Inner Volume of the Oven:

60 litres

ENERGY LABEL

Directive 2002/40/EC on the label of electric ovens
Norm EN 50304

Models with cooling ventilation:

Energy consumption for Natural convection

heating mode:  Convection

Declared energy consumption for Forced convection Class

heating mode:  Fan assisted

Models without cooling ventilation:

Energy consumption for Forced convection

heating mode:  Fan assisted

Declared energy consumption for Natural convection Class

heating mode:  Convection

Voltage and Frequency of Power Supply:

230V ~ 50/60Hz 2250W



This appliance conforms with the following European Economic Community directives:

- 73/23/EEC of 19/02/73 (Low Voltage) and subsequent modifications;
- 89/336/EEC of 03/05/89 (Electromagnetic Compatibility) and subsequent modifications;
- 93/68/EEC of 22/07/93 and subsequent modifications.





Merloni Elettrodomestici

Viale Aristide Merloni 47

60044 Fabriano

Italy

Tel +39 0732 6611

Fax +39 0732 662501

www.merloni.com

Nuovo Forno da incasso "Multifunzione"
01/03 - 195036791.00 Xerox Business Services - Docutech

Free Manuals Download Website

<http://myh66.com>

<http://usermanuals.us>

<http://www.somanuals.com>

<http://www.4manuals.cc>

<http://www.manual-lib.com>

<http://www.404manual.com>

<http://www.luxmanual.com>

<http://aubethermostatmanual.com>

Golf course search by state

<http://golfingnear.com>

Email search by domain

<http://emailbydomain.com>

Auto manuals search

<http://auto.somanuals.com>

TV manuals search

<http://tv.somanuals.com>