

GB

English, 1

WIDE 127

GB

Contents

Installation, 2-3-4-5

Unpacking and levelling, 2
Electric and water connections, 2-3
The first wash cycle, 4
Technical details, 5

Washer-dryer description, 6-7

Control panel, 6
Display, 7
“MEMO” Programme, 7

Starting and Programmes, 8

Briefly: how to start a programme, 8
Programme table, 8

Personalisations, 9-10

Setting the spin cycle, 9
Setting the delay timer, 9
Setting the temperature, 9
Setting the drying cycle, 9
Functions, 10

Detergents and laundry, 11

Detergent dispenser, 11
Preparing your laundry, 11
Special items, 11
Woolmark, 11

Precautions and advice, 12

General safety, 12
Disposal, 12
Saving energy and respecting the environment, 12

Care and maintenance, 13

Cutting off the water or electricity supply, 13
Cleaning your appliance, 13
Cleaning the detergent dispenser, 13
Caring for your appliance door and drum, 13
Cleaning the pump, 13
Checking the water inlet hose, 13

Troubleshooting, 14

Service, 15

Before calling for Assistance, 15

Installation

GB

! Keep this instruction manual in a safe place for future reference. Should the appliance be sold, transferred or moved, make sure the instruction manual accompanies the washer-dryer to inform the new owner as to its operation and features.

! Read these instructions carefully: they contain vital information on installation, use and safety.

Unpacking and levelling

Unpacking

1. Unpack the washer-dryer.
2. Check whether the washer-dryer has been damaged during transport. If this is the case, do not install it and contact your retailer.

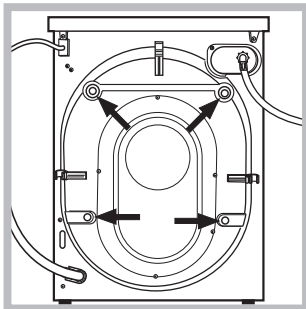

3. Remove the four protective screws and the rubber bush with the respective spacer, situated on the rear of the appliance (see also the installation leaflet). **NB:** The plastic spacers may fall down inside the machine once the bolt

has been removed, and will not interfere with the operation of the machine.

4. Seal the gaps using the plastic plugs provided.
5. Keep all the parts: you will need them again if the washing machine needs to be moved to another location.

! Packaging materials are not children's toys.

Levelling

Your machine may make a considerable amount of noise if the two front feet have not been adjusted correctly.

1. Install the washer-dryer on a flat sturdy floor, without resting it up against walls, furniture cabinets or other.

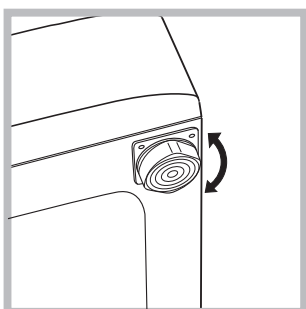

2. If the floor is not perfectly level, compensate for any unevenness by tightening or loosening the adjustable front feet (see figure); the angle of inclination, measured according to the worktop, must not exceed 2°.

Levelling your appliance correctly will provide it with stability and avoid any vibrations, noise and shifting during operation. If it is placed on a fitted or loose carpet, adjust the feet in such a way as to allow enough room for ventilation beneath the washer-dryer.

Electric and water connections

Connecting the water inlet hose

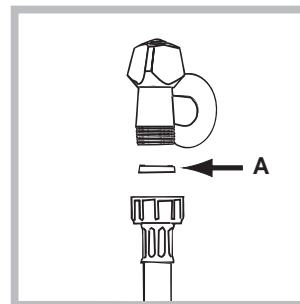

1. Insert seal A into the end of the inlet hose and screw the latter onto a cold water tap with a 3/4 gas threaded mouth (see figure). Before making the connection, allow the water to run freely until it is perfectly clear.

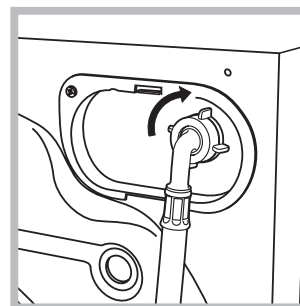

2. Connect the other end of the water inlet hose to the washer-dryer, screwing it onto the appliance's cold water inlet, situated on the top right-hand side on the rear of the appliance (see figure).

3. Make sure there are no kinks or bends in the hose.

! The water pressure at the tap must be within the values indicated in the Technical details table (on the next page).

! If the water inlet hose is not long enough, contact a specialist store or an authorised serviceman.

! Ensure that the supply taps are allowing water through. Old taps may seize in the closed position and thus prevent water reaching the machine.

Connecting the drain hose

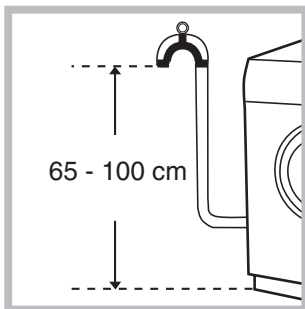

Connect the drain hose, without bending it, to a draining duct or a wall drain situated between 65 and 100 cm from the floor;

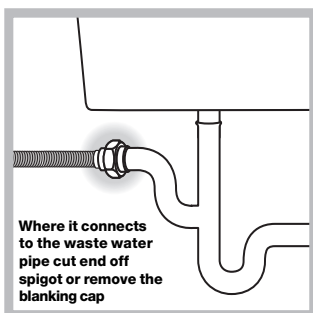

The drain hose may be connected to an under-sink trap. Before connecting the drain hose from the machine ensure that any blanks or removable ends have been taken off the spigot.

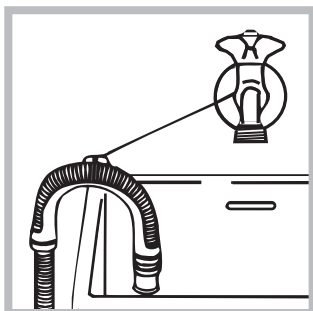

If it is place over the edge of a basin or sink be sure the free end of the hose should not be underwater.

! We advise against the use of hose extensions; in case of absolute need, the extension must have the same diameter as the original hose and must not exceed 150 cm in length.

Ensure that if the drain hose is pushed into a standpipe, that the end does not go down more than 15cms (6 inches). If the hose is pushed down too far, this may cause the machine to self-siphon i.e. continuously empty as it is filling.

Electric connection

Before plugging the appliance into the mains socket, make sure that:

- the socket is earthed and in compliance with the applicable law;
- the socket is able to sustain the appliance's maximum power load indicated in the Technical details table (see page 5);

- the supply voltage is included within the values indicated on the Technical details table (see page 5);
- the socket is compatible with the washer-dryer's plug. If this is not the case, replace the socket or the plug.

Your appliance is now supplied with a 13 amp fused plug it can be plugged into a 13 amp socket for immediate use. Before using the appliance please read the instructions below.

WARNING - THIS APPLIANCE MUST BE EARTHED. THE FOLLOWING OPERATIONS SHOULD BE CARRIED OUT BY A QUALIFIED ELECTRICIAN.

Replacing the fuse:

When replacing a faulty fuse, a 13 amp ASTA approved fuse to BS 1362 should always be used, and the fuse cover re-fitted. If the fuse cover is lost, the plug must not be used until a replacement is obtained.

Replacement fuse covers:

If a replacement fuse cover is fitted, it must be of the correct colour as indicated by the coloured marking or the colour that is embossed in words on the base of the plug. Replacements can be obtained directly from your nearest Service Depot.

Removing the plug:

If your appliance has a non-rewireable moulded plug and you should wish to re-route the mains cable through partitions, units etc., please ensure that either:

the plug is replaced by a fused 13 ampere re-wearable plug bearing the BSI mark of approval. or:

the mains cable is wired directly into a 13 amp cable outlet, controlled by a switch, (in compliance with BS 5733) which is accessible without moving the appliance.

Disposing of the plug:

Ensure that before disposing of the plug itself, you make the pins unusable so that it cannot be accidentally inserted into a socket.

Instructions for connecting cable to an alternative plug: Important: the wires in the mains lead are coloured in accordance with the following code:

Green & Yellow	Earth
Blue	Neutral
Brown	Live

GB

Installation

Description

Programmes

Detergents

Precautions

Care

Troubleshooting

Service

As the colours of the wires in the lead may not correspond with the coloured markings identifying the terminals in your plug, proceed as follows:
 Connect Green & Yellow wire to terminal marked **E** or \perp or coloured Green or Green & Yellow.
 Connect Brown wire to terminal marked **L** or coloured Red.
 Connect Blue wire to terminal marked **N** or coloured Black.

If a 13 amp plug (BS 1363) is used it must be fitted with a 13 amp fuse, either in the plug or adaptor or at the distribution board.

If you are in any doubt the electrical supply to your machine, consult a qualified electrician before use.

How to connect an alternative plug:

The wires in this mains lead are coloured in accordance with the following code:

BLUE	NEUTRAL (N)
BROWN	LIVE (L)
GREEN & YELLOW	EARTH (E)

Disposing of the appliance:

When disposing of the appliance please remove the plug by cutting the mains cable as close as possible to the plug body and dispose of it as described above.

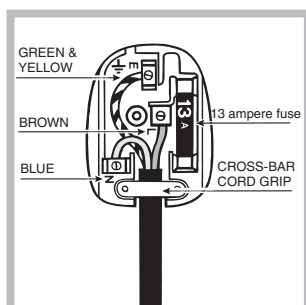

! The washing machine should not be installed in an outdoor environment, not even when the area is sheltered, because it may be very dangerous to leave it exposed to rain and thunderstorms.

! When the washing machine is installed, the mains socket must be within easy reach.

! Do not use extensions or multiple sockets.



! The power supply cable must never be bent or dangerously compressed.

! The power supply cable must only be replaced by an authorised serviceman.

Warning! The company denies all liability if and when these norms are not respected.

The first wash cycle

Once the appliance has been installed, and before you use it for the first time, run a wash cycle with detergent and no laundry, setting the 90°C programme without a pre-wash cycle.

Technical details	
Model	WIDE 127
Dimensions	59.5 cm wide 85 cm high 53.5 cm deep
Capacity	from 1 to 5 kg for the wash programme; from 1 to 4 kg for the drying programme
Electric connections	voltage 230/240 Volts 50 Hz maximum absorbed power 2050 W
Water connections	maximum pressure 1 MPa (10 bar) minimum pressure 0.05 MPa (0.5 bar) drum capacity 46 litres
Spin speed	up to 1200 rpm
Control programmes according to IEC456 directive	<p>Wash: programme 1; temperature 60°C; run with a load of 5 kg.</p> <p>Drying: first drying cycle performed with a 1 kg load, by selecting a drying time of 40 min; Second drying cycle performed with a 4 kg load, selecting the maximum drying level .</p>
 	<p>This appliance is compliant with the following European Community Directives:</p> <ul style="list-style-type: none"> - 73/23/CEE of 19/02/73 (Low Voltage) and subsequent amendments - 89/336/CEE of 03/05/89 (Electromagnetic Compatibility) and subsequent amendments - 2002/96/CE

GB
Installation
Description
Programmes
Detergents
Precautions
Care
Troubleshooting
Service

Washer-dryer description

GB

Control panel

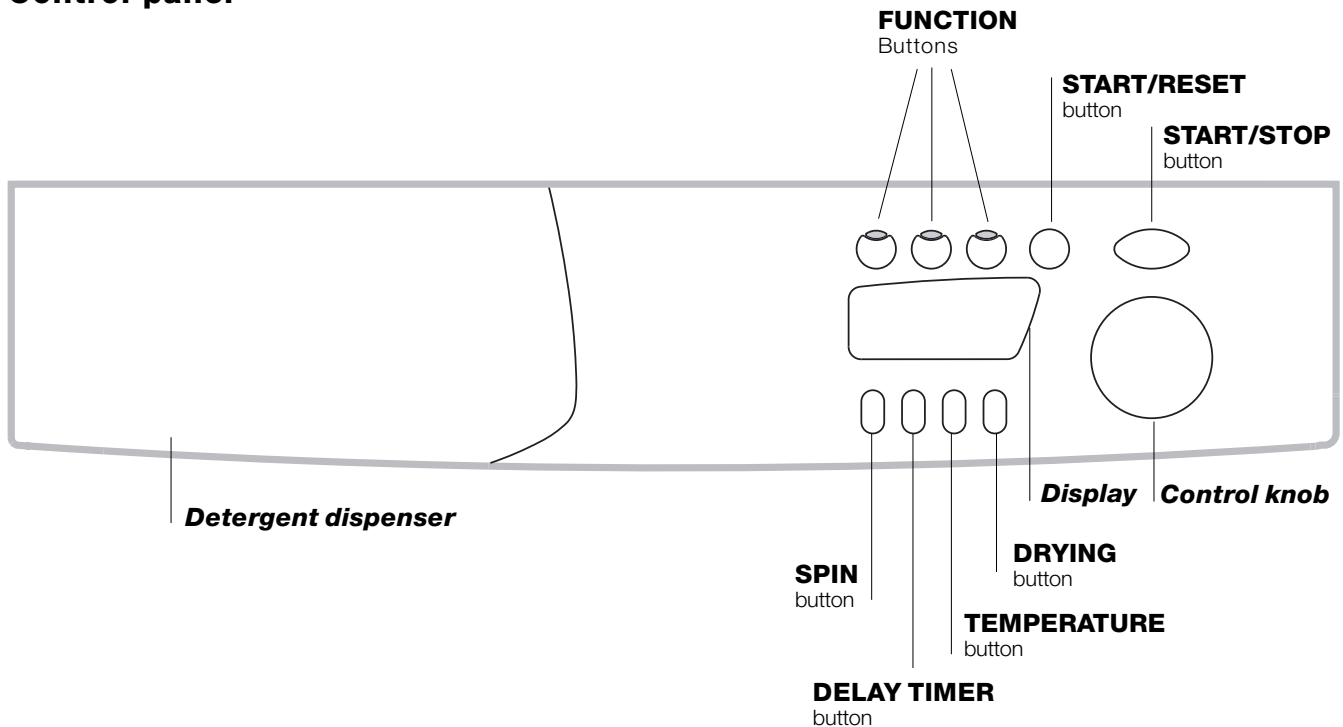

Detergent dispenser to add detergent and fabric softener (see page 11).

SPIN button to adjust the spin speed or exclude it altogether (see page 9).

DELAY TIMER button to delay the start of the set programme for a maximum period of 24 hours (see page 9).

TEMPERATURE button to adjust the wash temperature (see page 9).

DRYING button: to set the desired drying cycle (see page 9).

Display to programme the Washer-dryer and follow the wash cycle progress (see opposite page).

FUNCTION buttons: to select the functions available. The button corresponding to the function selected will remain on.

START/RESET button to start the programmes or cancel any incorrect settings.

START/STOP button to turn the Washer-dryer on and off.

Control knob to select the wash programmes. The knob stays still during the cycle.

Display

In addition to being a practical tool to programme your appliance (see page 9), the display provides useful information concerning the wash cycle.

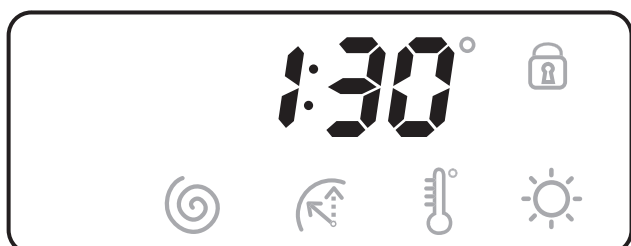

Once you have pressed the START/RESET button to start the programme, the display will indicate the amount of time left until the end of the wash cycle. If a delayed start has been set (using the Delay Timer, see page 9), the delay time will be indicated on the display.

Door lock:



If the symbol is on, the Washer-dryer door is locked to prevent it from being opened accidentally. To avoid any damages, wait for the symbol to switch itself off before you open the appliance door.

At the end of the programme, the word END is displayed.

! In the event of an anomaly, an error code will appear, such as: F-01, which should be communicated to the Service Centre (see page 14).

"MEMO" Programme

This programme allows you to store your favourite or most-used wash cycle.

All you have to do is set the desired programme and, once it has started, turn the KNOB to position ; the wash cycle will be stored automatically and the word MEMO appears on the display, flashing for a few seconds. Subsequently, you can start the "MEMO" cycle by simply turning the KNOB to position ; you will be able to see the temperature/spin cycle/delay timer values by pressing the corresponding buttons; you will also be able to modify them but this variation will only be valid for the programme in progress and it will not be stored in the "MEMO" cycle.

If you want to store a new wash cycle, repeat the above-mentioned operations.

GB

Installation

Description

Programmes

Detergents

Precautions

Care

Troubleshooting

Service





Starting and Programmes

GB

Briefly: starting a programme

1. Turn the Washer-dryer on by pressing button (I).
2. Load your laundry into the Washer-dryer and shut the appliance door.
3. Set the knob to the desired programme. The estimated duration of the selected programme is displayed. The temperature and spin speed are automatically set according to the programme (to change them, see page 9).
4. Set the drying cycle if necessary (see page 9).
5. Select any functions (see page 10).
6. Add the detergent and any fabric softener (see page 11).
7. Start the programme by pressing the START/RESET button for one second.
To cancel it, keep the START/RESET button pressed for at least 2 seconds.
8. When the programme has ended, the word END is displayed. Take out your laundry and leave the appliance door ajar to allow the drum to dry thoroughly.
9. Turn the Washer-dryer off by pressing button (I).

Programme table

Type of fabric and degree of soil	Prog.	Temp.	Drying Cycle	Detergent	Fabric softener	Cycle length (minutes)	Max. Spin Speeds (r.p.m.)	Description of wash cycle
				wash				
Standard								
Extremely soiled whites (sheets, tablecloths, etc.)	1	90°C	•	•	•	125	Max.	Wash cycle, rinse cycles, intermediate and final spin cycles
Heavily soiled whites and fast colours	1	60°C	•	•	•	110	Max.	Wash cycle, rinse cycles, intermediate and final spin cycles
Heavily soiled whites and delicate colours	1	40°C	•	•	•	105	Max.	Wash cycle, rinse cycles, intermediate and final spin cycles
Slightly soiled whites and delicate colours (shirts, jumpers, etc.)	2	40°C	•	•	•	70	Max.	Wash cycle, rinse cycles, intermediate and final spin cycles
Heavily soiled fast colours (baby linen, etc.)	3	50°C	•	•	•	75	800	Wash cycle, rinse cycles, anti-crease or delicate spin cycle
Heavily soiled fast colours (baby linen, etc.)	3	40°C	•	•	•	60	800	Wash cycle, rinse cycles, anti-crease or delicate spin cycle
Wool	4	40°C		•	•	50	600	Wash cycle, rinse cycles or delicate spin cycle
Very delicate fabrics (curtains, silk, viscose, etc.)	5	30°C		•	•	45	no	Wash cycle, rinse cycles, anti-crease or draining cycle
Drying cotton	6		•				Max.	
Drying delicates	7		•				no	
Time 4 you								
Heavily soiled whites and fast colours	8	60°C		•	•	65	Max.	Wash cycle, rinse cycles, intermediate and final spin cycles
Delicate colours (all types of slightly soiled garments)	9	40°C		•	•	45	800	Wash cycle, rinse cycles, delicate spin cycle
Delicate colours (all types of slightly soiled garments)	10	30°C	•	•	•	30	800	Wash cycle, rinse cycles and delicate spin cycle
Sport								
Sports shoes (MAX. 2 pairs)	11	30°C		•	•	50	800	Cold wash (without detergents), wash cycle, rinse cycles, and delicate spin cycle
Fabrics for sportswear (Tracksuits, shorts, etc.)	12	30°C		•	•	60	600	Wash cycle, rinse cycles, intermediate and final spin cycles
MEMO		Allows for any wash cycle to be stored (see page 7).						
PARTIAL PROGRAMMES								
Rinse			•		•		800	Rinse cycles and spin cycle
Spin cycle			•				800	Draining and spin cycle
Drain							no	Drain

Notes

- For programme 8, we advise against exceeding a wash load of 3.5 kg.
- For programme 12 we advise against exceeding a wash load of 2 kg.
- For the anti-crease function: see Easy iron (page 10). The information contained in the table is purely indicative.

Special programme

Daily (programme 10 for Synthetics) is designed to wash lightly soiled garments in a short amount of time: it only lasts 30 minutes and allows you to save on both time and energy. By setting this programme (10 at 30°C), you can wash different fabrics together (except for woollen and silk items), with a maximum load of 3 kg.
We recommend the use of liquid detergent.

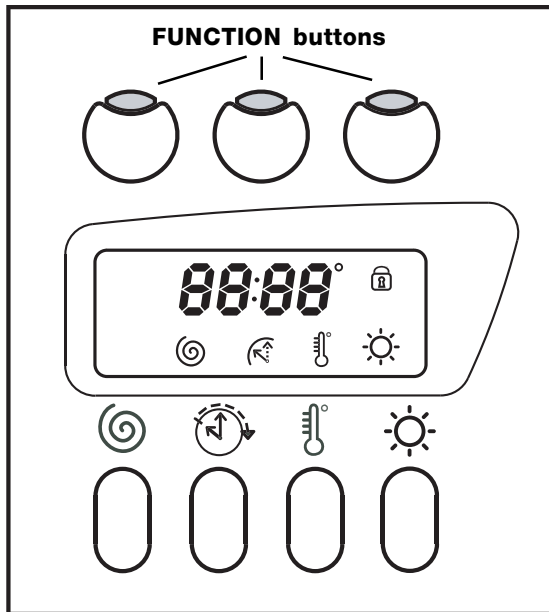

Setting the spin cycle

If, when the appliance is switched on, the KNOB is positioned on a programme with a spin cycle, a fixed appears. Press button and the maximum spin speed allowed for the programme set will be displayed, and the icon flashes. Press it again and the values lower until they reach OFF, which indicates that the spin cycle has been excluded (press it again to go back to the maximum value); stop on the desired speed, after approximately 2 seconds the setting is accepted: the symbol remains fixed. The spin cycle setting is enabled with all the programmes except for 5 and the Draining cycle.

Setting the delay timer

Press the button and you will see the word OFF on the display, while the relative symbol flashes. Press the button again and "1h" appears, that is, a delay of one hour (this can reach up to 24h); stop on the "desired" delay; after approximately 2 seconds the setting is accepted, following which, the time for the set programme appears on the display and the symbol remains on.

If you now press the START/RESET button, the set "delay" appears; this decreases every hour until the start of the cycle. In this phase, the "delay" can only be modified by decreasing it. The Delay Timer regulation is enabled with all programmes.

Setting the temperature

If, when the appliance is switched on, the KNOB is positioned on a programme for which the temperature needs to be regulated, a fixed appears. Press button and the maximum temperature allowed for the programme set will be displayed and the icon flashes. Press it again and the temperature lowers until it reaches OFF, which indicates a cold wash cycle (press it again to go back to the maximum value); stop on the desired value, after approximately 2 seconds the setting is accepted: the symbol remains fixed. The temperature adjustment is enabled with all wash programmes.

Setting the drying cycle

If, when the appliance is switched on, the KNOB is set to a programme requiring a drying setting, press button and the display will indicate the word OFF, while icon flashes. Press it again and the **Three times** (40'-1:20-2:00) and the **Three levels** of drying available will be displayed in sequence; stop at the desired type of drying; the setting will be accepted after approximately 2 seconds, then the time for the programme set (including the drying time) will be indicated on the display and the symbol will remain on.

The drying cycle setting cannot be made with programmes 4-5-8-9-11-12-15.

N.B.: if the KNOB is set to one of the programmes (6-7) dedicated to **drying only**, icon lights up permanently, press button and the drying level " — = " will be indicated while icon flashes; then to select the desired drying type, proceed as described above.

GB

Installation

Description

Programmes

Detergents

Precautions

Care

Troubleshooting

Service

Drying levels

Iron —: slightly damp clothes, easy to iron.

Hanger —= : dry clothes to put away.

Cupboard —=≡ : very dry clothes, recommended for towelling and bathrobes.

A cooling stage is foreseen at the end of the drying cycle.

If your laundry load to wash and dry is exceptionally in excess of the maximum load foreseen (see *table opposite*), perform the wash cycle, and when the programme is complete, divide up the garments and put part of them back in the drum. Now follow the instructions provided for a **dry only** cycle. Repeat this procedure for the remainder of the load.

Dry only

Set the PROGRAMME knob to one of the drying settings (6-7) depending on the type of fabric, then select the desired drying type.

Important:

- A spin cycle is carried out during the drying if you have set a **cotton programme**.

- If you set "spin cycle exclusion", you may not select a drying cycle.

If you wish to run a drying cycle, select the maximum spin speed available and then choose the type of drying required.

- For cotton loads of less than 1 Kg, use the drying programme designed for delicate fabrics.





Functions

To enable a function:

1. press the button corresponding to the desired function, according to the table below;
2. the function is enabled when the corresponding button is illuminated.

Note: The rapid flashing of the button indicates that the corresponding function cannot be selected for the programme set.

If you set a function that is incompatible with another function you selected previously, only the last one selected will be enabled.

Function	Effect	Comments	Enabled with programmes:
 Prewash	Allows you to perform a pre-wash.		1, 2, 3, 5
 Extra Rinse	Increases the efficiency of the rinse.	Recommended when the appliance has a full load or with large quantities of detergent.	1, 2, 3, 8, 9, 11, 12, Rinse cycle.
 Easy iron	This option reduces the amount of creasing on fabrics, making them easier to iron.	When this function is set, programmes 3 and 5 will end, with the laundry left to soak (Anti-crease), and the relative button flashes: - to conclude the cycle, press the START/RESET button or the EASY IRON button; - to run the draining cycle alone, set the knob to the relative symbol  and press the START/RESET button.	2, 3, 5, 8, 9, Rinse cycle.

! The machine has an intelligent built in check for out of balance loads. To let protect your machine it may reduce the final spin speed if an unbalanced load is detected.

Table of drying times

Fabric type	Load type	Max. load (kg)	—=≡ Cup-board	—= Hanger	— Iron
Cotton, Linen	Clothing of different sizes	4	130	120	110
Cotton	Terry towels	4	130	120	110
Terital, Cotton	Sheets, Shirts	2,5	90	80	70
Acrylics	Pyjamas, socks, etc.	1	65	60	60
Nylon	Slips, tights, stockings, etc.	1	65	60	60

The data contained in the table are purely indicative.

Detergent dispenser

Good washing results also depend on the correct dose of detergent: adding too much detergent won't necessarily make for a more efficient wash, and may in fact cause build up on the interior of your appliance and even pollute the environment.

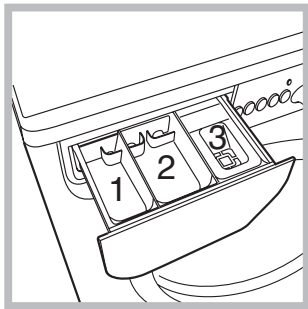

Open up the detergent dispenser and pour in the detergent and fabric softener, as follows.

compartment 1: Detergent for pre-wash (powder)

compartment 2: Detergent for the wash cycle (powder or liquid)

Liquid detergent should only be poured in immediately prior to the wash cycle start.

compartment 3: Additives (fabric softeners, etc.)

The fabric softener should not overflow from the grid.

! Do not use hand wash detergent because it may form too much foam.

Preparing your laundry

- Divide your laundry according to:
 - the type of fabric/the symbol on the label.
 - the colours: separate coloured garments from whites.
- Empty all pockets and check for loose buttons.
- Do not exceed the weight limits stated below, which refer to the weight when dry:
 - Sturdy fabrics: max 5 kg
 - Synthetic fabrics: max 2.5 kg
 - Delicate fabrics: max 2 kg
 - Wool: max 1 kg

How much does your laundry weigh?

- 1 sheet 400-500 g
- 1 pillow case 150-200 g
- 1 tablecloth 400-500 g
- 1 bathrobe 900-1,200 g
- 1 towel 150-250 g

Special items

Curtains: fold curtains and place them in a pillow case or mesh bag. Wash them separately without exceeding half the appliance load. Use programme 5 which excludes the spin cycle automatically.

Quilted coats and windbreakers: if they are padded with goose or duck down, they can be machine-washed. Turn the garments inside out and load a maximum of 2-3 kg, repeating the rinse cycle once or twice and using the delicate spin cycle.

Wool: for best results, use a specific detergent, taking care not to exceed a load of 1 kg.

Woolmark



As gentle as a hand wash.

Indesit sets a new standard of superior performance that has been endorsed by The Woolmark Company with the prestigious Woolmark brand. Look for the Woolmark logo on the washing machine to ensure you can safely and effectively wash wool garments labelled as "hand wash" (M.00221):

Set programme 4 for all "Hand wash" garments  (max 1 kg) , using the appropriate detergent.

GB

Installation

Description

Programmes

Detergents

Precautions

Care

Troubleshooting

Service

Precautions and advice

GB

! The Washer-dryer was designed and built in compliance with the applicable international safety regulations. The following information is provided for your safety and should consequently be read carefully.

General safety

- This appliance has been designed for non-professional, household use and its functions must not be changed.
- This washing machine should only be used by adults and in accordance with the instructions provided in this manual.
- Never touch the washing machine when barefoot or with wet or damp hands or feet.
- Do not pull on the power supply cable to unplug the appliance from the electricity socket. Pull the plug out yourself.
- Do not open the detergent dispenser while the appliance is in operation.
- Do not touch the drain water as it could reach very high temperatures.
- Never force the washing machine door: this could damage the safety lock mechanism designed to prevent any accidental openings.
- In the event of a malfunction, do not under any circumstances touch internal parts in order to attempt repairs.
- Always keep children well away from the appliance while in operation.
- The appliance door tends to get quite hot during the wash cycle.
- Should it have to be moved, proceed with the help of two or three people and handle it with the utmost care. Never try to do this alone, because the appliance is very heavy.
- Before loading your laundry into the washing machine, make sure the drum is empty.
- During the drying phase, the door tends to get quite hot.
- Do not use the appliance to dry clothes that have been washed with flammable solvents (e.g. trichlorethylene).
- Do not use the appliance to dry foam rubber or similar elastomers.
- Make sure that the water tap is turned on during the drying cycles.
- This washer-dryer can only be used to dry clothes which have been pre-washed in water.

Disposal

- Disposing of the packaging material: observe local regulations, so the packaging can be re-used.
- The European Directive 2002/96/EC on Waste Electrical and Electronic Equipment, requires that old household electrical appliances must not be

disposed of in the normal unsorted municipal waste stream. Old appliances must be collected separately in order to optimise the recovery and recycling of the materials they contain and reduce the impact on human health and the environment. The crossed out "wheeled bin" symbol on the product reminds you of your obligation, that when you dispose of the appliance it must be separately collected.

Consumers should contact their local authority or retailer for information concerning the correct disposal of their old appliance.

Saving energy and respecting the environment

Environmentally-friendly technology

If you only see a little water through your appliance door, this is because thanks to the latest Ariston technology, your washing machine only needs less than half the amount of water to get the best results: an objective reached to respect the environment.

Saving on detergent, water, energy and time

- To avoid wasting resources, the Washer-dryer should be used with a full load. A full load instead of two half loads allows you to save up to 50% on energy.
- The pre-wash cycle is only necessary on extremely soiled garments. Avoiding it will save on detergent, time, water and between 5 and 15% energy.
- Treating stains with a stain remover or leaving them to soak before washing will cut down the need to wash them at high temperatures. A programme at 60°C instead of 90°C or one at 40°C instead of 60°C will save up to 50% on energy.
- Use the correct quantity of detergent depending on the water hardness, how soiled the garments are and the amount of laundry you have, to avoid wastage and to protect the environment: despite being biodegradable, detergents do contain ingredients that alter the natural balance of the environment. In addition, avoid using fabric softener as much as possible.
- If you use your washing machine from late in the afternoon until the early hours of the morning, you will help reduce the electricity board's peak load. The Delay Timer option (see page 9) helps to organise your wash cycles accordingly.
- If your laundry has to be dried in a tumble dryer, select a high spin speed. Having the least water possible in your laundry will save you time and energy in the drying process.

Cutting off the water or electricity supply

- Turn off the water tap after every wash. This will limit the wear of your appliance's water system and also prevent leaks.
- Unplug your appliance when cleaning it and during all maintenance operations.

Cleaning your appliance

The exterior and rubber parts of your appliance can be cleaned with a soft cloth soaked in lukewarm soapy water. Do not use solvents or abrasives.

Cleaning the detergent dispenser

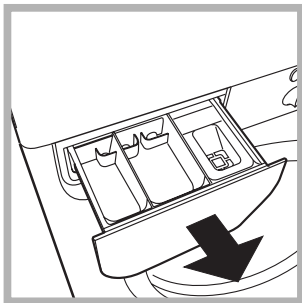

Remove the dispenser by pulling it out (see figure). Wash it under running water; this operation should be repeated frequently.

Caring for your appliance door and drum

- Always leave the appliance door ajar to prevent unpleasant odours from forming.

Cleaning the pump

The Washer-dryer is fitted with a self-cleaning pump that does not require any maintenance. Sometimes, small items (such as coins or buttons) may fall into the pre-chamber that protects the pump, situated in the lower part of the same.

! Make sure the wash cycle has ended and unplug the appliance.

To access the pre-chamber:

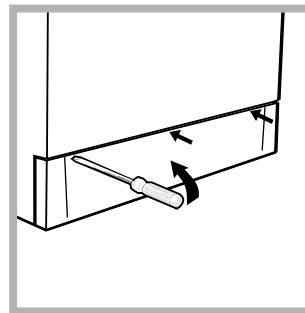

1. using a screwdriver, remove the cover panel on the lower front of the Washer-dryer (see figure);

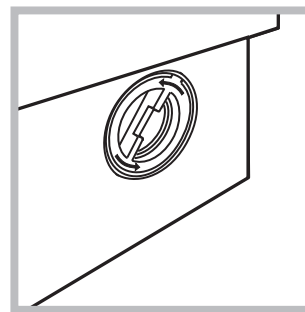

2. unscrew the lid rotating it anti-clockwise (see figure): a little water may trickle out. This is perfectly normal;

3. clean the interior thoroughly;
4. screw the lid back on;
5. reposition the panel, making sure the hooks are securely in place before you push it onto the appliance.

Checking the water inlet hose

Check the water inlet hose at least once a year. If you see any cracks, replace it immediately: during the wash cycles, water pressure is very strong and a cracked hose could easily split open.

! Never use hoses that have already been used.

GB

Installation

Description

Programmes

Detergents

Precautions

Care

Troubleshooting

Service

Troubleshooting

GB

Your washing machine could fail to work. Before calling for Assistance (*see page 14*), make sure the problem can't easily be solved by consulting the following list.

Problem

The washing machine won't start.

Possible causes/Solution:

- The appliance is not plugged into the socket, or not enough to make contact.
- There has been a power failure.
- The appliance door is not shut properly (the word DOOR is displayed).
- The  button has not been pressed.
- The START/RESET button has not been pressed.

NB: It should be held minimum one second.

- The water tap is not turned on.
- A delayed start has been set (using the Delay Timer, *see page 9*).

The washing machine does not fill with water (The wording H2O is displayed).

- The water inlet hose is not connected to the tap.
- The hose is bent.
- The water tap is not turned on.
- There is a water shortage.
- The water pressure is insufficient.
- The START/RESET button has not been pressed.

The machine continuously fills and empties with water.

- The drain hose is too low or too far in to the stand pipe (*see page 3*) for correct installation.
- The wall drainage system doesn't have a standard pipe (min. 38 mm).

The washing machine does not drain or spin.

- Some programs have a slower final spin to take best care of the fabrics. *See page 8* for details of the final spin speed for each program.
- The programme does not foresee the draining: some programmes require enabling the draining manually (*see page 8*).
- The Easy iron option is enabled: to complete the programme, press the START/RESET button (*see page 9*).
- The drain hose is bent (*see page 3*).
- Remove the drain hose from the standpipe or under-sink trap and check for blockages, ensuring that the water can drain freely away from the machine.

The washing machine vibrates too much during the spin cycle.

- When the machine is installed, the locking screws for the oscillating assembly are still in place. Remove the screws (*see page 2*).
- The washing machine is not level (*see page 2*).
- The washing machine is closed in between furniture cabinets and the wall (*see page 2*).

The washing machine leaks.

- The water inlet hose is not screwed on correctly (*see page 2*).
- The detergent dispenser is obstructed (to clean it, *see page 12*).
- The drain hose is not secured properly (*see page 3*).

The machine is locked and the display flashes, indicating an error code (e.g. F-01, F-..).

- This means there is a problem with the machine. Before calling Assistance, please follow the set of instructions below:
 1. Switch off the machine;
 2. Remove the plug connecting the appliance to the mains supply and wait for at least 40 seconds;
 3. Place the plug back into the socket;
 4. Switch on the machine;
 5. If the problem is still evident after this process has been carried out, contact Assistance.

There is too much foam.

- The detergent is not suitable for machine washing (it should bear the definition "for washing machines" or "hand and machine wash", or the like).
- You used too much detergent.

The washer-dryer does not dry.

- The appliance is not plugged into the socket, or not enough to make contact.
- There has been a power failure.
- The appliance door is not shut properly.
- A delayed start has been set (using the Delay Timer, *see page 9*).

Before calling for Assistance:

- Check whether you can solve the problem on your own (see page 14);
- Restart the programme to check whether the problem has been solved;
- If this is not the case, contact an authorised Technical Service Centre on the telephone number provided on the guarantee certificate.

! If the machine has been installed or used incorrectly, you may be charged for the maintenance callout service.

! Always request the assistance of authorised servicemen.

Notify the operator of:

- the type of problem;
- the appliance model (Mod.);
- the serial number (S/N).

This information can be found on the data plate situated on the rear of the Washer-dryer.

GB

Installation

Description

Programmes

Detergents

Precautions

Care

Troubleshooting

Service

Free Manuals Download Website

<http://myh66.com>

<http://usermanuals.us>

<http://www.somanuals.com>

<http://www.4manuals.cc>

<http://www.manual-lib.com>

<http://www.404manual.com>

<http://www.luxmanual.com>

<http://aubethermostatmanual.com>

Golf course search by state

<http://golfingnear.com>

Email search by domain

<http://emailbydomain.com>

Auto manuals search

<http://auto.somanuals.com>

TV manuals search

<http://tv.somanuals.com>