



INFINITY CLASSIA™ SPEAKERS

OWNER'S GUIDE

C205

C336

CC225



INFINITY CLASSIA™ SERIES

The Infinity Classia™ series of loudspeakers continues the longstanding Infinity® commitment to accurate sound reproduction. Our patented Ceramic Metal Matrix Diaphragm (CMMD®) drivers, precision dividing networks and rigid, well-braced enclosures combine to deliver uncompromised performance in any stereo or multichannel home theater system. In addition, Infinity Classia speakers are magnetically shielded for safe placement adjacent to a television.

UNPACKING THE SPEAKERS

If you suspect damage from transit, report it immediately to your dealer. Keep the shipping carton and packing materials for future use.

WHAT'S INCLUDED

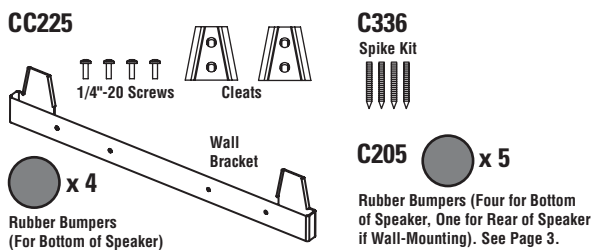

PLACEMENT

Stereo

Before deciding where to place your speakers, survey your room and think about placement, keeping the following points in mind, using Figure 1 as a guide:

- For best results, place the speakers 6'–8' apart.
- Position each speaker so that the tweeter is approximately at ear level.
- Generally, bass output will increase as the speaker is moved closer to a wall or corner.
- Refer to the "Home Theater" section if you also plan to use the speakers for home theater reproduction.

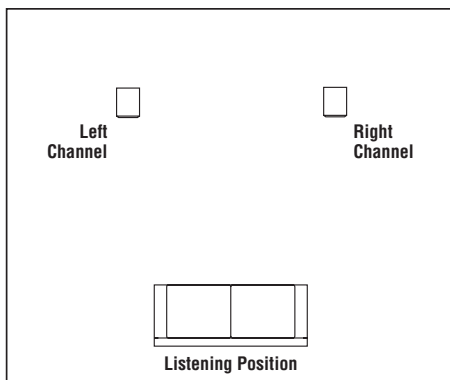

Figure 1. Experiment with speaker placement to obtain the best bass level and stereo imaging in your room.

HOME THEATER

For front-channel use, place one speaker on the left and another on the right, along either side of the television monitor. Since the speakers are magnetically shielded, you can place them without worrying about the field distorting the TV picture.

For surround use, place speakers alongside the listening position. Final placement depends on room acoustics, availability of space and your listening preference (Figures 2 and 3).

The CC225 center channel speaker should be placed on top of or directly below the television and aimed toward the listening area. The CC225 speaker may also be wall-mounted. See page 3.

NOTE: An Infinity powered subwoofer will add impact and realism to both music and film soundtracks. Contact your Infinity dealer for recommendations on subwoofer models for your application.

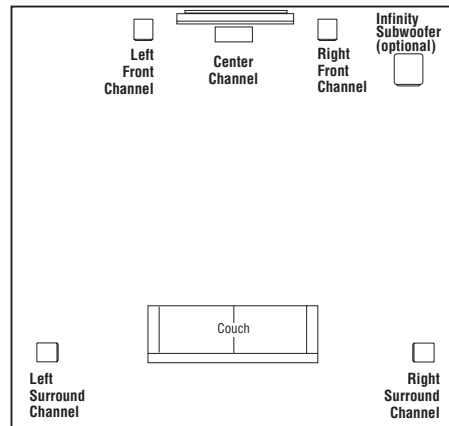

Figure 2. This overhead view shows a typical home theater plan.

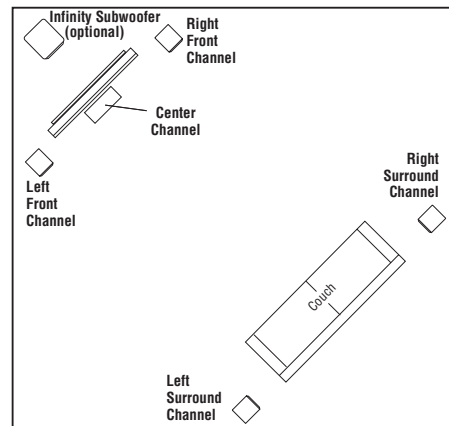

Figure 3. This figure shows an alternate layout, which may be more suitable for some rooms.

WALL-MOUNTING THE C205

The C205 is designed to be mounted directly to a wall. Each speaker has two keyholes on the back, and will require (2) 1-1/2," #8 wood screws with a .33" (8.4mm) screwhead fastened to a wall stud. If a wall stud is unavailable, install an anchor appropriate for a 1-1/2," #8 screw.

NOTE: The customer is responsible for the correct selection and use of mounting hardware (available through hardware stores) that will ensure the proper and safe wall-mounting of the speakers.

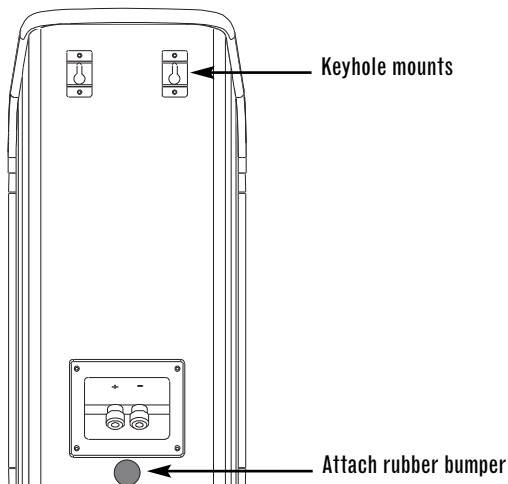

Figure 4.

Step 1.

Mark the positions on the wall where you would like to place the mounting screws.

Step 2.

Fasten two 1-1/2," #8 wood screws to the wall using the markings placed in Step 1 as your guide. Leave an 11/16" space between the wall and screwhead. If a wall stud is not available, use an appropriate anchor.

Step 3.

Place the speaker on the wall by aligning the keyholes on the back of the speaker to the screwheads on the wall. Once positioned properly, the speaker should slide down slightly and become secure.

INSTALLING SPIKED FEET

C336

Four metal spikes are supplied for use when using the outboard feet and the speaker is to be placed on a carpeted surface to decouple the speaker from the floor and prevent unwanted damping. To insert the spikes, gently lay the speaker on its back (not its front or side) on a soft, nonabrasive surface, unscrew the four rubber-tipped feet and store in a safe place. Each spike then screws into the threaded insert. Make sure all four spikes are screwed in completely for stability.

NEVER drag the speaker to move it, as this will damage the spikes, the feet, the wood cabinet itself, and/or the floor. Always lift the speaker and carry it to its new location.

WALL-MOUNTING THE CC225

The CC225 is designed to be mounted directly to a wall. The bracket has four holes on the back, and will require (4) 1-1/2," #8 wood screws with a .33" (8.4mm) screwhead fastened to wall studs. If wall studs are unavailable, install anchors appropriate for a 1-1/2," #8 screw.

NOTE: The customer is responsible for the correct selection and use of mounting hardware (available through hardware stores) that will ensure the proper and safe wall-mounting of the speakers.

Step 1.

Attach the wall bracket to the wall at the desired location.

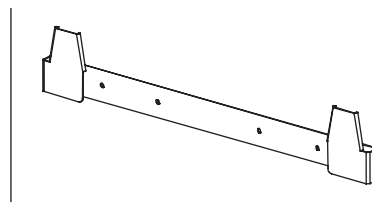

Step 2.

Securely fasten the two cleats to the rear of the speaker, using two included 1/4"-20 panhead screws per cleat.

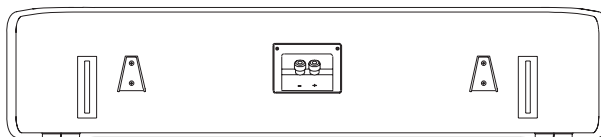

Step 3.

Carefully slide the cleats on the rear of the speakers over the tabs of the wall bracket.

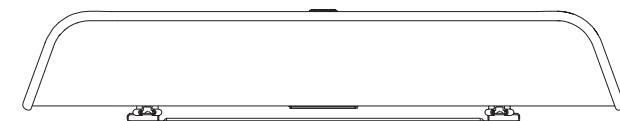
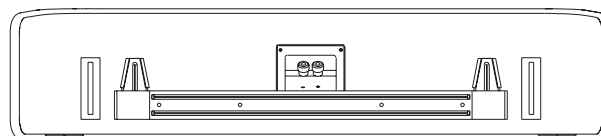

Top view

WIRING THE SYSTEM

IMPORTANT: Make sure all equipment is turned off before making any connections.

For speaker connections, use a minimum #16-gauge speaker wire with polarity coding. The side of the wire with a ridge or other coding is usually considered positive polarity (i.e., +).

NOTE: If desired, consult your local Infinity dealer about speaker wire and connection options.

The speakers have coded terminals that accept a variety of wire connectors. The most common connection is shown in Figure 5.

To ensure proper polarity, connect each + terminal on the back of the amplifier or receiver to the respective + (red) terminal on each speaker, as shown in Figure 6. Connect the - (black) terminals in a similar way. See the owner's guides that were included with your amplifier, receiver and television to confirm connection procedures.

IMPORTANT: Do not reverse polarities (i.e., + to -, or - to +) when making connections. Doing so will cause poor imaging and diminished bass response.

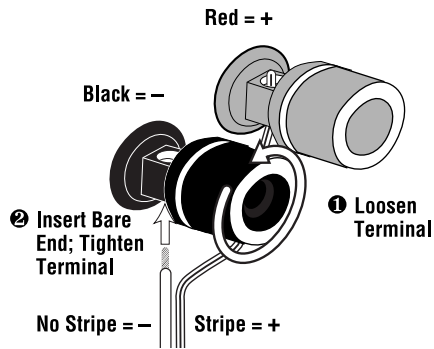

Figure 5. This example shows how to connect bare wires to the terminals.

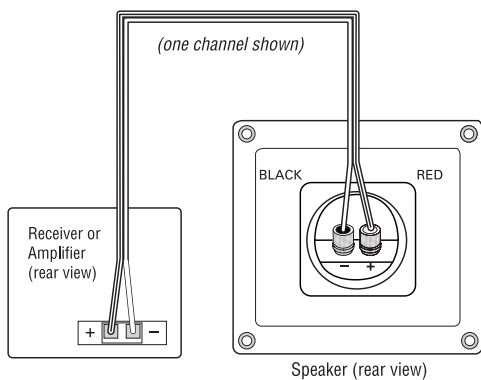

Figure 6. Wiring diagram shows polarity connections for one channel of a stereo or home theater system.

BI-WIRING

C336

The outer connection panel and internal dividing network of the C336 is designed so that separate sets of speaker cables can be attached to the low-frequency transducer and midrange/high-frequency transducer portions of this dividing network. This is called bi-wiring. Bi-wiring can provide several sonic advantages and considerably more flexibility in power amplifier selection.

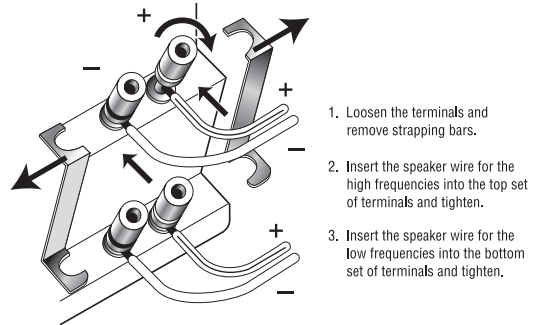

Figure 7.

Single-Stereo Amplifier

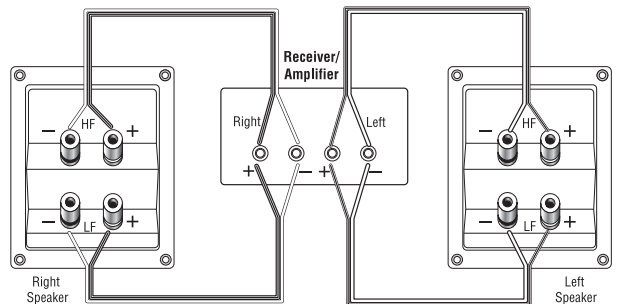

Figure 8.

Dual-Stereo Amplifier

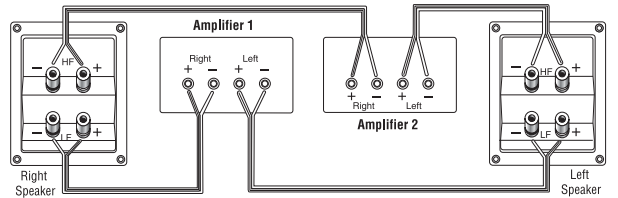

Figure 9.

FINAL ADJUSTMENTS

Check the speakers for playback, first by setting the system volume control to a minimum level, and then by applying power to your audio system. Play a favorite music or video segment and increase the system volume control to a comfortable level.

NOTE: You should hear balanced audio reproduction across the entire frequency spectrum. If not, check all wiring connections or consult the authorized Infinity dealer from whom you purchased the system for more help.

The amount of bass you hear and the stereo-image quality will be affected by a number of different factors, including the room's size and shape, the construction materials used to build the room, the listener's position relative to the speakers, and the position of the speakers in the room.

Listen to a variety of music selections and note the bass level. If there is too much bass, move the speakers away from nearby walls. Conversely, if you place the speakers closer to the walls, there will be more bass output.

Nearby reflecting surfaces can adversely affect stereo-imaging quality. If this happens, try angling the speakers slightly inward toward the listening position until the optimal effect is achieved.

CARE OF YOUR SPEAKER SYSTEM

Each Infinity Classia cabinet has a finish that does not require any routine maintenance. When needed, use a soft cloth to remove any fingerprints or dust. Clean the grille by gentle vacuuming.

NOTE: Do not use any cleaning products or polishes on the cabinet or grille.

In the event that your Infinity speaker needs service, contact your Infinity dealer or distributor, or visit www.infinitysystems.com for the location of the nearest service center.

SPECIFICATIONS

| | C205 | C336 | CG225 |
|---|--|---|---|
| Frequency Ranges: | 60Hz – 30kHz (–3dB) 55Hz – 40kHz (–6dB) | 40Hz – 30kHz (–3dB) 35Hz – 40kHz (–6dB) | 55Hz – 30kHz (–3dB) 50Hz – 40kHz (–6dB) |
| Recommended Amplifier Power Range: | 10 – 125 Watts | 10 – 250 Watts | 10 – 150 Watts |
| Sensitivity (2.83V @ 1 meter): | 88dB | 91dB | 90dB |
| Nominal Impedance: | 8 Ohms | 8 Ohms | 8 Ohms |
| Crossover Frequencies: | 2.0kHz; 24dB/octave | 500Hz, 2.8kHz; 24dB/octave | 2.0kHz; 24dB/octave |
| Low-Frequency Driver(s): | 5-1/4" (133mm) CMMD, [®] magnetically shielded | Triple 6-1/2" (165mm) CMMD, [®] magnetically shielded | Dual 5-1/4" (133mm) CMMD, [®] magnetically shielded |
| Mid-Frequency Driver: | N/A | 4" (100mm) CMMD, magnetically shielded | N/A |
| High-Frequency Driver: | 1" (25mm) CMMD, magnetically shielded | 1" (25mm) CMMD, magnetically shielded | 1" (25mm) CMMD, magnetically shielded |
| Dimensions (H x W x D): | 15-1/8" x 7-1/2" x 9-1/4" (384mm x 190mm x 235mm) | 48-3/4" x 8-1/2" x 10-1/2" (1238mm x 216mm x 267mm) | 6-7/8" x 31-3/4" x 5" (175mm x 806mm x 127mm) |
| Weight: | 10.8 lb (4.9kg) | 56.1 lb (25.4kg) | 16 lb (7.3kg) |

Features, specifications and appearance are subject to change without notice.

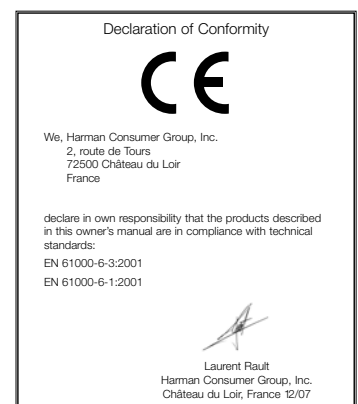

NOTES



TECHNOLOGY • PERFORMANCE • DESIGN

© 2007 Harman International Industries, Incorporated. All rights reserved.

Infinity Systems, 250 Crossways Park Drive, Woodbury, NY 11797 USA 516.674.4463 (USA only) www.infinitysystems.com

Infinity and CMMD (patent nos. 6,327,372 and 6,404,897) are trademarks of Harman International Industries, Incorporated, registered in the United States and/or other countries. Infinity Classia is a trademark of Harman International Industries, Incorporated.

Part No. B0-13333-01 12/07

H A Harman International Company



Free Manuals Download Website

<http://myh66.com>

<http://usermanuals.us>

<http://www.somanuals.com>

<http://www.4manuals.cc>

<http://www.manual-lib.com>

<http://www.404manual.com>

<http://www.luxmanual.com>

<http://aubethermostatmanual.com>

Golf course search by state

<http://golfingnear.com>

Email search by domain

<http://emailbydomain.com>

Auto manuals search

<http://auto.somanuals.com>

TV manuals search

<http://tv.somanuals.com>