



INFINITY CLASSIA™
COMPACT POWERED SUBWOOFER

OWNER'S GUIDE
PSW310W (120V)



IMPORTANT SAFETY PRECAUTIONS

READ FIRST!

1. Read these instructions.
2. Keep these instructions.
3. Heed all warnings.
4. Follow all instructions.
5. Do not use this apparatus near water.
6. Clean only with a dry cloth.
7. Do not block any ventilation openings. Install in accordance with the manufacturer's instructions.
8. Do not install near any heat sources such as radiators, heat registers, stoves or other apparatus (including amplifiers) that produce heat.
9. Do not defeat the safety purpose of the polarized or grounding-type plug. A polarized plug has two blades with one wider than the other. A grounding-type plug has two blades and a third grounding prong. The wide blade or the third prong is provided for your safety. If the provided plug does not fit into your outlet, consult an electrician for replacement of the obsolete outlet.
10. Protect the power cord from being walked on or pinched, particularly at plugs, convenience receptacles and the point where they exit from the apparatus.
11. Only use attachments/accessories specified by the manufacturer.
12. Use only with the cart, stand, tripod, bracket or table specified by the manufacturer or sold with the apparatus. When a cart is used, use caution when moving the cart/apparatus combination to avoid injury from tip-over.
13. Unplug this apparatus during lightning storms or when unused for long periods of time.



14. Refer all servicing to qualified service personnel. Servicing is required when the apparatus has been damaged in any way, such as power supply cord or plug is damaged, liquid has been spilled or objects have fallen into the apparatus, or the apparatus has been exposed to rain or moisture, does not operate normally or has been dropped.
15. Do not expose this apparatus to dripping or splashing and ensure that no objects filled with liquids, such as vases, are placed on the apparatus.
16. To completely disconnect this apparatus from the AC Mains, disconnect the power supply cord plug from the AC receptacle.
17. The mains plug of the power supply cord shall remain readily operable.
18. Do not expose batteries to excessive heat such as sunshine, fire or the like.



The lightning flash with arrowhead symbol, within an equilateral triangle, is intended to alert the user to the presence of uninsulated "dangerous voltage" within the product's enclosure that may be of sufficient magnitude to constitute a risk of electric shock to persons.



The exclamation point within an equilateral triangle is intended to alert the user to the presence of important operating and maintenance (servicing) instructions in the literature accompanying the product.
WARNING: To reduce the risk of fire or electric shock, do not expose this apparatus to rain or moisture.

FEDERAL COMMUNICATIONS COMMISSION INTERFERENCE STATEMENT

This equipment has been tested and found to comply with the limits for a Class B digital device, pursuant to Part 15 of the FCC Rules. These limits are designed to provide reasonable protection against harmful interference in a residential installation.

This equipment generates, uses and can radiate radio frequency energy and, if not installed and used in accordance with the instructions, may cause harmful interference to radio communications. However, there is no guarantee that interference will not occur in a particular installation. If this equipment does cause harmful interference to radio or television reception, which can be determined by turning the equipment off and on, the user is encouraged to try to correct the interference by one of the following measures:

- Reorient or relocate the receiving antenna.
- Increase the separation between the equipment and receiver.
- Connect the equipment into an outlet on a circuit different from that to which the receiver is connected.
- Consult the dealer or an experienced radio/TV technician for help.

FCC Caution: To assure continued compliance, any changes or modifications not expressly approved by the party responsible for compliance could void the user's authority to operate this equipment. (Example – use only shielded interface cables when connecting to computer or peripheral devices.)

FCC Radiation Exposure Statement

This equipment complies with FCC RF radiation exposure limits set forth for an uncontrolled environment. This equipment should be installed and operated with a minimum distance of 20 centimeters between the radiator and your body.

This device complies with Part 15 of the FCC Rules. Operation is subject to the following two conditions:
(1) This device may not cause harmful interference, and
(2) This device must accept any interference received, including interference that may cause undesired operation.

INFINITY CLASSIA™ PSW310W OWNER'S GUIDE

Table of Contents

ii	Important Safety Precautions
1	Unpacking the Subwoofer
1	Placement
2	Controls and Connections
3	System Connections
4	Operation
5	Room Adaptive Bass Optimization System (R.A.B.O.S.)
6	Contents of the R.A.B.O.S. Test CD
6	The R.A.B.O.S. Sound-Level Meter (RSLM)
6	RSLM Placement
7	Initial System-Level Setting
7	Setting the Subwoofer Test Level
7	Performing Low-Frequency Measurements
9	What Does a Parametric Equalizer Do?
9	Completing the R.A.B.O.S. Measurement Template
10	Using the Width Selector
11	Level
11	What You Measure, What to Do
14	Adjusting the R.A.B.O.S. Equalizer
15	Final System Balance
16	Maintenance and Service
17	R.A.B.O.S. Measurement Templates
19	Specifications

INFINITY CLASSIA™ PSW310W

The Infinity Classia PSW310W continues the legendary Infinity® dedication to accurate sound reproduction. The patented Ceramic Metal Matrix Diaphragm (CMMD®) drivers, high-powered amplifier and proprietary Room Adaptive Bass Optimization System™ (R.A.B.O.S.™) technology, along with a rigid, well-braced enclosure, combine to deliver uncompromised bass performance in any stereo or multichannel home theater.

In addition, the PSW310W's compact enclosure and wireless capability allow for easy integration into any residential environment.

UNPACKING THE SUBWOOFER

If you suspect damage from transit, report it immediately to your dealer. Keep the shipping carton and packing materials for future use.

Included

- 1 x Owner's manual
- 1 x USA warranty sheet
- 1 x Subwoofer
 - 1 x 15' (4.5m) Audio cable, RCA-RCA
 - 4 x Spiked feet
- 1 x Transmitter module
 - 1 x Power supply for transmitter
 - 1 x 120V two-prong AC power cord for transmitter power supply
 - 1 x 6' Audio cable, RCA-RCA
 - 1 x Wall-mount bracket for transmitter
- 2 x With two panhead M3 x 4 machine screws for attaching wall-mount bracket to transmitter
- 4 x Small, round, self-adhesive feet – to be attached on transmitter's left-side panel if transmitter is to be used vertically

PLACEMENT

Since the installation of a subwoofer can be somewhat more complicated than installing full-range speakers, it is essential that you read this section very carefully prior to connecting the subwoofer to your system. Should you have questions relating to your installation, it is advisable to call either your dealer or the Infinity Customer Service Department for advice.

The performance of the subwoofer is directly related to its placement in the listening room and how you align the subwoofer with its satellite speakers. The PSW310W's wireless capability makes it even easier to properly locate the subwoofer in your room. Setting the volume of the subwoofer in relation to the left and right speakers is also of critical importance because it is essential that the subwoofer integrate smoothly with the entire system. Setting the subwoofer's volume level too high will result in an overpowering, boomy bass. Setting the volume level too low will negate the benefits of the subwoofer.

Here are several additional facts on installation that may prove useful. It is generally believed by most audio authorities that low frequencies (below 125Hz) are nondirectional and, therefore, placement of a subwoofer within any listening room is not critical. While in theory it is true that the larger wavelengths of extremely low frequencies are basically nondirectional, the fact is that, when installing a subwoofer within the limited confines of a room, reflections, standing waves and absorptions generated within the room will strongly influence the performance of any subwoofer system. As a result, the specific location of the subwoofer becomes important, and it is strongly recommended that you experiment with placement before choosing a final location.

Placement will depend upon your room and the amount and quality of bass required (for example, whether or not your room permits placement of the subwoofer near either satellite).

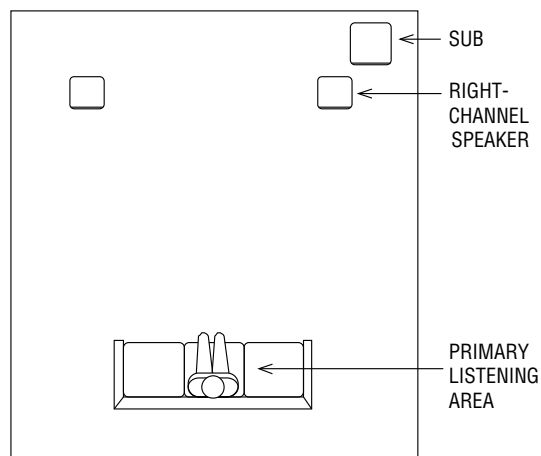

Figure 1. This example shows the subwoofer positioned behind the right-channel satellite speaker to re-create the actual location of bass instruments in an orchestra and/or add impact to movie soundtracks.

INSTALLING SPIKED FEET

Four metal spikes are supplied for use when the subwoofer is to be placed on a carpeted surface to decouple the subwoofer from the floor and prevent unwanted damping. To insert the spikes, gently lay the subwoofer on its back (not on its front or side) on a soft, nonabrasive surface. Each spike screws into the threaded insert. Make sure all four spikes are screwed in completely for stability.

NEVER drag the subwoofer to move it, as this will damage the spikes, the feet, the wood cabinet itself and/or the floor. Always lift the subwoofer and carry it to its new location.

CONTROLS AND CONNECTIONS

Rear Panel

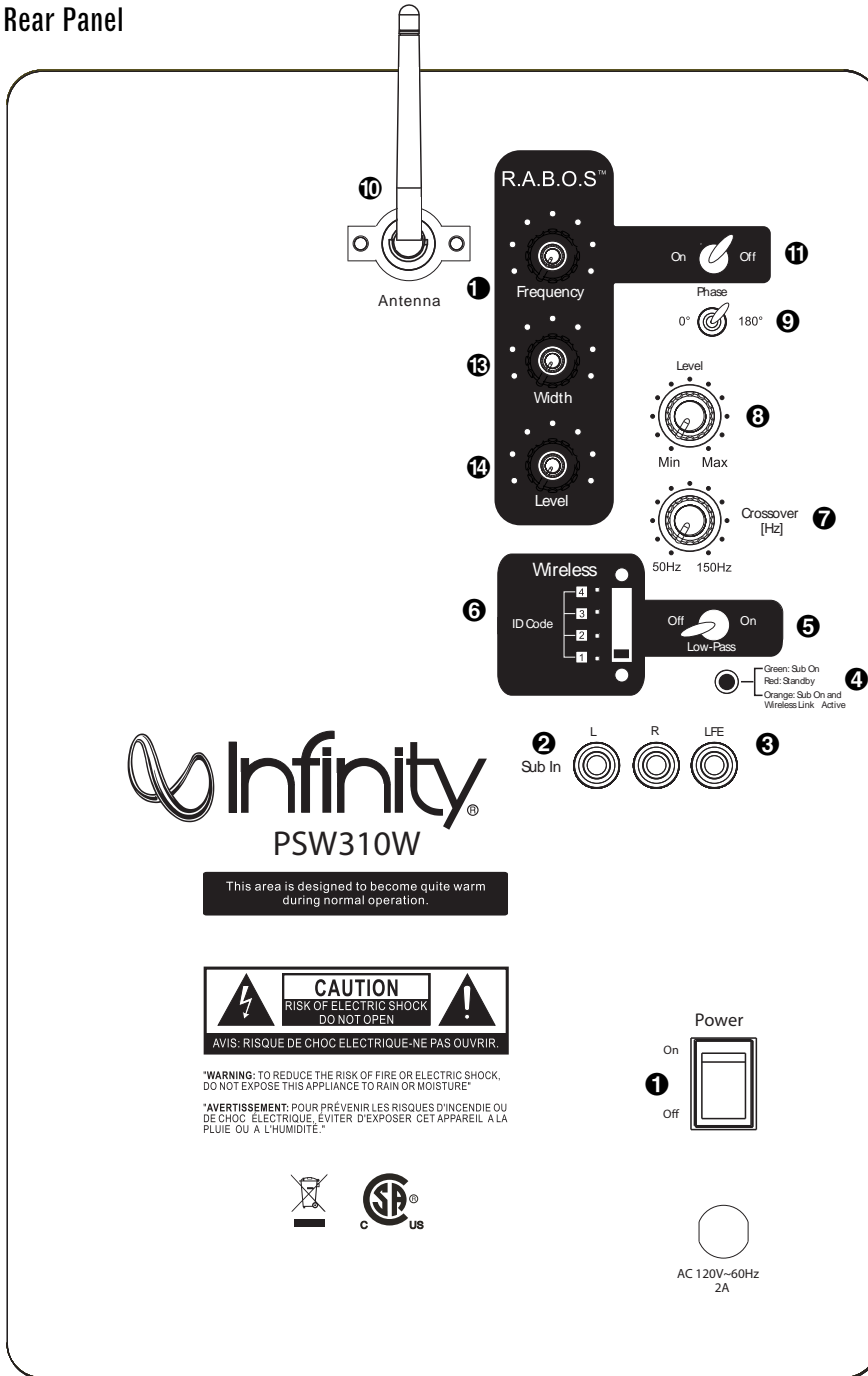

- 1 Power Switch
 - 2 Line-Level Inputs
 - 3 LFE Input
 - 4 Power Indicator LED
 - 5 Low-Pass Selector
 - 6 ID-Code Selector
 - 7 Crossover Adjustment Control
 - 8 Subwoofer-Level (Volume) Control
 - 9 Phase Switch
 - 10 Wireless Antenna
- Room Adaptive Bass Optimization Controls (see page 5)**
- 11 R.A.B.O.S. Selector
 - 1 R.A.B.O.S. Center-Frequency Adjustment
 - 13 R.A.B.O.S. Bandwidth Adjustment
 - 14 R.A.B.O.S. Level Adjustment
- Transmitter**
- 15 Transmitter Antenna
 - 16 Transmitter Power-Supply Input
 - 17 Transmitter ID-Code Selector
 - 18 Transmitter Sub Input

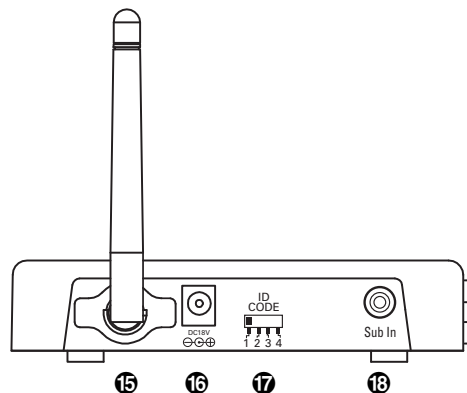

SYSTEM CONNECTIONS

Choose either Wireless or Wired connection, then follow the appropriate instructions.

WIRELESS

Connecting the Subwoofer for Wireless Applications

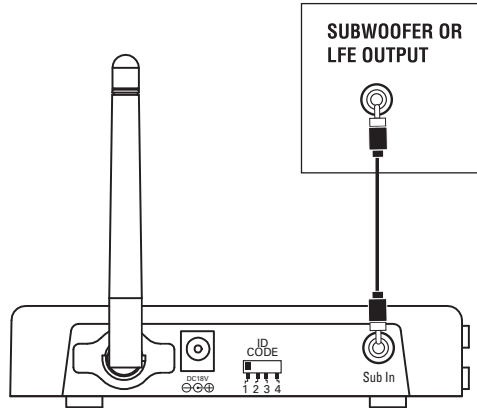

Step 1.

Connect a subwoofer cable from the subwoofer or LFE output of your receiver to the Sub In 13 on the transmitter.

Step 2.

Plug the transmitter module into the wall outlet, and connect the included power supply and power cord to the transmitter 16. Make sure the Transmitter Antenna 15 is extended upward.

Step 3.

Set the ID code on the transmitter and subwoofer (17 and 6) to the same position, as described on page 4. When connected properly, the LED 4 on the rear of the subwoofer will be orange.

Step 4.

Set the Low-Pass Selector 5 to the "Off" position.

NOTE: Some receivers have two subwoofer outputs. In that case, use either one of the connectors.

WIRED

Connecting the Subwoofer for Wired Applications

If you have a Dolby® Digital or DTS® receiver/processor with a low-frequency effects (LFE) or subwoofer output:

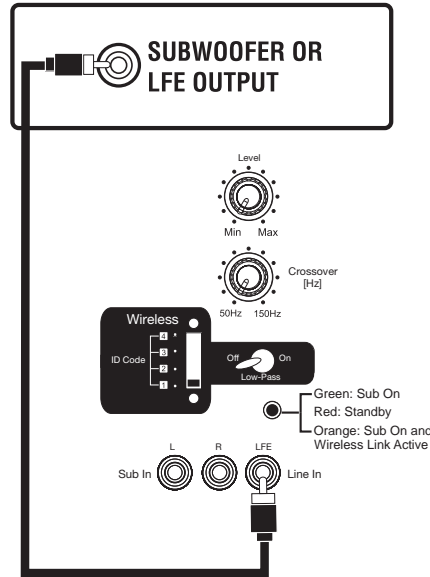

If your receiver/processor does not contain a Dolby Digital or DTS processor but has subwoofer outputs:

RECEIVER/PROCESSOR

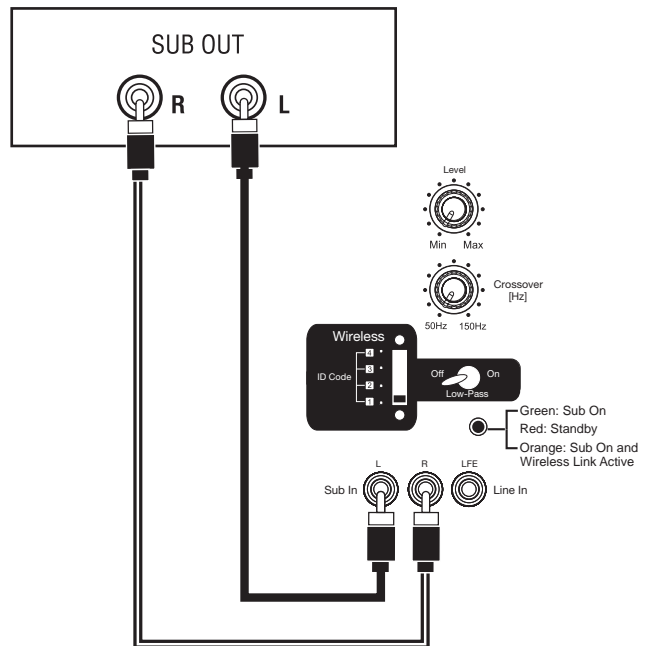

NOTE: If your receiver/processor has only one sub out, you may use either the L or R input.

OPERATION

Power On

Connect your signal source (such as an A/V receiver or preamplifier) to the transmitter (if using wireless connection) or to the subwoofer (if using wired connection). Two single-RCA cords are provided. While you would ordinarily use the short cable to connect to the transmitter or the long one to connect to the subwoofer, either cable can be used, depending on proximity to the signal source. There is no need or benefit gained from connecting the same source to both the transmitter and the subwoofer. However, you could connect two separate sources to this subwoofer by utilizing both its wired and wireless connections. Both signals will essentially be mixed and outputted by the subwoofer. Plug your transmitter's (if using wireless connection) and subwoofer's AC cord into a wall outlet. Do not use the outlets on the back of the receiver for the subwoofer.

Initially set the Subwoofer-Level Control **8** to the "Min" position. Turn on your sub by pressing the Power Switch **1** on the rear panel. Turn on your entire audio system and start a CD or movie soundtrack at a moderate level.

Auto On/Standby

Transmitter (wireless connection only): The Power Indicator LED (not shown) will be lit in red when the unit is in standby. When the transmitter receives an audio signal from the source, it will immediately turn on and the LED will turn to blinking green or solid green:

RED = STANDBY (No signal detected, transmitter off)

GREEN (BLINKING) = Transmitter is on but has not established a link with the wireless sub.

GREEN (SOLID) = Transmitter is on and has already established a link with the wireless sub.

The transmitter will automatically enter Standby mode after approximately 10 minutes when no signal is detected from your system.

Subwoofer: With the Power Switch **1** in the "On" position, the Power Indicator LED **4** on the back panel will remain lit to indicate the On/Standby mode of the subwoofer.

RED = STANDBY (No signal detected, amp off)

GREEN = SUB ON (Wired signal detected, amp on)

ORANGE = SUB ON (Wireless link with transmitter active)

The subwoofer will automatically enter Standby mode after approximately 10 minutes when no signal is detected from your system. The subwoofer will then power on instantly when a signal is detected. During periods of normal use, the Power Switch **1** can be left on. You may turn off the Power Switch **1** for extended periods of nonoperation, e.g., when you are away on vacation.

Getting Started

Confirm that the Status LED on the transmitter (not shown) is on (red or green) and the Status (Power Indicator) LED **4** on the subwoofer is on (red, orange or green) and that an RCA cable is connected from a source unit to either the LFE Input **3** of the subwoofer or transmitter **13** or L and R inputs **2** on the subwoofer. Play a CD or video. Use a selection that has ample bass information. If using a wireless connection, the Status LED on the transmitter should be lit in solid green, and the Status LED **4** on the subwoofer should turn orange if connected wirelessly. If the LED on the transmitter is blinking in green and the LED on the subwoofer is in red or green, a wireless link has not been established between the transmitter and the subwoofer. If connecting directly to the subwoofer without using the wireless link, the Status LED **4** on the subwoofer should be lit green. If the LED on the subwoofer remains red, check that the RCA cable from the source to the subwoofer (wired connection) or transmitter (wireless connection) is functioning properly (wired connection) and that it is fully inserted at both ends, or that the Transmitter ID-Code Selector **17** and the Subwoofer ID-Code Selector **6** are set to the same channel.

Once you have a green or orange LED on the subwoofer, turn your Subwoofer-Level Control **8** up halfway so that the knob indicator points up. You should now be hearing bass information coming from the subwoofer.

Adjust Level

Set the overall volume control of the preamplifier or stereo to a comfortable level. Adjust the Subwoofer-Level Control **8** until you obtain a pleasing blend of bass. Bass response should not overpower the room but rather be adjusted so there is a harmonious blend across the entire musical range. Many users have a tendency to set the subwoofer volume too loud, adhering to the belief that a subwoofer is there to produce lots of bass. This is not entirely true. A subwoofer should enhance bass, extending the response of the entire system so the bass can be felt as well as heard. However, overall balance must be maintained or the music will not sound natural. An experienced listener will set the volume of the subwoofer so its impact on bass response is always there but is never obtrusive.

Phase Control

The Phase Switch **9** determines whether the subwoofer driver's piston-like action moves in and out with the main speakers, 0°, or opposite the main speakers, 180°. Proper phase adjustment depends on several variables such as room size, subwoofer placement and listener position. Adjust the Phase Switch **9** to maximize bass output at the listening position.

Crossover Adjustment

The Crossover Adjustment Control **7** determines the highest frequency at which the subwoofer reproduces sounds. If your main speakers can comfortably reproduce some low-frequency sounds, set this control to a lower frequency setting, between 50Hz and 100Hz. This will concentrate the subwoofer's efforts on the ultradeep bass sounds required by today's films and music. If you are using smaller bookshelf speakers that do not extend to the lower bass frequencies, set the Crossover Adjustment Control **7** to a higher setting, between 120Hz and 150Hz.

NOTE: This control will have no effect if the LFE Input **3** is used (wired connection) or if the Low-Pass Selector **5** is in the "OFF" position (wireless connection). If you have a Dolby Digital or DTS processor/receiver, the low-pass frequency is set by the processor/receiver. Consult your owner's manual to learn how to view or change this setting.

ID Codes

In the unlikely event that you experience interference when operating the system, or if you have more than one set of subwoofer transmitters and receivers in operation, you may change the channel in which the system operates. On the transmitter module and the subwoofer, there is a four-position ID-Code Selector (**17** and **6**). Simply set the selectors to one of the other positions. The transmitter and subwoofer (**17** and **6**) selectors must be set to the same position for the system to function correctly. You can also set up a maximum of two subwoofers to be receiving from the same transmitter by setting the channel selector on the transmitter and both of the subwoofers to the same channel.

A Word About Wireless Products

The Infinity Classia PSW310W wireless subwoofer utilizes advanced wireless transceivers operating in the 2.4GHz frequency band. This is the same frequency band that is used for wireless home networks and high-quality cordless phones. It also allows for the transmission of high-performance, full-spectrum sound to remote locations, wirelessly.

Like all wireless devices, the Infinity PSW310W wireless subwoofer's operating range may vary, depending upon variables such as building construction methods and materials, atmospheric conditions and other sources of interference. Please consult your Infinity dealer or distributor, or visit www.infinitysystems.com, for further information or assistance.

Wall-Mounting the Transmitter Module

NOTE: The customer is responsible for the correct selection and use of mounting hardware (available through hardware stores) that will ensure the proper and safe wall-mounting of the transmitter.

Step 1.

Insert the two M3 x 4 machine screws through the wall bracket and into the rear of the transmitter module, as shown in the figure below.

Step 2.

Attach the transmitter module with wall bracket to the wall, using suitable hardware and, if necessary, wall anchors.

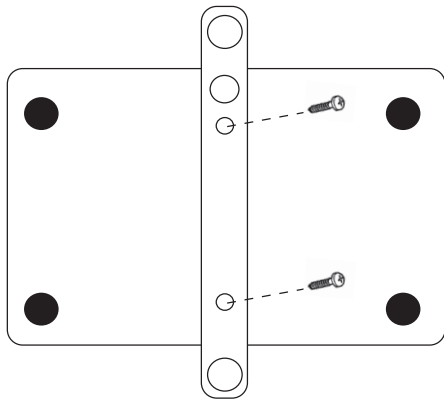

ROOM ADAPTIVE BASS OPTIMIZATION SYSTEM™

The Infinity R.A.B.O.S.™ technology is a simple-to-use, yet sophisticated, low-frequency calibration system. It is designed to work in conjunction with the Infinity Classia PSW310W powered sub. The subwoofer contains a parametric equalizer that you will adjust as indicated by the R.A.B.O.S. test results. By following these instructions, you will optimize the subwoofer's response characteristics to complement the sub's environment. This will dramatically improve the sound of your system. The optimization process takes less than 30 minutes.

The Optional R.A.B.O.S. Kit Includes the Following Components:

- Specialized Sound-Level Meter
- Test CD
- Instructions
- Measurement Templates
- Width Selector
- Adjustment "Key"

What R.A.B.O.S. Technology Does

The Test CD provides specially designed signals you will use while performing measurements. The sound-level meter provided is used to "acquire" the information needed for adjustments. You will create a response plot on the R.A.B.O.S. Measurement Template. Using the Width Selector, you will then determine the appropriate equalizer settings. The Adjustment "Key" is used to adjust the parametric equalizer built into the PSW310W. After adjustment, the test sequence is repeated to confirm your settings.

The R.A.B.O.S. Goal

It is a fact of audio that what we hear at low frequencies is determined as much or more by the listening room than by the loudspeaker itself. Placement of the loudspeakers and listeners and the acoustical characteristics of the room surfaces are all important determinants of bass quantity and quality. In most practical situations, there is little that can be done about this, except for patient trial-and-error repositioning of the loudspeakers and listeners. Usually, the practical constraints of a living space and the impracticality of massive acoustical treatment mean that equalization is the only practical solution.

Professional sound engineers routinely employ sophisticated measurement systems and equalizers to optimize speakers to the installation. This has never been practical for the home audiophile. This is why R.A.B.O.S. technology was created. It enables you to identify the dominant low-frequency response characteristic of your room. Once you know the problem, the R.A.B.O.S. system provides the tools needed to optimize the low-frequency characteristics of the speakers to the room they are in, exactly as the professional sound engineers do it.

Performing R.A.B.O.S. Tests

These instructions assume you have already installed your subwoofer according to the information provided in the owner's guide. It is also assumed that all equipment in your entertainment system is interconnected properly and is in good operating condition.

Preparations

Before beginning R.A.B.O.S. tests, please check the following:

- Set R.A.B.O.S. System Selector **11** to the "On" position.
- Make sure all three R.A.B.O.S. controls (**12**, **13** and **14**) on the subwoofer are turned fully clockwise.
- Make sure the loudness contour (if any) on your receiver/processor/preamp is turned off.
- Set the tone controls (Bass and Treble) to their center or flat positions.
- Bypass all surround and effects features of your receiver/processor/preamp or set to "Stereo Bypass."
- If you are using a multichannel surround processor or receiver, make sure all bass-management features are properly set. The Audio channels should all be set to "Small" or "High-Pass" and the subwoofer set to "On."

You must have a CD player in the system. A CD player remote control is quite convenient but not essential.

For best results, it is recommended that all major furnishings are in place and that all doors and windows in the listening area are in their normal positions. That is, if you normally listen to music with all doors closed, then this is how they should be during this procedure.

Try to minimize ambient noise while running tests. Turn off all major appliances and any air conditioning or furnace fans. These can create significant subsonic noise that may be barely perceptible but which can wreak havoc on low-frequency measurements.

Critical information is highlighted with this mark: **1**

Helpful hints are marked with this symbol: **→**

Contents of the R.A.B.O.S. Test CD

Track	Title	Track	Title
1	Welcome	32	Quick Retest 80Hz
2	Set System Test Level	33	Quick Retest 77Hz
3	Set Subwoofer Test Level	34	Quick Retest 72Hz
4	100Hz Test	35	Quick Retest 66Hz
5	95Hz Test	36	Quick Retest 63Hz
6	90Hz Test	37	Quick Retest 56Hz
7	85Hz Test	38	Quick Retest 52Hz
8	80Hz Test	39	Quick Retest 49Hz
9	77Hz Test	40	Quick Retest 46Hz
10	72Hz Test	41	Quick Retest 43Hz
11	66Hz Test	42	Quick Retest 40Hz
12	63Hz Test	43	Quick Retest 38Hz
13	56Hz Test	44	Quick Retest 35Hz
14	52Hz Test	45	Quick Retest 30Hz
15	49Hz Test	46	Quick Retest 26Hz
16	46Hz Test	47	Quick Retest 24Hz
17	43Hz Test	48	Quick Retest 22Hz
18	40Hz Test	49	Quick Retest 21Hz
19	38Hz Test	50	Quick Retest 20Hz
20	35Hz Test	51	Final System-Level Adjustment
21	30Hz Test	52	Final Subwoofer-Level Adjustment
22	26Hz Test	53	Wide Band Pink Noise, Left
23	24Hz Test	54	Wide Band Pink Noise, L+R
24	22Hz Test	55	Wide Band Pink Noise, Right
25	21Hz Test	56	Wide Band Pink Noise, L-R
26	20Hz Test	57	Wide Band Pink Noise, Uncorrelated
27	Intro to Quick Retest	58	1 to 4kHz Pink Noise, Left
28	Quick Retest 100Hz	59	1 to 4kHz Pink Noise, L+R
29	Quick Retest 95Hz	60	1 to 4kHz Pink Noise, Right
30	Quick Retest 90Hz	61	1 to 4kHz Pink Noise, Left-R
31	Quick Retest 85Hz	62	1 to 4kHz Pink Noise, Uncorrelated

Tracks 53–62 of the R.A.B.O.S. Test CD are test tones that can be used for general diagnostics of your system. They are not used for R.A.B.O.S. settings.

THE R.A.B.O.S. SOUND-LEVEL METER (RSLM)

The RSLM is a battery-operated, handheld, acoustic measurement device specifically designed for the Infinity R.A.B.O.S. system. On the face of the instrument is a light-emitting diode (LED) bar graph that indicates relative sound level. There are also indicators for power-on, out-of-range signals and a low battery.

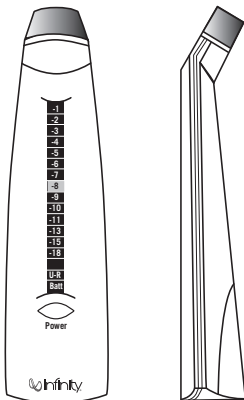

Figure 2. R.A.B.O.S. Sound-Level Meter

Power is switched on or off by pressing the button directly below the bar-graph window. When the unit is on, one or more LEDs will always be illuminated. The function of the LEDs is described in the following section.

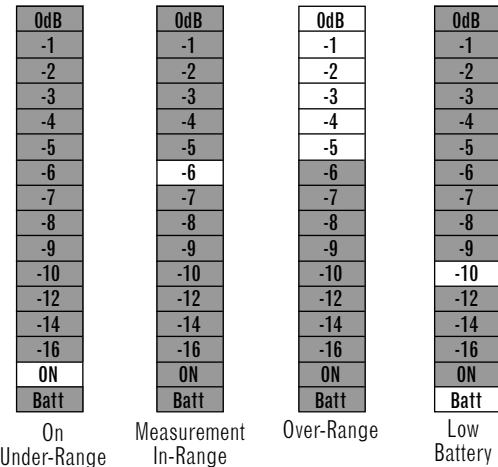

Figure 3. RSLM bar-graph indications

- **Power-On/Low Signal:** This is indicated by the illumination of any LED on the bar graph. If the sound level in the room is below the measurement range of the instrument, a green LED near the bottom of the bar graph will be illuminated.
- **Normal Measurements:** When the sound level is within the range of the RSLM, the green LED will be off and one of the red LEDs in the bar graph will be illuminated, indicating the relative sound level, in decibels (dB).
- **Over-Range:** If the sound level exceeds the range of the meter, 0dB through -5dB will all light simultaneously.
- **Low Battery:** When the battery voltage is too low for accurate measurements, an LED at the bottom of the bar graph will be illuminated. Replace the battery.

ⓘ Do not attempt measurements when the Low Battery light is on.

RSLM Placement

Determine where in the room you are most likely to sit when listening to music or watching a movie. This is where you will want to hold the RSLM during measurements. The RSLM should be oriented so it can be easily read and held at your seated ear level during tests.

ⓘ You must use this same position for all tests.

🔧 The RSLM can be mounted on a standard camera tripod. This will ensure the best results.

Initial System-Level Setting

The following steps will set the playback level of the system to the correct level for all tests that follow.

- ① Turn the system volume to minimum.

Cue the R.A.B.O.S. Test CD to Track 2 and press **Pause II**. This track will produce band-limited pink noise in both the left and right channels.

Press **Play ▶**. With the RSLM positioned as described above, increase the system volume until the RSLM display indicates -10dB . See Figure 4.

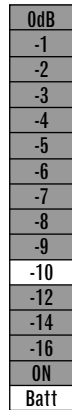

Figure 4. RSLM indicating the correct system level to begin tests (-10dB)

When you have completed this adjustment, press **Pause II**.

Setting the Subwoofer Test Level

ⓘ Each of the following test tracks is about one minute long. This is normally much longer than required. Press **Pause II** or advance to the next test as soon as you are ready.

This step will set the subwoofer levels for measurement purposes. The objective is to scale the subwoofer's output to make full use of the RSLM indicator range. Scaling is optimum when a 0dB reading is observed on the highest peak without triggering the over-range indication. Later, you will rebalance the subwoofer to the main speakers.

① The three R.A.B.O.S. controls, ①, ⑬ and ⑭, should be set to fully clockwise positions, and all measurements should be conducted with their level controls in this position. Confirm this setting before you begin this test. The **Subwoofer-Level Control** ⑧ should be set to the mid position.

Cue Track 3 and **Pause II**. Track 3 continuously steps through all subwoofer test tones for approximately one minute. Each tone will play just long enough for the RSLM to give a stable reading.

ⓘ To get accurate measurements, it is necessary to play the subwoofer quite loud. The 0dB indication is about 94dB . At this level, frequencies below 100Hz can cause doors, windows, furnishings and other objects in the room to vibrate. This frequently results in clearly audible buzzes and/or rattles that come and go as each test tone plays. Strong buzzes not only

sound bad; they can cause measurement errors. If you hear a buzz or rattle during this test, it is highly recommended that you locate the source and eliminate its effects. This is actually a valuable room-diagnostic tool.

Press **Play ▶**. As Track 3 plays, watch the RSLM carefully. Watch for peak readings. The peak reading may be no more than a brief flash. Readjust the subwoofer's **Subwoofer-Level Control** ⑧ until the peak level observed is 0dB without triggering the over-range indication. See Figure 5.

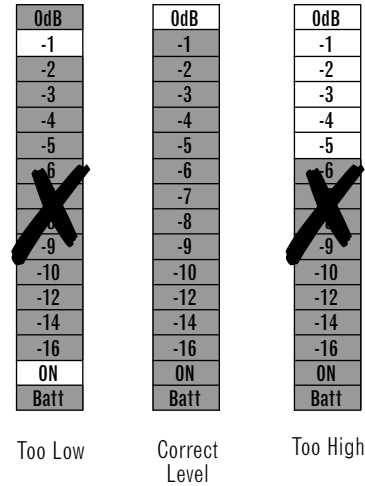

Figure 5. Adjusting the subwoofer levels for a 0dB peak

When finished, press **Pause II**.

Performing Low-Frequency Measurements

ⓘ Read the following instructions fully before beginning tests.

For the following steps, you will need a R.A.B.O.S. Measurement Template and a pencil.

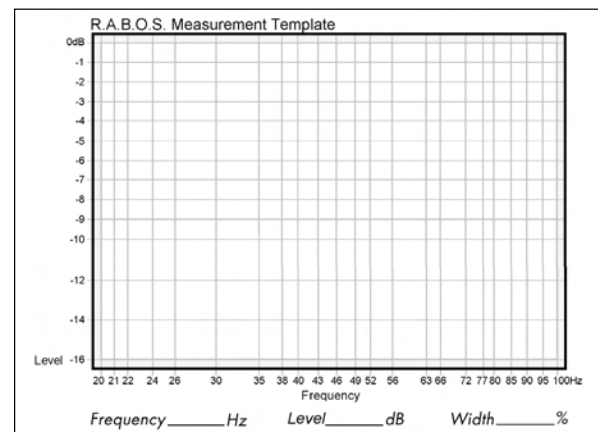

Figure 6. R.A.B.O.S. Measurement Template

Each of the following tracks produces a low-frequency test tone. The range of these tests is from 100Hz down to 20Hz. The frequency of each test is announced before it begins. The first test is the highest frequency (100Hz); therefore, you will be marking the template from right to left. Each frequency point is listed across the bottom of the R.A.B.O.S. Measurement Template (this is called the X-axis). See Figure 6 on the previous page. The vertical scale on the left side of the template indicates relative level, in dBs (the Y-axis). The template's vertical scale matches that of the RSLM bar graph.

Cue Track 4 and **Pause II**.

🔊➡ From now on, you will want to keep your CD player's remote control handy.

Press **Play ▶**. As Track 4 plays, observe the level indicated on the RSLM.

EXAMPLE: The test frequency is 100Hz and the level indicated is -2dB. Find the intersection of 100Hz (X-axis) and -2dB (Y-axis). Place a dot at that point. See Figure 7.

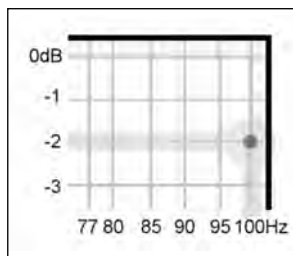

Figure 7. Locating a test point

🔊➡ It takes a few seconds for the RSLM reading to stabilize, especially at very low frequencies. Don't rush. Give each test adequate time for the meter to stabilize.

At the bottom of the bar graph is a green "On" LED. This LED is illuminated whenever the sound level is below the measuring range of the RSLM. If this occurs during a test, place a dot at the intersection of the test frequency and the bottom frame of the template. See Figure 8.

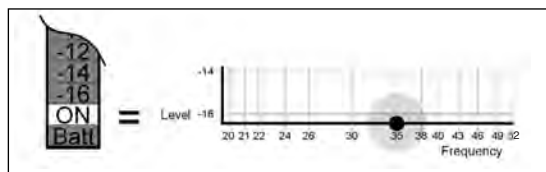

Figure 8. Indicating an under-range test

When finished, press **Skip ▶▶** to advance to the next test. Repeat the process described above for Tracks 5 through 26.

When you have completed the 23 measurements, you are ready to analyze the data and make corrective adjustments. The completed R.A.B.O.S. Measurement Template will look something like the example in Figure 9.

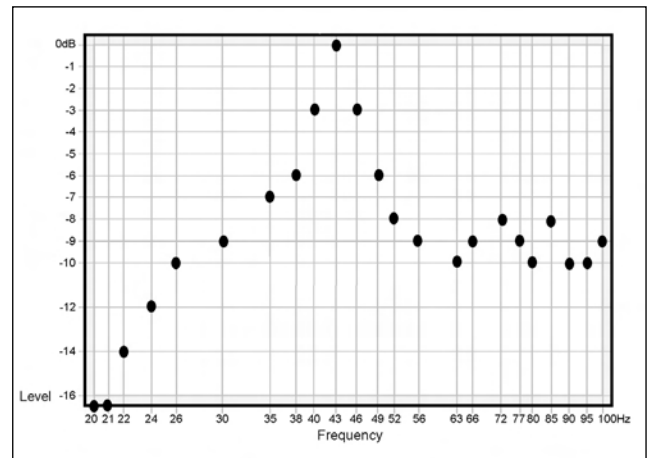

Figure 9. Completed R.A.B.O.S. template

Now connect the dots as shown in Figure 10. This will make interpretation of the data much easier.

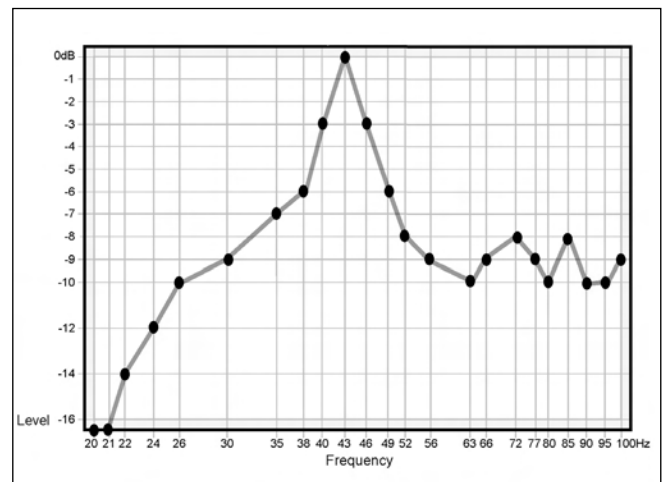

Figure 10. Test example with dots connected



At this point, you may simply enter the data you just measured into the R.A.B.O.S. calculator, found on the Infinity Web site at www.infinitysystems.com. After entering the data, this R.A.B.O.S. wizard will return the correct settings for all three R.A.B.O.S. controls: ❶, ❷ and ❸. Skip to page 14 and adjust these controls as described, and finish the R.A.B.O.S. setup. If you would like to manually calculate the R.A.B.O.S. settings, simply continue following the instructions from this point.

What Does a Parametric Equalizer Do?

The R.A.B.O.S. system uses one band of parametric equalization for response correction. Parametric equalizers are the most versatile class of filters. The effect an equalizer will have on the signal is dependent on three parameters.

Frequency: The equalizer will have maximum effect at one frequency, usually described as the center frequency.

Level: This refers to the amount of cut (in dBs) for which the equalizer is set.

Bandwidth: Defines the range of frequencies over which the equalizer will have an effect. On the PSW310W, this adjustment is abbreviated as "Width."

Only parametric equalizers allow independent adjustment of all three parameters.

These will be explained more fully in the sections that follow.

Completing the R.A.B.O.S. Measurement Template

Along the bottom of the R.A.B.O.S. Measurement Template are three fields where you will enter the equalizer settings needed to complete system optimization.

These instructions are based on the example in Figure 11. Use this tutorial to become familiar with the process. Strategies for several other test results will be presented later. After you have completed these three entry fields, you will be ready to perform the adjustments, completing R.A.B.O.S. optimization.

Frequency

The frequency of the R.A.B.O.S. equalizer may be adjusted to any one of nineteen frequencies from 20Hz to 80Hz. This defines where you are going to apply equalization.

Width

The frequency range of the R.A.B.O.S. equalizer may be set from 5% to 50% of an octave in 21 steps. This setting defines how much of the PSW310W's output will be equalized.

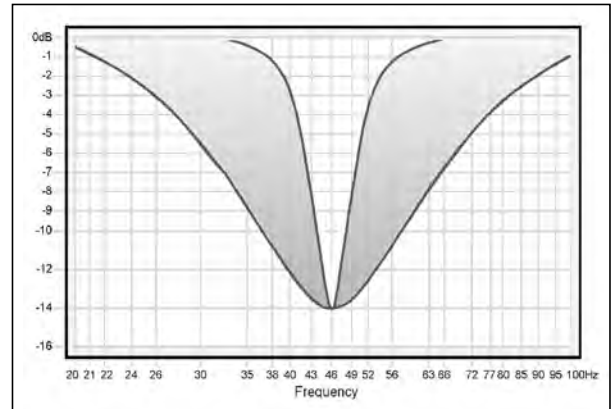

Figure 11. Effect of adjustable width

Width is expressed as a percentage of an octave. For example, a width setting of 25% means the equalizer will affect a frequency band of 1/4 of an octave; 1/8 of an octave above and 1/8 of an octave below the center frequency.

➔ The octave is a logarithmic expression. From any point in the spectrum, one octave above or below that point is always double or half the frequency. Therefore, one octave above 100Hz would be 200Hz. One octave below 100Hz is 50Hz.

In the section that follows, we will discuss the use of the Width Selector.

Using the Width Selector

① Read the following instructions carefully. The example presented may not look like the graph you just created. Focus on the concepts and techniques presented. Specific cases will be discussed later.

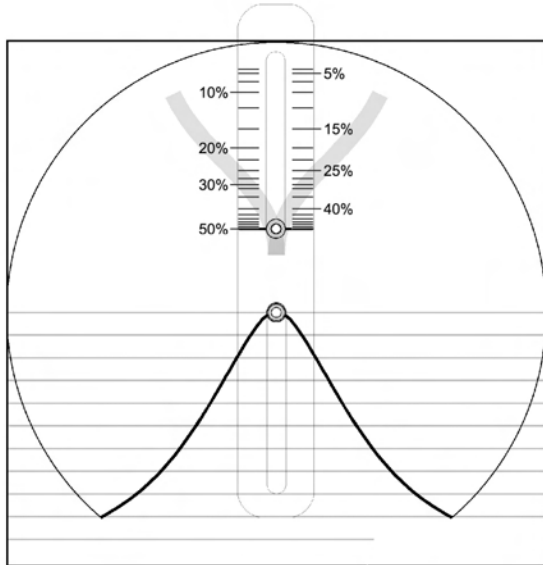

Figure 12. Width Selector

You will use the R.A.B.O.S. Measurement Template just completed and the Width Selector to determine the correct width setting. The Width Selector graphically depicts a single resonant peak. The peak looks similar to a slice of a pie. See Figure 12. At the top of the Selector is a pull tab. When you slide the tab up and down, the width of the pie slice becomes narrower and wider, respectively. The pointers on the sides of the button point to the bandwidth that corresponds to the width of the slice.

Place the Width Selector over the R.A.B.O.S. Measurement Template, positioning the center rivet of the Selector over the response peak, as shown in Figure 13. Be sure to align the horizontal lines of the Width Selector with those of the R.A.B.O.S. Measurement Template.

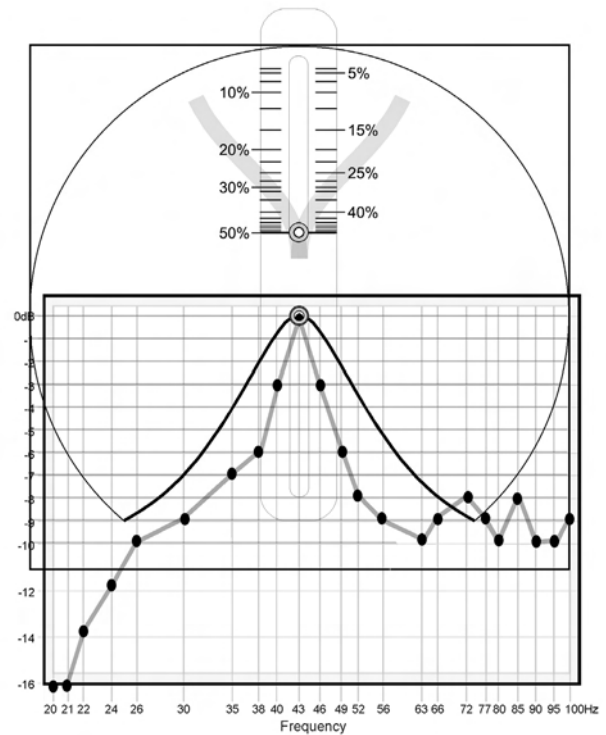

Figure 13. Placement of the Bandwidth Selector

Apply pressure to the upper and lower left corners of the Width Selector using the thumb and forefinger of your left hand. Now gently slide the tab up or down until the adjustable slice most closely fits the response data. See Figure 14.

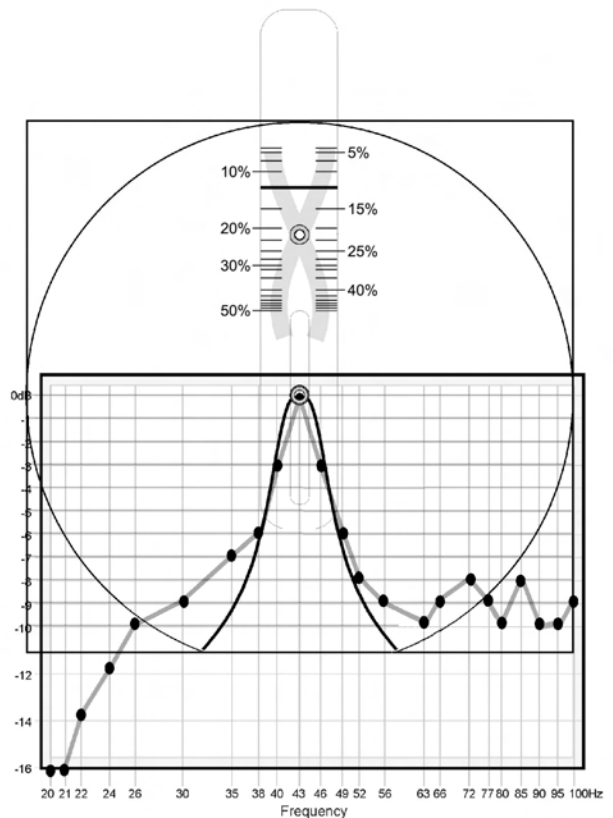

Figure 14. Selector adjusted for the "best fit"

The pointer on the slider will indicate the correct width setting. Enter this number in the Width field of the R.A.B.O.S. Measurement Template. In our example, the width is 12.5%.

☞ It is not realistic to expect a perfect fit. Acoustic measurements encompass the behavior of not only the speakers but of the room and its contents as well. Reflected energy, standing waves and ambient noise all add their part. Determining the best width setting nearly always requires compromise.

Level

This setting will define the amount (level) you want to reduce the peak, in decibels.

The R.A.B.O.S. level adjustment is limited to attenuation only, and is adjustable from 0dB to -14dB. After optimization, the R.A.B.O.S. equalizer will eliminate the largest low-frequency peak; therefore, the broadband bass level can be increased without overpowering the midrange frequencies. The R.A.B.O.S. system applies this compensation automatically.

You will use the Width Selector as an aid in determining the correct level setting. Place the Width Selector as described above and adjust it to the correct width. Observe the first frequency point on the high-frequency side of the peak that no longer follows the slope of the Width Selector. In this example, this is 56Hz. Calculate the average level of the readings from 56Hz up to 100Hz; that is, 10 data points in this example.

56Hz	63Hz	66Hz	72Hz	77Hz	80Hz	85Hz	90Hz	95Hz	100Hz
-9	-10	-8	-9	-10	-9	-8	-10	-10	-9

$-9 + 10 = -9.2$

Whenever your answer has a remainder, always round down (disregarding the negative [-]) to the next whole number.

In our example, you would enter 9 in the attenuation field.

This may not be the best method in all cases. The next section contains several other examples.

What You Measure, What to Do

As stated earlier, it is not possible to anticipate the effect of every possible listening environment. However, most residential sound rooms share many characteristics, and their dimensions fall into a range that make some response irregularities far more likely than others. On the following pages are examples of what you may encounter. Following each example is a strategy for correction. Compare your measurement results with the following examples. Find the one that best fits your graph and follow the instructions presented for that scenario.

☞ Remember, when looking for a match, look at the descriptive characteristics, not any specific frequency or level. Each of these examples can occur at any frequency, bandwidth and level. It is unlikely that your test results will be exactly as depicted in these examples.

Example 1. Single Dominant Peak:

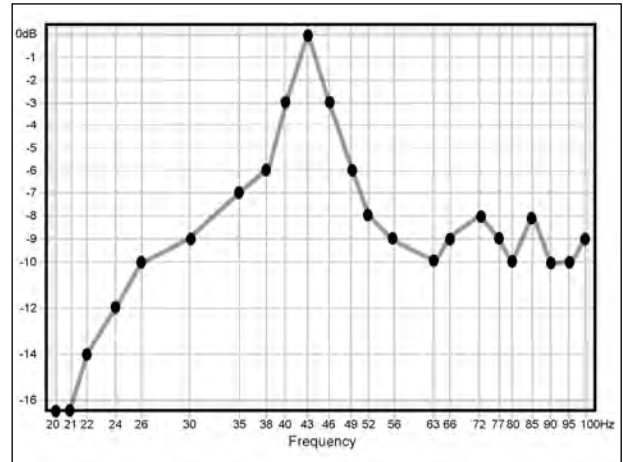

Figure 15. Single dominant peak

This is the most common result of speaker/room interaction.

Apply the Width Selector as described in Figure 13. Align the center-line of the Selector over the center of the peak, as shown in Figure 14. Now adjust the Selector until you have achieved the "best fit." The slider now points to the correct bandwidth setting. In this example, the frequency is 43Hz and the best-fit width is 12.5%. Fill in the Width and Frequency fields provided on the template.

Determine the appropriate level using the technique described earlier. In this example, -9dB would be best. Enter the level in the field provided.

Skip to the "Adjusting the R.A.B.O.S. Equalizer" section on page 14.

Example 2. Two Response Peaks:

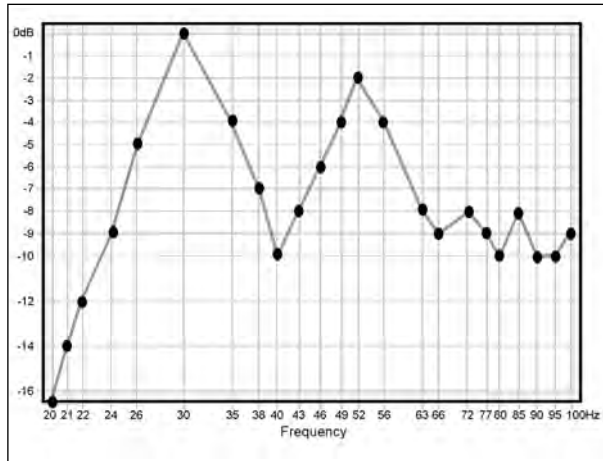

Figure 16. Two response peaks

Characterized by two response peaks, approximately equal in amplitude and width. This requires that you make a choice between the two peaks. In situations like this, the higher frequency peak will always be more audible and objectionable. Response peaks below 45Hz, unless extreme, can actually be beneficial toward achieving visceral impact. Perform corrections on the upper frequency peak.

Apply the Width Selector as described above. Align the center-line of the Selector over the center of the higher frequency peak. Now adjust the Selector until you have achieved the "best fit." The slider now points to the correct width setting. In this example, this is at 52Hz. The best-fit width is 28%. Fill in the Width and Frequency fields provided on the template.

Determine the appropriate level using the technique described earlier. This calculation will indicate a -8dB setting. However, this peak does not reach the 0dB level as the lower peak does. Therefore, a -8dB setting would be excessive. The 52Hz peak stops at -2dB . Subtracting 2 from 8 yields the correct setting, -6dB . Enter -6 in the Level field.

Skip to the "Adjusting the R.A.B.O.S. Equalizer" section on page 14.

Example 3. Peak Adjacent to a Dip:

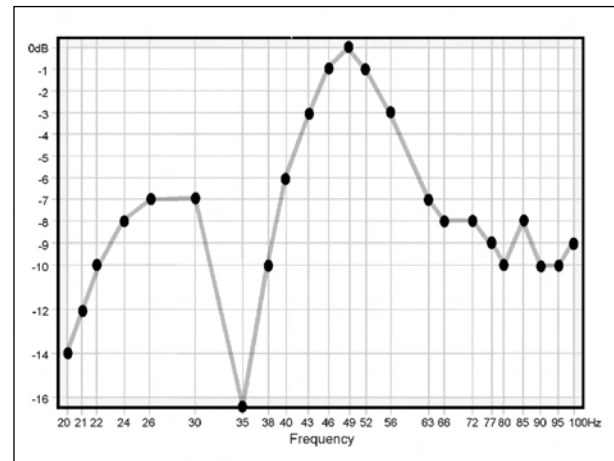
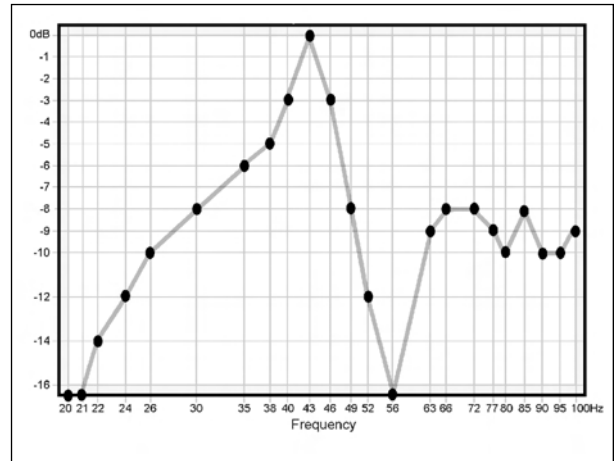

Figure 17. Dip above or below peak

Response dips can occur at any frequency, sometimes immediately adjacent to the peak you want to correct. Two examples are shown, one immediately above and one immediately below the peak. Deep response dips such as these are caused by destructive wave interference. Destructive interference dips occur only in one spot within the room. It is not uncommon to completely eliminate the effect by moving the RSLM to a different location. Note that this does not eliminate the dips; you have simply moved away from them. Sometimes only a few inches are required. Do not attempt to correct this condition with equalization. If you encounter dips like this, follow the steps on page 13:

1. Select a new test position: Cue the test track corresponding to the center frequency of the dip. In the first example in Figure 18, you would play Track 13 (56Hz). Press **Play ▶**. You will see a reading very close to what you had before. Now, slowly move the RSLM around the area, if possible remaining within about a foot of the original test point. As you move the RSLM, watch the bar graph. You will observe large level fluctuations. Find a position that restores the level to approximately that of the adjacent test points. You may find it helpful to move the RSLM vertically. Dips can be oriented in any axis. The position that restores the level to about that of the adjacent test points is your new test position.
2. Reset the test level: Return to the section "Setting the Subwoofer Test Level" on page 7. Perform the procedure as described.
3. Repeat the measurements: Now that you are familiar with the measurement process, you can go much faster by using Tracks 27–50. These tracks contain all the test tones necessary for measurement. However, each test is only about three seconds, and there is no frequency announcement. The first test is 100Hz. Just place each test mark in order until finished. Connect the dots.

Your second measurement will no longer exhibit the deep response dip. However, the peak will still be evident. Without the influence of the response dip, the amplitude and center of the peak may have changed. Compare your new data to the examples given in this section of the manual. Follow the instructions for the example that most closely matches your new measurement.

Example 4. Narrow Response:

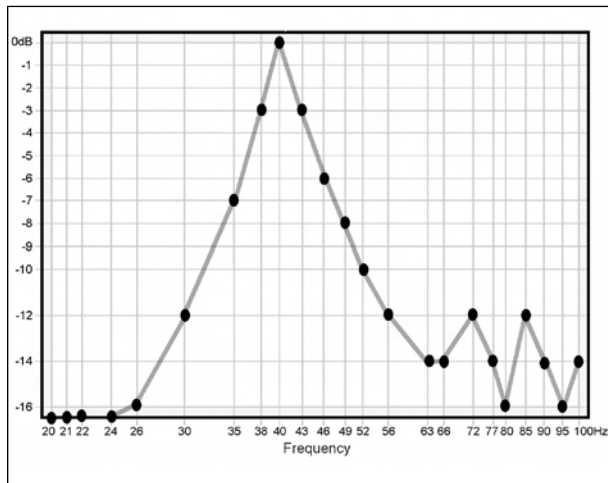

Figure 18. Narrow Response

Although it looks as though this system is quite bass-deficient, this is actually indicative of a single, very narrow peak in excess of 10dB high.

Apply the Width Selector as described above. Align the center-line of the Selector over the center of the peak, as shown in Figure 13. Now adjust the Selector until you have achieved the "best fit." The slider now points to the correct width setting. In this example, the frequency is 40Hz and the best-fit width is 10%. Fill in the Width and Frequency fields provided on the template.

Determine the appropriate level using the technique described earlier. In this example, -13dB is indicated. Enter 13 in the field provided.

Skip to the "Adjusting the R.A.B.O.S. Equalizer" section on page 14.

Example 5. One or More Narrow Dips:

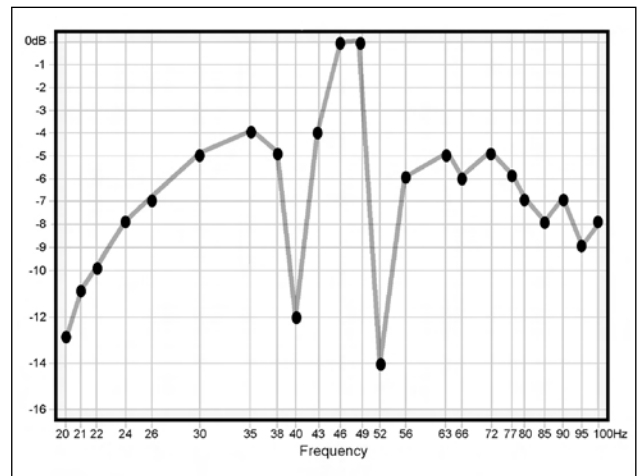

Figure 19. Example of two narrow dips

Response dips can occur at any frequency, sometimes immediately adjacent to the peak you want to correct. In this example, there are two such dips on either side of the peak. Deep response dips such as these are caused by destructive wave interference. Destructive interference dips occur only in one spot within the room. It is not uncommon to completely eliminate their effect by moving the RSLM to a different location. Note that this does not eliminate the dips; you have simply moved away from them. Sometimes only a few inches are required. Do not attempt to correct this condition with equalization. If you encounter dips like this, follow the steps on page 14:

1. Select a new test position: Cue the test track corresponding to the center frequency of the dip. In the example in Figure 19 you would play Tracks 14 (52Hz) and 18 (40Hz). Press **Play** ▶. You will see a reading very close to what you had before. Now, slowly move the RSLM around the area, if possible remaining within about a foot of the original test point. As you move the RSLM, watch the bar graph. You will observe large level fluctuations. Find a location for the subwoofer or a test location that raises the response at these frequencies. You may find it helpful to move the RSLM vertically. Dips can be oriented in any axis. The position that restores the level to about that of the adjacent test points is your new test position.
2. Reset the test level: Return to the section "Setting the Subwoofer Test Level" on page 7. Perform the procedure as described.
3. Repeat the measurements: Now that you are familiar with the measurement process, you can go much faster by using Tracks 27–50. These tracks contain all the test tones necessary for measurement. However, each test is only about three seconds, and there is no frequency announcement. The first test is 100Hz. Just place each test mark in order until finished. Connect the dots.

Your second measurement will no longer exhibit the deep response dips. However, the peak will still be evident. Without the influence of the response dips, the amplitude and center of the peak may have changed.

4. Interpret the new data: Compare your new data to the examples given in this section of the manual. Follow the instructions for the example that most closely matches your new measurement.

Example 6. Ideal Response:

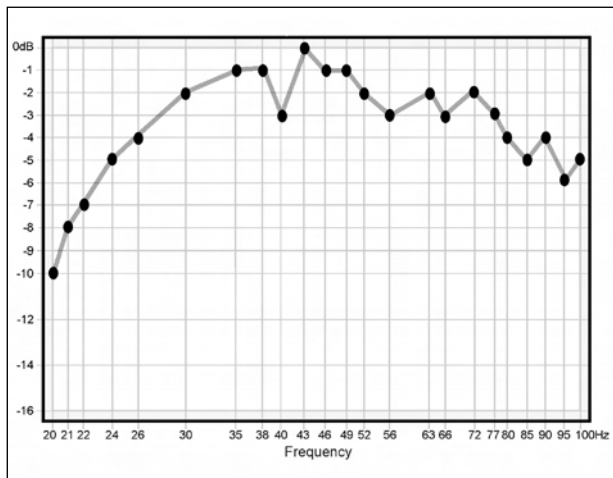

Figure 20. Ideal response, no EQ needed

If your test data looks similar to the example in Figure 21, you have a very favorable setup. Skip to the "Final System Balance" section, page 15.

Adjusting the R.A.B.O.S. Equalizer

Now that you have performed the measurements and interpreted the data, you have the information needed to adjust the subwoofer's equalizer.

There are three equalizer adjustments on the subwoofer. Left to right, they are marked Frequency, Level and Width. Each control has 21 positions. These are numbered from left to right. Therefore, Position 1 is the full counterclockwise position. The following table illustrates all switch positions.

Position	F (Hz)	L (dB)	W
1 CCW	20	-14.1	4.5%
2	20	-13.9	5%
3	20	-13.5	7.5%
4	21	-13.1	10%
5	22	-12.7	12.5%
6	24	-11.7	16.5%
7	26	-11.0	20.5%
8	30	-10.2	23%
9	35	-9.5	26%
10	38	-8.9	28%
11	40	-8.3	29.5%
12	43	-7.9	31%
13	46	-6.4	34%
14	49	-4.4	39%
15	52	-2.9	41.5%
16	56	-1.9	43.5%
17	63	-1.1	45%
18	66	-0.5	46.5%
19	72	0.0	48%
20	77	0.0	49%
21 CW80	0.0	49.5%	

If using more than one subwoofer, always adjust both subwoofers together. Adjust the controls as indicated by the Measurement Template. Each value shown in the table is represented by detents in the R.A.B.O.S. controls. Simply count the number of detents necessary, indicated by the results of your R.A.B.O.S. Test.

PSW310W R.A.B.O.S. Controls

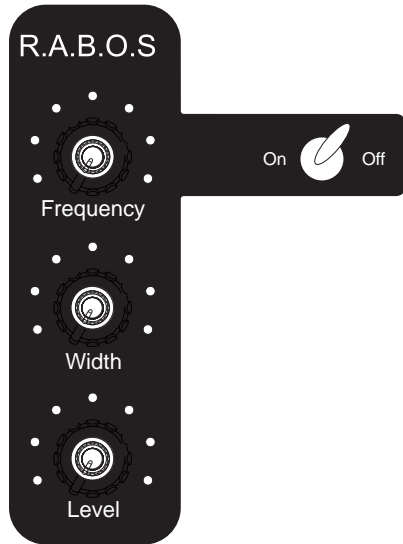

After performing these adjustments, you may skip forward to the “Final System Balance” section. It is recommended that you perform a second measurement to confirm that the settings are correct.

① If you are going to retest the system after EQ adjustments, repeat the “Setting the Subwoofer Test Level” section on page 7.

🔗 Retesting the system will go much faster if you use Tracks 27–50. These tracks contain all the same test tones you just used. However, each tone plays for only a few seconds and there is no frequency announcement. If you are uncomfortable operating at this pace, you may, of course, perform measurements with the original test tracks.

Your first interpretation of the data and choice of settings may not be optimum. You can repeat the test-adjust-test cycle as often as needed to get the desired results. To do this, return to page 7, “Setting the Subwoofer Test Level.” You may prefer to retest using the same template. Doing so makes it easy to evaluate the improvement.

When you are satisfied with the results, go to “Final System Balance.”

Final System Balance

Cue Track 51 of the R.A.B.O.S. Test CD. Press **Play** ▶. Increase the system volume until the RSLM indicates -10dB . Now play Track 52. Adjust the subwoofer gain control until -10dB is indicated on the RSLM. Of course, you may fine-tune the subwoofer gain control to your listening preference.

This concludes the R.A.B.O.S. process. It is recommended that you remove the battery from the RSLM. Store the Test CD, Width Selector, Adjustment Key and the RSLM together.

MAINTENANCE AND SERVICE

The enclosure and grille may be cleaned using a soft cloth to remove fingerprints or to wipe off dust.

All wiring connections should be inspected and cleaned or remade periodically. The frequency of maintenance depends on the metals involved in the connections, atmospheric conditions, and other factors, but once per year is the minimum.

If a problem occurs, make sure that all connections are properly made and clean. If a problem exists in one loudspeaker, reverse the connection wires to the left and right system. If the problem remains in the same speaker, then the fault is with the loudspeaker. If the problem appears in the opposite speaker, the cause is in another component or cable. In the event that your subwoofer ever needs service, contact your local Infinity dealer or distributor or visit www.infinitysystems.com for a service center near you.

IMPORTANT: Please attach your sales receipt to this manual and store in a safe place. In the event that your Infinity speaker requires warranty service, you'll need to provide your sales receipt.

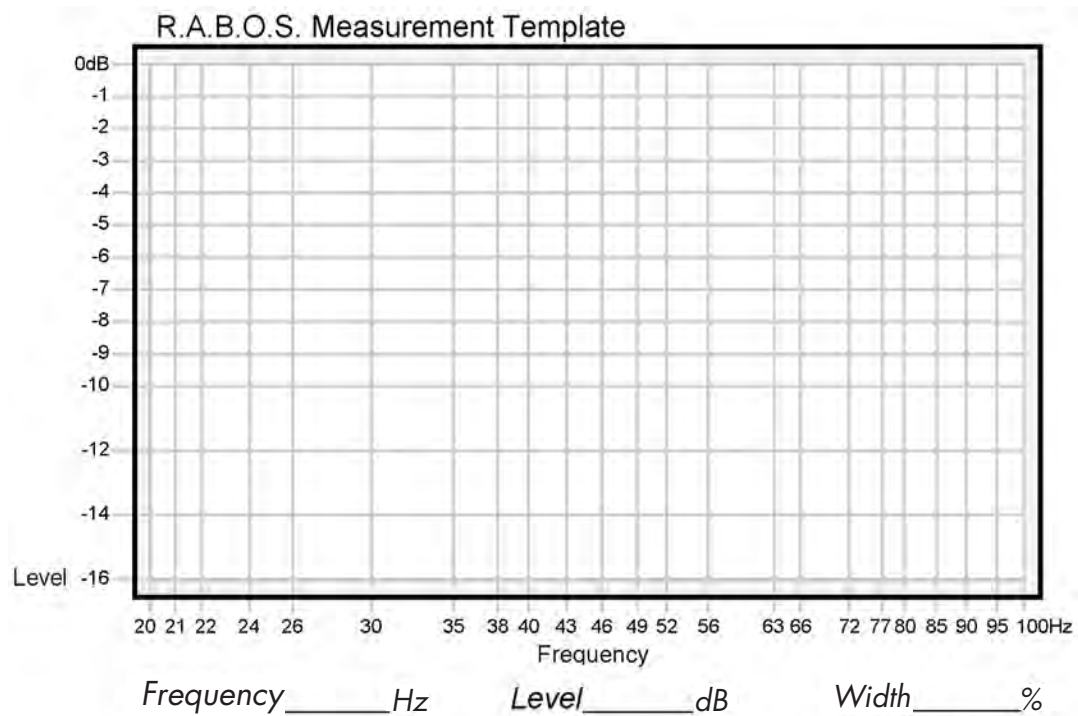
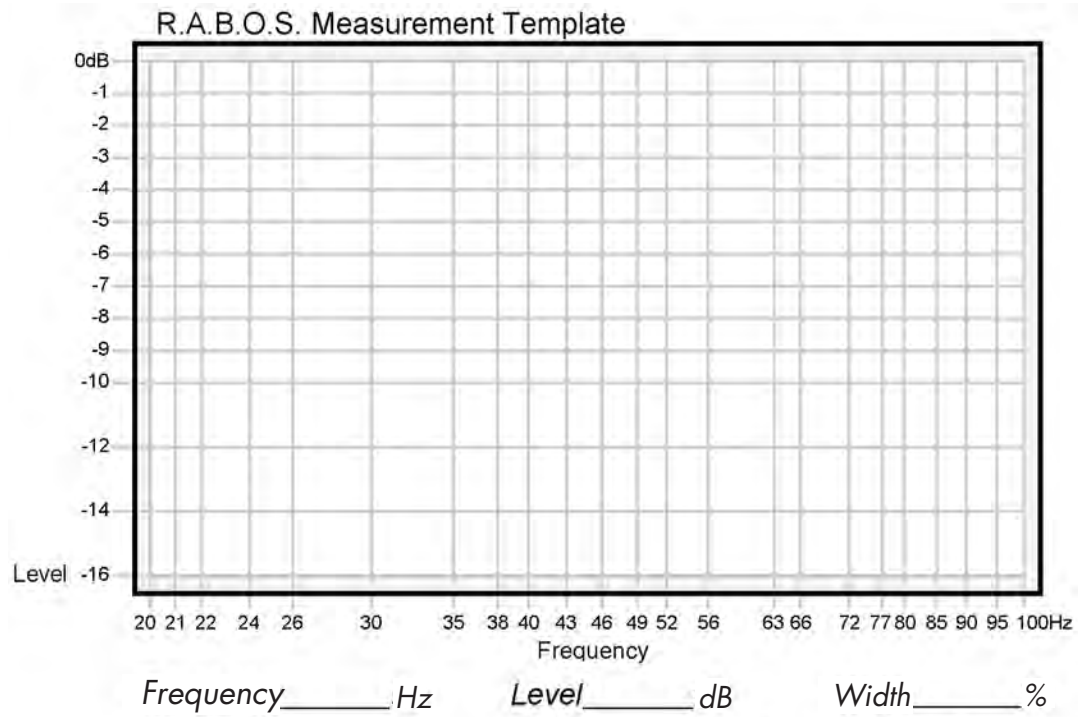

R.A.B.O.S. Measurement Template

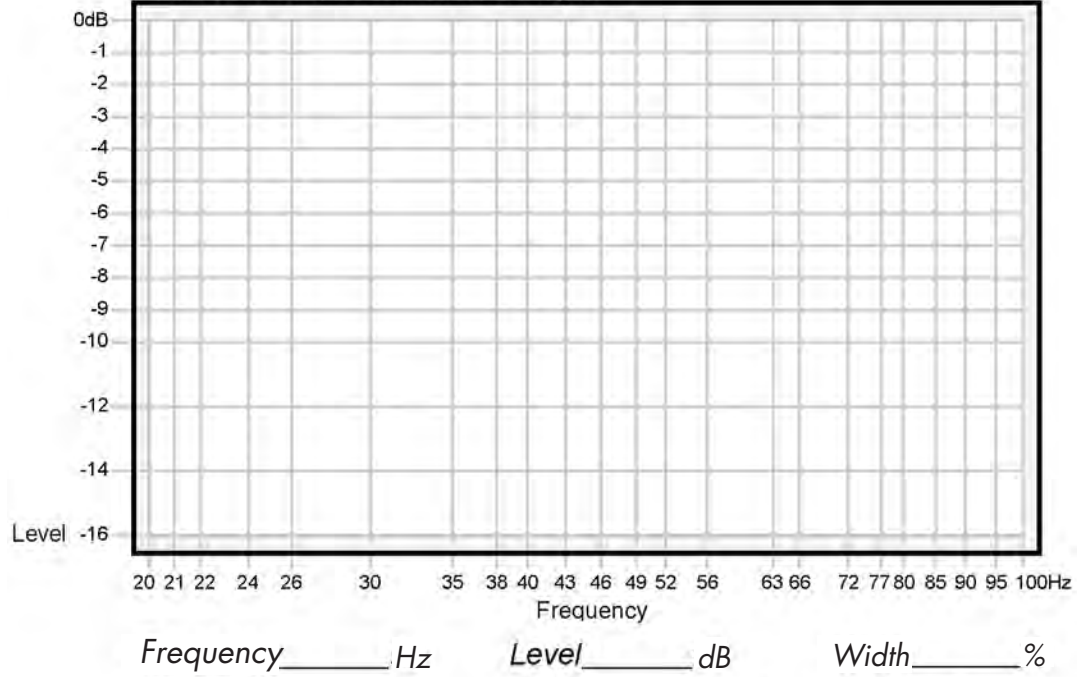

R.A.B.O.S. Measurement Template

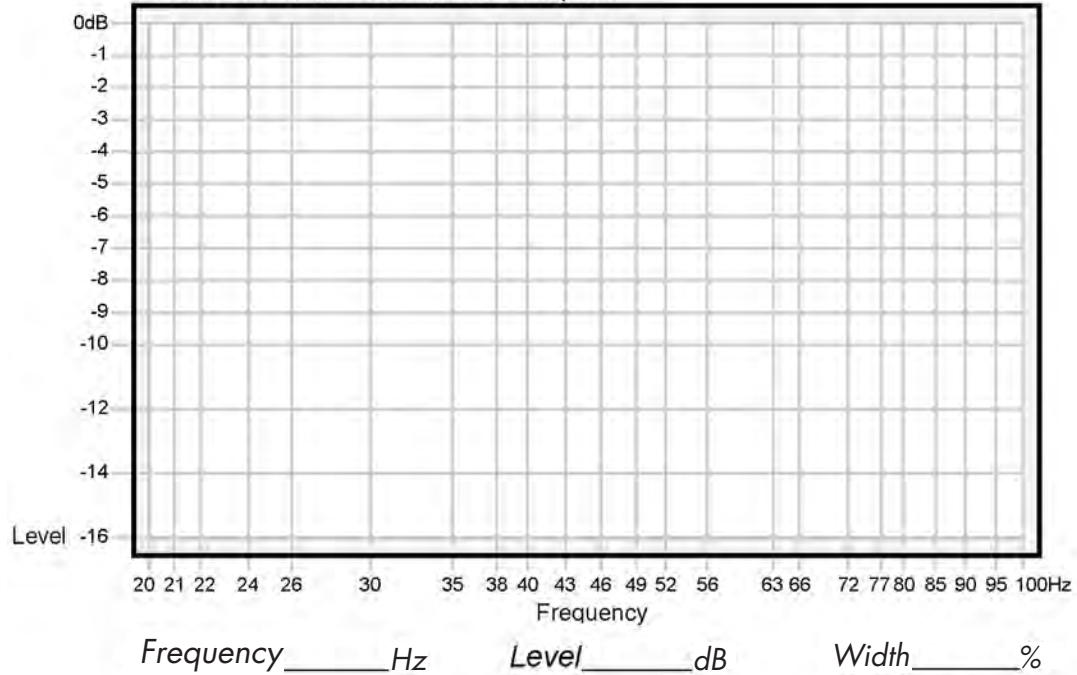

SPECIFICATIONS

Infinity Classia™ PSW310W

Frequency Response:	32Hz – 150Hz (–3dB) 28Hz – 150Hz (–6dB)
Amplifier RMS Power:	400 Watts RMS
Amplifier Peak Dynamic Power†:	700 Watts
Crossover Frequencies:	50Hz – 150Hz, continuously adjustable when activated
Driver:	10" (250mm) CMMD® Dual 10" (250mm) CMMD passive radiators
RF Operating Frequency:	2.4GHz
Operating Range:	Up to 75' (22m), depending upon conditions
Subwoofer Dimensions (H x W x D):	17-1/2" x 14" x 16-3/4" (445mm x 356mm x 426mm)
Subwoofer Weight:	49.8 lb (22.6kg)
Transmitter Dimensions:	3-3/4" x 4-7/8" x 3-15/16" (95mm x 124mm x 100mm)
Transmitter Weight:	0.5 lb (0.2kg)

† The peak dynamic power is measured by recording the highest center-to-peak voltage measured across the output of a resistive load equal to minimum impedance of the transducer, using a 50Hz sine wave burst, 3 cycles on, 17 cycles off.

Features, specifications and appearance are subject to change without notice.

NOTES



TECHNOLOGY • PERFORMANCE • DESIGN

Harman Consumer Group, Inc., 250 Crossways Park Drive, Woodbury, NY 11797 USA 516.674.4463 (USA only)

www.infinitysystems.com

Infinity and CMMD (patent nos. 6,327,372 and 6,404,897) are trademarks of Harman International Industries, Incorporated, registered in the United States and or/other countries. Infinity Classia, Room Adaptive Bass Optimization System and R.A.B.O.S. are trademarks of Harman International Industries, Incorporated.

Dolby is a registered trademark of Dolby Laboratories. DTS is a registered trademark of DTS, Inc.

Part No. 406-000-05338-E 6/08

© 2008 Harman International Industries, Incorporated. All rights reserved.

H A Harman International Company

Download from Www.Somanuals.com. All Manuals Search And Download.

Free Manuals Download Website

<http://myh66.com>

<http://usermanuals.us>

<http://www.somanuals.com>

<http://www.4manuals.cc>

<http://www.manual-lib.com>

<http://www.404manual.com>

<http://www.luxmanual.com>

<http://aubethermostatmanual.com>

Golf course search by state

<http://golfingnear.com>

Email search by domain

<http://emailbydomain.com>

Auto manuals search

<http://auto.somanuals.com>

TV manuals search

<http://tv.somanuals.com>