

Owner's Guide
Manual del usuario
Guide d'utilisation

NV28 | NV29 | NV30K | NV30CK

NV31K | NV31CK | NV32



INFINITY

Never loses suction | Nunca pierde la succión

Never loses suction | Nunca pierde la succión

Thank you for
purchasing the
Infinity Upright
Vacuum.

Contents

Important Safety Instructions	2
Getting Started	4
Using the Vacuum	6
Transporting the Vacuum	7
Cleaning with the Vacuum Accessories	8
Emptying the Dust Cup Assembly	10
Proper Care of Your Infinity Upright Vacuum	11
Troubleshooting	12
Checking for Blockages	13
Maintenance	14
Warranty and Registration	16



IMPORTANT SAFETY INSTRUCTIONS

SAVE THESE INSTRUCTIONS For Household Use Only

When using an electrical appliance, basic safety precautions should always be observed, including the following:

READ ALL INSTRUCTIONS BEFORE USING YOUR INFINITY UPRIGHT VACUUM.

WARNING:

To reduce the risk of electric shock, the two-pronged power cord plug is polarized [one prong is larger than the other]; it will fit into the outlet only one way. **DO NOT** force into outlet or try to modify to fit.

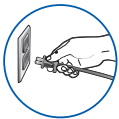

WARNING: TO REDUCE THE RISK OF ELECTRIC SHOCK OR INJURY. DO NOT USE OUTDOORS OR ON WET SURFACES:

▲ General Electrical Safety:

Unplug from electrical outlet when not in use and before servicing.

DO NOT use vacuum with a damaged cord or plug.

DO NOT pull or carry vacuum by the cord.

DO NOT unplug by pulling on cord; to unplug, grasp the plug, not the cord.

DO NOT handle plug or vacuum cleaner with wet hands.

DO NOT run the vacuum over the power cord.

DO NOT use the cord as a handle.

DO NOT close a door on the cord.

DO NOT pull cord around sharp corners.

DO NOT leave appliance when plugged in.

Keep cord away from heated surfaces.

Turn off all controls before plugging or unplugging vacuum cleaner.

Hose Attachments:

- ▲ DO NOT** use if air flow is restricted; if the air paths, the hose, or the extension tube become blocked, turn the vacuum cleaner off. Remove all obstructions before you turn on the unit again.

Keep the end of the hose, wands and other openings away from face and body.

Keep rotating brush and suction openings away from hair, face, fingers, uncovered feet or loose clothing.

Only use manufacturer's recommended attachments.

General Use:

- ▲** Use only as described in this manual.

DO NOT put any objects into openings.

Keep your work area well lit.

Keep the vacuum moving over the carpet surface at all times to avoid damaging the carpet fibers.

DO NOT place vacuum on unstable surfaces such as chairs or tables.

DO NOT allow young children to operate the vacuum or use as a toy.

DO NOT use vacuum cleaner if it has been dropped, damaged, left outdoors, or submerged in water. Return to EURO-PRO Operating LLC for examination, repair, or adjustment.

⚠️ Cyclonic Chamber/Dust Cup/Filters:

Before turning on the vacuum:

- Make sure that dust cup, cyclonic chamber and all filters are in place after routine maintenance.
- Make sure that all components and filters are thoroughly dry after routine cleaning.
- Only use filters and accessories provided by EURO-PRO Operating LLC [Failure to do so will void the warranty.]

⚠️ General Cleaning:

DO NOT run the vacuum over large-sized objects.

DO NOT pick up hard or sharp objects such as glass, nails, screws or coins that could damage the vacuum cleaner.

DO NOT pick up smoking or burning objects such as hot coals, cigarette butts, or matches.

DO NOT pick up flammable or combustible materials such as lighter fluid, gasoline, kerosene or use in areas where they may be present.

DO NOT pick up toxic solutions such as chlorine bleach, ammonia, or drain cleaner.

DO NOT use in an enclosed space where vapors are present from paint, paint thinner, moth-proofing substances, flammable dust or other explosive or toxic materials.

DO NOT vacuum up any liquids.

DO NOT immerse vacuum cleaner in water or other liquids.

DO NOT use outdoors or on wet surfaces; use only on dry surfaces.

Use extra care when cleaning on stairs.

Getting Started

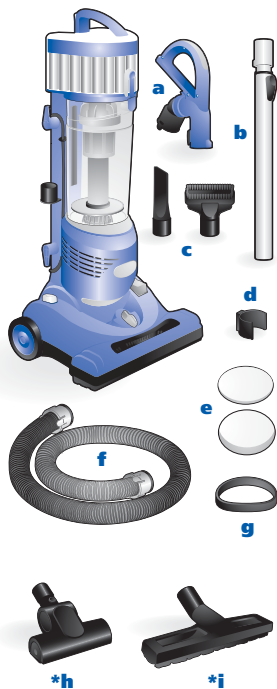

Along with your upright unit, you will find the following components:

- a** Detachable Handle (Ergonomic Grip)
- b** Telescopic Wand
- c** Cleaning Attachments
- d** Upper Hose Holder
- e** Extra Filters
- f** Super Stretch Hose
- g** Spare Motor Belt

***Note:** depending on the model you select, your Infinity comes with a Pet Hair Power Brush (**h**) and Low Reach Bare Floor Brush (**i**) that are kept in a separate accessory bag.

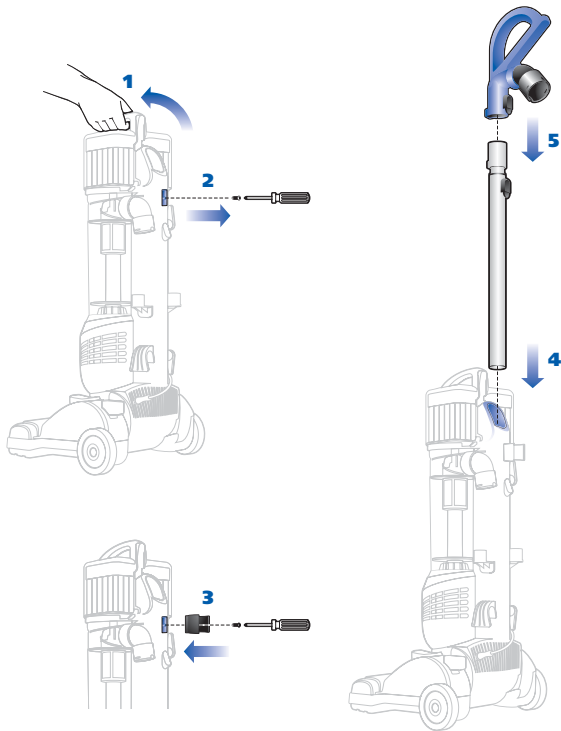

Your Infinity Upright is a snap to assemble:

- 1** Lock into upright position.
- 2** Attach the Upper Hose Holder: use a Phillips Head screwdriver to remove the screw attached to the vacuum body.
- 3** Place the Upper Hose Holder into the slot; screw the holder onto the vacuum body.

- 4** Slide the Telescopic Wand into the upright unit to click in place.
- 5** Slide the Detachable Handle onto the Telescopic Wand.

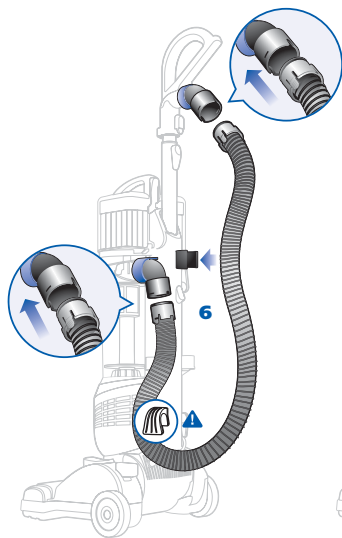

- 6** Attach each end of the Super Stretch Hose to the vacuum and press into Upper Hose Holder for easy storage.



▲ IMPORTANT:
To prevent vacuum from tipping, secure hose in lower holder.

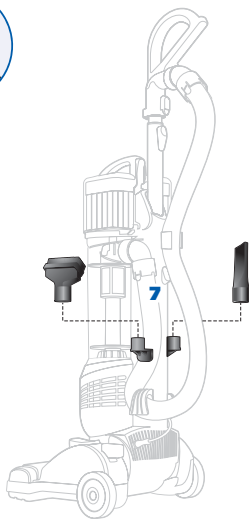

- 7** Store Crevice Tool and Upholstery/ Dusting Brush on the unit.

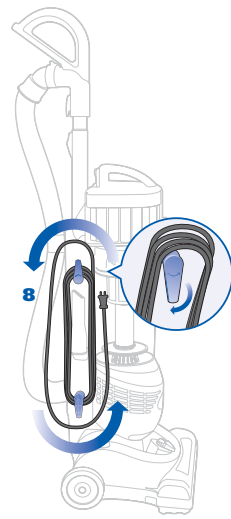

- 8** When storing your vacuum, wind cord around the two cord holders and secure with cord clip:

- Quick Cord release at the top of the unit – place in the upright position.
- Second holder [fixed] near the base.

To release the cord, turn the Quick Cord release to the left or right.

Using the Vacuum

Your Infinity Upright Vacuum is a versatile tool that can be used to clean bare floor surfaces or carpets – with the click of a button.

Lock vacuum into the upright position.

Plug in the vacuum.

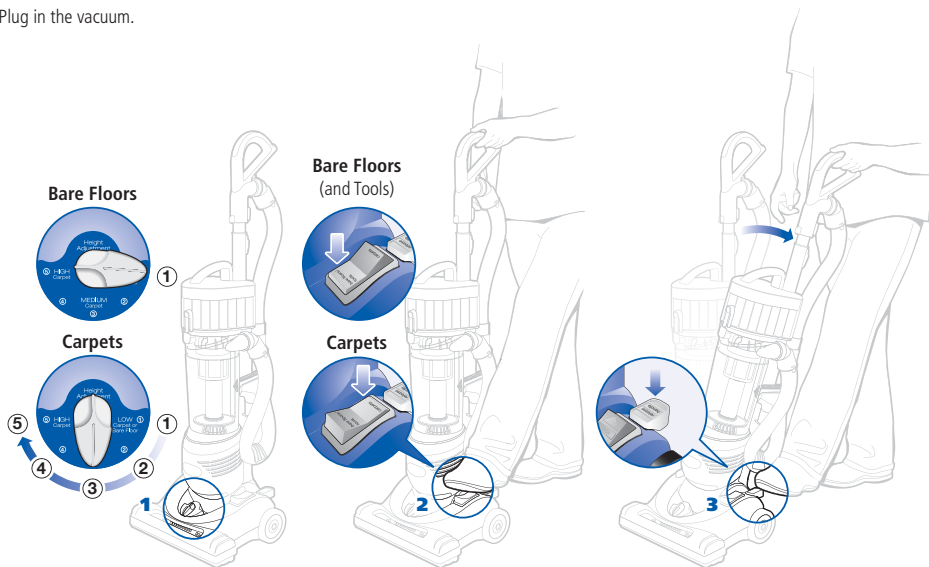

- 1 Set the Height Adjustment Dial.

When cleaning bare floors:

Set Height Adjustment Dial at ①

When cleaning carpets:

Adjust the Height Adjustment Dial from ① to ⑤, depending on your carpet style (low pile/scatter rugs, plush carpets, deep pile carpets).

- Select lowest setting for maximum cleaning.
- Select higher settings for easier pushing on thicker carpets.

- 2 Set the Brush Roll Pedal for **bare floors/tools** or **carpets**.

When cleaning bare floors:

Depress **bare floors/tools** side of pedal [forward] to lock the brush roll.

When cleaning carpets:

Depress **carpets** side of pedal [back] to engage the brush roll.

- 3 Step on Handle Release Pedal to release unit from locked position.

Transporting the Vacuum

Lock vacuum into the upright position.

Unplug the vacuum.

Wind cord around the two cord holders.

Secure Super Stretch Hose in both hose holders.

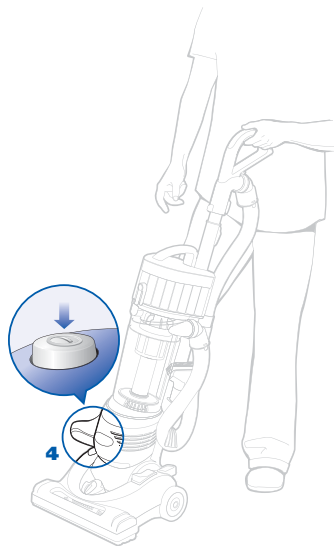

- 4** Step on Power Button to turn unit on and off.

Push to vacuum.

Note: If vacuum is difficult to push, adjust the Height Adjustment Dial until vacuum glides easily over the carpet surface.



- 1** To roll the vacuum:

Hold the Detachable Handle (Ergonomic Grip) and tilt unit back on wheels.

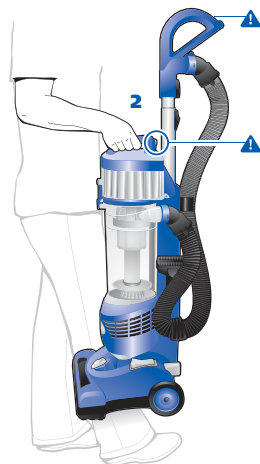

- 2** To carry the vacuum:

Make sure unit is locked into the upright position.

Lift by the Dust Cup Assembly Handle (carry handle).

⚠ CAUTION:
DO NOT use the Detachable Handle (Ergonomic Grip) to carry unit.

⚠ CAUTION:
When lifting or carrying, **DO NOT** press Dust Cup Assembly release button.

Cleaning with the Vacuum Accessories

Before cleaning with your accessories:

Lock vacuum into upright position.

Secure Super Stretch Hose in the lower hose holder to prevent tipping.



Change the Brush Roll Pedal to the **bare floors/tools** position.

⚠ **DO NOT** pull vacuum cleaner around by the hose.

⚠ **DO NOT** overextend the hose beyond its reach.

Vacuum Accessories

Your vacuum comes a Detachable Handle and Telescopic Wand. Use one or the other to attach your cleaning accessories.

Super Stretch Hose – extends so that you can reach the length of a typical staircase.

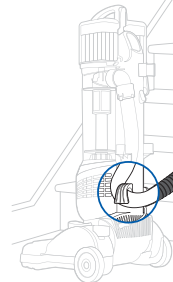

Crevice Tool – this tool is used for cleaning between cushions, under radiators and baseboards, or hard-to-reach crevices and corners.

Upholstery/Dusting Brush – this tool can be used with or without the Dusting Brush attachment.

Attach or remove the Dusting Brush with one snap. With the Dusting Brush in place, you can dust a variety of surfaces from furniture and window blinds to lamp shades and book shelves; without the Dusting Brush attachment, use the tool to remove dust and/or pet hairs from upholstery surfaces and carpeted stairs.

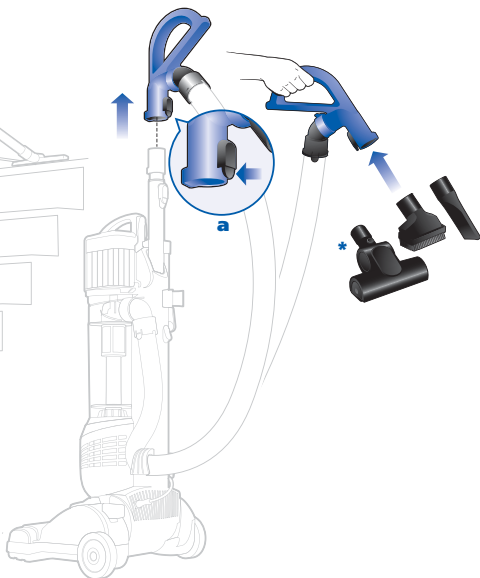

Using the Detachable Handle:

Lock vacuum into upright position.

Press the Detachable Handle release button (a) to release handle.

The Detachable Handle and Super Stretch Hose are now separate from the Telescopic Wand.

Push the selected cleaning tool into the handle.



Using the Telescopic Wand:

Lock vacuum into upright position.

Press the Telescopic Wand release button (b).

Hold Telescopic Wand and pull out of unit.

Push the selected cleaning tool onto the end of the wand.

Press the Telescopic Height Adjustment Button (c) to adjust wand to desired length.

***Note:** depending on the model you select, your Infinity comes with a Pet Hair Power Brush and Low Reach Bare Floor Brush that are kept in a separate accessory bag.



Pet Hair Power Brush – this unique tool has dual felt strips along the cleaning surface that are designed for heavy-duty pet hair removal.

Low Reach Bare Floor Brush – only use this tool with the Telescopic Wand. The Bare Floor Brush is used when you need to clean floor surfaces such as hardwood, hardwood laminates, and tile. The soft natural bristles provide an easy-glide action to protect all bare floor surfaces.

Note: you should only use the Low Reach Bare Floor Brush with the Telescopic Wand.

To order additional parts and accessories, go to www.infinityvac.com or call 1-888-668-9600. **Note:** some parts may be available at your local Infinity retailer.

Emptying the Dust Cup Assembly

For best results empty the Dust Cup Assembly after each use; empty several times during prolonged usage.

Or empty the Dust Cup Assembly when it reaches the **MAX** fill line; **NEVER OVER-FILL THE DUST CUP.**

Lock vacuum into upright position.

Turn vacuum off.

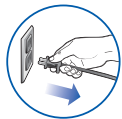

⚠ CAUTION:
Unplug the vacuum;
failure to do so
Might result in
electric shock.



To empty the Dust Cup Assembly:

- 1 Grip carry handle and press the Dust Cup release button to remove Dust Cup Assembly.



- 2 Insert Dust Cup Assembly deep inside trash receptacle to contain dust and debris.

Press the Dust Cup Door release button; tap container gently to dislodge and release dust and debris.

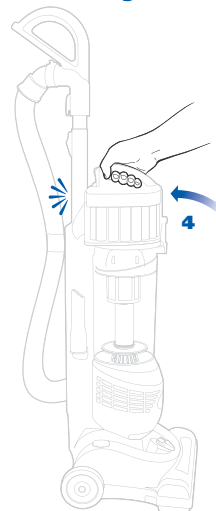
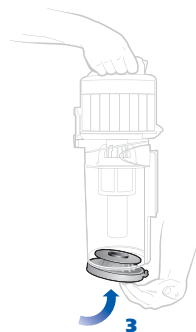

- 3 Snap door in place.
- 4 Position Dust Cup Assembly at a forward angle over unit and then snap into place.

Proper Care of Your Infinity Upright Vacuum

Date Purchased: / /

For proper care, consult the table to the right for the maintenance schedule of your Cyclonic Chamber and Filters.

Lock vacuum into upright position.

Turn vacuum off.

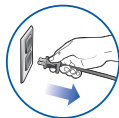

⚠ CAUTION:
Unplug the vacuum;
failure to do so
might result in
electric shock.

Remove Dust Cup Assembly.

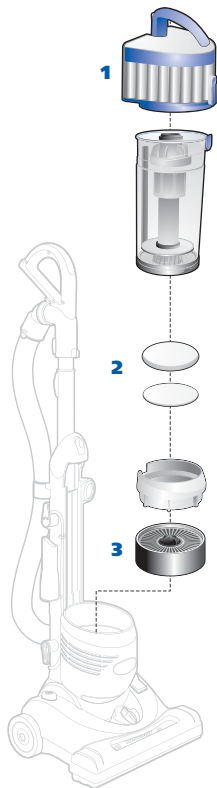

Component	Maintenance Schedule
1 Cyclonic Chamber	Empty every 3 to 5 months, under normal use
2 Foam and Felt Filters (2)	Wash every 3 to 5 months, under normal use
3 HEPA Filter	Tap clean every 3 years for optimum performance

1 Cleaning the Cyclonic Chamber:

Twist Cyclonic Chamber to the left (counter clockwise) to unlock and separate from Dust Cup (**a**).

Press Cyclonic Chamber Release Button to open the bottom door (**b**).

Gently tap open Cyclonic Chamber over trash receptacle to release dust and then close chamber door.

Position Cyclonic Chamber onto Dust Cup; line up the solid arrows on the back (**c**).

Twist Cyclonic Chamber to the right (clockwise) until the top solid arrow lines up with the bottom open arrow (**d**) to lock.

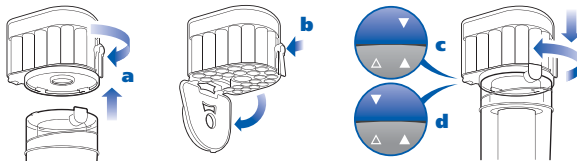

2 Washing the Foam and Felt Filters:

Remove the Foam and the Felt Filters from the Filter Holder.

Rinse in lukewarm water until water runs clear.

Squeeze filters and let air dry for **24 hours** before replacing; do not use hairdryer or other heating methods to dry. Insert replacement filters while others are drying.

⚠ DO NOT operate the vacuum **without** ALL the filters in place.

⚠ DO NOT operate vacuum with **WET** filters.

3 Cleaning the HEPA Filter:

Lift up the Foam/Felt Filter Holder to access the HEPA Filter.

Lift out the HEPA Filter Unit.

Tap vigorously against a firm surface to dislodge residual dust particles.

NOTE: Your white Foam, Felt, and HEPA Filters will discolor over time; this is normal and will not affect the performance of the filters.

Troubleshooting

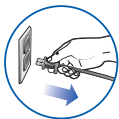

⚠ WARNING: to reduce the risk of electric shock, the power cord must be disconnected before performing maintenance/troubleshooting checks.

Problem	Suggested Action
Vacuum will not run.	<p>Check to see if plugged in properly.</p> <p>Check circuit breaker/fuse.</p> <p>Check On/Off switch.</p> <p>If vacuum still does not run, see Resetting the Motor Thermostat on page 14.</p>
Vacuum is not picking up dirt.	<p>Check the Dust Cup.</p> <p>Check the Filters.</p> <p>Check Height Adjustment Dial setting; see Using the Vacuum on page 6.</p> <p>If the Dust Cup doesn't need cleaning, check for blockages; see Checking for Blockages on next page.</p>
Vacuum pushes scatter rugs (lightweight, movable rugs) on carpets setting.	<p>Move carpet-to-floor pedal to bare floors/tools to disengage the Brush Roll.</p>
Vacuum too hard to push on carpets setting.	<p>Raise Height Adjustment Dial setting until vacuum glides easily over carpet; see Using the Vacuum on page 6.</p>
Vacuum turns off on its own.	<p>Motor Thermostat needs to be reset; see Resetting the Motor Thermostat on page 14.</p>
Headlight is off.	<p>Change bulb; see Changing the Headlight Bulb on page 14.</p>
Brush roll does not engage when pedal is in carpets position.	<p>Check to see if belt is broken or improperly installed.</p> <p>Change belt, if broken; see Replacing the Power Nozzle Drive Belt on page 14.</p>
Airflow is restricted.	<p>Check for blockages; see Checking for Blockages on next page.</p> <p>Check attachments for suction strength; clear blockages, as required.</p>

Checking for Blockages

Blockages may cause your vacuum to overheat and shut down. If so, clear the blockages, then follow the instructions for **Resetting the Motor Thermostat** on page 14.

⚠ WARNING: Never insert sharp objects into any opening to clear an obstruction.

⚠ IMPORTANT: Damages caused while clearing or attempting to clear blockages are not covered under your product's limited warranty.

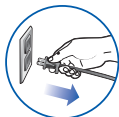

Unplug the vacuum before checking for blockages.

Reassemble all parts securely before operating vacuum.

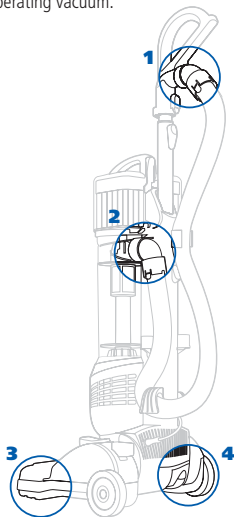

1 Detachable Handle:

Lock vacuum into upright position.

Remove Detachable Handle and Telescopic Wand; disconnect the hose.

Check both openings on the Detachable Handle, hose, and wand for clogs.

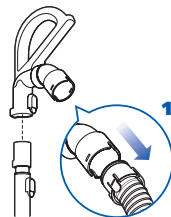

2 Dust Cup Air Duct:

Lock into upright position.

Remove Dust Cup Assembly and empty Dust Cup, if necessary.

Disconnect the Super Stretch Hose.

Check Air Duct behind Dust Cup for clogs; clear before replacing Dust Cup Assembly.

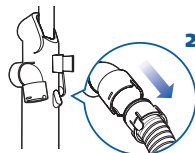

3 Intake Opening behind the Brush Roll:

Lock vacuum and lay flat.

Check opening behind the Brush Roll for clogs.

Clear the opening.

Clear the Brush Roll; use scissors to carefully cut away threads, hair or other debris that might be trapped in the bristles.

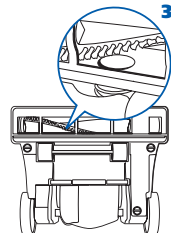

4 Nozzle Hose Connector:

Remove Dust Cup Assembly.

Lock vacuum, lay flat and turn over.

Use a Phillips Head screwdriver to:

- a** Remove 2 screws from the access port cover and remove.
- b** Remove 2 screws to release the Nozzle Hose.

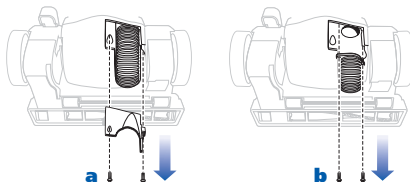

Check Nozzle Hose for clogs.

Maintenance

Changing the Headlight Bulb

You will need to order replacement bulbs from: www.infinityvac.com or contact Customer Service at: **1-888-668-9600**.

Turn power off.

Unplug the vacuum.

Unlock vacuum and lay flat.

Insert a Flathead screwdriver into one of the two top slots of the Headlight Cover; gently pry off cover from slots.

Pull out the used light bulb.

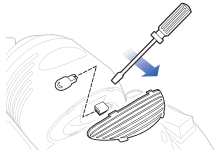

Push new light bulb into place.

Slide bottom tabs of the cover in first; then snap top slots into place.

Resetting the Motor Thermostat

Your Infinity Upright Vacuum is equipped with a protective Motor Thermostat. If the motor should overheat, the thermostat shuts off the power.

To reset the Motor Thermostat:

Press the **On/Off Button** once to turn power off.

Unplug the vacuum.

Check for clogged hose or filter; unplug hose and replace filter. Refer to **Checking for Blockages** on page 13.

Wait 45 minutes for vacuum to cool; then plug in the vacuum.

Press the **On/Off Button** to start the vacuum.

Note: if vacuum still does not start, contact Customer Service at: **1-888-668-9600**.

Replacing the Power Nozzle Motor Belt

If the brush roll does not engage when the carpet-to-floor pedal is in the **carpets** position, the belt may be worn or broken.

To remove worn or damaged Belt:

! IMPORTANT: Depress **carpets** side of pedal [back] to engage the brush roll for proper belt alignment.

If pedal is in the **bare floors/tools** position the belt will not align properly on the belt shifter and will break.

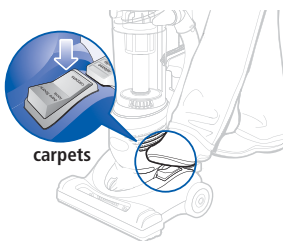

Turn power off.

Unplug the vacuum.

Remove Dust Cup Assembly.

Lock vacuum, lay flat and turn over.

Use Flathead screw driver [or a coin] to turn three screws on the belt and brush roll cover counter clockwise **(a)** to unlock.

Remove Belt and Brush Roll Cover **(b)**.

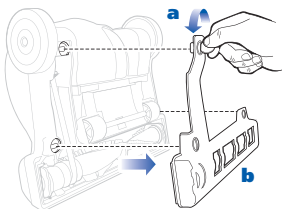

Grasp both sides of the Brush Roll; with even tension, partially remove the right side from the side holder first then the left **(c)**.

Then lift up the Brush Roll to relieve tension on the belt.

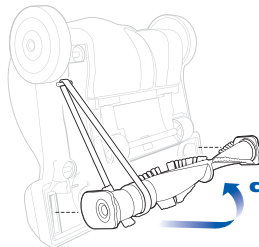

Slip Belt off the Brush Roll.

Remove Belt from the motor-driven shaft **(d)**.

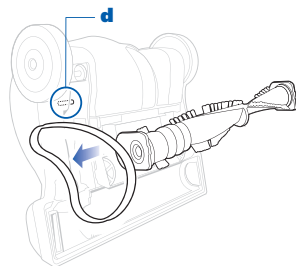

With the Brush Roll free, inspect for any hair build-up or string; if present, carefully cut out with scissors; take care not to damage the bristles.

To replace new Belt:

Slide one end of the new Belt over the motor-driven shaft (e).

Slide second end of the Belt around Brush Roll (f).

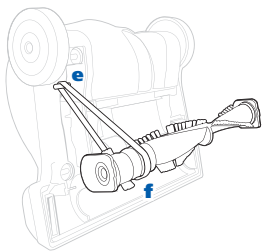

Partially insert the right end of the roller into one side holder (g).

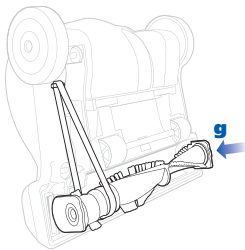

Partially insert the left end into the other side holder (h).

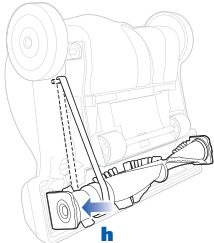

Push both ends all the way into the side holders at the same time.

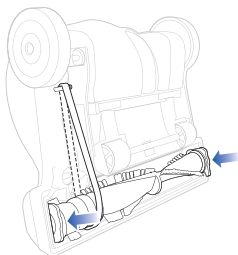

Center Belt on motor-driven shaft; test Brush Roll for easy turning.

Line up the 4 tabs on the Belt and Brush Roll Cover with the slots in the Power Nozzle (i); push into place.

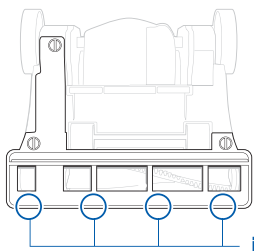

Turn the three locking screws clockwise (j) to tighten.

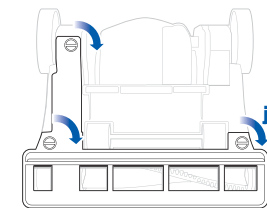

Cleaning the Pet Hair Power Brush

Slide locking latch (k) forward.

Gently tilt brush housing upward to open.

IMPORTANT: DO NOT force; it will not open all the way.

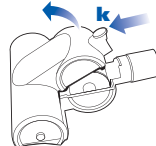

Remove debris from turbine wheel and air passage.

Ordering Replacement Parts

To order additional parts and accessories, go to www.infinityvac.com or call **1-888-668-9600**. **Note:** some parts may be available at your local Infinity retailer.

Part	Part No.
Motor Belt	1102-PP
Headlight Bulb	1088-PP
Foam and Felt Filters	1083-PP
HEPA Filter	1082-PP
Telescopic Wand	1121-PP
Detachable Handle	1119-PP
Super Stretch Hose	1120-PP
Upper Hose Holder	1086-PP
Crevice Tool	1084-PP
Upholstry/Dusting Brush	
Pet Hair Power Brush	1097-PP
Low Reach Bare Floor Brush	

Warranty and Registration

Your Infinity Upright Vacuum comes with a Five year limited warranty.

FOR CANADIAN CONSUMERS ONLY

Please fill out and mail the **Owner Registration Card** within ten (10) days of purchase. The registration will enable us to contact you in the unlikely event of a product safety notification. By returning this card you acknowledge to have read and understood the instructions for use, and warnings set forth in the accompanying instructions.

EURO-PRO FIVE-YEAR (5) LIMITED WARRANTY

EURO-PRO Operating LLC warrants this product to be free from defects in material and workmanship for a period of five (5) years from the date of the original purchase, when utilized for normal household use, subject to the following conditions, exclusions and exceptions.

If your appliance fails to operate properly while in use under normal household conditions within the warranty period, return the complete appliance and accessories, freight prepaid to:

- **U.S.: EURO-PRO Operating LLC**
For customer service support call 1-800-798-7398 or visit www.euro-pro.com
- **Canada: EURO-PRO Operating LLC**
4400 Bois Franc, St. Laurent, Québec H4S 1A7

If the appliance is found to be defective in material or workmanship, **EURO-PRO Operating LLC** will repair or replace it free of charge. Proof of purchase date and \$16.99 to cover the cost of return shipping and handling must be included.*

Non-durable parts including, without limitation, filters, brushes and electrical parts which normally require replacement are specifically excluded from warranty.

The liability of **EURO-PRO Operating LLC** is limited solely to the cost of the repair or replacement of the unit at our option. This warranty does not cover normal wear of parts and does not apply to any unit that has been tampered with or used for commercial purposes. This limited warranty does not cover damage caused by misuse, abuse, negligent handling or damage due to faulty packaging or mishandling in transit. This warranty does not cover damage or defects caused by or resulting from damages from shipping or repairs, service or alterations to the product or any of its parts, which have been performed by a repair person not authorized by **EURO-PRO Operating LLC**.

This warranty is extended to the original purchaser of the unit and excludes all other legal and/or conventional warranties. The responsibility of **EURO-PRO Operating LLC** if any, is limited to the specific obligations expressly assumed by it under the terms of the limited warranty. In no event is **EURO-PRO Operating LLC** liable for incidental or consequential damages of any nature whatsoever. Some states do not permit the exclusion or limitation of incidental or consequential damages, so the above may not apply to you.

This warranty gives you specific legal rights, and you may also have other rights which vary from state to state or province to province.

***IMPORTANT:** Carefully pack item to avoid damage in shipping. Be sure to include proof of purchase date and to attach tag to item before packing with your name, complete address and phone number with a note giving purchase information, model number and what you believe is the problem with item. We recommend you insure the package (as damage in shipping is not covered by your warranty). Mark the outside of your package "**ATTENTION CUSTOMER SERVICE**". We are constantly striving to improve our products, therefore the specifications contained herein are subject to change without notice.

Manufactured by:

EURO-PRO Operating LLC

Copyright© Euro-Pro Operating LLC 2008

Printed in China



Owner Registration Card

FOR CANADIAN CONSUMERS ONLY

Please fill out and mail this sheet within ten (10) days of purchase. The registration will enable us to contact you in the unlikely event of a product safety notification. By returning this card you acknowledge to have read and understood the instructions for use, and warnings set forth in the accompanying instructions. Mail to the following address:

- **Canada: EURO-PRO Operating LLC**
4400 Bois Franc, St. Laurent, Québec H4S 1A7

Owners Name:

Address:

City:

Prov.:

Postal Code:

Date Purchased:

Name of Store:

Vacuum Model:

U.S.: EURO-PRO Operating LLC
Boston, MA 02465

Canada: EURO-PRO Operating LLC
4400 Bois Franc
Ville St. Laurent, Québec H4S 1A7

1-888-668-9600

www.infinityvac.com

COPYRIGHT © EURO-PRO OPERATING LLC 2008

DERECHOS RESERVADOS © EURO-PRO OPERATING LLC 2008

TOUS DROITS RÉSERVÉS © EURO-PRO OPERATING LLC 2008

PRINTED IN CHINA

IMPRESO EN CHINA

IMPRIMÉ EN CHINE REV. 080220

Free Manuals Download Website

<http://myh66.com>

<http://usermanuals.us>

<http://www.somanuals.com>

<http://www.4manuals.cc>

<http://www.manual-lib.com>

<http://www.404manual.com>

<http://www.luxmanual.com>

<http://aubethermostatmanual.com>

Golf course search by state

<http://golfingnear.com>

Email search by domain

<http://emailbydomain.com>

Auto manuals search

<http://auto.somanuals.com>

TV manuals search

<http://tv.somanuals.com>