

**“000-1” SERIES RIGHT-ANGLE GRINDER/SANDER
MODELS 8479-1-(), 8479-2-(), 8480-1-() AND 8480-2-()**

NOTICE

ARO is not responsible for customer modification of tools for applications on which ARO was not consulted.



⚠ WARNING

**IMPORTANT SAFETY INFORMATION ENCLOSED.
READ THIS MANUAL BEFORE OPERATING TOOL.
IT IS THE RESPONSIBILITY OF THE EMPLOYER TO PLACE THE INFORMATION
IN THIS MANUAL INTO THE HANDS OF THE OPERATOR.
FAILURE TO OBSERVE THE FOLLOWING WARNINGS COULD RESULT IN INJURY.**

PLACING TOOL IN SERVICE

- Always operate, inspect and maintain this tool in accordance with American National Standards Institute Safety Code for Portable Air Tools (ANSI B186.1).
- For safety, top performance, and maximum durability of parts, operate this tool at 90 psig (6.2 bar/620 kPa) maximum air pressure at the inlet with 5/16” (8 mm) inside diameter air supply hose.
- Always turn off the air supply and disconnect the air supply hose before installing, removing or adjusting any accessory on this tool, or before performing any maintenance on this tool.
- Do not use damaged, frayed or deteriorated air hoses and fittings.
- Be sure all hoses and fittings are the correct size and are tightly secured. See Dwg. TPD905-1 for a typical piping arrangement.
- Always use clean, dry air at 90 (6.2 bar/ 620 kPa) psig maximum air pressure. Dust, corrosive fumes and/or excessive moisture can ruin the motor of an air tool.
- Do not lubricate tools with flammable or volatile liquids such as kerosene, diesel or jet fuel.
- Do not remove any labels. Replace any damaged label.

USING THE TOOL

- Always wear eye protection when operating or performing maintenance on this tool.
- Always wear hearing protection when operating this tool.
- Keep hands, loose clothing and long hair away from rotating end of tool.
- Anticipate and be alert for sudden changes in motion during start up and operation of any power tool.
- Keep body stance balanced and firm. Do not overreach when operating this tool. High reaction torques can occur at or below the recommended air pressure.
- Tool accessories may continue to rotate briefly after throttle is released.
- Air powered tools can vibrate in use. Vibration, repetitive motions or uncomfortable positions may be harmful to your hands and arms. Stop using any tool if discomfort, tingling feeling or pain occurs. Seek medical advice before resuming use.
- Use accessories recommended by ARO.
- This tool is not designed for working in explosive atmospheres.
- This tool is not insulated against electric shock.

NOTICE

The use of other than genuine ARO replacement parts may result in safety hazards, decreased tool performance, and increased maintenance, and may invalidate all warranties.

Repairs should be made only by authorized trained personnel. Consult your nearest ARO Authorized Servicenter.

For parts and service information, contact your local ARO distributor, or the Customer Service Dept. of the Ingersoll-Rand Distribution Center, White House, TN at PH: (615) 672-0321, FAX: (615) 672-0801.

ARO Tool Products

Ingersoll-Rand Company

1725 U.S. No. 1 North • P.O. Box 8000 • Southern Pines, NC 28388-8000

©2000 INGERSOLL-RAND COMPANY • PRINTED IN U.S.A.





WARNING LABEL IDENTIFICATION

⚠ WARNING

FAILURE TO OBSERVE THE FOLLOWING WARNINGS COULD RESULT IN INJURY.

	<p>⚠ WARNING</p> <p>Always wear eye protection when operating or performing maintenance on this tool.</p>
---	--

	<p>⚠ WARNING</p> <p>Always wear hearing protection when operating this tool.</p>
---	---

	<p>⚠ WARNING</p> <p>Always turn off the air supply and disconnect the air supply hose before installing, removing or adjusting any accessory on this tool, or before performing any maintenance on this tool.</p>
--	--



	<p>⚠ WARNING</p> <p>Air powered tools can vibrate in use. Vibration, repetitive motions or uncomfortable positions may be harmful to your hands and arms. Stop using any tool if discomfort, tingling feeling or pain occurs. Seek medical advice before resuming use.</p>
--	---

	<p>⚠ WARNING</p> <p>Do not carry the tool by the hose.</p>
---	---

	<p>⚠ WARNING</p> <p>Do not use damaged, frayed or deteriorated air hoses and fittings.</p>
--	---

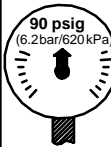
	<p>⚠ WARNING</p> <p>Keep body stance balanced and firm. Do not overreach when operating this tool.</p>
---	---

	<p>⚠ WARNING</p> <p>Operate at 90 psig (6.2 bar/ 620 kPa) Maximum air pressure.</p>
---	--

⚠ WARNING	
<p>⚠ WARNING</p> <p>Read the manual before operating this tool. Operate at 90 psig/6.2 bar max.</p>	  
PN 48176-1 LABEL (NON-EU MODELS)	PN 49883 LABEL (-EU MODELS)
This label must appear on the tool at all times. If it is lost or damaged, a replacement label is available at no cost.	

SANDER SPECIFIC WARNINGS

- Use only a sanding pad, buffing wheel or polishing bonnet with these tools. Do not use any grinding wheel, bur or metal removing accessory other than a sanding pad with these tools. Never use an accessory having a maximum operating speed less than the free speed of the Sander in which it is being used.
- These Sanders will operate at the free speed specified on the nameplate if the air supply line furnishes 90 psig (6.2 bar/620 kPa) air pressure at the tool. Operation at higher air pressure will result in excessive speed.
- Do not operate this Sander away from the work surface.
- Check for excessive speed and vibration before operating.
- Do not use this tool if actual free speed exceeds the nameplate rpm.
- Never exceed the rated rpm of tool.
- Whenever the Angle Head is installed or repositioned, the Throttle Lever must be positioned so that reaction torque will not tend to retain the throttle in the "ON" position.
- Repeated prolonged operator exposure to vibrations which may be generated in the use of certain hand-held tools may produce Raynaud's phenomenon, commonly referred to as Whitefinger disease. The phenomenon produces numbness and burning sensations in the hand and may cause circulation and nerve damage as well as tissue necrosis. Repetitive users of hand-held tool who experience vibrations should closely monitor duration of use and their physical condition.
- When using a pad having a shank, insert the shank to full depth in the collet. When using a pad on a threaded arbor, make certain the flange nut is tightened securely. Check the tightness of the collet nut or flange nut before operating a Sander to make certain it will not loosen during operation.

LUBRICATION



<u>Where Used</u>	<u>ARO Part #</u>	<u>Description</u>
Air Motor	29665	1 qt. Spindle Oil
"O" Rings & Lip Seals	36460	4 oz. Stringy Lubricant
Gears and Bearings	33153	5 lb. "EP" – NLGI #1 Grease

Always use an air line lubricator with these tools. We recommend the following Filter–Lubricator–Regulator Unit:

ARO Model C28231–810

After each 8 hours of tool operation – Fill lubricator reservoir of recommended F.R.L. with spindle oil (29665). If an in line or air line lubricator is not used, apply several drops of spindle oil (29665) in air inlet.

After each 40 hours of tool operation – Flush tool with a solution of three (3) parts cleaning solvent to one (1) part spindle oil.

After each 160 hours of tool operation – Lubricate gearing of tool thru grease fitting with ARO 33153 grease or equivalent. Gearing should contain approximately 1/16 oz. (1.8 g) of grease. Pack bearings with NLGI #1 "EP" grease (33153).

CAUTION

Do not mark any nonmetallic surface on this tool with customer identification codes. Such actions could affect tool performance.

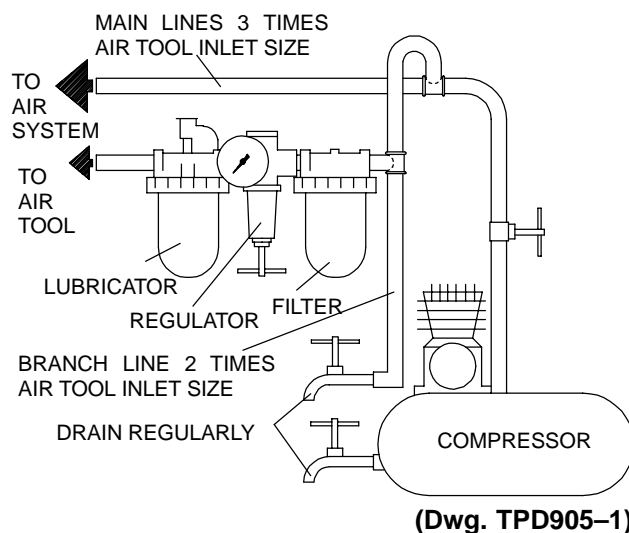

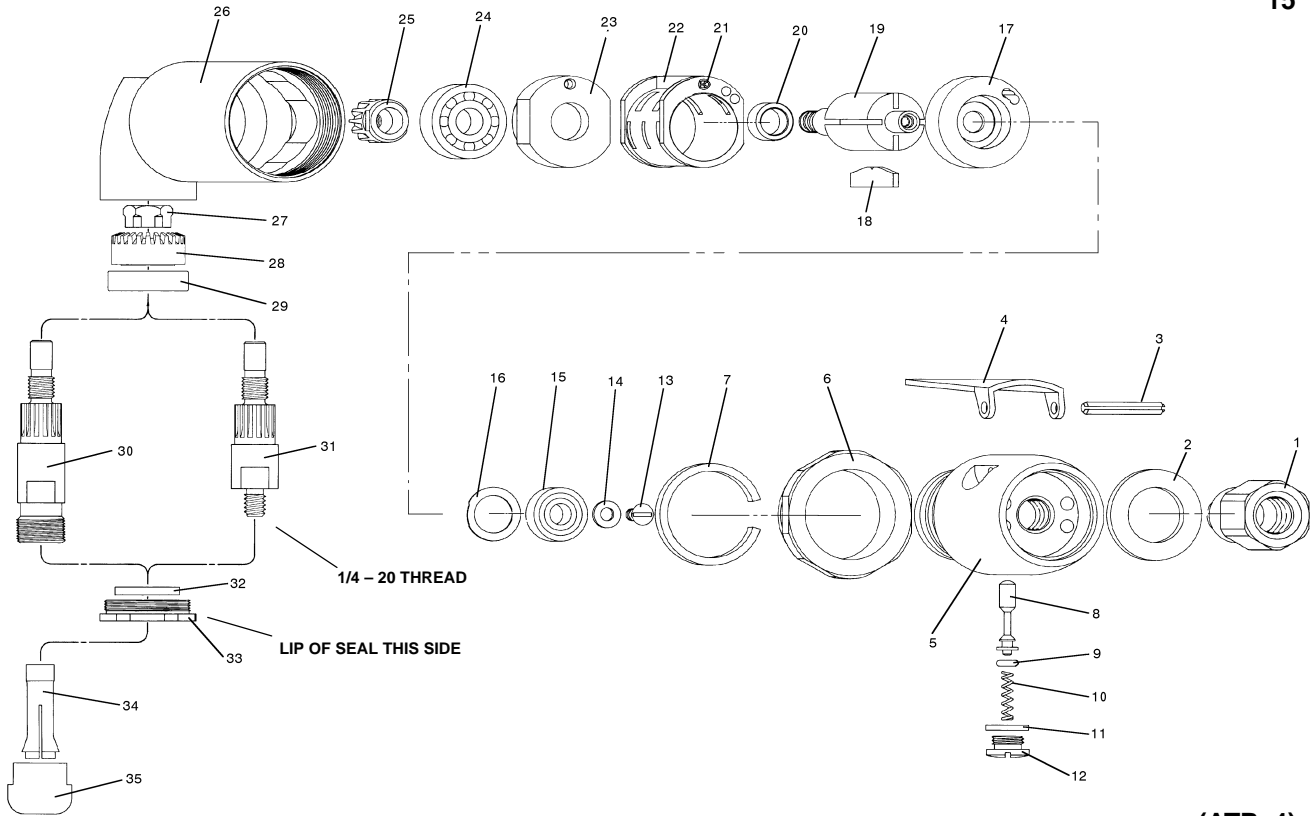

(ATP-4)

22 INCLUDES ROLL PIN (2) Y178-1

15/24 INSTALL WITH SHIELDED SIDE OUT

26 INCLUDES BEARING 43902 AND GREASE FITTING 35967

27 ASSEMBLE WITH THREAD ADHESIVE AND TORQUE TO 15 - 18 FT LBS.

30 USED WITH MODELS 8479-1-() AND 8479-2-()

31 USED WITH MODELS 8480-1-() AND 8480-2-()

32 PRESS TO A DEPTH OF .125" ±.015".

33 ASSEMBLE WITH THREAD ADHESIVE AND TORQUE TO 19 - 21 FT LBS.

34/35 USED WITH MODELS 8479-1-() AND 8479-2-()

NOT SHOWN
48176-1 WARNING LABEL (STANDARD MODELS)
49883 WARNING LABEL (-EU MODELS)

MODEL NUMBER	R.P.M.	LEVER (ITEM 4)	HEAD (ITEM 5)	PINION (ITEM 25)	HOUSING (ITEM 26)	GEAR (ITEM 28)	COLLET (ITEM 34)	CAPACITY
8479-1	13,000	40269	44653	44643	44644	44642	41750-3	1/4"
8479-1-EU	13,000	45953	49945	44643	49968	44642	41750-12	6 mm
8479-2	20,000	40269	44653	44640	44644	44696	41750-3	1/4"
8479-2-EU	20,000	45953	49945	44640	49968	44696	41750-12	6 mm
8480-1	13,000	40269	44653	44643	44644	44642		
8480-1-EU	13,000	45953	49945	44643	49968	44642		
8480-2	20,000	40269	44653	44640	44644	44696		
8480-2-EU	20,000	45953	49945	44640	49968	44696		

MODELS WITH -EU SUFFIX ARE "EC" COMPLIANT MODELS.

PART NUMBER FOR ORDERING

PART NUMBER FOR ORDERING

1	Inlet Adapter	44652-1	25	MOTOR ASSEMBLY (includes items 13 thru 24)	44645
2	Air Diffuser	44649	26	Bevel Pinion	See table
3	Roll Pin	Y178-44	27	Housing	See table
4	Throttle Lever (for -EU models see page 6)	See table	28	Nut	43749
5	Head	See table	29	Bevel Gear	See table
6	Lock Nut	44654	30	Ball Bearing	43750
7	Retaining Ring	Y110-24	31	Collet Shaft	44646
8	Valve	39382	32	Drive Shaft	45171
9	"O" Ring	Y325-6	33	Lip Seal	41447
10	Spring	43244	34	Bearing Lock Nut	43909
11	Washer	31389	35	Collet	See table
12	Cover Screw	33920		Collet Nut	41751
13	Screw	Y8-463-C		OPTIONAL	
14	Washer	Y48-6		Sanding Pad (2")	44648
15	Ball Bearing	42516		Sanding Pad (3")	44647
16	Wavy Spring	43150		Collet (1/8" cap.)	41750-1
17	Rear End Plate	43185		Collet (3/16" cap.)	41750-2
18	Rotor Blade (4 req'd)	41638		Collet (3 mm cap.)	41750-11
19	Rotor	44641		Collet (6 mm cap.)	41750-12
20	Spacer	43149		NOT SHOWN	
21	Roll Pin (2 req'd)	Y178-1		Wrench (furnished with models	
22	Cylinder (includes item 21)	43152		8479-1-() and 8479-2-()	37167
23	Front End Plate	43184		Wrench (furnished with all models)	39785
24	Ball Bearing	42515			

DISASSEMBLY/ASSEMBLY INSTRUCTIONS

⚠ WARNING

Always wear eye protection when operating or performing maintenance on this tool.

Always turn off the air supply and disconnect the air supply hose before installing, removing or adjusting any accessory on this tool or before performing any maintenance on this tool.

NOTICE

- Never apply excessive pressure by a holding device which may cause distortion of a part.
- Apply pressure evenly to parts which have a press fit.
- Apply even pressure to the bearing race that will be press fitted to the mating part.
- Use correct tools and fixtures when servicing this tool.
- Don't damage "O" rings when servicing this tool.
- Use only genuine ARO replacement parts for this tool. When ordering, specify part number, description, tool model number and serial number.

RIGHT-ANGLE DISASSEMBLY

- Remove lock nut (33). Remove shaft and components.
- Remove nut (27), gear (28) and bearing (29).
- Remove collet nut (35) and collet (34).

RIGHT-ANGLE ASSEMBLY

- Lubricate bearing (29) with ARO 33153 grease.
- Press bearing (29) onto shaft (30 or 31).
- Assemble gear (28) and nut (27) to shaft. Tighten to 15 – 18 ft lbs.
- Assemble seal (32) to lock nut (33). NOTE: Press seal to a depth of .125" ±.015.
- Assemble lock nut (33), with seal (32), to shaft.
- Lubricate bearing in housing and gear with ARO 33153 grease.
- Assemble shaft and components to housing and secure with lock nut (33).
- Assemble collet (34) to shaft and secure with collet nut (35).

MOTOR DISASSEMBLY

- Remove head section. Remove motor from housing.
- Remove gear (25) from rotor.
- Tap threaded end of rotor with a soft face hammer; motor will come apart. NOTE: Bearings are light press fit in end plates and press fit on rotor.
- NOTE: Screw (13) is assembled to rotor with a hard drying adhesive and should not be disassembled unless it is necessary to replace a worn part.

MOTOR ASSEMBLY

- Assemble wavy spring (16) to end plate and assemble end plate to rotor (19).
- Lubricate bearing (15) with ARO 33153 grease.
- Press bearing (15) on rotor and into end plate (17). NOTE: Press on inner race of bearing. Assemble with shielded side out. Outside face of inner race must be flush with end of rotor.
- Assemble washer (14) and screw (13) to rotor using a good grade of thread adhesive.
- Coat rotor blades (18) with ARO 29665 spindle oil and assemble to rotor slots – straight side out.
- Coat i.d. of cylinder (22) with ARO 29665 spindle oil and assemble over rotor. NOTE: Air inlet holes in end of cylinder must be aligned with air inlet holes in end plate (17).
- Lubricate bearing (24) with ARO 33153 grease.
- Assemble bearing (24) to end plate (23), shielded side out.
- Assemble spacer (20) and end plate (23), with bearing, to rotor. NOTE: Press on inner race of bearing. Be sure rotor turns without binding.
- Assemble gear (25) to rotor. Lubricate gear with ARO 33153 grease.
- Assemble motor to housing.

THROTTLE DISASSEMBLY

- Remove screw (12), washer (11), spring (10) and valve (8) with "O" ring (9).
- Remove inlet adapter (1) and air diffuser (2).
- To remove lock nut (6), remove retaining ring (7).
- To remove lever (4), remove roll pin (3).

THROTTLE ASSEMBLY

- Lubricate and assemble "O" ring (9) to valve stem (8).
- Assemble valve stem (8) and spring (10) to head and secure with washer (11) and screw (12).
- Assemble lock nut (6) to head. Secure with retaining ring (7).
- Assemble air diffuser (2) and inlet adapter (1) to head.
- Assemble lever (4) to head, securing with roll pin (3).

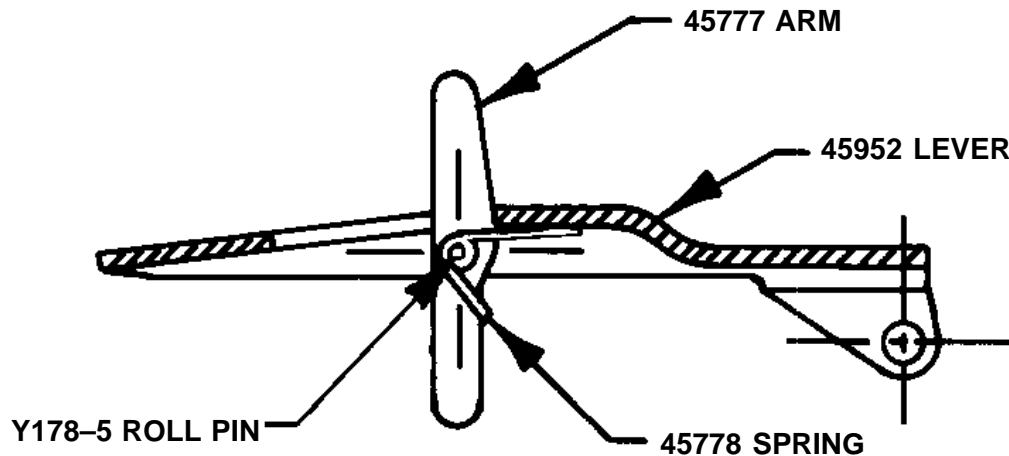
45953 LOCK-OFF LEVER ASSEMBLY

(ATP-2)



PN 49999-324

Free Manuals Download Website

<http://myh66.com>

<http://usermanuals.us>

<http://www.somanuals.com>

<http://www.4manuals.cc>

<http://www.manual-lib.com>

<http://www.404manual.com>

<http://www.luxmanual.com>

<http://aubethermostatmanual.com>

Golf course search by state

<http://golfingnear.com>

Email search by domain

<http://emailbydomain.com>

Auto manuals search

<http://auto.somanuals.com>

TV manuals search

<http://tv.somanuals.com>