



Form 10590149
Edition 2
September 2005

HOISTS

Series 7790-A & 7792-A

Operator's Manual



Save These Instructions



Safety Information

Operating Precautions

To aid the operator's understanding of proper and safe use of hoists, the publication "OVERHEAD HOISTS", ANSI B30.16-1981, can be purchased from:

American Standards Institute, Inc.
1430 Broadway
New York, New York 10018

- Do not use the hoist described in this manual to lift or transport humans.
- Never try to lift a load heavier than the rated capacity of the hoist.
- Operate hoist with caution. Operator should have a good attitude toward safety.

- Always follow "proper operating" instructions given in this manual.
- Allow only people who have received training in "proper hoist operation" to operate hoists.
- Follow all operating and routine inspection procedures prescribed in this manual.
- Operator of hoist shall operate hoist in a position that will not be hazardous to his health.
- Do not attempt to operate hoist if it is not operating properly.
- Before operating hoist, all routine inspection and lubrication procedures should be completed.

Lubrication

Routine Lubrication Requirements

Lack of or an excessive amount of lubrication will affect the performance and life of this tool Use only recommended lubricants at below time intervals:

EVERY 8 HOURS OF TOOL OPERATION -fill lubricator reservoir with spindle oil (29665). If an in line or air line lubricator is not used, fill oil reservoir of built-in oiler of hoist head.

EVERY 80 HOURS OF HOIST OPERATION - Grease fittings in lower BLOCK HOOK ASSEMBLY and TROLLEY WHEELS with NLGI #1 grease 33153).

EVERY 160 HOURS OF HOIST OPERATION - Fill oil reservoir in GEAR CHAMBER with "EP" gear oil (40164). Coat load chain of hoist with EP" gear oil (40164).

Air Supply Requirements

For maximum operating efficiency, the following air supply specifications should be maintained to this hoist.:

- AIR PRESSURE - 90 PSIG (6 bar)
- AIR FILTRATION - 50 micron
- LUBRICATED AIR SUPPLY
- HOSE SIZE - 1/2" (13 mm) I.D.

An ARO model 128241-800 airline FILTER/REGULATOR/LUBRICATOR (F-R-L) is recommended to maintain the above air supply specifications.

Recommended Lubricants

After disassembly is complete all parts, except sealed or shielded bearings, should be washed with solvent. To relubricate parts, or for routine lubrication, use the following recommended lubricants:

Where Used	ARO Part#	Description
Air Motor	29665	1 qt. Spindle Oil
Gears and Bearings	33153	5 lb. "EP" - NLGI #1 Grease
"O" Rings & Lip Seals	36460	4 oz. Stringy Lubricant
Gearing Oil Chamber	40164	1 qt. "EP" Gear Oil

Operation

Suspending Hoist Adjusting Brake

Always select an overhead support capable of supporting combined weight of hoist, trolley, and hoist's load capacity.

Hook Suspended Models

- Upper hook should be firmly seated in center of hook saddle and that safety latch is closed.
- 43059 secondary support cable is recommended.

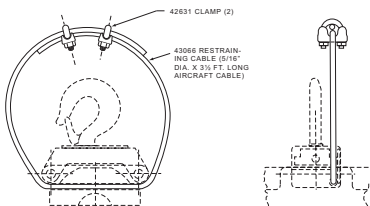

(Dwg.)

Trolley Suspended Models

- Be sure TROLLEY WHEELS are compatible with beam being used.
- Width between outside of TROLLEY WHEELS should be the width of beam flange + 1/2".
- If 43111 - 90' ADAPTER is used, mount to hoist before attempting to install trolley.
- Width is varied by using SPACERS between the hoist body and the trolley SIDE PLATES.

- Insert an equal number of SPACERS on each inside of the trolley SIDE PLATES until beam flange + 1/2" measurement is reached. SIDE PLATES must be vertical.
- Insert SHAFTS (43009) through hoist, or adapter if used, and trolley SIDE PLATES.
- Position trolley and hoist assembly on beam.
- Put an equal number of SPACERS on each end of SHAFTS (43009) with lock washer being last.
- Tighten nuts on SHAFTS (43009). SHAFTS should extend all the way through the NUTS.
- Move trolley over entire length of beam. If it appears the trolley SIDE PLATES can be moved closer together and freedom of movement will be maintained, remove an equal number of SPACERS from inside the SIDE PLATES and assemble these SPACERS to the outside of the SIDE PLATES.
- Tighten NUTS to 25-30 ft. lbs.
- Connect sufficient length of air hose to reach the maximum travel distance of trolley.

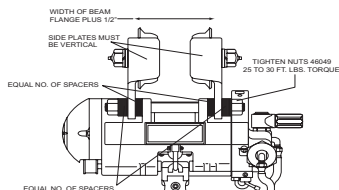

Adjusting Brake

- Properly attach rated load of hoist to load chain hook.
- Slowly raise load to 6" height above floor by slowly pulling pull chain handle or depressing pendent control.
- Release pull chain handle or pendent control.
- If load starts to lower, tighten brake adjustment by turning counter-clockwise until load stops lowering.
- Do not over tighten brake. If brake it too tight, the lifting and lowering of load will be erratic, not smooth.

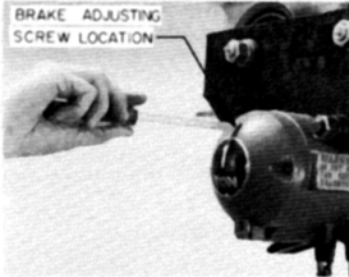

Setting Maximum Up and Down Speeds

- Never attempt to adjust speed regulator valves on spark resistant hoists. They are preset by ARO.
- Attach rated load of hoist to load chain hook.
- Turn speed regulator valves clockwise until they stop. This is lowest setting.
- Lift load by pulling pull chain or depressing pendent control completely. As load is being lifted, turn up speed regulator valve counter-clockwise to set the hoist at the desired maximum "lift" speed.
- Lower load by pulling pull chain or depressing pendent control completely. As load is lowered, turn "DN" speed regulator valve counter-clockwise to set the hoist at the desired maximum "lowering" speed.
- The pull chain or pendent control is used as the variable control of lift and lowering speeds up to the maximum speed set by the speed regulator valves.

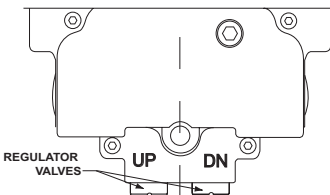

Chain Stop

- Do not operate hoist unless chain stop is properly attached to hoist load chain.
- Do not use chain stop to limit the distance the load is to be lifted. The function of the chain stop is to keep the lower hook components from striking the control arm should an over-run condition ever occur.

Installation instructions should be completed before attempting to operate the hoist.

Before Securing Load to Lift Chain

- Perform routine inspection and lubrication procedures.

Securing Load to Lift Chain

- DO NOT WRAP LOAD CHAIN AROUND LOAD. Approved slings or other approved devices should be used to provide adequate single point securing of load to

hoist load chain hook. Be sure safety latch on hook is closed.

- Be sure load chain is not twisted or kinked.
- Hoist should be centered over the load. Always secure load chain hook to center of load. Never lift a load from the side or end.
- Allow only a sufficient amount of slack in load chain to permit attaching hook to load.

Lifting and Lowering Load

1. Pull (pull chain models) or depress (pendent control models) controls slowly to eliminate abrupt, jerky operation.
2. Take up slack in chain slowly.
3. Speed of load lifting can be controlled by the pull chain or pendent control. Pulling the chain further or depressing the pendent further will result in a faster speed.

Load Chain Removal

- Drive out roll pin (106) and remove clevis from chain.
- If a chain basket is being used with hoist, remove chain stop from end of chain.
- 2-Ton models with double reeved chain; remove retaining ring (110) and pin (111) from anchor bracket (112).
- Pull down on one end of control arm (68) to release brake and pull chain from housing.

Load Chain Installation

- A new chain should never be used on a worn pocketwheel. Replace chain and pocketwheel as a pair.
- Place hoist in vise and clamp on upper hook mount.
- Remove housing cap (95), brake spring (94) and brake shoes (92).
- Turn brake wheel (93) by hand to rotate pocketwheel while carefully feeding chain thru chain guide and around pocketwheel (64).
- Pull sufficient chain thru housing to allow end link to be attached to anchor lug on housing.



CAUTION

Chain must be positioned around pocketwheel so weld on the standing links face outward from pocketwheel - see illustration.

- End link of chain must also be positioned properly to permit attaching to anchor lug on housing without twisting of chain.



WARNING

Do not attempt to feed chain over pocketwheel by air power as chain will be pulled thru housing at a very fast rate.

- Attach other end of chain to lower hook (or anchor bracket on 2-Ton models).

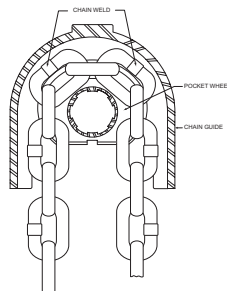

Routine Inspection

The type of application for a hoist varies so greatly it is impractical to recommend an exact time-table for inspection of the hoist. Where hoist is subjected to continuous operation with capacity loads, it is recommended the unit be inspected twice a week. If the application is less demanding, the unit should be inspected twice a month. In general, the frequency of inspection should be determined by the severity of the application. The user of a hoist should be guided by any existing federal, state or local regulations governing the use, testing or inspection of the hoist.

If any damage or malfunction is evident do not operate hoist until all repairs have been made and hoist tested for proper operation.

The following points and areas are recommended for inspection:

Load Chain and Anchor Points

- Visually check for nicked, gouged, twisted, bent, corroded, rusted, worn or broken links. Check ends of chain where chain is anchored to hoist frame and where chain is fastened to lower hook. Check anchors and pins.
- Check chain elongation with a vernier caliper as shown. IF VISUAL CHECK REVEALS NO DEFECTS, PROCEED AS FOLLOWS:
LAY USED CHAIN ON FLAT SURFACE AND MEASURE BETWEEN FIVE (5) LINKS AS SHOWN. MEASUREMENT SHOULD BE TAKEN ON PORTION OF CHAIN WHICH HAS MOST PASSED OVER THE POCKET WHEEL. IF MEASUREMENT TAKEN IS (SEE TABLE) INCHES OR MORE, CHAIN SHOULD BE REPLACED.

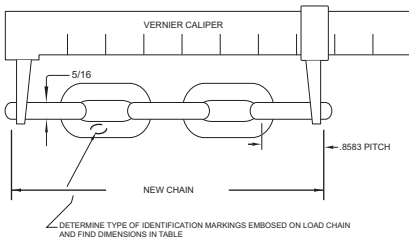

IT IS NOT INFERRED that a chain is safe prior to the occurrence of elongation of the chain. It is inferred ONLY, that when said elongation is evident, the chain must be replaced. Other factors, such as those mentioned as a visual check, may render chain unsafe long before replacement due to elongation is necessary. NOTE: New chain should never be used on a worn pocketwheel, replace chain and pocketwheel as a pair. Chain should also be replaced when replacing brake shoes.

IDENTIFICATIONS MARKINGS	NEW CHAIN MEASUREMENT	REPLACE CHAIN
★ or (ARO)	4.291	4.366
(OC2)	4.340	4.415

Hooks and Suspension

- Check upper and lower hooks and related parts for bent, worn, cracked, broken or otherwise damaged parts.
- On trolley suspended models, check conditions of trolley parts, trolley adapter and related parts.

- Check for loose bolts, nuts, or rivets.

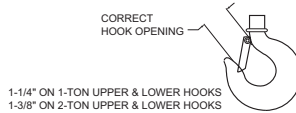

Brake

- Check brake operation - see Adjusting Brake, page 2.
- Check brake linings and components. NOTE: When replacement of brake shoes is indicated, they must be replaced as a pair. Also replace chain at this time.

Gears, Bearings and Pocketwheel

- Check teeth on gears and motor shaft pinion.
- Check pockets of pocketwheel.
- Check bearings for noisy operation indicating wear.

Throttle Valve Head and Gears

- Check valve body, valves, and "O" rings on valves.
- Check gear teeth and bearings.

Air Motor

- Check end faces of rotor for roughness and blade slots for wear or burrs. A new blade should slide in and out of slots without binding.
- Check blades for wear, warpage or other damage.
- Check cylinder bore diameter for rough circular grooves from scoring. A badly scored cylinder cannot be restored by honing since it will only enlarge bore diameter, widening seal point between rotor and cylinder, hindering free exhaust of air and result in loss of speed and power.
- Check end plates for wear or scoring. Check bearings.
- Follow all operating and routine inspection procedures prescribed in this manual.
- Disconnect air supply from hoist before performing maintenance or service procedures.
- Never apply excessive pressure by a holding device which may cause distortion of a part.
- Apply pressure evenly to parts which have a press fit.
- Apply even pressure to the bearing race that will be press fitted to the mating part.
- Use correct tools and fixtures when servicing this tool.
- Don't damage "O" rings when servicing tool.
- Use only genuine ARO replacement parts for this tool. When ordering specify part number, description, tool model number and serial number.

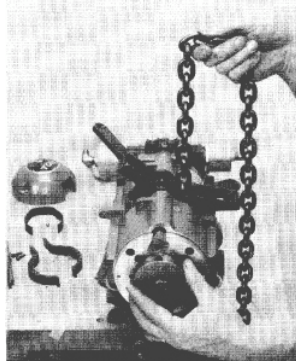

Maintenance

Dissassembly

Head Disassembly

To remove head section from housing without disassembling head components, remove head with control rod (59) attached to gear (25). To accomplish this -

- Remove two screws (96) and housing cap (95).
- Drive out roll pin (61) and remove brake block (60).
- Drive out roll pin (69) from control arm (68).
- Remove six screws (22) and washers (23).
- Remove head section and control rod from housing as one unit.

To disassemble head components without removing head section from hoist:

- Remove two screws (96) and housing cap (95).
- Drive out roll pin (69) from control arm (68).
- Drive out roll pin (26) from gear (25) and drive control rod (59) back thru gear (25) and remove gear.
- Remove adapters (19), valves (17) and (29) and valve body (15).
- Remove set screws (24) and regulator valves (28).



do not attempt to adjust or remove regulator valves (28) from spark-resistant hoist models - these valves are pre-set at factory.

- Remove adapter (1) and screen (2).
- Remove retaining ring (4), swivel (3), swivel body (6) and screen (8).
- Remove two screws (9), washers (10), exhaust deflector (11), screen (12) and muffler filler (13).

STEP 1 - POSITION HOIST SO YOU ARE FACING END WITH AIR INLET. WITH VALVE PARTS AND GEAR [25] REMOVED, PLACE VALVE BODY IN VALVE OPENING. INSERT FINGER IN EACH END OF VALVE OPENING AND ALIGN END OF VALVE BODY WITH ENDS OF BUSHING.
NOTE: VALVE BODY MUST BE INSTALLED WITH IDENTIFICATION MARK AS SHOWN.

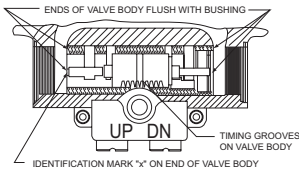

STEP 2 - WITH BRAKE RELEASE BLOCK ASSEMBLED TO CONTROL ROD, INSERT ROD THROUGH BRAKE END OF HOUSING, THROUGH CONTROL ARM [68] AND ON THROUGH HOUSING STOPPING BEFORE ROD PROTRUDES FROM HEAD. ASSEMBLE GEAR [25] TO HEAD ALIGNING CENTER TOOTH OF GEAR BETWEEN TWO GROOVE MARKINGS ON THE VALVE BODY AS SHOWN. ASSEMBLE CONTROL ROD THROUGH GEAR AND SECURE WITH ROLL PIN [26]. SECURE CONTROL ARM TO ROD WITH ROLL PIN [69].

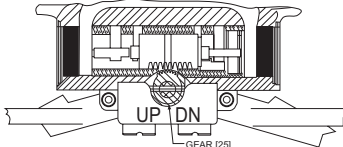

STEP 3 - ASSEMBLE O-RINGS [16] TO VALVES [17] AND [19] AND ASSEMBLE VALVES INTO HEAD AS SHOWN. ASSEMBLE O-RINGS [18] TO ADAPTERS [29] AND O-RINGS [20] TO VALVE CAPS [21] AND ASSEMBLE TO HEAD.

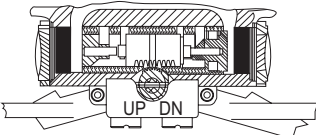

NOTE: When reassembling head to housing a new Gasket (31) must be installed. Tighten Screws (22) to approximately 60 in.-lbs. torque. When tightening these screws it is recommended that an air line be attached to the air inlet and the hoist operated to insure that no binding of the motor occurs. Tighten screws alternately and gradually until desired torque is reached without binding of motor. Lubricate all O-Rings with O-Ring lube (36460) before assembling. Insure O-Ring (32) is properly positioned in head.

- Assemble valve body (15) into head - see "Timing of Head", this page.
- Assemble o-rings (27) to regulator valves (28).
- Assemble regulator valves (28) to head and secure with set screws (24). NOTE: groove in regulator valve must be aligned to accept set screw. See setting hoist speed, page 2.
- Assemble muffler filler (13), screen (12) and exhaust deflector (11) to head and secure with washers (10) and screws (9).
- Clean and assemble screen (8) to head.
- Assemble o-rings (5) and (7) to swivel body (6) and assemble body to head.
- Assemble swivel (3) to swivel body and secure with retaining ring (4).
- Clean and assemble screen (2) and inlet adapter (1) to swivel.
- Fill oil reservoir in head with spindle oil 29665.

Pendent Control Disassembly

- Remove pendent hoses from fittings (156) and (165).
- Remove adapter (166) from head releasing strain cable.
- Remove screws (168), springs (170) and valves (171).

Pendent Control Assembly

- Lubricate o-rings (172) and assemble to valves (171).
- Assemble valves (171) and springs (170) to handle.
- Lubricate o-rings (169) and assemble to screws (168).
- Assemble screws (168) to handle securing valve components.

Pendent Cylinder Disassembly

- Unthread cylinder (157) from adapter (163).

Pendent Cylinder Assembly

- Assemble piston rod (160) to piston (159).
- Lubricate and assemble o-ring (158) to piston (159).
- Lubricate and assemble o-rings (162) and (164) to adapter (163).

Motor Disassembly

- Remove head section - see "Head Disassembly".
- Remove motor from housing.
- Remove retaining ring (36); motor assembly will come apart.

Motor Assembly

- Lubricate bearings (37) with NLGI #1 "EP" grease (33153) and assemble bearings to end plate (38) and (43) - shielded side of bearing facing out.
- Assemble end plate (43) to spindle (45) and slide up to shoulder of spindle.
- Assemble key (44) to key slot in spindle (45).
- Assemble rotor (41) over spindle aligning key way and key (44).
- Assemble cylinder (39) over rotor (41) and insert blades (42) into blade slots of rotor - straight side of blade out.
- Assemble end plate (38) to spindle and align hole in end plate with roll pin (40).
- Secure assembled parts to spindle with retaining ring (36).

- Assemble motor to housing.
- Lubricate and assemble o-rings (35) into counterbore of end plate (38).
- Assemble new gasket (31) and head to housing.

Brake and Gearing Disassembly

- Remove two screws (96) and housing cap (95).
- Carefully slide brake spring (94) part way off brake shoes (92) and using brake spring spreader (33541), remove brake spring (94).



remove brake spring (94) with due regard for safety as spring is assembled with considerable tension.

- Remove brake shoes (92) and steel balls (91).
- Align hole in brake wheel (93) with hole in end plate (89) and insert a punch or pin thru holes to secure brake wheel.

- Remove cotter pin (74), nut (99) and washer (100).
- Remove brake wheel (93).
- Remove roll pin (61) and brake block (60).
- Remove four screws (103) and washers (104).
- Place blade type screwdrivers, or similar tool, at opposite sides behind edge of end plate (89) and pry out on end plate to remove from housing.
- Remove gearing assembly.
- Remove retaining rings (70) and (82).
- Push on threaded end of shaft (72) and remove out opposite end of gear carrier (75).
- Remove bearing (80), spacer (79) and shafts (78), releasing gears (77) and bearing races (76).
- Remove retaining ring (83) and bearing (81).
- Remove four shoulder screws (101) and washers (102) and fixed ring gear (84).
- Remove seal (88) for replacement only.

Assembly

Brake and Gearing Assembly

- Lubricate and assemble six o-rings (86) into counterbores of fixed ring gear (84).
- Assemble seal (88) to end plate (89) - lip of seal facing out.
- Assemble wave washer (87) and end plate (89) to fixed ring gear (84) and secure with four washers (102) and shoulder screws (101).
- Assemble gears (77), bearing races (76) and shafts (78) to gear carrier (75).
- Assemble spacer (79) to gear carrier aligning spacer with notched ends of shafts (78).
- Lubricate bearings (73) and (80) with NLGI #1 "EP" grease (33153) and assemble to gear carrier (75).
- Lubricate bearing (71) with NLGI #1 "EP" grease (33153) and assemble to shaft (72).
- Assemble shaft (72) to gear carrier (75) and secure with retaining ring (70).

IMPORTANT: punch marks on gears (77) indicating aligned teeth must be held in alignment with punch marks on gear carrier (75) when shaft (72) to assembled to gear carrier.

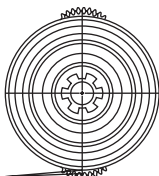

PUNCH MARKS ON GEARS AND PUNCH MARK ON CARRIER MUST BE IN ALIGNMENT

- Lubricate bearing (81) with NLGI #1 "EP" grease (33153) and assemble to shaft (72).
- Assemble retaining ring (82) and (83) to shaft (72).
- Assuming o-ring (53) and ring gear (55) are assembled to housing (see housing assembly); assemble gearing into ring gear (55).
- Lubricate and assemble o-ring (54) over fixed ring gear (84) and slide up to end plate.
- Assemble fixed ring gear and end plate to gearing and housing. Use reasonable caution so as not to damage seal (88) in end plate.
- Secure end plate and components to housing with washers (104) and screws (103).
- Assemble brake wheel (93) to shaft (72) and secure with washer (100), nut (99) and cotter pin (74).

- Assemble control rod (59) thru housing, hangers (62) and control arm (68).
- Secure control arm (68) to rod with roll pin (69).
- Assemble brake block (60) and roll pin (61) to control arm (59).
- Assemble screw (90), balls (91), brake shoes (92) and brake spring (94).
- Assemble housing cap (95) and secure with two screws (96). See brake adjustment, page 2.
- Fill gearing oil chamber with 6 to 7 ounces (to lower plug hole level) "EP" gear oil (40164).

Housing Disassembly

- Remove head, motor and gearing sections.
- Remove screws (67), washers (66) and plate (65).
- Place brass or wood block in pocketwheel cavity to prevent shaft (50) from turning.
- Remove nut (58), washer (57), o-ring (56) and ring gear (55).
- Remove retaining ring (46) from "motor end" of housing.
- Remove shaft (50) with bearing (47).
- Remove pocketwheel (64) and chain guide (63).
- Remove seal (52) for replacement only.

Housing Assembly

- Assemble bearing (47) and retaining ring (46) to "brake end" of housing.
- Assemble chain guide (63) and pocketwheel (64) to housing.

NOTE: part number stamped on face of pocketwheel must face "motor end" of housing.

- Assemble retaining ring (48) and bearing (47) to shaft (50).
- Insert shaft (50) into housing and thru pocketwheel (64) and bearing (47).
- Assemble retaining ring (46) to housing.
- Assemble plate (65), washers (66) and screws (67) to housing.
- Assemble new seal (52) into housing with lip of seal facing out.
- Lubricate and assemble o-ring (53) into groove in housing.
- Assemble ring gear (55), o-ring (56), washer (57) and nut (58).
- Assemble motor, gearing and head sections to hoist.

Upper Hook Disassembly

- Remove nuts (153), washers (152) and bracket (150).
- Drive out roll pin (147) - One-Ton Models. Roll pins (155) and (154) - Two-Ton Models.
- Remove collar (143) and balls (144) - One-Ton Models. Collar (116), thrust bearing (120) and bearing races (119) - Two-Ton Models.

Upper Hook Assembly

Position hook on bracket (150).

Apply a liberal amount of grease to groove of collar (143) and assemble eleven balls (144) to collar.

Slide collar and balls over shank of hook and secure with roll pin (147) - One-Ton Models.

Apply a liberal amount of grease to thrust bearing (120) and assemble thrust races (119) and bearing (120) to shank of hook. Secure with roll pins (154) and (155) - Two-Ton Models.

Assemble bracket (150), shafts (151), washers (152) and nuts (153).



Do not over-tighten nuts (153); tighten 25 to 30 ft. lbs. torque.

Lower Hook Disassembly

1-Ton Models

- Remove snap ring (139).
- Slide snap ring (139) and sleeve (140) up on chain and remove pin (146).
- Separate connector (142) from bucket (145) and remove pin (141).
- Drive out roll pin (147) and remove hook from bucket (145).

2-Ton Models

- Remove bolts (134), washers (133) and shrouds (130).
- Remove bolts (124), (129), washers (125), and spacers (126).
- Remove shaft (128), spacers (127) and sheave (114).
- Drive out roll pins (118) and (117).
- Remove collar (116), thrust bearing (120), bearing races (119) and hook (123).

Lower Hook Assembly

1-Ton Models

- Slide snap ring (139) and sleeve (140) on end of load chain.
- Position end of load chain in connector (142) and secure with pin (141).
- Assemble hook (149) to bucket (145).
- Apply a liberal amount of grease to groove of collar (143) and assemble eleven balls (144) to collar.
- Assemble collar (143) over shank of hook and secure with roll pin (147).
- Assemble bucket (145) to connector (142) and secure with pin (146).
- Slide sleeve (140) over bucket (145) and secure with snap ring (139).

2-Ton Models

- Assemble hook (123) to yoke (121).
- Apply a liberal amount of grease to thrust bearing (120) and assemble bearing races (119) and thrust bearing to collar (116).
- Assemble collar (116) over shank of hook and secure with roll pins (117) and (118).
- Lubricate roller bearing of sheave (114) and assemble bearing race (115) to sheave.
- Assemble spacers (127), sheave (114) and shaft (128) to yoke (121).
- Assemble washers (125) and spacers (126) to bolts (124) and (129) and secure bolts to shaft (128).
- Feed load chain around sheave - with weld of standing links facing out from sheave and attach end of chain to anchor bracket (112) with pin (111) and retaining rings (110).
- Position shrouds (130) on lower hook assembly and secure with washers (133) and bolts (134).

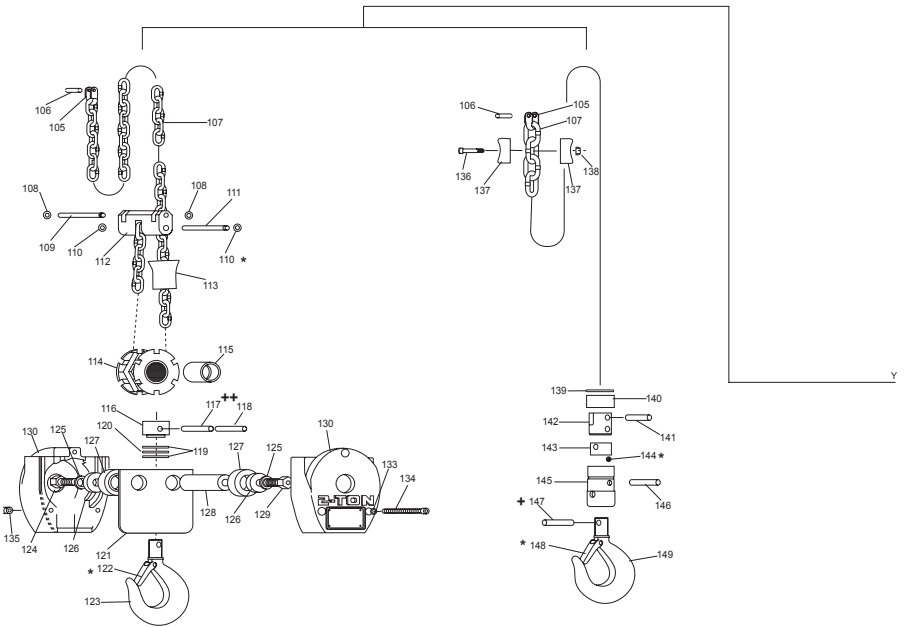
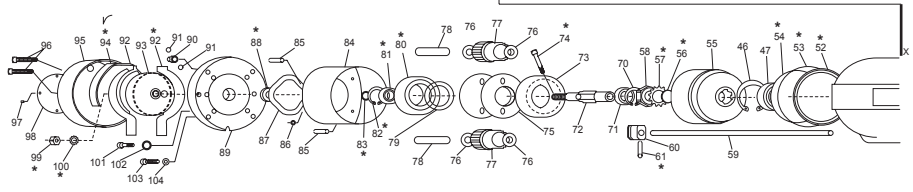
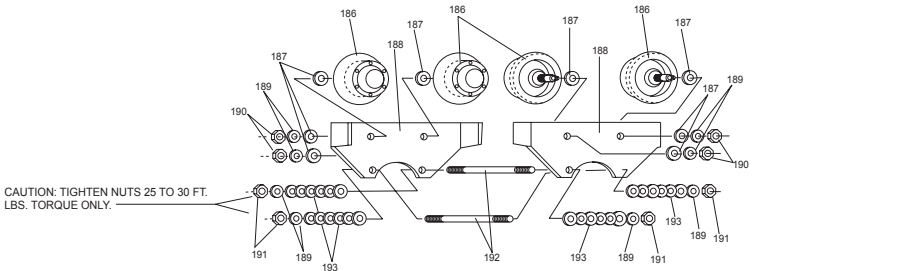

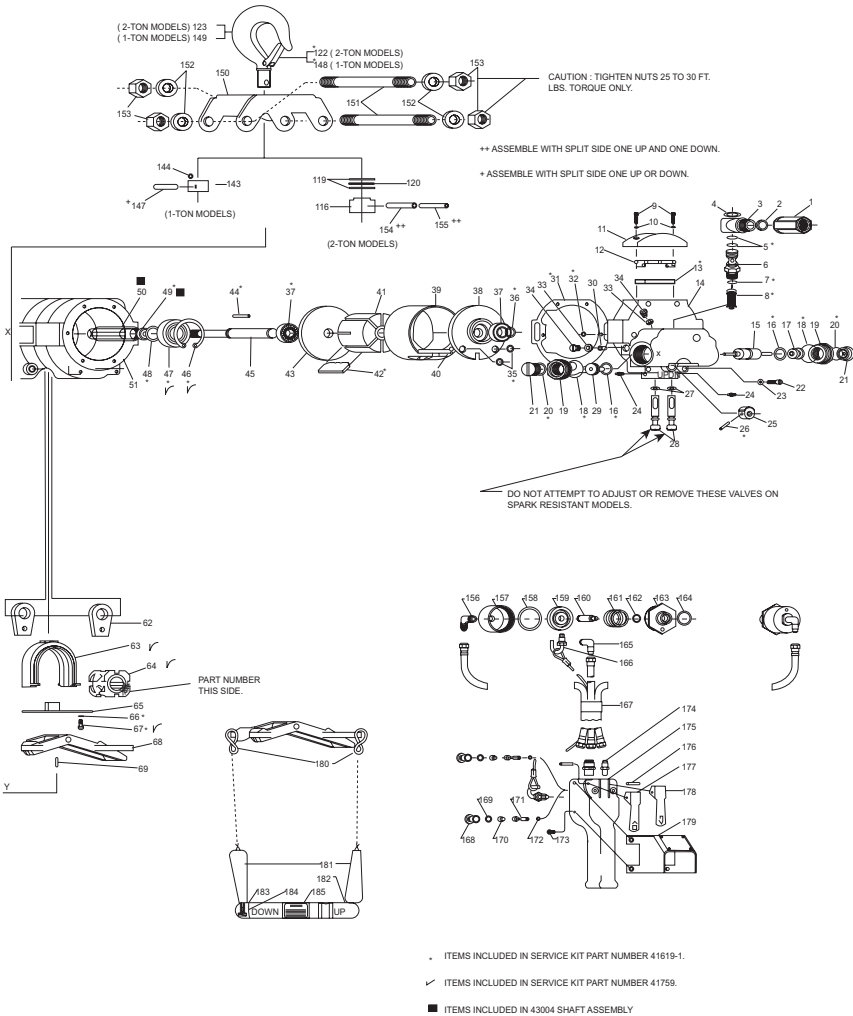

Parts List

Sl. no.	Description	Part no.	Sl. no.	Description	Part no.
	Head Assembly (standard models) includes items 1 thru 21, 24 thru 30, 33 and 34 with adapter (46211)	46126-2		MOTOR ASSEMBLY (includes items 36 thru 45)	42977
			* 36	Retaining Ring	Y145-22
	Head Assembly (spark-resistant models) (includes items 1 thru 19, 24 thru 30, 33, 34 and 59 with adapter 46212)	46126-3	* 37	Bearing (2 req'd)	42086
			38	End Plate	43076
			39	Cylinder (includes item 40)	43130
1	Adapter		40	Roll Pin	Y178-73
	for standard models	46211	41	Rotor	43068
	for spark-resistant models	46212	* 42	Blade (8 req'd)	43067
2	Screen	31648	43	End Plate	42958
3	Swivel	46839	* 44	Key	30934
	SWIVEL KIT (includes items 1 thru 3)		45	Spindle	42959
	for standrad models (includes adapter 46211)	46840	✓ *46	Retaining Ring (2 req'd)	Y147-200
	for spark-resistant models (includes adapter 46212)	46841	✓ *47	Bearing (2 req'd)	92962-ARO
			* 48	Retaining Ring	Y145-25
4	Retaining Ring	Y145-28	* 49	Seal	42149
* 5	"O" Ring (2 req'd)	Y325-115	50	Shaft	42960
6	Swivel Body	33314		SHAFT ASSEMBLY (includes items 49 and 50)	43004
* 7	"O" Ring	Y325-17			
* 8	Screen	46072		Capacity Label (not shown)	
9	Cap Screw (2 req'd)	Y154-53		1000 kg (2200 lb.)	46067-3
10	Washer (2 req'd)	Y14-10		2400 lb.	44198-7
11	Exhaust Deflector	42954		2000 kg (4400 lb)	46067-4
12	Screen	42957		1500 lb.	44198-9
* 13	Muffler Filler	42956		3000 lb.	44198-10
14	Head (includes roller bearing 33239 and three pipe plugs Y227-3, not shown)	46125	51	Housing (includes item 52, pipe plug Y227-2-L, set screw Y29-44 and warning label 43640, not shown)	42996
15	Valve Body	43079			
* 16	"O" Ring (2 req'd)	04614574		Nameplate (not shown)	41596
17	Lift Valve	43080		Drive Screw (4 req'd) (not shown)	Y60-44
* 18	"O" Ring (2 req'd)	Y325-25	✓ *52	Seal	42967
19	Adapter (2 req'd)	40017	* 53	"O" Ring	Y325-46
* 20	"O" Ring (2 req'd) (not required with pendent control models)	Y325-116	* 54	"O" Ring	Y325-155
			55	Ring Gear	42963
21	Valve Cap (2 req'd) (not required with pendent control models)	34026	* 56	"O" Ring	Y325-211
			* 57	Washer	Y117-875
22	Cap Screw (6 req'd)	Y154-54	58	Nut	42964
23	Washer (6 req'd)	Y14-10	59	Control Rod	46121
24	Set Screw (2 req'd)		60	Brake Block	34029
	for standard models	41598	61	Roll Pin	Y178-60
	for spark-resistant models	41627-1	62	Hanger (2 req'd)	43033
25	Gear	34022	✓ 63	Chain Guide	42989
* 26	Roll Pin	Y178-56	✓ 64	Pocket Wheel	42961-ARO
27	"O" Ring (2 req'd)	Y325-111	65	Plate	42990
28	Valve (2 req'd)	43107	* 66	Washer (6 req'd)	Y117-10
29	Descent Valve	43081	✓ *67	Cap Screw (6 req'd)	Y154-52
30	Oilite Casting	33190	68	Control Arm	43133
* 31	Gasket	43008	69	Roll Pin	Y178-55
* 32	"O" Ring	Y325-9	70	Retaining Ring	42975
33	Washer (2 req'd)	31389	71	Bearing	41864
34	Oil Screw (2 req'd)	30747	72	Shaft	43072-1
* 35	"O" Ring (2 req'd)	Y325-12	73	Bearing	40048

Parts List

Sl. no.	Description	Part no.	Sl. no.	Description	Part no.
* 74	Cotter Pin	Y15-32	115	Bearing Race	43041
75	Carrier	42965	116	Collar	43032
76	Bearing Race (4 req'd)	42364	117	Roll Pin	Y178-128
77	Gear (2 req'd)	42971	118	Roll Pin	Y178-117
78	Shaft (2 req'd)	42973	119	Bearing Race (2 req'd)	37391
79	Spacer	42974	120	Thrust Bearing	37392
* 80	Bearing	42968	121	Yoke	43037
* 81	Bearing	Y65-12	* 122	Safety Latch (includes bolt, nut and spring)	420230
* 82	Retaining Ring	Y147-112	123	Hook	
* 83	Retaining Ring	Y145-18		Steel Hook for standard 2 ton models (includes item 122)	43031
	Gearing Assembly (includes items 70 thru 73 and 75 thru 83)	42976		Bronze Hook for 2400 and 3000 lb spark-resistant models (includes item 122)	43083
84	Fixed Ring Gear	42966			
85	Roll Pin (2 req'd)	Y178-101		YOKE AND HOOK ASSEMBLY with steel hook, for standard 2 ton models (includes items 114 thru 123)	43047
86	"O" Ring (6 req'd)	Y325-10			
87	Wave Washer	40041			
* 88	Seal	04565511		YOKE AND HOOK ASSEMBLY with bronze hook, for 2400 and 3000 lb spark-resistant models (includes items 114 thru 123)	43099
89	End Plate (Includes item 88, bracket 42980-1 and roll pin Y178-44, not shown)	43118		LOWER BLOCK ASSEMBLY for standard 2 ton models (includes items 114 thru 129 with steel hook)	43048
	END PLATE and RING GEAR ASSEMBLY (includes items 84 thru 89, 101 and 102)	43003			
90	Screw	37701			
91	Ball (2 req'd)	Y16-10		LOWER BLOCK ASSEMBLY for spark-resistant models (includes items 114 thru 129 with bronze hook)	43101
* 92	Brake Shoe (2 req'd)	42994			
93	Brake Wheel	43071-1			
✓ *94	Brake Spring	42982	124	Bolt	Y5-85-C
95	Housing Cap	42979	125	Washer (2 req'd)	Y14-816
96	Cap Screw (2 req'd)	Y154-54	126	Spacer (2 req'd)	43039
97	Drive Screw (4 req'd)	Y60-43	127	Spacer (2 req'd)	43042
98	Capacity Plate		128	Shaft	43038
	1500 lb.	45278	129	Bolt (includes grease fitting 35323)	40072
	1 ton	41589	130	Shroud (2 req'd)	
	2400 lb.	43116		for standard 2 ton models	43043
	3000 lb.	43050		for 2400 lb models (includes capacity plate 43123 and four drive screws Y60-30, not shown)	43121
	2 ton				
* 99	Nut	Y12-106-C		for 3000 lb models (includes capacity plate 45281 and four drive screws Y60-30, not shown)	45282
* 100	Washer	Y117-616			
101	Shoulder Screw (4 req'd)	42993			
102	Washer (4 req'd)	Y1-416-C	133	Washer (3 req'd)	Y14-416
103	Cap Screw (4 req'd)	Y99-41	134	Cap Screw (3 req'd)	Y99-49
104	Washer (4 req'd)	30997	135	Nut (3 req'd)	Y242-12-B
105	Clevis	34987	136	Cap Screw	Y99-44
106	Roll Pin	Y178-104	137	Chain Stop (2 req'd)	43127
107	Link Chain		138	Nut	Y107-4-Z
	for 1 ton, standard models, 10 ft (3 m) lift	42988-11		Chain Stop Assembly (includes items 136 thru 138)	43128
	for 2400 and 3000 lb, spark-resistant models, 10 ft (3 m) lift	43095-22	139	Snap Ring	42999
108	Retaining Ring (2 req'd)	Y145-8	140	Sleeve	42998
109	Anchor Pin	43020	141	Pin	43702-1
* 110	Retaining Ring (2 req'd)	Y145-2	142	Connector	43028
111	Pin	42970	143	Collar	34321
112	Anchor Bracket	43034	* 144	Ball (11 req'd)	Y16-10
113	Chain Stop	43051-1	145	Bucket	43019
114	Sheave and Bearing	43046	146	Pin	43702-2

Parts List

Sl. no.	Description	Part no.	Sl. no.	Description	Part no.
147	Roll Pin	Y178-122	173	Screw (4 req'd)	Y61-85-C
* 148	Safety Latch (includes bolt, nut and spring)	35023	174	Connector (3 req'd)	Y54-2
149	Hook		175	Handle	43122
	Steel Hook for standard 1 ton models	34337	176	Roll Pin (2 req'd)	y178-58
	Bronze Hook for 1500 lb spark-resistant models	34651	177	Lever (up)	45616-2
			178	Lever (down)	45616-1
	LOWER HOOK ASSEMBLY for 1 ton models (includes items 143 thru 145 and 147 thru 149 with steel hook)	43000	179	Guard Assembly (includes warning plate 44197 and four rivets 45119)	44312
	LOWER HOOK ASSEMBLY for 1500 lb spark-resistant models (includes items 143 thru 145 and 147 thru 149 with bronze hook)	43110		HANDLE ASSEMBLY (includes items 168 thru 179)	43102
				PENDENT CONTROL ASSEMBLY (includes items 156 thru 179)	43106-6
	UPPER HOOK ASSEMBLY for standard 1 ton models (includes items 143, 144 and 147 thru 150 with steel hook)	43002	180	"S" Hook (2 req'd)	37659
			181	Handle (2 req'd)	33268
			182	Control Handle (includes item 185)	44806
	UPPER HOOK ASSEMBLY for 1500 lb spark-resistant models (includes items 143, 144 and 147 thru 150 with bronze hook)	43097	183	Sash Chain (2 req'd)	37657-5
			184	Anchor (2 req'd)	37723
			185	Warning Label	44596
	UPPER HOOK ASSEMBLY for standard 2 ton models (includes items 116, 119, 120, 122, 123, 150, 154 and 155 with steel hook)	43049		PULL CHAIN CONTROL ASSEMBLY (includes items 180 thru 185)	40004-5
			186	Trolley Wheel (4 req'd)	
	UPPER HOOK ASSEMBLY for 2400 and 3000 lb spark-resistant models (includes items 116, 119, 120, 122, 123, 150, 154 and 155 with bronze hook)	43096		for "I" Beam mounting	
				for standard 1 ton models	41015
				for spark-resistant 1 ton models	41015-1
150	Bracket			for standard 2 ton models	40149
	for 1 ton and 1500 lb models	42997		for spark-resistant 2 ton models	40149-1
	for 2 ton, 2400 and 3000 lb models	43030		for "H" Beam mounting (flat tread wheel)	
151	Mounting Rod (2 req'd)	43001		for standard 1 ton models	45376
152	Washer (4 req'd)	46049		for standard 2 ton models	45377
153	Nut (4 req'd)	46049	187	Spacer (8 req'd)	
154	Roll Pin	Y178-128		for 1 ton models	41022
155	Roll Pin	Y178-117		for 2 ton models	Y13-12-C
	CYLINDER ASSEMBLY (2 req'd) (includes items 156 thru 164)	43017	188	Side Plate (2 req'd)	43052
			189	Lock Washer (8 req'd)	Y14-750
156	Elbow	Y54-23	190	Nut (4 req'd)	Y12-12
157	Cylinder	41064-1	191	Nut (4 req'd)	46049
158	"O" Ring	Y325-222	192	Shaft (2 req'd)	43009
159	Piston	41066	193	Washer (84 req'd)	43014
160	Piston Rod	42955	194	Nameplate (not shown)	44081-1
161	Spring	33981	195	Skid Bracket (4 req'd) (not shown)	44618-1
162	"O" Ring	Y325-13	196	Rivet (8 req'd)	Y193-33
163	Adapter	41067		TROLLEY ASSEMBLY	
164	"O" Ring	Y325-116		for spark-resistant models (includes items 186 thru 196)	
165	Elbow	Y54-23			
166	Adapter (2 req'd)	33989		for 1 ton models	7763-BC
167	Hose Assembly (includes hoses and strain cable)	43103-6		for 2 ton models	7764-BC
168	Screw (2 req'd)		37511		for standard models (includes items 186 thru 194)
169	"O" Ring (2 req'd)	Y325-111		for 1 ton models ("I" Beam)	
170	Spring (2 req'd)	32858		for 1 ton models ("H" Beam)	7795-FT
171	Valve (2 req'd)	34757		for 2 ton models ("I" Beam)	7796
172	"O" Ring (2 req'd)	Y325-6		for 2 ton models ("H" Beam)	7796-FT

* SERVICE KIT: includes items marked *

✓ SERVICE KIT: includes items marked ✓

41619-1

41759

Model Identification

Model No.	Upper Mounting	Type Control	Type Load Chain	Lbs. (Kg.) Capacity
7790-A9	Hook Ass'y 43002	Pull Chain	Link	2,200 (1000 Kg)
7790-A11	None *	Pull Chain	Link	
7790-A13	Hook Ass'y 43002	Pendent	Link	
7790-A15	None *	Pendent	Link	
7792-A9	Hook Ass'y 43049	Pull Chain	Link	4,400 (2,000 Kg)
7792-A11	None *	Pull Chain	Link	
7792-A13	Hook Ass'y 43049	Pendent	Link	
7792-A15	None *	Pendent	Link	

Spark Resistant Models

Model No.	Upper Mounting	Type Control	Type Load Chain	Lbs. (Kg.) Capacity
7790-A21	Hook Ass'y 43097	Pull Chain	Link **	1,500 (680 Kg)
7790-A22	None*	Pull Chain	Link **	
7792-A21	Hook Ass'y 43096	Pull Chain	Link **	2,400 (1,089 Kg)
7792-A22	None*	Pull Chain	Link **	
7792-A23	Hook Ass'y 43096	Pull Chain	Link **	3,000 (1,361 Kg)
7792-A24	None*	Pull Chain	Link **	

* FOR TROLLEY MOUNTING - TROLLEY MUST BE ORDERED SEPARATELY

** STAINLESS STEEL LINK CHAIN AND BRONZE HOOKS.

Notes



www.irtools.com

© 2005 Ingersoll-Rand Company

Free Manuals Download Website

<http://myh66.com>

<http://usermanuals.us>

<http://www.somanuals.com>

<http://www.4manuals.cc>

<http://www.manual-lib.com>

<http://www.404manual.com>

<http://www.luxmanual.com>

<http://aubethermostatmanual.com>

Golf course search by state

<http://golfingnear.com>

Email search by domain

<http://emailbydomain.com>

Auto manuals search

<http://auto.somanuals.com>

TV manuals search

<http://tv.somanuals.com>