

Congratulations on your purchase of a high-quality Insignia product. Your TV is designed for reliable and trouble-free performance. Use this guide for initial setup of your TV. See your *User Guide* for more information on using your TV.

### Package contents

- Remote control with battery
- AC adapter
- Vehicle adapter
- AV cable
- *User Guide*
- *Quick Setup Guide*

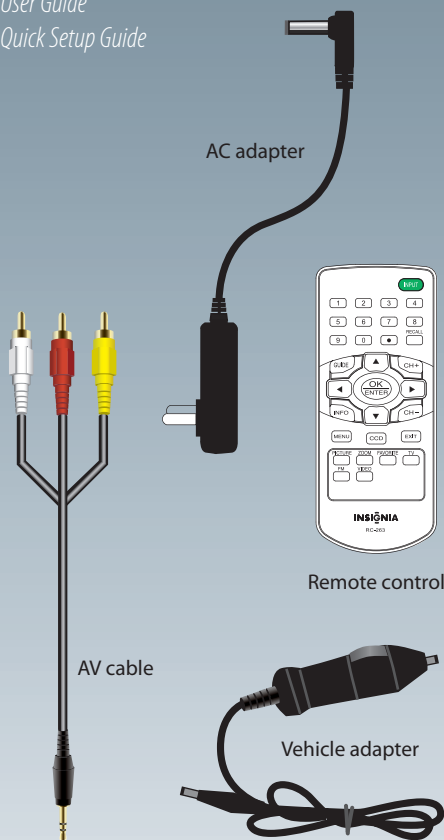

### Step 1 Getting to know your TV and connecting your devices

Check out the front, side, and back panels to familiarize yourself with button controls and connection options.

Connect your devices using the diagram below as a guide. Press **INPUT** on your remote control to switch between devices.

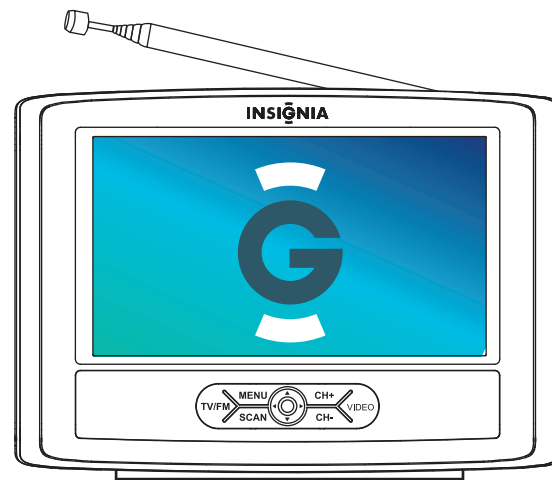

Actual product may vary from image shown.

#### Antenna jack

In TV mode, connect an antenna, cable TV, or satellite TV to this jack. In radio mode, connect the supplied antenna to scan for radio stations.

**Note:** The supplied antenna will be attached with the portable TV when you receive the product. The antenna is detachable. If you want to connect an external antenna, you can detach the antenna and connect other external antenna.

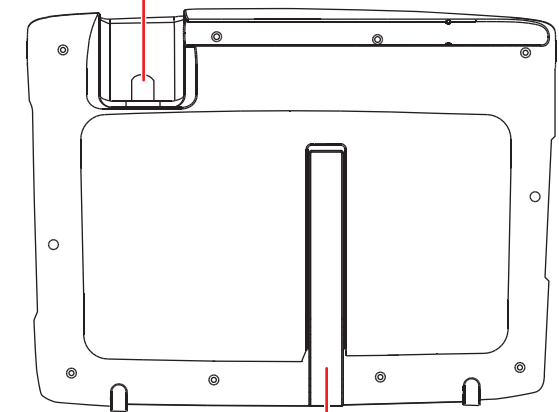

#### Frame Stand

Open up the frame stand and use it for supporting your TV.

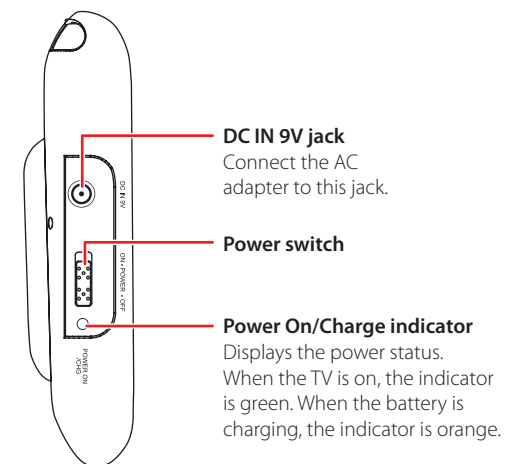
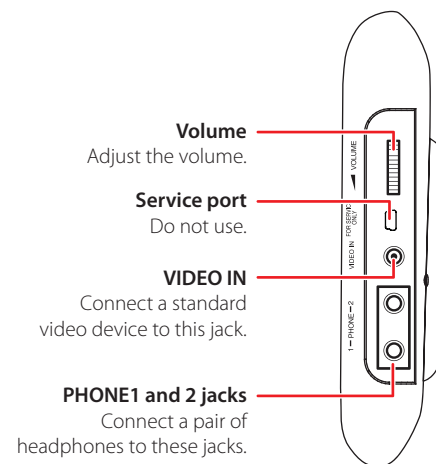

## Step 2 Install the remote control battery

Remove the battery holder from the back of the remote control by inserting a fingernail into the groove and pulling out the holder. Place a CR2025 battery with the + side up on the holder. Insert the holder into the remote control.

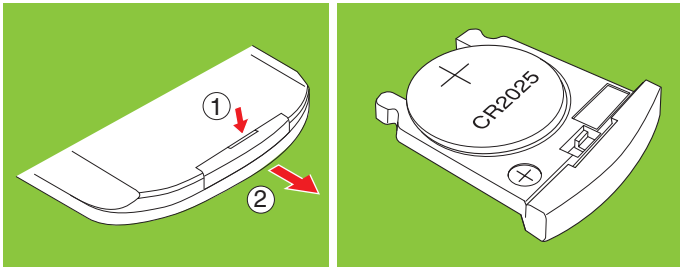

**Note:** The coin-shaped battery is already in the remote control. The first time you use the remote control, remove the plastic sheet from the bottom of the battery to activate the remote.

## Step 3 Connect the AC adapter

Connect the AC adapter into the DC IN jack on the right side of your unit, then connect the AC adapter to a 100-240V power outlet.

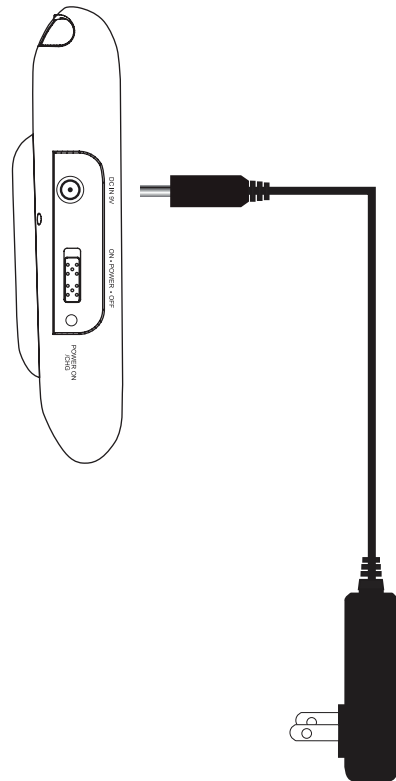

## Step 4 Charging the built-in battery

**Note:** There is no standby mode for this TV, because it runs on a rechargeable battery.

Turn off your TV before charging the battery. Connect the supplied AC adapter. Charging starts, and the **POWER ON/CHG** indicator is red. When the charging is completed, the indicator turns off.

**Note:** On initial use of the TV, charge the battery for 6 hours.

## Step 5 Establish a signal

Make sure that the included rod antenna or a stronger HDTV antenna (not included) is attached to the input at the top of the TV. Extend the antenna rod and move the TV to a location where it can receive the strongest signal, free of obstructions and interference from other devices. Press **TV** on your remote control to ensure you are in TV mode.

## Step 6 Scan for channels

**Note:** See your *User Guide* for more information on connecting your TV directly to cable or satellite service and for scanning for radio stations.

**To scan for channels when the TV signal source is Antenna**

Press **MENU** on the remote control, using the ◀▶ buttons to highlight  (channel icon). The **Channel** menu opens. Press **OK/ENTER** or ▼ to enter the **Channel** menu. Press the ▼▲ buttons to select **Auto Channel Search**, then press **OK/ENTER** or ▶ to enter the **Auto Channel Search** menu. **Start to Scan** is highlighted. Press **OK/ENTER** or ▶ to start the scan.

If the Automatic Channel Search does not locate the channels you were expecting, try moving the TV to a location where you can pick up a stronger signal, then try rerunning the search.

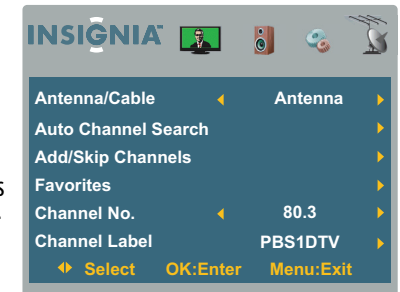

## Free Manuals Download Website

<http://myh66.com>

<http://usermanuals.us>

<http://www.somanuals.com>

<http://www.4manuals.cc>

<http://www.manual-lib.com>

<http://www.404manual.com>

<http://www.luxmanual.com>

<http://aubethermostatmanual.com>

Golf course search by state

<http://golfingnear.com>

Email search by domain

<http://emailbydomain.com>

Auto manuals search

<http://auto.somanuals.com>

TV manuals search

<http://tv.somanuals.com>