

INSIGNIA™

42" 1080p LCD TV
**QUICK SETUP
 GUIDE**
 NS-42L260A13

Thank You
 for purchasing this fine Insignia television.
 We hope you enjoy the quality and reliability
 of this product for years to come.

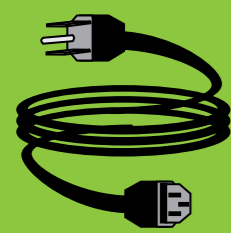

Power cable

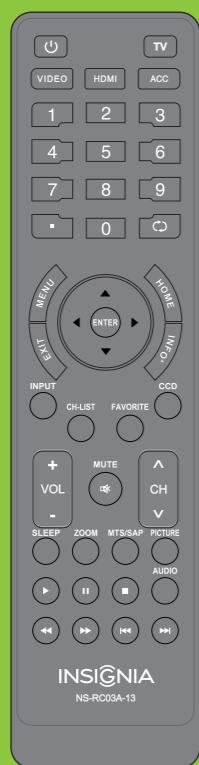

Remote control
 and 2 AAA batteries

M6 screws (12 mm length) (4)

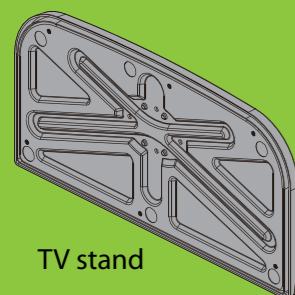

TV stand

WE ARE GOING GREEN!

A copy of your *User Guide* is not provided in the box but is available online.

Go to www.insigniaproducts.com, click **Support & Service**, enter your model number in the **Product Search** field, then click **Search**.



Front features



Power indicator Remote control sensor

Installing the stand

- Carefully place your TV screen face-down on a cushioned, clean surface to protect the screen from damages and scratches.
- Align the tab on the stand with the slot in the stand column on the TV, then slide the stand into the column.
- Secure the stand to the screen with the four provided screws.

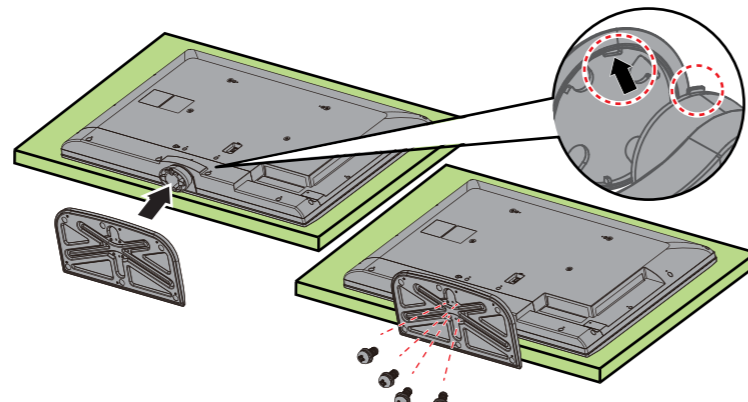

Installing a wall-mount bracket

- Carefully place your TV screen face-down on a cushioned, clean surface to protect the screen from damages and scratches.
- Remove the four screws that secure the stand column, then remove the column.
- Attach the wall-mount bracket to your TV using the mounting holes on the back of your TV. See the instructions that came with the wall-mount bracket for information about how to correctly hang your TV.

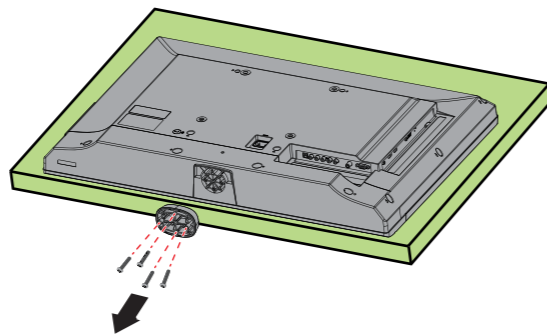

Warning

This apparatus is intended to be supported by a UL Listed wall mount bracket.

Identifying cables

Your TV has several connection types for connecting devices. For the best video quality, connect a device to the best available connection.

Connection type	Video quality	Cable connector
HDMI video/audio	Best	
OR		
Component video and analog audio	Better	
OR		
Composite video and analog audio	Good	

You can use a HDMI 1/DVI jack to connect a DVI device to your TV. You need to attach an HDMI-to-DVI adapter to the end of the HDMI cable that connects to the DVI device's jack.

Connecting a DVD or Blu-ray player, cable box, satellite receiver, camcorder, or game station

Using an HDMI cable (best)

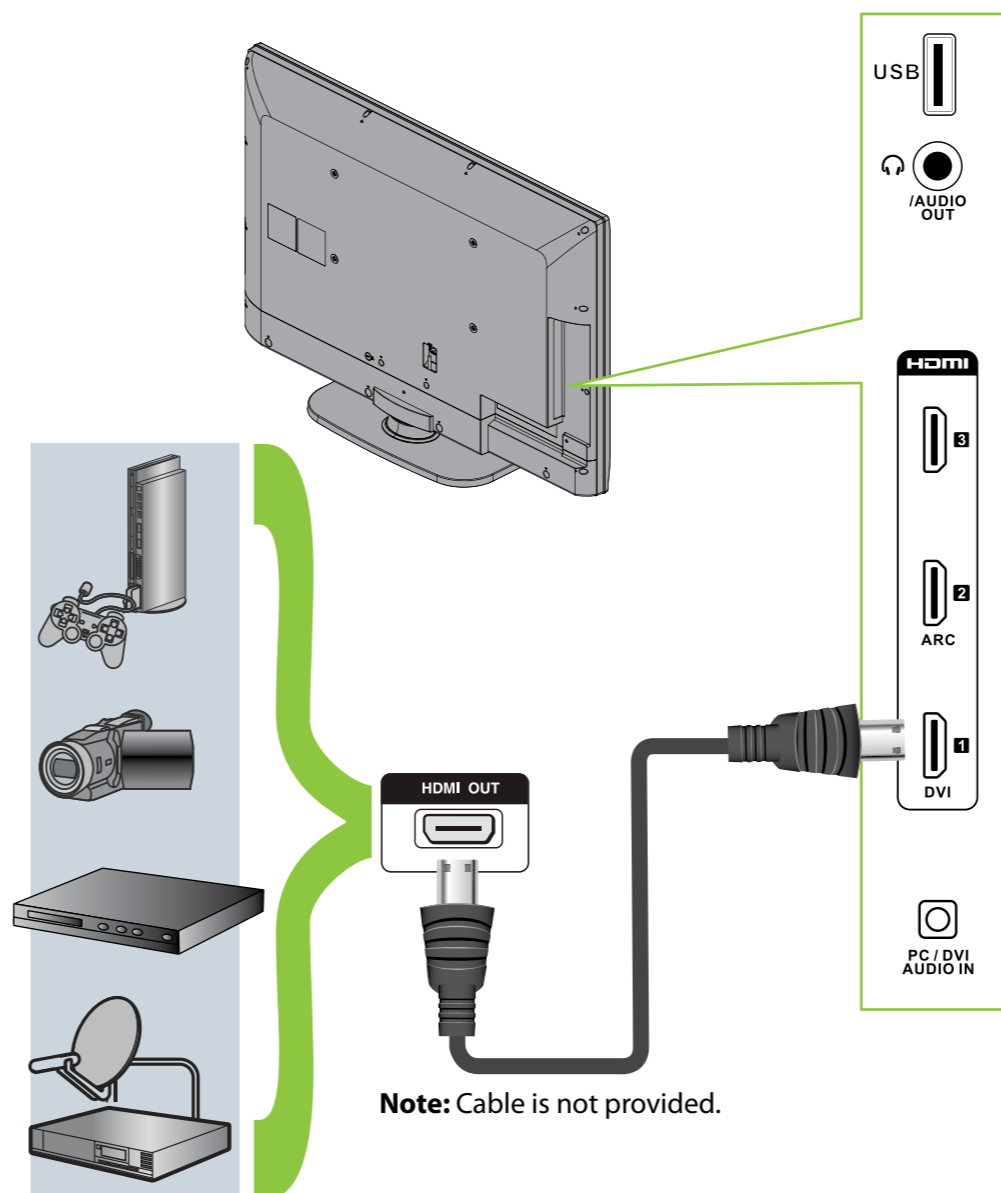

Note: Cable is not provided.

Using component cables (better)

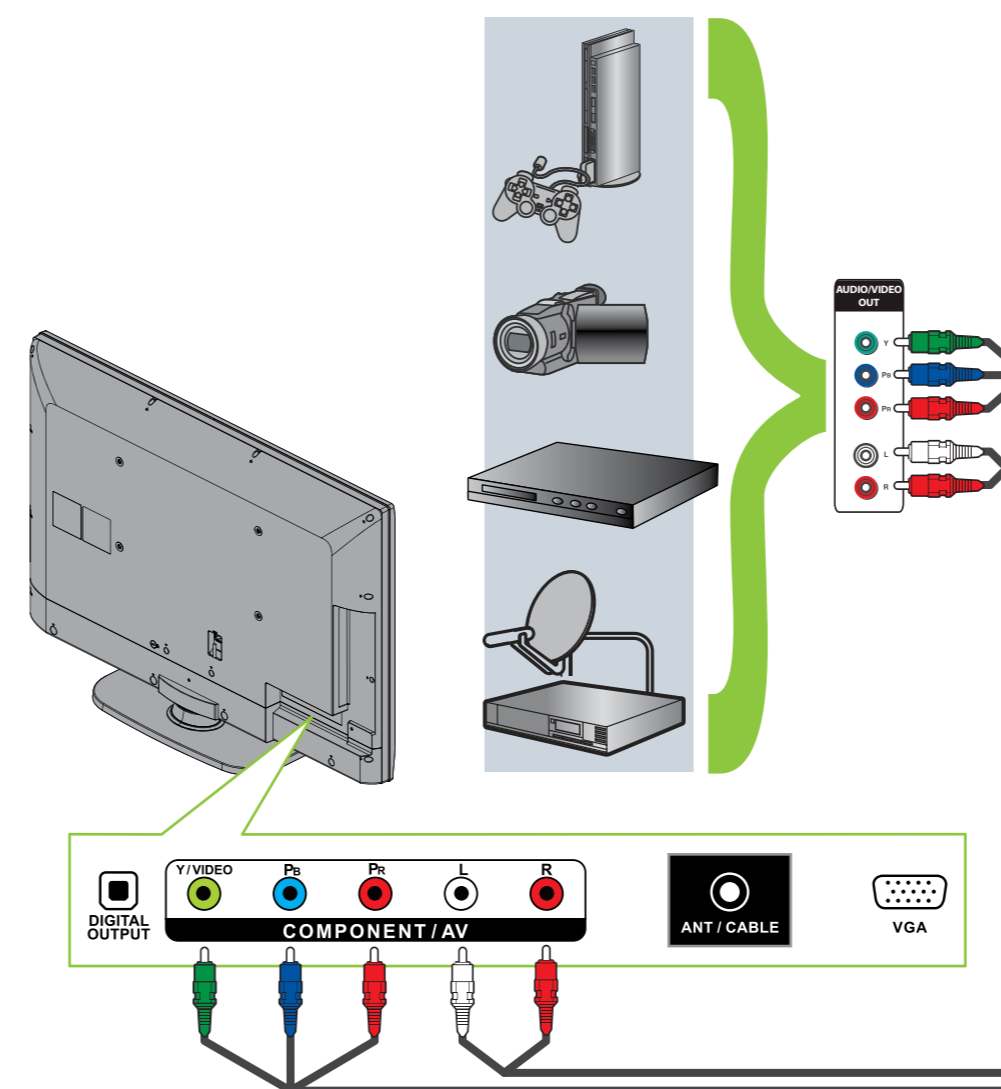

Note: Cables are not provided.

Using an AV cable (good)

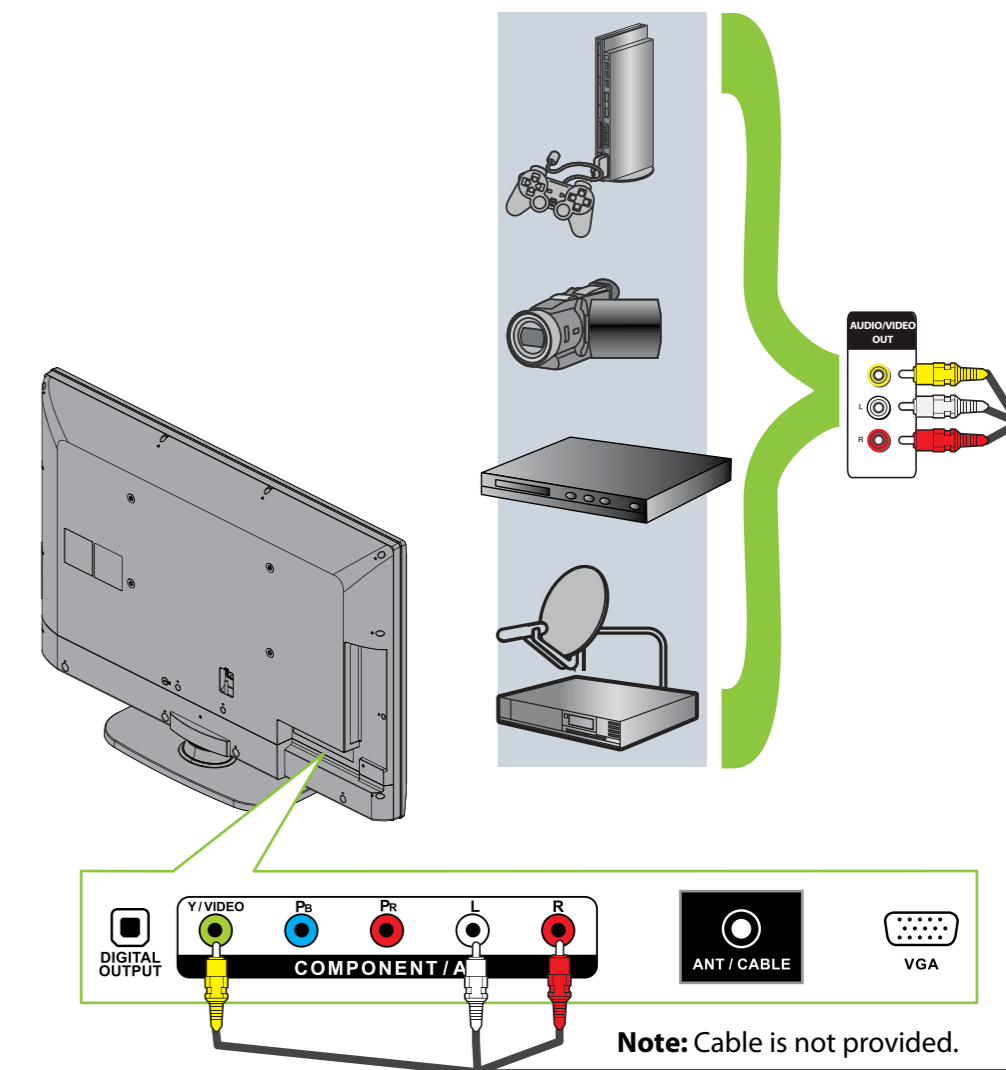

Note: Cable is not provided.

Connecting a home theater system

Using digital audio

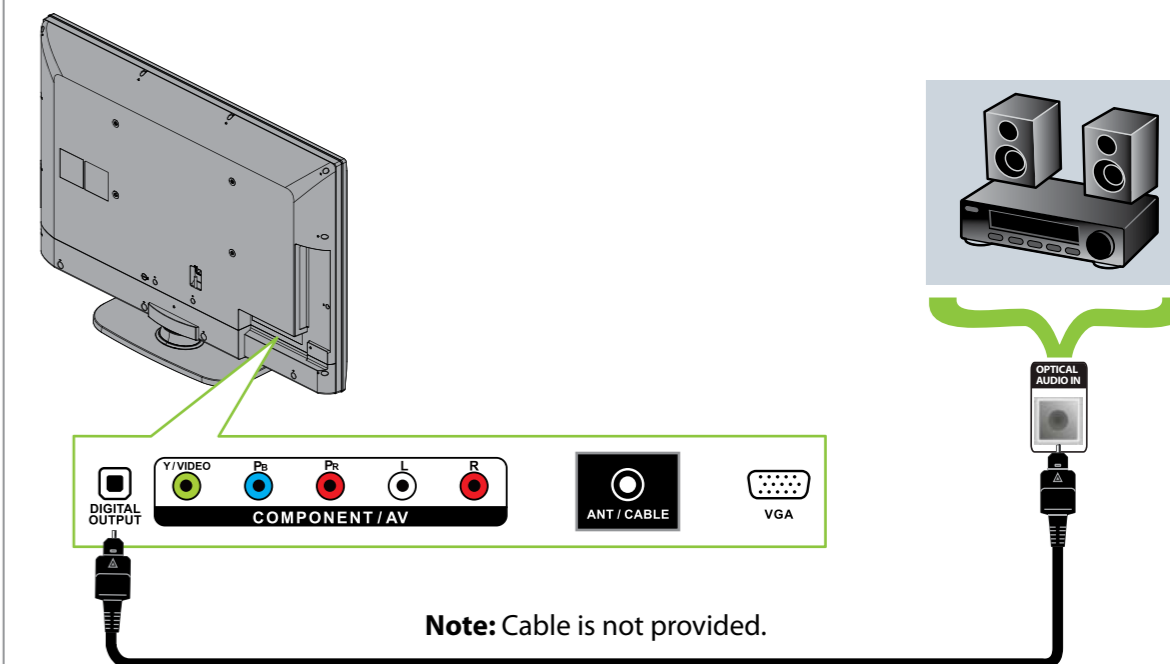

Note: Cable is not provided.

Using analog audio

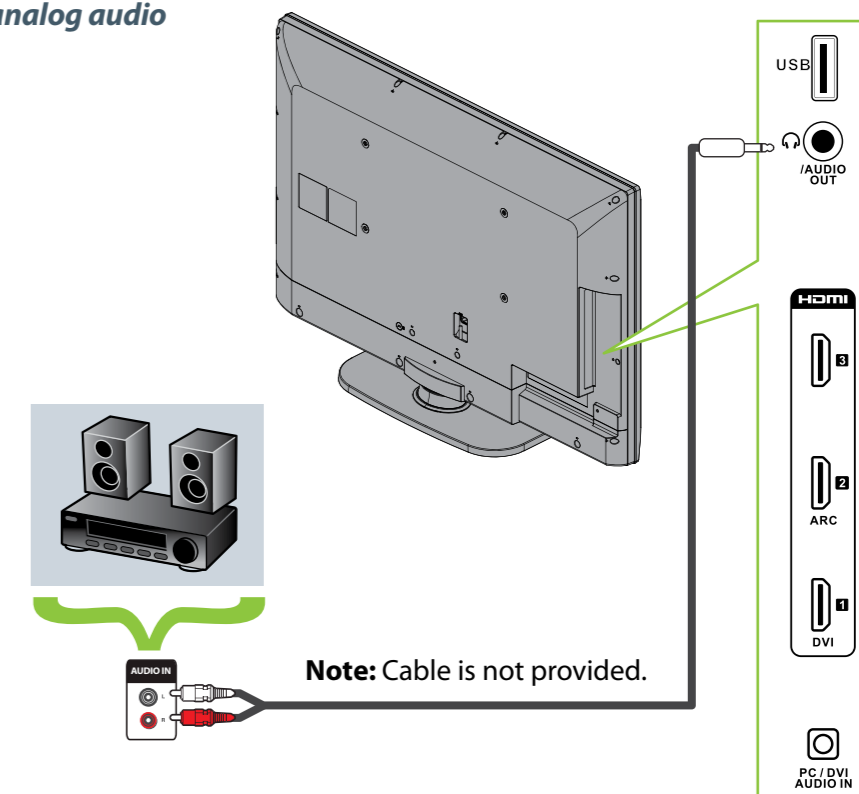

Note: Cable is not provided.

Connecting an antenna/cable wall jack

Connect a coaxial cable (not included) to the **ANT/CABLE IN** jack on the back of your TV and to the Antenna/Cable wall jack.

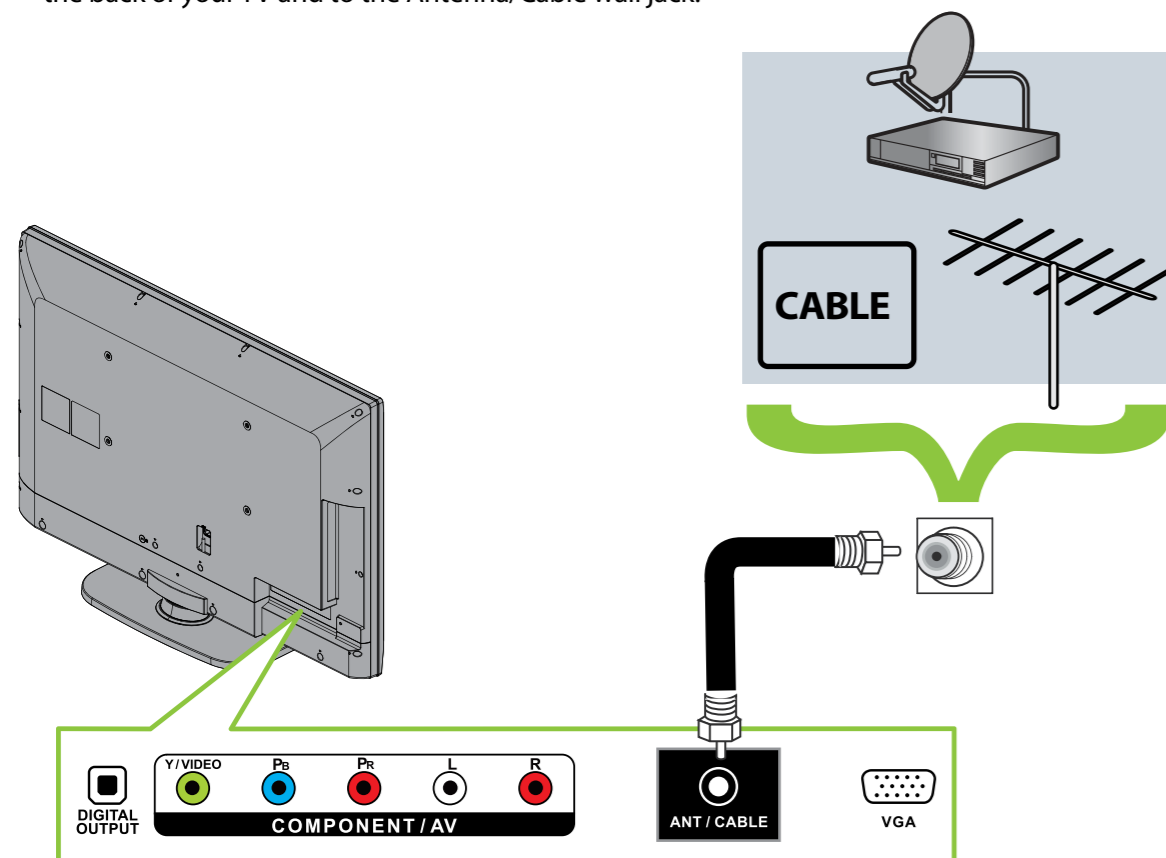

Note: Cable is not provided.

Connecting a home theater system with multiple devices

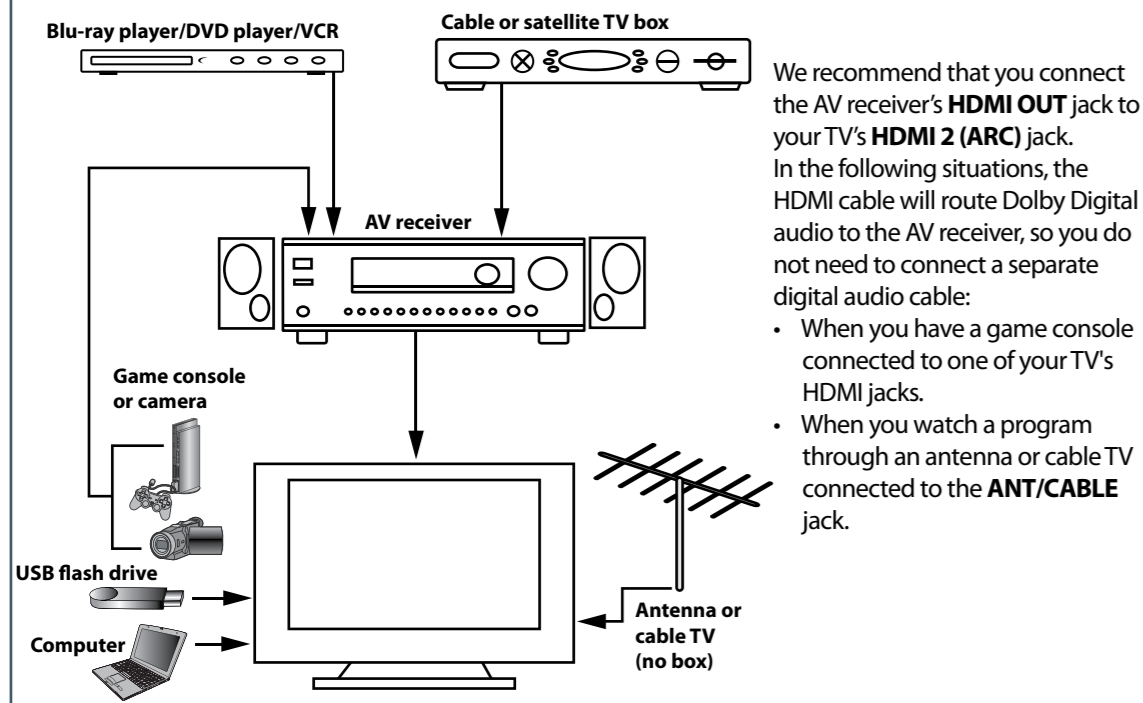

We recommend that you connect the AV receiver's **HDMI OUT** jack to your TV's **HDMI 2 (ARC)** jack. In the following situations, the HDMI cable will route Dolby Digital audio to the AV receiver, so you do not need to connect a separate digital audio cable:

- When you have a game console connected to one of your TV's HDMI jacks.
- When you watch a program through an antenna or cable TV connected to the **ANT/CABLE** jack.

Connecting power

Plug the AC power cord into the **AC IN** jack on the back of your TV, then plug the other end of the cord into a power outlet.

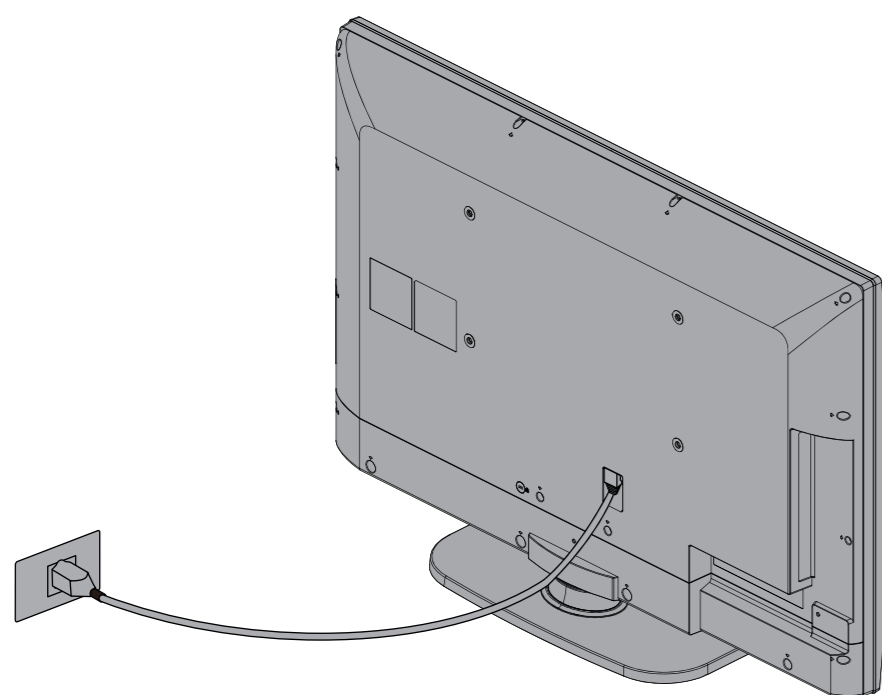

Setting up and using your remote control

- Press the release button on the back of the remote control to remove the battery compartment cover.
- Insert two AAA batteries into the battery compartment. Make sure that the + and - symbols on the batteries match the + and - symbols in the battery compartment.
- Replace the cover.

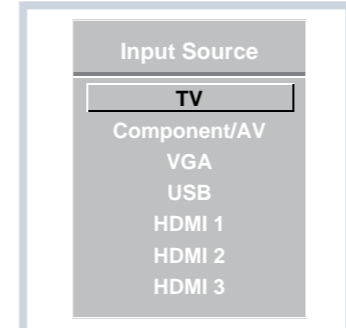
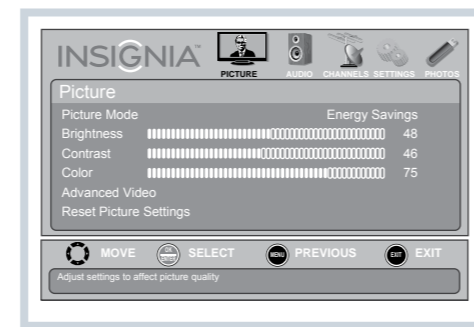
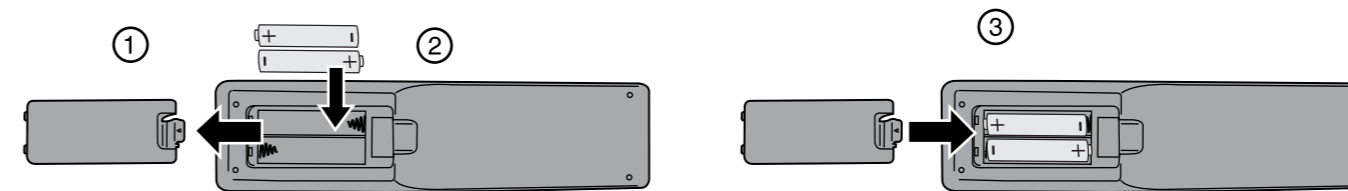

Aspect ratio options

- Normal:** Displays the original 4:3 aspect ratio with vertical black bars on the left and right side of the screen.
- Zoom:** Expands the image to fill the screen. The top and bottom of the image may be cropped.
- Wide:** Use this option to view content recorded in a 16:9 (wide-screen) aspect ratio.
- Cinema:** Stretches the image at the edges, but keeps a clear image in the center.
- Auto:** Automatically adjusts the image based on the screen size and the TV program. **Note:** Auto is only available when **Auto Zoom** in the **CHANNELS** menu is set to **On**.

- Power:** Turns your TV on or off.
- Quick Launch Inputs:** Selects another source connected to your TV.
- Numbers:** Enter channel numbers.
- ENTER:** Confirms selections or changes.
- MENU:** Opens the on-screen menu.
- EXIT:** Closes the on-screen menu.
- INPUT:** Opens the Input Source list.
- CH-LIST:** Opens the channel list.
- Volume:** Changes the volume.
- SLEEP:** Sets the sleep timer.
- ZOOM:** Changes how the picture displays on the screen.
- RECALL:** Returns to the previous channel.
- Arrows:** Navigates in on-screen menus.
- HOME:** Opens the on-screen menu.
- INFO*:** Opens a TV status banner.
- CCD:** Turns closed captioning on or off.
- FAVORITE:** Opens the Favorite Channel List.
- MUTE:** Mutes the sound.
- Channel:** Changes the TV channels.
- PICTURE:** Selects the video mode.
- MTS/SAP:** Cycles through mono, stereo, and secondary audio for analog programs.
- AUDIO:** Selects the audio mode.
- INlink Controls:** Controls HDMI-CEC devices connected to your TV.

Programming your remote control

To program your universal remote control to work with your new Insignia TV, see the table for common codes. If you have problems programming your remote or need a different remote control code, visit www.insigniaproducts.com for the latest remote control code information.

Universal remote controls		Universal remote TV codes										
One for All	Philips	RCA	Sony	Cablevision	Charter	Comcast	Cox	Direct TV	Dish Network	Time Warner	Tivo	Verizon
0054	0198, 0490	135	068, 069, 078, 096, 100, 164, 168, 229, 026	068, 069, 078, 096, 100, 164, 168, 229, 026	2002, 1204, 1423, 1517, 0171, 1963, 0463, 1463, 0842, 1326, 167, 415, 424, 450, 456, 461, 507, 523, 567, 577, 586	10171, 11204, 11326, 11463, 11517, 11641, 11780, 11785, 11892, 11963, 12002	1326, 1463	10171, 11204, 11326, 11517, 11564, 11641, 11963, 12002	720	400, 450, 461, 456, 10463, 1463, 0463	0091	0198, 0490

Turning on your TV for the first time

- Connect your TV's power cord to your TV and a power outlet, then press **Power**. The *Choose Your Menu Language* screen opens.
- Press **▲** or **▼** to highlight a language, then press **ENTER**. The *Choose Your Time Setting* screen opens with **Mode** highlighted.
- Press **◀** or **▶** to select **Auto** or **Manual**, then press **ENTER**. If you select **Auto**, the date and time are set automatically from a digital TV signal. If you select **Manual**, you can manually set the date and time. Press **ENTER**.
- Press **▲** or **▼** to highlight **Home Mode** or **Retail Mode**, then press **ENTER**. If you select **Retail Mode**, a message asks you to confirm your selection. Select **Yes** or **No**. Retail Mode is not an energy-saving mode.
- Press **▲** or **▼** to highlight **Antenna**, **Cable**, or **Satellite Box**, then press **ENTER**.
 - If you select **Antenna**, your TV scans for available channels. The scan may take several minutes.
 - If you select **Cable**, a message asks if you have a cable box.
 - Select **No** if no cable box is connected. Your TV scans for available channels. The scan may take several minutes.
 - Select **Yes** if a cable box is connected. A message asks how you connected the cable box to your TV:
 - Select **AV, Component**, or **HDMI** if you connected a cable box to your TV using one of these cables. Read the message, then press **ENTER** to close the wizard.
 - Select **Coaxial** if you connected a cable box to your TV using a coaxial cable. Read the message, then press **ENTER** to start the channel scan (VHF channels only).
 - If you select **Satellite Box**, a message asks how you connected the satellite box to your TV:
 - Select **AV, Component**, or **HDMI** if you connected a satellite box to your TV using one of these cables. Read the message, then press **ENTER** to close the wizard.
 - Select **Coaxial** if you connected a satellite box to your TV using a coaxial cable. Read the message, then press **ENTER** to start the channel scan (VHF channels only).



One-year limited warranty
Visit www.insigniaproducts.com for details.

Need additional help?
See your **Online User Guide!** This comprehensive guide includes everything from basic how-to steps to more advanced features. A copy of your *User Guide* is not provided in the box but is available online. Go to www.insigniaproducts.com, click **Support & Service**, enter your model number in the **Product Search** field, then click **Search**.
Check out our online **community forum** at www.insigniaproducts.com for helpful information from other Insignia TV owners.

We're here for you
www.insigniaproducts.com
For customer service, call:
877-467-4289 (U.S./Canada markets)

Distributed by Best Buy Purchasing, LLC
7601 Penn Avenue South, Richfield, MN USA 55423-3645
© 2012 BBY Solutions, Inc.
All rights reserved. INSIGNIA is a trademark of BBY Solutions, Inc. Registered in some countries. All other products and brand names are trademarks of their respective owners.

WE ARE GOING GREEN!
A copy of your *User Guide* is not provided in the box but is available online. Go to www.insigniaproducts.com, click **Support & Service**, enter your model number in the **Product Search** field, then click **Search**.

Free Manuals Download Website

<http://myh66.com>

<http://usermanuals.us>

<http://www.somanuals.com>

<http://www.4manuals.cc>

<http://www.manual-lib.com>

<http://www.404manual.com>

<http://www.luxmanual.com>

<http://aubethermostatmanual.com>

Golf course search by state

<http://golfingnear.com>

Email search by domain

<http://emailbydomain.com>

Auto manuals search

<http://auto.somanuals.com>

TV manuals search

<http://tv.somanuals.com>