

User Guide
Digital Clock Radio with FM

NS-CLOPP1

INSIGNIA™

Before using your new product, please read these instructions to prevent any damage.

Insignia NS-CLOPP1 Digital Clock Radio with FM

Contents

Introduction	2
Important safety instructions	3
Features	4
Top buttons	4
Back	5
LCD	6
Package contents	7
Setting up your radio	7
Installing backup batteries	7
Connecting the AC/DC power adapter	8
Using your radio	8
Setting the time	8
Setting the alarm sound	9
Setting the alarm time	9
Using the snooze feature	10
Turning off the alarm	10
Setting the sleep timer	10
Adjusting the LCD brightness	11
Playing your radio	11
Programming a radio station preset	12
Tuning to a preset radio station	12
Connecting an audio device	12
Specifications	13
Legal notices	13
90-day limited warranty - Insignia	14

Introduction

Congratulations on your purchase of a high-quality Insignia product. Your NS-CLOPP1 represents the state of the art in digital clock radio design and is designed for reliable and trouble-free performance.

Important safety instructions

- 1 Read these instructions.
- 2 Keep these instructions.
- 3 Heed all warnings.
- 4 Follow all instructions.
- 5 Do not use this apparatus near water.
- 6 Clean only with dry cloth.
- 7 Do not block any ventilation openings. Install in accordance with the manufacturer's instructions.
- 8 Do not install near any heat sources such as radiators, heat registers, stoves, or other apparatus (including amplifiers) that produce heat.
- 9 Do not defeat the safety purpose of the polarized or grounding-type plug. A polarized plug has two blades with one wider than the other. A grounding type plug has two blades and a third grounding prong. The wide blade or the third prong are provided for your safety. If the provided plug does not fit into your outlet, consult an electrician for replacement of the obsolete outlet.
- 10 Protect the power cord from being walked on or pinched particularly at plugs, convenience receptacles, and the point where they exit from the apparatus.
- 11 Only use attachments/accessories specified by the manufacturer.
- 12 Unplug this apparatus during lightning storms or when unused for long periods of time.
- 13 Refer all servicing to qualified service personnel. Servicing is required when the apparatus has been damaged in any way, such as power-supply cord or plug is damaged, liquid has been spilled or objects have fallen into the apparatus, the apparatus has been exposed to rain or moisture, does not operate normally, or has been dropped.
- 14 To reduce the risk of fire or electric shock, do not expose this device to rain, moisture, dripping, or splashing, and no objects filled with liquids, such as vases, shall be placed on it.
- 15 The wall plug is the disconnecting device. The plug must remain readily operable.
- 16 Batteries should not be exposed to excessive heat such as sunshine, fire, or the like.







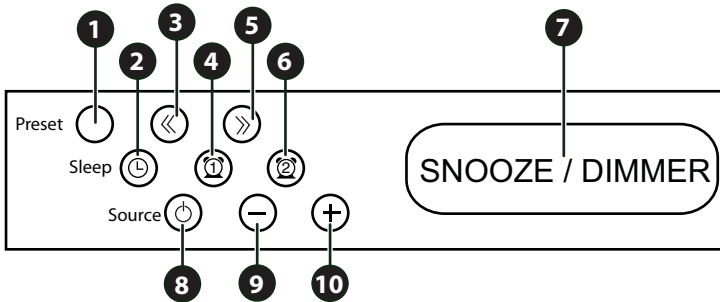

Caution

Danger of explosion if battery is incorrectly replaced. Replace only with the same or equivalent type.

Features

Top buttons



#	Item	Description
1	Preset  button	Press to program a radio station preset or to tune to a preset radio station. See "Programming a radio station preset" on page 12 or "Tuning to a preset radio station" on page 12.
2	Sleep  button	Press to set the time or the sleep timer. For more information, see "Setting the time" on page 8 or "Setting the sleep timer" on page 10.
3	 (previous/fast reverse) button	Press and hold for one second to go to the next lower radio station. Quickly press and release to manually tune to a lower radio frequency.
4	 (Alarm 1) button	Press to set Alarm 1. See "Setting the alarm sound" on page 9 and "Setting the alarm time" on page 9.
5	 (next/fast forward) button	Press and hold for one second to go to the next higher radio station. Quickly press and release to manually tune to a higher radio frequency.
6	 (Alarm 2) button	Press to set Alarm 2. See "Setting the alarm sound" on page 9 and "Setting the alarm time" on page 9.
7	 button	When the alarm turns on, press to turn off the alarm for 10 minutes. See "Using the snooze feature" on page 10. Press to adjust the LCD brightness. See "Adjusting the LCD brightness" on page 11.
8	Source  (source/standby) button	When your radio is turned off (in standby mode), press to turn it on. See "Playing your radio" on page 11. When your radio is turned on, press and hold for more than two seconds to turn your radio off (put in standby mode). When your radio is turned on, quickly press and release to switch between playing the radio and playing a connected audio device. See "Connecting an audio device" on page 12.

#	Item	Description
9	⊖ (volume down) button	Press to decrease the volume.
10	⊕ (volume up) button	Press to increase the volume.

Back

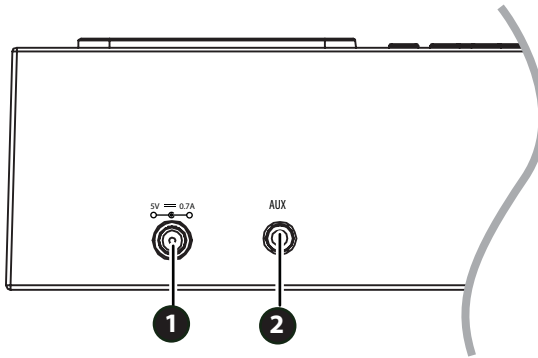

#	Item	Description
1	DC IN jack	Connect the AC/DC power adapter to this the jack. See “Connecting the AC/DC power adapter” on page 8.
2	AUX jack	Connect an audio device to this jack to play the audio from the device through the radio speakers. See “Connecting an audio device” on page 12.

LCD

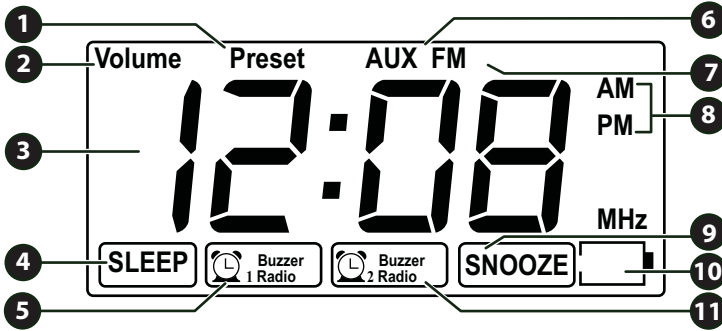

#	Icon	Description
1	Preset	When you are programming a radio station preset, "Preset" and the preset number (P-01 through P-10) appear in the center of the LCD. See "Programming a radio station preset" on page 12. When you are tuning to a radio station preset, "Preset" and the preset number (P-01 through P-10) appear in the center of the LCD. See "Tuning to a preset radio station" on page 12.
2	Volume	After you select the alarm sound, this icon indicates that you can change the volume of the alarm. See "Setting the alarm sound" on page 9. When you are playing the radio, the "Volume" icon lights and the current volume level (1 through 15) appears in the center of the LCD.
3	Current time	Displays the current time.
4	Sleep	Lights when the sleep timer is active. See "Setting the sleep timer" on page 10.
5	Alarm 1	Lights when Alarm 1 has been set. See "Setting the alarm time" on page 9.
6	AUX	Lights when a connected audio device is selected as the audio source. See "Connecting an audio device" on page 12.
7	FM	Lights when the radio is selected as the audio source.
8	AM/PM	"AM" lights after midnight and before noon. "PM" lights after noon and before midnight.
9	Snooze	Lights when your radio is in snooze mode. See "Using the snooze feature" on page 10.
10	Battery	Lights when no backup batteries are installed or when the backup battery charge is low.
11	Alarm 2	Lights when Alarm 2 has been set. See "Setting the alarm time" on page 9.

Package contents

- Digital clock radio with FM
- AC/DC power adapter
- *Quick Setup Guide*
- *User Guide*

Setting up your radio

Installing backup batteries

The backup batteries provide power to backup the time setting when you unplug the AC/DC power adapter.

Cautions

- Use only the size and type of batteries specified.
- Do not mix old and new batteries.
- Make sure that you follow the correct polarity as indicated in the battery compartment.
- Do not try to recharge batteries not intended to be recharged. They can overheat and rupture. (Follow the battery manufacturer's directions.)
- Do not throw batteries into a fire. Dispose of used batteries as hazardous waste.

Note

If you unplug the AC/DC power adapter and the backup batteries are dead or not installed, the time setting is lost.

To install batteries:

- 1 Push the latch to release the battery compartment cover on the bottom of your radio, then lift the cover off the battery compartment.

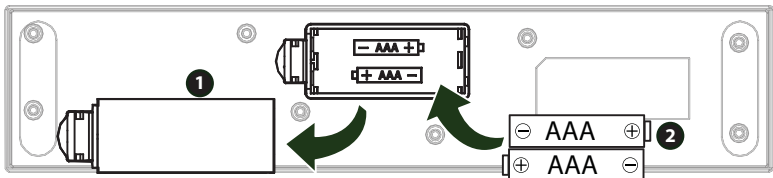

- 2 Insert two AAA batteries (not included) into the battery compartment. Make sure that the + and - symbols on the batteries align with the + and - symbols inside the compartment.

- 3 Insert the tab on the battery compartment cover into the slot on the battery compartment, then press the cover down until it clicks into place.

Connecting the AC/DC power adapter

Note

If you unplug the AC/DC power adapter and the backup batteries are dead or not installed, the time setting is lost.

To connect the AC/DC power adapter:

- 1 Plug the small connector on the power adapter into the **DC IN** jack on the back of your radio.
- 2 Plug the other connector on the power adapter into a power outlet.











Using your radio

Setting the time

Notes

"AM" or "PM" appears on the LCD to the right of the time. When you set the time, make sure that the "AM" or "PM" displays correctly.

To set the time:

- 1 Press **Sleep**  for about two seconds until the hour digits blink on the LCD.
- 2 Press  or  to increase the hour or press  or  to decrease the hour.
- 3 Press **Sleep**  again. The minutes digits blink on the LCD.
- 4 Press  or  to increase the minutes or press  or  to decrease the minutes.
- 5 Press **Sleep**  again or wait 10 seconds to save the time setting and exit time setting mode.









Setting the alarm sound

Your radio has two alarms and can play the buzzer or the radio for the alarm sound. You can use the same alarm sound for both alarms or set one alarm to use the buzzer and the other alarm to use the radio.





Note





Button presses must be within three seconds of each other. If you do not press a button within three seconds, your radio exits alarm setting mode.

To set the alarm sound:

- 1 Press  (Alarm 1) or  (Alarm 2). The  or  icon blinks on the LCD.
- 2 To use the radio as the alarm sound, press  (Alarm 1) or  (Alarm 2) once. The  or  icon blinks on the LCD and the alarm sound is set to the radio. Wait three seconds to save the setting and exit alarm sound setting mode. When the alarm turns on, the last tuned radio station plays.

OR

To use the buzzer as the alarm sound, press  (Alarm 1) or  (Alarm 2) twice. The  or  icon blinks on the LCD and the alarm sound is set to the buzzer. Wait three seconds to save the setting and exit alarm sound setting mode.

- 3 To completely turn off the alarm, press  (Alarm 1) or  (Alarm 2) repeatedly until the  or  icon disappears from the LCD.









Setting the alarm time

Your radio has two alarms that you can set for different times.

Notes

- "AM" or "PM" appears on the LCD to the right of the time. When you set the time, make sure that the "AM" or "PM" displays correctly.
- Button presses must be within 10 seconds of each other. If you do not press a button within 10 seconds, your radio exits alarm setting mode.

To set the alarm time:

- 1 Press and hold  (Alarm 1) or  (Alarm 2) for about two seconds until the hour digits blink on the LCD.
- 2 Press  or  to increase the hour or press  or  to decrease the hour.
- 3 Press  (Alarm 1) or  (Alarm 2) again. The minutes digits blink on the LCD.

- 4 Press **+** or **▶▶** to increase the minutes or press **-** or **◀◀** to decrease the minutes.
- 5 Press **Ⓜ** (Alarm 1) or **Ⓜ** (Alarm 2) again. The **Volume** icon appears on the LCD and the volume digits blink.
- 6 Press **+** or **▶▶** to increase the alarm volume or press **-** or **◀◀** to decrease the alarm volume. The alarm volume range is from 1 to 15 with 15 being the loudest setting. The default setting is 10.
- 7 Press **Ⓜ** (Alarm 1) or **Ⓜ** (Alarm 2) again to save the time setting and exit alarm setting mode.

Turning off the alarm

To turn off the alarm:

- Press any button except **SNOOZE / DIMMER**.

Using the snooze feature

Note

You can press **SNOOZE / DIMMER** a total of six times. If you press it a seventh time, the alarm turns off.

To use the snooze feature:

- When the alarm sounds, press **SNOOZE / DIMMER**. The alarm turns off for 10 minutes and **SNOOZE** appears on the LCD.

Setting the sleep timer

You can specify the amount of time your radio waits before it turns off automatically.

To set the sleep timer:

- Press **Sleep** **Ⓜ** repeatedly to select the amount of time you want your radio to wait before it turns off automatically. You can select **15**, **30**, **45**, **60**, or **90** minutes. The time you select and the **SLEEP** icon appear on the LCD.
- To turn off the sleep timer, press **Sleep** **Ⓜ** repeatedly until **00** appears and the **SLEEP** icon disappears.

Adjusting the LCD brightness

When you adjust the LCD brightness, your radio retains the setting and uses this setting the next time you turn on your radio.

To adjust the LCD brightness:









- 1 Quickly press  repeatedly to select a brightness level. You can select **High**, **Middle**, or **Low**.
- 2 Wait a few seconds to save your setting and exit brightness mode.

Playing your radio

Notes

When you turn off your radio, it goes into standby mode.





To play your radio:

- 1 Make sure that you have connected the AC/DC power adapter. See “Connecting the AC/DC power adapter” on page 8.
- 2 Press **Source** . Your radio turns on.
- 3 Press  or  to manually select a radio frequency.
OR
Press and hold  or  to automatically tune to the next lower or higher radio station.
- 4 Press  or  to increase or decrease the volume.
- 5 To turn off your radio, press and hold **Source**  for two seconds. **OFF** appears on the LCD for three seconds, then your radio turns off.

Programming a radio station preset

A radio station preset lets you assign a preset number to a radio station to make it easier to tune to a station. You can program 10 presets.

To program a radio station preset:

- 1 Tune to the radio station you want to program, then press and hold **Preset**  for two seconds. The "Preset" icon lights and the next available preset number (P-01 through P-10) appears in the center of the LCD.
- 2 If you want to use a different preset number, press  or  repeatedly until the number you want appears on the LCD.
- 3 Within 10 seconds, press **Preset**  again to save your station preset. If you do not press **Preset**  within 10 seconds, your radio exits preset mode and your station preset is not saved.

Tuning to a preset radio station

After you program radio station presets, you can quickly tune to a preset station.





To tune to a preset radio station:

- Quickly press and release **Preset**  one or more times until the preset number for the station you want appear in the center of the LCD. Your radio tunes to the station.

Connecting an audio device

You can connect an audio device, such as an MP3 player, to your radio to play music through your radio's speakers.

To connect an audio device:

- 1 Plug an audio cable with a 3.5 mm connector (not included) into the **AUX IN** jack on the back of your radio and into the audio out jack on your audio device.
- 2 Press **Source**  to turn on your radio, then press **Source**  repeatedly until **AUX** appears on the LCD.
- 3 Press  or  to increase or decrease the device volume.
- 4 Use the controls on the audio device to control playback.

Specifications

Total RMS power	2 W @1kHz, @ 10% THD
Total peak power	4 W
Signal-to-noise ratio	≥ 65dB
Frequency response	300Hz - 20kHz
Speakers	2 × 40 mm
Batteries	2 AAA
Dimensions (W × D × H)	9.8 × 2.1 × 2.1 in. (250 × 54 × 54 mm)
Weight	1.1 lbs. (0.5 kg)

Legal notices

FCC Statement

This device complies with Part 15 of the FCC Rules. Operation is subject to the following two conditions: (1) this device may not cause harmful interference, and (2) this device must accept any interference received, including interference that may cause undesired operation.

This equipment has been tested and found to comply with the limits for a Class B digital device, pursuant to Part 15 of the FCC Rules. These limits are designed to provide reasonable protection against harmful interference in a residential installation. This equipment generates, uses and can radiate radio frequency energy and, if not installed and used in accordance with the instructions, may cause harmful interference to radio communications. However, there is no guarantee that interference will not occur in a particular installation. If this equipment does cause harmful interference to radio or television reception, which can be determined by turning the equipment off and on, the user is encouraged to try to correct the interference by one or more of the following measure:

- Reorient or relocate the receiving antenna
- Increase the separation between the equipment and receiver.
- Connect the equipment into an outlet on a circuit different from that to which the receiver is connected.
- Consult the dealer or an experienced radio/TV technician for help

Warning: Changes or modifications not expressly approved by the party responsible for compliance could void the user's authority to operate the equipment.

IC Statement

This device complies with Industry Canada licence-exempt RSS standard(s).

Operation is subject to the following two conditions: (1) this device may not cause interference, and (2) this device must accept any interference that may cause undesired operation of the device.

This equipment complies with IC radiation exposure limits set forth for an uncontrolled environment.

Canada ICES-003 statement

This Class B digital apparatus complies with Canadian ICES-003.

90-day limited warranty - Insignia

Definitions:

Insignia Products ("Insignia") warrants to you, the original purchaser of this new Insignia-branded product ("Product"), that the Product shall be free of defects in the original manufacturer of the material or workmanship for a period of ninety (90) days from the date of your purchase of the Product ("Warranty Period"). For this warranty to apply, your Product must be purchased in the United States or Canada from a Best Buy or Future Shop authorized dealer of Insignia brand products only that are packaged with this warranty statement.

How long does the coverage last?

The Warranty Period lasts for ninety (90) days from the date you purchased the Product. Your purchase date is printed on the receipt you received with the Product.

What does this warranty cover?

During the Warranty Period, if the original manufacture of the material or workmanship of the Product is determined to be defective by an authorized Insignia repair center or store personnel, Insignia will (at its sole option): (1) repair the Product with new or rebuilt parts; or (2) replace the Product at no charge with new or rebuilt comparable products or parts. Products and parts replaced under this warranty become the property of Insignia and are not returned to you. If service of Products or parts are required after the Warranty Period expires, you must pay all labor and parts charges. This warranty lasts as long as you own your Insignia Product during the Warranty Period. Warranty coverage terminates if you sell or otherwise transfer the Product.

How to obtain warranty service?

If you purchased the Product at a Best Buy or Future Shop retail store location, please take your original receipt and the Product to any Best Buy or Future Shop store. Make sure that you place the Product in its original packaging or packaging that provides the same amount of protection as the original packaging. If you purchased the Product from a Best Buy or Future Shop online web site, mail your original receipt and the Product to the address listed on the web site. Make sure that you put the Product in its original packaging or packaging that provides the same amount of protection as the original packaging.

To obtain warranty service, in the United States call 1-888-BESTBUY, Canada call 1-866-BESTBUY for Future Shop call 1-800-663-2275. Call agents may diagnose and correct the issue over the phone.

Where is the warranty valid?

This warranty is valid only in the United States and Canada at Best Buy or Future Shop branded retail stores or websites to the original purchaser of the product in the county where the original purchase was made.

What does the warranty not cover?

This warranty does not cover:

- Customer instruction/education
- Installation
- Set up adjustments
- Cosmetic damage
- Damage due to acts of God, such as power surges
- Accident(s)
- Misuse

- Abuse
- Negligence
- Commercial purposes/use, including but not limited to use in a place of business or in communal areas of a multiple dwelling condominium or apartment complex, or otherwise used in a place of other than a private home.
- Modification of any part of the Product, including the antenna
- Display panel damaged by static (non-moving) images applied for lengthy periods (burn-in).
- Damage due to incorrect operation or maintenance
- Connection to an incorrect voltage or power supply
- Attempted repair by any person not authorized by Insignia to service the Product
- Products sold "as is" or "with all faults"
- Consumables, including but not limited to batteries (i.e. AA, AAA, C etc.)
- Products where the factory applied serial number has been altered or removed
- Loss or Theft of this product or any part of the product
- Up to three (3) pixel failures (dots that are dark or incorrectly illuminated) grouped in an area smaller than one tenth (1/10) of the display size or up to five (5) pixel failures throughout the display. (Pixel based displays may contain a limited number of pixels that may not function normally.)
- Failures or Damage caused by any contact including but not limited to liquids, gels or pastes.

REPAIR REPLACEMENT AS PROVIDED UNDER THIS WARRANTY IS YOUR EXCLUSIVE REMEDY FOR BREACH OF WARRANTY. INSIGNIA SHALL NOT BE LIABLE FOR ANY INCIDENTAL OR CONSEQUENTIAL DAMAGES FOR THE BREACH OF ANY EXPRESS OR IMPLIED WARRANTY ON THIS PRODUCT, INCLUDING, BUT NOT LIMITED TO, LOST DATA, LOSS OF USE OF YOUR PRODUCT, LOST BUSINESS OR LOST PROFITS. INSIGNIA PRODUCTS MAKES NO OTHER EXPRESS WARRANTIES WITH RESPECT TO THE PRODUCT, ALL EXPRESS AND IMPLIED WARRANTIES FOR THE PRODUCT, INCLUDING, BUT NOT LIMITED TO, ANY IMPLIED WARRANTIES OF AND CONDITIONS OF MERCHANTABILITY AND FITNESS FOR A PARTICULAR PURPOSE, ARE LIMITED IN DURATION TO THE WARRANTY PERIOD SET FORTH ABOVE AND NO WARRANTIES, WHETHER EXPRESS OR IMPLIED, WILL APPLY AFTER THE WARRANTY PERIOD. SOME STATES, PROVINCES AND JURISDICTIONS DO NOT ALLOW LIMITATIONS ON HOW LONG AN IMPLIED WARRANTY LASTS, SO THE ABOVE LIMITATION MAY NOT APPLY TO YOU. THIS WARRANTY GIVES YOU SPECIFIC LEGAL RIGHTS, AND YOU MAY ALSO HAVE OTHER RIGHTS, WHICH VARY FROM STATE TO STATE OR PROVINCE TO PROVINCE.

Contact Insignia:

For customer service please call 1-877-467-4289

www.insigniaproducts.com

Distributed by Best Buy Purchasing, LLC

7601 Penn Avenue South, Richfield, Minnesota, U.S.A. 55423-3645

© 2013 BBY Solutions, Inc.

All rights reserved. INSIGNIA is a trademark of BBY Solutions, Inc. Registered in some countries. All other products and brand names are trademarks of their respective owners.

INSIGNIA

INSIGNIA is a registered trademark of BBY Solutions, Inc.

Registered in some countries.

Distributed by Best Buy Purchasing, LLC, 7601 Penn Ave South, Richfield, MN 55423 U.S.A.

©2013 BBY Solutions, Inc.

All Rights Reserved

1-877-467-4289

www.insigniaproducts.com

V3 ENGLISH
13-0144

Free Manuals Download Website

<http://myh66.com>

<http://usermanuals.us>

<http://www.somanuals.com>

<http://www.4manuals.cc>

<http://www.manual-lib.com>

<http://www.404manual.com>

<http://www.luxmanual.com>

<http://aubethermostatmanual.com>

Golf course search by state

<http://golfingnear.com>

Email search by domain

<http://emailbydomain.com>

Auto manuals search

<http://auto.somanuals.com>

TV manuals search

<http://tv.somanuals.com>