

User Guide

Digital AM/FM Clock Radio

NS-CLOPP2

INSIGNIA™

Insignia NS-CLOPP2

Digital AM/FM Clock Radio

Contents

Introduction	2
Important Safety Instructions	3
Features	5
Set up your clock radio	8
Use your clock radio	12
Clean your clock radio	16
Troubleshooting	16
Specifications	17
Legal notices	17
One-year limited warranty - Insignia	21

Introduction

Congratulations on your purchase of this high-quality Insignia Digital AM/FM Clock Radio. This system represents the state of the art in clock radio design and is designed for reliable and trouble-free performance.

This *User Guide* explains how to correctly set up, operate, and get the best performance from your Insignia clock radio. Read this guide carefully before setting up your clock radio, then keep it handy for quick reference.

Important Safety Instructions

- 1 Read these instructions.
- 2 Keep these instructions.
- 3 Heed all warnings.
- 4 Follow all instructions.
- 5 Do not use this apparatus near water.
- 6 Clean only with dry cloth.
- 7 Do not block any ventilation openings. Install in accordance with the manufacturer's instructions.
- 8 Do not install near any heat sources such as radiators, heat registers, stoves, or other apparatus (including amplifiers) that product heat.
- 9 Do not defeat the safety purpose of the polarized or grounding plug. A polarized plug has two blades with one wider than the other. A grounding plug has two blades and a third grounding prong. The wide blade or the third prong is provided for your safety. If the provided plug does not fit into your outlet, consult an electrician for replacement of the obsolete outlet.
- 10 Protect the power cord from being walked on or pinched particularly at the plugs, convenience receptacles, and at the point where they exit from the apparatus.
- 11 Only use attachments/accessories provided by the manufacturer.
- 12 Use only with the cart, stand, tripod, bracket, or table specified by the manufacturer, or sold with the apparatus. When a cart or rack is used, use caution when moving the cart/apparatus combination to avoid injury from tip-over.
- 13 Unplug the apparatus during lightning storms or when unused for long periods of time.



14. Refer all servicing to qualified personnel. Servicing is required when the apparatus has been damaged in any way, such as power supply cord or plug is damaged, liquid has been spilled or objects have fallen into the apparatus, has been exposed to rain or moisture, does not operate normally, or has been dropped.
- 15 Please keep the unit in a good ventilation environment. Do not install this equipment in a confined space such as a bookcase or similar unit.
- 16 **WARNING:** To reduce the risk of fire or electric shock, do not expose apparatus to rain or moisture. The apparatus shall not be exposed to dripping or apparatus.
- 17 **WARNING:** The main plug is used as a disconnect device. The disconnect device shall remain readily operable.
- 18 **WARNING:** The batteries (battery pack or batteries installed) shall not be exposed to excessive heat, such as sunshine, fire, or the like.
- 19



The lightning flash with arrowhead symbol within an equilateral triangle is intended to alert the user to the presence of non-insulated “dangerous voltage” within the product’s enclosure that may be of sufficient magnitude to constitute a risk of electrical shock.

WARNING: To reduce the risk of electric shock, do not remove cover (or back) as The exclamation point within an equilateral triangle is intended to alert the user to the presence of important operating and maintenance instructions in the literature accompanying the appliance.

- 20 The apparatus is classified as a class II apparatus.

Features

Package contents

Your clock radio includes the following items:

- Clock radio
- AC adapter
- Batteries "AA" (2)
- *User Guide*

LED display

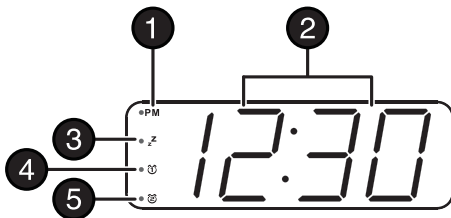





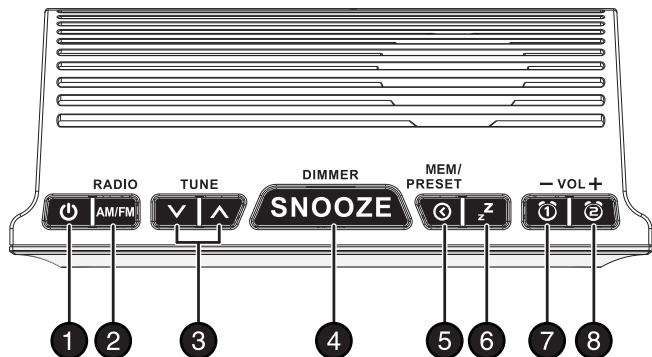

#	Item	Description
1	PM indicator	When lit, indicates that the time shown is after noon (PM).
2	TIME/ALARM/ FREQUENCY display	In standby mode, digits show current time or alarm time hours and minutes. In radio mode, digits show the current radio frequency.
3	Z Sleep timer indicator	When lit, indicates that the sleep timer is set.
4	🔔 Alarm 1 indicator	When lit, indicates that Alarm 1 is set.

#	Item	Description
5	 Alarm 2 indicator	When lit, indicates that Alarm 2 is set.

Top panel



#	Item	Description
1	 (power) button	Press to turn the radio on. Press again to turn the radio to standby mode.
2	AM/FM (RADIO) button	Press to toggle between AM and FM channels.
3	TUNE 	In radio mode, press to tune the radio to the previous or next station. When setting the clock, press to set the hours and minutes backward or forward. When setting the alarm, use to select the alarm time or to select the alarm mode or adjust the alarm volume.

#	Item	Description
4	SNOOZE (DIMMER) button	When the alarm sounds, press to mute the alarm for nine minutes. Press to adjust the display brightness.
5	 /MEM/ PRESET button	In standby mode, press and hold to set the clock time. When listening to the radio, press and hold to enter preset mode for presetting your desired station or press to select a preset station.
6	 (sleep) button	Press to set the sleep timer. You can select 90 min, 60 min, 45 min, 30 min, 15 min, or OFF . The time appears on the display.
7	VOL - /  button	In AM or FM mode, press to decrease the volume. In alarm mode, press to set alarm 1.
8	VOL + /  button	In AM or FM mode, press to increase the volume. In alarm mode, press to set alarm 2.

Back panel

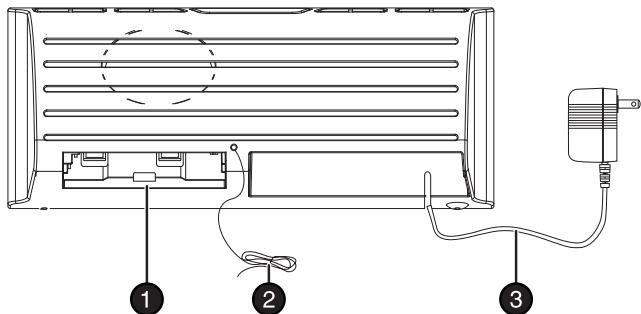

#	Item	Description
1	Battery compartment	Insert two AA batteries into this compartment for battery backup.
2	FM antenna wire	Improves FM radio reception.
3	AC power adapter	Plug the AC power adapter into a wall plug to power your clock radio.

Set up your clock radio

Install the backup batteries

The clock radio uses a backup battery system to provide continuous alarm operation and clock settings in the event of a power failure. If the backup batteries have been installed and a power failure occurs or the AC power adapter is accidentally disconnected, the display will not remain lit, but the current time and alarm time settings will be temporarily maintained. Otherwise, you must reset the time and alarm settings.

Make sure that the AC power adapter is plugged in, otherwise all settings may be lost during battery installation.

- 1 Turn your clock radio around to the back, then open the battery compartment cover located on the right side of your clock radio.

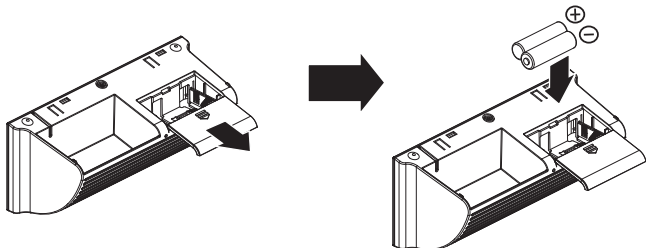

- 2 Insert two "AA" batteries (not included) into the battery compartment. Make sure that the + and - symbols on the batteries align with the + and - symbols inside the battery compartment.
- 3 Close the battery compartment.

Caution

- Do not recharge, short, disassemble, or heat the batteries, or dispose of in a fire.
- Dispose of batteries in the proper manner, according to federal, state, and local regulations.
- Remove the batteries when the charge is depleted or if your clock radio will be left unplugged for an extended period.
- If the batteries leak, clean the battery compartment with a cloth. If chemicals touch your skin, wash immediately. Battery chemicals can cause a rash.
- Do not use a mixture of old and new batteries.
- Do not mix alkaline, standard (carbon-zinc), and rechargeable batteries.
- There is a danger of explosion if the batteries are incorrectly replaced. Replace only with the same or equivalent type.

When to Replace the Batteries

- To check the condition of the batteries, unplug the AC power adapter from the wall outlet and plug it in again after a few minutes. If the displayed time is incorrect, replace the batteries with new ones.

Connect the AC adapter

Make sure that the AC power outlet matches the AC adapter's power specifications (120 V ~ 60 Hz) prior to plugging in the adapter.

- Plug the AC power adapter into an AC power outlet.

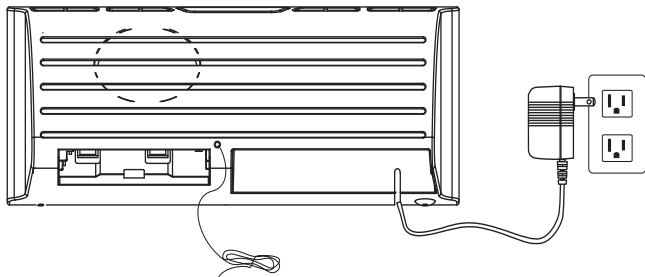

Set the clock

- 1 Plug in the AC power adapter. The hour digits will blink on the display.

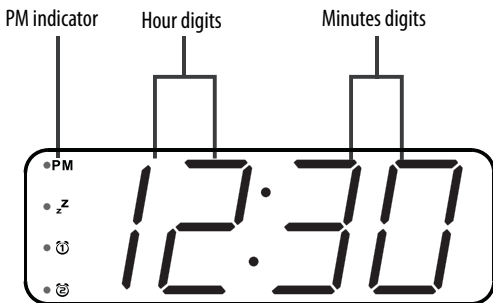

- 2 Press **TUNE** ∇/\wedge repeatedly to set the correct hour, then press **⏻/MEM/PRESET** to confirm the setting. The minutes digits will blink.

- 3 Press **TUNE** ∇/\blacktriangle repeatedly to set the correct minutes, then press \odot /**MEM/PRESET** to confirm the setting.

Note

- When you set the clock to a time after noon, the PM indicator lights.
- 12:00 PM = Noon.
- To reset the clock in standby mode, press and hold \odot /**MEM/PRESET**. The hour digits will blink on the display.

Use your clock radio

Before using your clock radio, make sure the AC power adapter is securely connected.

Turn your clock radio on and off

- 1 Press \odot (power). Your clock radio turns on.
- 2 Press **SNOOZE/DIMMER** to control the brightness of the LED.
- 3 Press \odot (power) again to switch your clock radio to standby mode.

Set and use the alarm

Note

- Your clock radio must be in standby mode (radio off) to set the alarm.
- Your clock radio can be set to activate twice a day by setting different times in ALARM 1 and ALARM 2.

- 1 Press **VOL -/1** or **VOL +/2** (depending upon the alarm you want to set). The 1 or 2 indicator lights up.

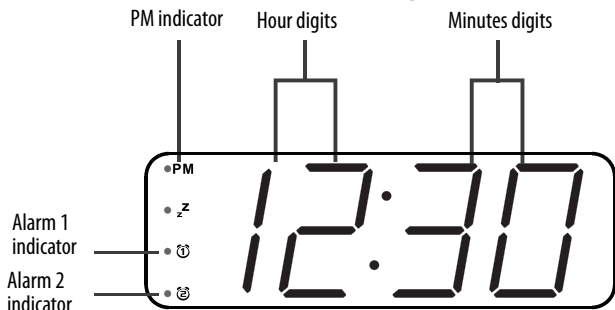

- 2 Press and hold **VOL -/1** (or **VOL +/2**). The hour digits will blink on the display.
- 3 Press **TUNE V/^** repeatedly to set the correct hour, then press **VOL -/1** (or **VOL +/2**) to confirm the setting. The minutes digits will blink.
- 4 Press **TUNE V/^** repeatedly to set the correct minutes, then press **VOL -/1** (or **VOL +/2**) to confirm the setting.
- 5 Press **TUNE V/^** to select the alarm sound source (either buzzer or radio). The alarm mode name will be shown on the display (Buzzer=Bu or Radio=rAd). Press **VOL -/1** (or **VOL +/2**) to confirm. If you select radio, tune to the station you want and set the volume.
- 6 Press **TUNE V/^** to set the volume of the alarm. The alarm will turn on at the time you have set and will turn off automatically after 59 minutes.
- 7 Repeat these steps to set the alarm to a different time.

Note

In standby mode, press and hold **VOL -/1** (or **VOL +/2**) to reset the alarm time.

Mute, turn off, or cancel the alarm

- 1 Press **SNOOZE/DIMMER** to mute the alarm for nine minutes. The alarm can be muted as many times as you want within 59 minutes of the preset alarm time.
- 2 Press any button except **SNOOZE/DIMMER** to turn the alarm off for 24 hours.
- 3 To cancel the preset alarm, press **VOL -/Ⓜ** (or **VOL +/Ⓜ**). The **ALARM1** or **ALARM2** indicator turns off.

Play the radio

- 1 Press **⏻** (power) to turn on your clock radio, then press **AM/FM** repeatedly to select radio band you want to listen to.
- 2 If you select the FM band, stretch out the FM antenna on the back of your clock radio and move it around to improve FM reception.
-OR-
If you select the AM band, adjust the position of your clock radio for the best reception.
- 3 Press **TUNE ∇/∧** repeatedly to tune the radio to a lower or higher frequency.
- 4 Press and hold **TUNE ∇/∧** to search for the next available lower or higher station.







Note

The search may not stop at a station with a very weak signal.



- 5 Press **VOL -/Ⓜ** or **VOL +/Ⓜ** to decrease or increase the volume. Adjust the volume to a comfortable level.
- 6 Press **⏻** (power) to turn off your clock radio.

Use radio station presets





Your clock radio can store 20 station presets for AM and FM.

- 1 Press  (power) to turn on your clock radio, then press **AM/FM** repeatedly to select radio band you want to listen to.
- 2 Press **TUNE**  /  to tune your clock radio to the station you want to save.
- 3 Press and hold  / **MEM/PRESET**. The preset number blinks.
- 4 Press **TUNE**  /  repeatedly to select the preset number you want.
- 5 Press  / **MEM/PRESET** again to store the station as a preset. The preset number stops blinking.
- 6 Repeat steps 1 through 4 to save additional stations as presets.

Recall radio station presets

- 1 Press  (power) to turn on your clock radio, then press the **AM/FM** button repeatedly to select the radio band you want to listen to.
- 2 Press  / **MEM/PRESET** repeatedly to select the preset station you want.

Use the sleep timer

- 1 When listening to the radio, press the  (sleep) button repeatedly to set the sleep timer. Settings include **90 min, 60 min, 45 min, 30 min, 15 min, or OFF**. The radio automatically turns off after the specified amount of time.
- 2 After the sleep timer is activated, press  (sleep) to view the time remaining. You can change the sleep timer duration when the remaining time is displayed by pressing  (sleep) again.
- 3 To stop listening at any time, press  (power).

Clean your clock radio

- Use a soft, dry, clean cloth to clean the exterior of your clock radio.
- Do not let liquid drip into the inside of your clock radio.
- For stubborn stains, use a soft cloth dampened with a weak solution of mild detergent and water. Dry your clock radio immediately afterwards with a clean cloth. Do not use abrasive clothes, thinners, alcohol, or other chemical solvents, because they may damage the finish or remove the panel lettering.

Troubleshooting

Problem	Cause/Solution
No power	<ul style="list-style-type: none"> • Make sure the AC power adapter is connected securely and correctly to the power outlet. • Make sure that the power outlet is working.
No sound from the speakers	<ul style="list-style-type: none"> • Press VOL +/Ⓜ to increase the volume. • Make sure that the AC power adapter is connected securely and correctly to the power outlet. • Make sure that your clock radio is turned ON.
Static or noise when playing the radio	<ul style="list-style-type: none"> • Make sure that the station is tuned correctly and that the station has a good signal. • Try another station. • For FM stations, extend the antenna wire to improve the reception. • For AM stations, adjust the position of your clock radio for best reception.
The sound is distorted	<ul style="list-style-type: none"> • Make sure that the volume level is not set too high. • Make sure that the station is tuned correctly and that the station has a good signal.

Problem	Cause/Solution
The clock radio gets warm after extended play at high volume levels	<ul style="list-style-type: none"> This is normal. Turn down the volume to let the radio cool.

Specifications

Specifications are subject to change without notice.

Power requirement	AC 120V ~ 60 Hz
Power consumption	6W
Dimensions	7.9 x 3.2 x 3.2 in. (20 x 8.1 x 8.1 cm)
Tuner	Band: FM and AM Range: FM - 87.5~107.9 MHz AM - 520~1710 KHz Presets: 20 for AM and FM

Legal notices

FCC and IC Information:

This device complies with Part 15 of the FCC Rules. Operation is subject to the following two conditions: (1) This device may not cause harmful interference, and (2) this device must accept any interference received, including interference that may cause undesired operation.

This device complies with Industry Canada licence-exempt RSS standard(s). Operation is subject to the following two conditions: (1) this device may not cause interference, and (2) this device must accept any interference, including interference that may cause undesired operation of the device.

This equipment has been tested and found to comply with the limits for a Class B digital device, pursuant to Part 15 of the FCC Rules. These limits are designed to provide reasonable protection against harmful interference in a residential installation. This equipment generates, uses and can radiate radio frequency energy and, if not installed and used in accordance with the instructions, may cause harmful interference to radio communications. However, there is no guarantee that interference will not occur in a particular installation. If this equipment does cause harmful interference to radio or television reception, which can be determined by turning the equipment off and on, the user is encouraged to try to correct the interference by one or more of the following measures:

- Reorient or relocate the receiving antenna.
- Increase the separation between the equipment and receiver.
- Connect the equipment into an outlet on a circuit different from that to which the receiver is connected.
- Consult the dealer or an experienced radio/TV technician for help.

Warning: Changes or modifications not expressly approved by the party responsible for compliance could void the user's authority to operate the equipment.

This equipment complies with Industry Canada radiation exposure limits set forth for an uncontrolled environment.

IC Information:

CAN ICES-3 (B)/NMB-3

Information for Users on Disposal of Old Equipment

European Union

Note

This symbol is only valid in the European Union.



This symbol indicates that the electrical and electronic equipment should not be disposed as general household waste at its end-of-life. Instead, the product should be handed over to the applicable collection point for the recycling in accordance with your national legislation.

By disposing of this product correctly, you will help to conserve natural resources and will help prevent potential negative effects on the environment and human health that could otherwise be caused by inappropriate waste handling of this product. For more information about collection point and recycling of this product, please contact your local municipal office, your household waste disposal service or the shop where you purchased the product.

Penalties may be applicable for incorrect disposal of this waste, in accordance with national legislation.

Other Countries Outside the European Union

If you wish to dispose of this product, please do so in accordance with applicable national legislation or other rules in your country for the treatment of old electrical and electronic equipment.

One-year limited warranty - Insignia

Definitions:

The Distributor* of Insignia branded products warrants to you, the original purchaser of this new Insignia-branded product ("Product"), that the Product shall be free of defects in the original manufacturer of the material or workmanship for a period of one (1) year from the date of your purchase of the Product ("Warranty Period").

For this warranty to apply, your Product must be purchased in the United States or Canada from a Best Buy branded or Future Shop branded retail store or online at www.bestbuy.com, www.bestbuy.ca, or www.futureshop.ca and is packaged with this warranty statement.

How long does the coverage last?

The Warranty Period lasts for one year (365 days) from the date you purchased the Product. Your purchase date is printed on the receipt you received with the Product.

What does this warranty cover?

During the Warranty Period, if the original manufacture of the material or workmanship of the Product is determined to be defective by an authorized Insignia repair center or store personnel, Insignia will (at its sole option): (1) repair the Product with new or rebuilt parts; or (2) replace the Product at no charge with new or rebuilt comparable products or parts. Products and parts replaced under this warranty become the property of Insignia and are not returned to you. If service of Products or parts are required after the Warranty Period expires, you must pay all labor and parts charges. This warranty lasts as long as you own your Insignia Product during the Warranty Period. Warranty coverage terminates if you sell or otherwise transfer the Product.

How to obtain warranty service?

If you purchased the Product at a Best Buy or Future Shop retail store location, please take your original receipt and the Product to any Best Buy or Future Shop store. Make sure that you place the Product in its original packaging or packaging that provides the same amount of protection as

the original packaging. If you purchased the Product from a Best Buy or Future Shop online web site (www.bestbuy.com, www.bestbuy.ca, or www.futureshop.ca), mail your original receipt and the Product to the address listed on the web site. Make sure that you put the Product in its original packaging or packaging that provides the same amount of protection as the original packaging.

To obtain warranty service, in the United States call 1-888-BESTBUY, Canada call 1-866-BESTBUY for Future Shop call 1-800-663-2275. Call agents may diagnose and correct the issue over the phone.

Where is the warranty valid?

This warranty is valid only in the United States and Canada at Best Buy or Future Shop branded retail stores or websites to the original purchaser of the product in the county where the original purchase was made.

What does the warranty not cover?

This warranty does not cover:

- Customer instruction/education
- Installation
- Set up adjustments
- Cosmetic damage
- Damage due to weather, lightning, and other acts of God, such as power surges
- Accidental damage
- Misuse
- Abuse
- Negligence
- Commercial purposes/use, including but not limited to use in a place of business or in communal areas of a multiple dwelling condominium or apartment complex, or otherwise used in a place of other than a private home.
- Modification of any part of the Product, including the antenna
- Display panel damaged by static (non-moving) images applied for lengthy periods (burn-in).
- Damage due to incorrect operation or maintenance
- Connection to an incorrect voltage or power supply
- Attempted repair by any person not authorized by Insignia to service the Product
- Products sold "as is" or "with all faults"
- Consumables, including but not limited to batteries (i.e. AA, AAA, C etc.)
- Products where the factory applied serial number has been altered or removed
- Loss or Theft of this product or any part of the product

- Display panels containing up to three (3) pixel failures (dots that are dark or incorrectly illuminated) grouped in an area smaller than one tenth (1/10) of the display size or up to five (5) pixel failures throughout the display. (Pixel based displays may contain a limited number of pixels that may not function normally.)
- Failures or Damage caused by any contact including but not limited to liquids, gels or pastes.

REPAIR OR REPLACEMENT AS PROVIDED UNDER THIS WARRANTY IS YOUR EXCLUSIVE REMEDY FOR BREACH OF WARRANTY. INSIGNIA SHALL NOT BE LIABLE FOR ANY INCIDENTAL OR CONSEQUENTIAL DAMAGES FOR THE BREACH OF ANY EXPRESS OR IMPLIED WARRANTY ON THIS PRODUCT, INCLUDING, BUT NOT LIMITED TO, LOST DATA, LOSS OF USE OF YOUR PRODUCT, LOST BUSINESS OR LOST PROFITS. INSIGNIA PRODUCTS MAKES NO OTHER EXPRESS WARRANTIES WITH RESPECT TO THE PRODUCT, ALL EXPRESS AND IMPLIED WARRANTIES FOR THE PRODUCT, INCLUDING, BUT NOT LIMITED TO, ANY IMPLIED WARRANTIES OF AND CONDITIONS OF MERCHANTABILITY AND FITNESS FOR A PARTICULAR PURPOSE, ARE LIMITED IN DURATION TO THE WARRANTY PERIOD SET FORTH ABOVE AND NO WARRANTIES, WHETHER EXPRESS OR IMPLIED, WILL APPLY AFTER THE WARRANTY PERIOD. SOME STATES, PROVINCES AND JURISDICTIONS DO NOT ALLOW LIMITATIONS ON HOW LONG AN IMPLIED WARRANTY LASTS, SO THE ABOVE LIMITATION MAY NOT APPLY TO YOU. THIS WARRANTY GIVES YOU SPECIFIC LEGAL RIGHTS, AND YOU MAY ALSO HAVE OTHER RIGHTS, WHICH VARY FROM STATE TO STATE OR PROVINCE TO PROVINCE.

Contact Insignia:

For customer service please call 1-877-467-4289

www.insigniaproducts.com

INSIGNIA is a trademark of Best Buy and its affiliated companies.

Registered in some countries.

Distributed by Best Buy Purchasing, LLC

7601 Penn Ave South, Richfield, MN 55423 U.S.A.

©2014 Best Buy. All rights reserved.

Made in China

INSIGNIA™

INSIGNIA is a trademark of Best Buy and its affiliated companies.

Registered in some countries.

Distributed by Best Buy Purchasing, LLC

7601 Penn Ave South, Richfield, MN 55423 U.S.A.

©2014 Best Buy. All rights reserved.

Made in China

1-877-467-4289 (U.S. and Canada) or 01-800-926-3000 (Mexico)

www.insigniaproducts.com

V3 ENGLISH
14-0195

Free Manuals Download Website

<http://myh66.com>

<http://usermanuals.us>

<http://www.somanuals.com>

<http://www.4manuals.cc>

<http://www.manual-lib.com>

<http://www.404manual.com>

<http://www.luxmanual.com>

<http://aubethermostatmanual.com>

Golf course search by state

<http://golfingnear.com>

Email search by domain

<http://emailbydomain.com>

Auto manuals search

<http://auto.somanuals.com>

TV manuals search

<http://tv.somanuals.com>