

INSIGNIA™

DVD Player

NS-D160A14



Before using your new product, please read these instructions to prevent any damage.

Download from [Www.Somanuals.com](http://www.Somanuals.com). All Manuals Search And Download.

INSIGNIA™

Contents

Important Safety Instructions	4
Warnings	4
Introduction	5
DVD player components	5
Package contents:	5
Front	5
Back	5
Remote control	6
Using the remote control	7
Using the remote control for the first time	7
Replacing the battery	7
Making connections	7
What connection should I use?	7
Connecting power	8
Using component video (best)	8
Using composite video (good)	9
Connecting a home theater system using digital audio	9
Connecting a home theater system using analog audio	10
Using your DVD player	10
Playable discs	10
Playing a disc	10
Viewing JPEG pictures	10
Displaying disc information	11
Repeating a DVD chapter or CD track	11
Creating a playback loop (A-B repeat) on an audio CD	11
Using the on-screen menu	11
Language Setup menu	12
Screen Setup menu	12
Audio Setup menu	12
Maintenance	13
Handling discs	13
Cleaning discs	13
Troubleshooting	13
Resetting your DVD player	13

[Power 13](#)
[Video and audio 13](#)
[Operation 14](#)
[Specifications 14](#)
 [System and outputs 14](#)
 [Disc features 14](#)
 [General 15](#)
[Legal notices 15](#)
 [FCC Statement 15](#)
[ONE-YEAR LIMITED WARRANTY - INSIGNIA 17](#)

Important Safety Instructions



This symbol indicates that dangerous voltage constituting a risk of electric shock is present within your DVD player. This label is located on the back of your DVD player.



This symbol indicates that there are important operating and maintenance instructions in the literature accompanying your DVD player.



This symbol is the symbol for CLASS II (Double Insulation).



WARNING: Your DVD player employs a laser system.

Use of controls, adjustments, or the performance of procedures other than those specified may result in hazardous radiation exposure.

Visible laser radiation is present when open and interlocks defeated. **Do not stare into the beam.**

- 1 Read these instructions.
- 2 Keep these instructions.
- 3 Heed all warnings.
- 4 Follow all instructions.
- 5 Do not use this apparatus near water.
- 6 Clean only with dry cloth.
- 7 Do not block any ventilation openings. Install in accordance with the manufacturer's instructions.
- 8 Do not install near any heat sources such as radiators, heat registers, stoves, or other apparatus (including amplifiers) that produce heat.
- 9 Do not defeat the safety purpose of the polarized or grounding-type plug. A polarized plug has two blades with one wider than the other. A grounding type plug has two blades and a third grounding prong. The wide blade or the third prong are provided for your safety. If the provided plug does not fit into your outlet, consult an electrician for replacement of the obsolete outlet.
- 10 Protect the power cord from being walked on or pinched particularly at plugs, convenience receptacles, and the point where they exit from the apparatus.
- 11 Only use attachments/accessories specified by the manufacturer.
- 12 Use only with the cart, stand, tripod, bracket, or table specified by the manufacturer, or sold with the apparatus. When a cart is used, use caution when moving the cart/apparatus combination to avoid injury from tip-over.  S3125A
- 13 Unplug this apparatus during lightning storms or when unused for long periods of time.
- 14 Refer all servicing to qualified service personnel. Servicing is required when the apparatus has been damaged in any way, such as power-supply cord or plug is damaged, liquid has been spilled or objects have fallen into the apparatus, the apparatus has been exposed to rain or moisture, does not operate normally, or has been dropped.
- 15 The wall plug is the disconnecting device. The plug must remain readily operable.
- 16 An apparatus with a three-prong, grounding-type plug is a Class I apparatus, which needs to be grounded to prevent possible electric shock. Make sure that you connect this DVD player to a grounding-type, three-prong outlet.
- 17 The remote control battery should not be exposed to excessive heat such as sunshine, fire, or the like.
- 18 The apparatus should not be exposed to dripping or splashing, and no objects filled with liquids, such as vases, should be placed on the apparatus.

Warnings

Electric shock hazard

To reduce the risk of fire or electric shock, do not remove any cover or expose the device to rain or moisture. No user-serviceable parts are inside. Refer servicing to qualified service technicians.

Lightning

For added protection for your device receiver during a lightning storm, or when it is left unattended and unused for long periods of time, unplug it from the power outlet. This helps prevent property damage and personal injury from lightning and power line surges.

Replacement parts

When replacement parts are required, make sure that the service technician uses replacement parts specified by the manufacturer that have the same characteristics as the original part. Unauthorized substitutions may result in fire, electric shock, personal injury, or other hazards.

Safety check

After completing any service or repair to this device, ask the service technician to perform routine safety checks to determine that your DVD player is in correct operating condition.

Power source

Operate your DVD player only from the type of power source indicated on the marking label. If you are not sure of the type of power supplied to your home, consult an electrician or your local power company.

Insignia DVD Player

Introduction

Congratulations on your purchase of a high-quality Insignia product. Your NS-D160A14 DVD Player represents the state of the art in DVD player design and is designed for reliable and trouble-free performance.

DVD player components

Package contents:

- Insignia DVD player
- Remote control and battery
- AV cable
- *Quick Setup Guide*
- *Important Information*

Front

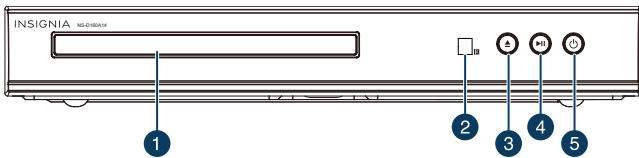

#	Item	Description
①	Disc tray	Insert a disc in this tray.
②	Remote control sensor	Receives signals from the remote control. Do not block.
③	▲ (open/close)	Press to open or close the disc tray.
④	▶▶ (Play/pause)	When a disc is in the disc tray, press to play or pause the disc. <ul style="list-style-type: none"> • Press to turn on your DVD player. • When your player is on, press and hold for three seconds to turn off (standby mode) your DVD player.
⑤	⏻ (Standby/On)	Warning: When your DVD player is off (standby mode), power still flows through it. To completely disconnect power, unplug the power cord.

Back

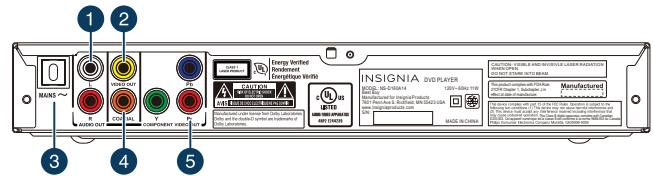

#	Item	Description
①	AUDIO OUT	Connect the analog audio jacks on a TV or home theater system to these jacks. For more information, see “Using component video (best)” on page 8, “Using composite video (good)” on page 9, or “Connecting a home theater system using analog audio” on page 10.
②	COMPOSITE VIDEO OUT	Connect the composite video jack on a TV to this jack. For more information, see “Using composite video (good)” on page 9.
③	Power cord	Plug the power cord into a power outlet. Warning: When your DVD player is off, power still flows through it. To completely disconnect power, unplug the power cord.
④	DIGITAL COAXIAL	Connect the digital coaxial audio jack on a TV or home theater system to this jack. For more information, see “Connecting a home theater system using digital audio” on page 9.
⑤	COMPONENT VIDEO OUT	Connect the component video jacks on a TV to these jacks. For more information, see “Using component video (best)” on page 8.

Remote control

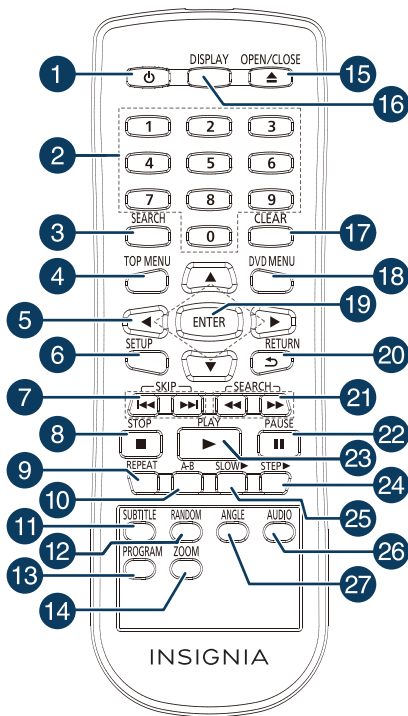

#	Item	Description
①	⏻ /STANDBY	Press to turn your DVD player on or off (standby mode). Warning: When your DVD player is off (standby mode), power still flows through it. To completely disconnect power, unplug the power cord.
②	Number buttons	Press to enter track/chapter/title numbers or a password.
③	SEARCH	Press to select a search point.
④	TOP MENU	(DVD only) Press to open the DVD title menu, if the DVD has one. Use ▲ ▼ ◀ ▶ to select an option, then press ENTER.
⑤	▲ ▼ ◀ ▶	Press to select options and settings.
⑥	SETUP	Press to open or close the on-screen menu.
⑦	◀◀ (previous) ▶▶ (next)	Press to go to the previous DVD chapter, CD track, or JPEG file. Press to go to the next DVD chapter, CD track, or JPEG file.
⑧	■ STOP	When playing a DVD or CD: <ul style="list-style-type: none"> Press once to stop playback. Press ▶ PLAY to resume playback. Depending on the disc, playback may resume where it stopped. Press twice to completely stop playback. Press ▶ PLAY to resume playback. Playback begins at the beginning of the disc. When viewing JPEGs, press to view thumbnails of the JPEGs. For more information, see " Viewing JPEG pictures " on page 10.
⑨	REPEAT	Press to repeat DVD chapters and titles or CD tracks. For more information, see " Repeating a DVD chapter or CD track " on page 11.
⑩	A-B	Press to repeat playback from point A to point B on a disc.
⑪	SUBTITLE	Press to select the subtitles to display.

#	Item	Description
⑫	RANDOM	Press to enable random playback.
⑬	PROGRAM	Press to set the playback order.
⑭	ZOOM	Press to change the aspect ratio of the display.
⑮	⏏ /OPEN/CLOSE	Press to open or close the disc tray.
⑯	DISPLAY	Press to display disc information, such as elapsed title or elapsed chapter time and remaining title or remaining chapter time. For more information, see " Displaying disc information " on page 11. When a music CD or JPEG disc is playing, press to display disc information.
⑰	CLEAR	Press to clear input information.
⑱	ENTER	Press to confirm selections.
⑳	↶ RETURN	Press to return to the previous display.
㉑	◀◀▶▶ (SEARCH)	Press to fast forward or fast reverse.
㉒	⏸ PAUSE	Press to pause playback.
㉓	▶ PLAY	Press to start playing a DVD, music CD, or JPEG disc.
㉔	STEP ▶	(DVD only) Press ▶ PLAY, then press this button to play the DVD one video frame at a time. Press ▶ PLAY to normal resume playback.
㉕	SLOW ▶	Press to start slow motion playback. Press ▶ PLAY to normal resume playback.
㉖	AUDIO	Press to change soundtracks.
㉗	ANGLE	Press to switch the camera angle. Not available on all discs.

Using the remote control

Using the remote control for the first time

The remote control comes with the battery already installed.

To use the remote control for the first time:

- 1 Press and hold the battery tray release tray tab while you pull the battery tray cover out of the remote control.

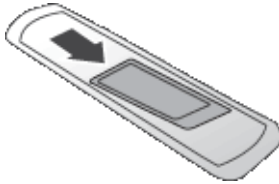

- 2 Remove the protective plastic sheet that covers the battery.
- 3 Slide the battery tray cover back into the remote control.

Replacing the battery

To replace the battery:

- 1 Press and hold the battery tray release tray tab while you pull the battery tray cover out of the remote control.

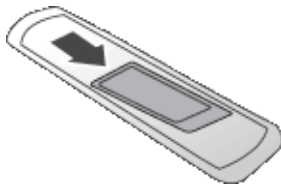

- 2 Remove the old battery.
- 3 Insert a new battery (AAA) into the battery tray. Make sure that the + symbol on the battery faces the direction indicated in the tray.

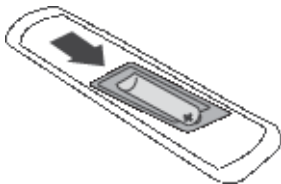

- 4 Slide the battery tray cover back into the remote control.

Cautions

- Make sure that you insert the battery correctly.
- Do not heat, open, or short-circuit the battery.
- Do not throw the battery into a fire.
- Replace the battery with a new AAA battery. Using the wrong type battery could cause an explosion or damage the remote control.
- If the remote control does not function correctly or if the operating range becomes reduced, replace the battery with a new one.

Making connections

What connection should I use?

Your DVD player has several connection types for connecting it to a TV.

For the best video quality, you should connect your DVD player to the best available connection.

Use the following tables to identify cables:

Connection type and jack	Video quality	Cable connector
--------------------------	---------------	-----------------

Component video (requires an audio connection)



Best

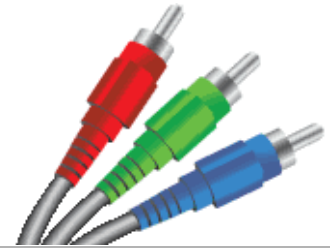

Composite video (requires an audio connection)



Good

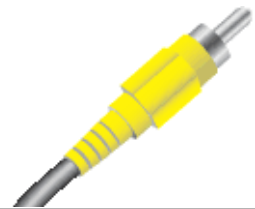

Connection type and jack

Cable connectors

Digital coaxial audio



Analog audio



Cautions

- Check the jacks for position and type before making any connections.
- Loose connections can result in image or color problems. Make sure that all connections are tight and secure.
- The external audio/video equipment shown may be different from your equipment. If you have questions, refer to the documentation that came with your equipment.
- Always unplug the power cord when connecting external equipment.

Connecting power

To connect power:

- Plug the power cord into a power outlet.

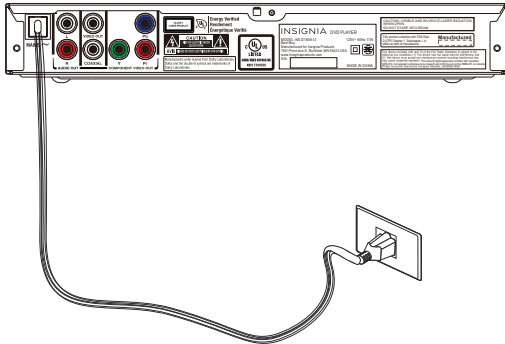

Cautions

- Your DVD player should only be operated from the power source indicated on the label.
- Always unplug the power cord from the power outlet when you will not be using your DVD player for an extended period of time.

Using component video (best)

To connect your DVD player using component video:

- 1 Make sure that the power cords for your DVD player and the TV are unplugged.
- 2 Connect a component video cable (not included) to the **COMPONENT VIDEO OUT** jacks on the back of your DVD player and to the component video in jacks on the back of the TV.

Cable connectors are often color-coded to match color-coded jacks.

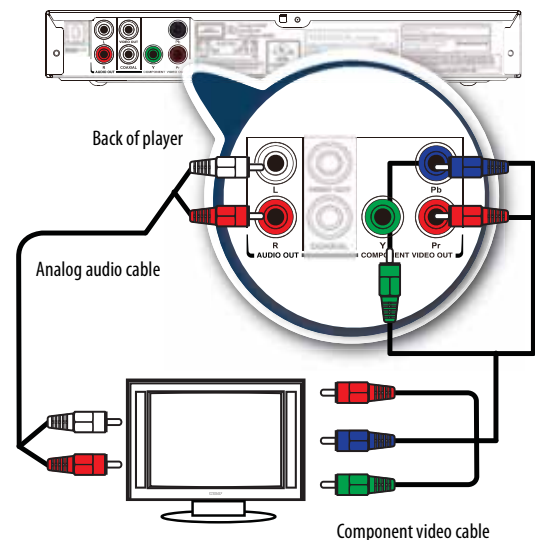

- 3 Connect an analog audio cable to the **AUDIO OUT** jacks on the back of your DVD player and to the audio in jacks on the TV.

Note

The **COMPONENT VIDEO OUT** jacks share the **AUDIO OUT** jacks with the **VIDEO OUT** jack.

- 4 Plug in the power cords, then turn on the TV and your DVD player.
- 5 Select the video input source on the TV that you connected your DVD player to. For more information, see the documentation that came with the TV.

Using composite video (good)

To connect your DVD player using composite video:

- 1 Make sure that the power cords for your DVD player and the TV are unplugged.
- 2 Connect an AV cable (not provided) to the **VIDEO OUT** jack and **AUDIO OUT** jacks on the back of your DVD player and to the composite video and audio in jacks on the TV.

Cable connectors are often color-coded to match color-coded jacks.

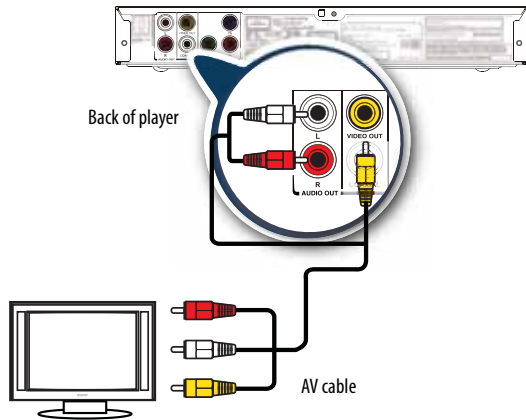

- 3 Plug in the power cords, then turn on the TV and your DVD player.
- 4 Select the video input source on the TV that you connected your DVD player to. For more information, see the documentation that came with the TV.

Note

The **VIDEO OUT** jack shares the **AUDIO OUT** jacks with the **COMPONENT VIDEO OUT** jacks.

Connecting a home theater system using digital audio

To connect a home theater system using digital audio:

- 1 Make sure that the power cords for your DVD player and the home theater system are unplugged.
- 2 Connect a digital coaxial audio cable (not provided) to the **DIGITAL COAXIAL** jack on the back of your DVD player and to the digital coaxial in audio in jack on the home theater system.

Cable connectors are often color-coded to match color-coded jacks.

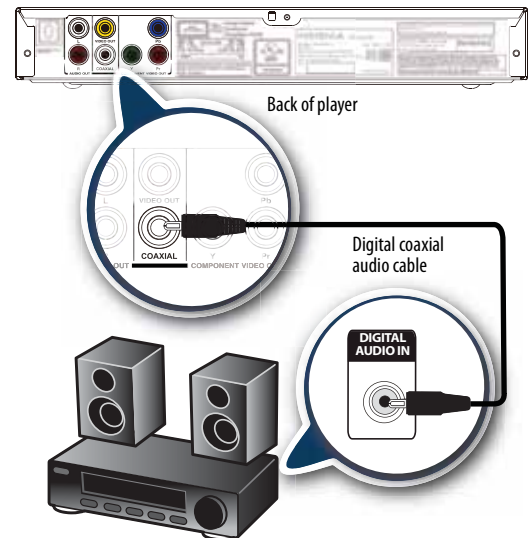

- 3 Plug in the power cords, then turn on the home theater system and your DVD player.

Connecting a home theater system using analog audio

To connect a home theater system using analog audio:

- 1 Make sure that the power cords for your DVD player and the home theater system are unplugged.
- 2 Connect an analog audio cable to the **AUDIO OUT** jacks on the back of your DVD player and to the analog audio in jacks on the home theater system.

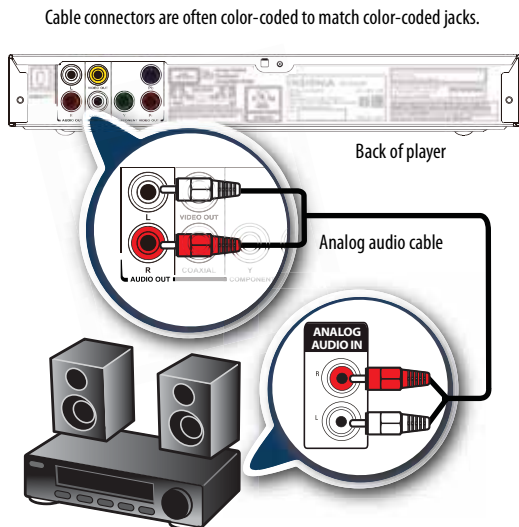

- 3 Plug in the power cords, then turn on the home theater system and your DVD player.

Using your DVD player

Playable discs

Disc type	Logo	Disc type	Logo
DVD-video (DVD-ROM)		Audio CDs (CDDA)	
DVD+R		CD-R	
DVD+RW		CD-RW	
DVD-R		JPEG/Kodak picture CD	
DVD-RW			

Playing a disc

To play a disc:

- 1 Turn on your DVD player and the TV.
- 2 Select the input source on the TV that you connected your DVD player to (component video or composite video).
- 3 Press **▲ OPEN/CLOSE** to open the disc tray.
- 4 Load the disc into the tray with the label side up.

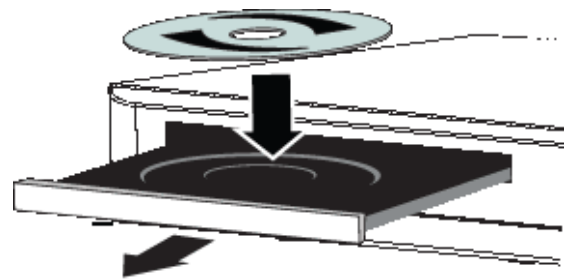

- 5 Press **▲ OPEN/CLOSE** to close the tray. Playback starts automatically. If playback does not start, press **▶ PLAY** on the remote control or the front of your DVD player to start playing the disc.

Note

While the disc is loading, you can press **▶||** (play/pause) on the front of your DVD player to pause the disc. When you are ready to play the disc, press **▶||** (play/pause).

If you pause the disc, then press and hold **⏻** (Standby/On) for three seconds, your DVD player goes into standby mode.

If your DVD player is in standby mode, press **⏻** (Standby/On) on the front of your DVD player to start playing the disc.

Viewing JPEG pictures

To view JPEG pictures:

- 1 Turn on your DVD player and the TV.
- 2 Select the input source on the TV that you connected your DVD player to (component video or composite video).
- 3 Press **▲ OPEN/CLOSE** to open the disc tray.
- 4 Load the disc containing JPEGs in the tray with the playable side facing down.

- 5 Press **▲ OPEN/CLOSE** to close the tray. The *Total Files* screen opens.



- 6 To view selected JPEGs, press **DVD MENU** to display a file list, use **▲ ▼ ◀ ▶** to select the JPEGs you want to view, then press **ENTER**. A slide show displays the files in the order you selected them.
- 7 To view thumbnails of the JPEGs, press **■ STOP**. Thumbnails of the JPEGs are displayed.



- 8 Press **▲ ▼ ◀ ▶** to select:

Displaying disc information

To display disc information:

- Press **DISPLAY** one or more times.

	Displays	Description
1st press	TT x/xx CH x/xx Title Elapsed xx:xx:xx	"TT x/xx" stands for the current title and total number of titles on the disc. "CH x/xx" stands for the current chapter and total number of chapters on the disc. "Title Elapsed xx:xx:xx" stands for the elapsed playing time for the current title.
2nd press	AUDIOX/X SUBTITLEX ANGLE XX	"AUDIOX/X" stands for the current AUDIO and total number of AUDIO on the disc. "SUBTITLEX/X" stands for the current SUBTITLE and total number of SUBTITLE on the disc. "ANGLEX/X" stands for the current ANGLE and total number of ANGLE on the disc
3rd press	NA	Closes the display.

Repeating a DVD chapter or CD track

To repeat a DVD chapter or CD track:

- To repeat a DVD title or chapter, press **↻/REPEAT** one or more times to select a repeat mode. The repeat sequence is:
 - Repeat the current chapter
 - Repeat the current title
 - Repeat all the titles on the DVD
 - Turn off repeat mode
- To repeat a CD track, press **↻/REPEAT** one or more times to select a repeat mode. The repeat sequence is:
 - Repeat the current track
 - Repeat all the tracks on the CD
 - Turn off repeat mode

Creating a playback loop (A-B repeat) on an audio CD

Note

DVD Discs do not normally support playback loops.

To create a playback loop:

- 1 Play the disc until you reach the point where you want the loop to start, then press **A-B**.
- 1 Play the disc until you reach the point where you want the loop to stop, then press **A-B**. Your player plays the loop you created repeatedly.
- 1 Press **A-B** to cancel the loop and return to normal playback.

Using the on-screen menu

To use the on-screen menu:

- 1 Press **SETUP**. The on-screen menu opens.



- 2 Press **▲** or **▼** to highlight a menu icon, then press **▶** to access the menu. You can select:
 - *Language Setup*—See "[Language Setup menu](#)" on page 12.
 - *Screen Setup*—See "[Screen Setup menu](#)" on page 12.
 - *Audio Setup*—See "[Audio Setup menu](#)" on page 12.
- 3 Press **▲** or **▼** to highlight a setting, then press **ENTER**.
- 4 If a setting has a submenu, press **▶** to open a submenu.
- 5 Press **▲** or **▼** to highlight a setting, then press **ENTER**.
- 6 To close the on-screen menu, press **SETUP**.

Language Setup menu

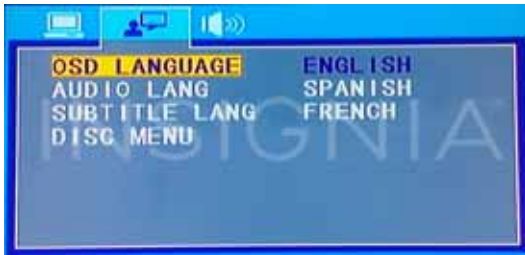

- **OSD LANGUAGE**—Selects the on-screen menu language. You can select **English, French, or Spanish.**
- **AUDIO LANG**—Selects the audio language for the DVD. Available languages vary from DVD to DVD.
- **SUBTITLE LANG**—Selects the DVD subtitle language. Available languages vary from DVD to DVD.
- **DISC Menu**—Select the DVD menu language. Available languages vary from DVD to DVD.

Screen Setup menu



- **TV TYPE**—Select how the picture looks on the screen (aspect ratio). You can select **4:3 Pan and Scan, 4:3 Letter Box, or 16:9 Wide.**

Aspect ratio option	Example
<p>4:3 Letter Box</p> <p>Displays the image in the original aspect ratio. Black bars appear if the image is not in the widescreen (16:9) aspect ratio.</p>	
<p>4:3 Pan & Scan</p> <p>Expands the image to fill the screen. The left and right portions of the image may be cropped.</p>	
<p>16:9 Wide</p> <p>Use this option to view content recorded in a 16:9 (wide-screen) aspect ratio.</p>	

Notes

- A DVD recorded in a 4:3 format is always displayed in a 4:3 aspect ratio.
- If a DVD is recorded in a 16:9 format and the TV has a 4:3-size screen, black bars appear at the top and bottom of the video image.
- Some DVDs may be recorded in a special format. These DVDs are displayed in their original formats.
- See the DVD packaging or documentation to determine what aspect ratio the DVD is recorded in.

- **P-SCAN**—Turns **Progressive Scan On or Off.** The progressive scan feature adjusts the TV screen resolution to provide a smoother, more theater-like image.
- **SCREEN SAVER**—Turns **Screen Saver On or Off.** When the screen saver is turned on and your DVD player is idle for about 3 minutes, an animated picture appears on the screen.
- **PASSWORD**—Sets the parental control password. The default password is **0000.** You should change the password to a number you can remember.
- **PARENTAL**—Allows you set the parental control screen. Parental controls cannot be changed if the device has been password locked. If the device is password unlocked, then changes to parental controls can be made.
- **MEMORY**—Turns **Playback Memory On or Off.** When the playback memory feature is turned on and you remove a DVD from the disc tray, then re-insert it, the DVD starts playing where it was stopped.
- **RESET**—Resets your DVD player's settings to the factory defaults. Select this option, then press **ENTER.**

Audio Setup menu

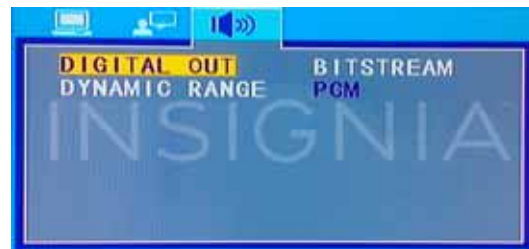

- **DIGITAL OUT**—Selects the audio output mode. You can select:
 - **BITSTREAM**—Outputs the movie soundtrack without any processing. This option requires a receiver or TV that supports the movie soundtrack format.
 - **PCM**—Outputs the signal as processed audio ready for any receiver. Use this when your receiver or TV cannot decode the movie soundtrack on the disc.
- **DYNAMIC RANGE**—Turns **Dynamic Range On or Off.** When the dynamic range feature is turned **Off,** movie soundtracks are played with the standard dynamic range.

When movie soundtracks are played at low volume or from smaller speakers, you can turn **On** the dynamic range feature. Your DVD player applies appropriate compression to make low-level content more intelligible and prevent dramatic passages from getting too loud.

Maintenance

Handling discs

- To keep a disc clean, do not touch the play side (non-label side) of the disc.
- Do not attach paper or tape to the disc.

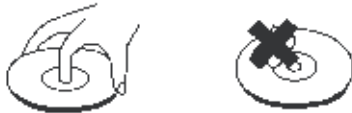

Cleaning discs

- Before playback, wipe the disc outwards from the center (not in a circle) with a clean cloth.



- If you cannot clean the disc with a dry cloth, wipe the disc with a slightly moistened, soft cloth, then dry it with a soft cloth.
- Do not use any solvents, such as paint thinner, benzine, commercially available cleaners, or anti-static spray designed for vinyl records.

Troubleshooting

Check the following information for the possible cause and solution for a problem before contacting the nearest service center or dealer for repairs. The following do not indicate a problem with your DVD player:

- Regular disc rotation sounds.
- Image disturbance during search.

Resetting your DVD player

Caution

Resetting your DVD player returns all settings to the factory defaults.

To reset your DVD player:

- 1 Press **SETUP**. The on-screen menu opens.
- 2 Press **▲** or **▼** to select **RESET**.
- 3 Press **ENTER** to highlight **RESTORE**, then press **ENTER**.

Power

Problem	Possible solution
No power	<ul style="list-style-type: none"> • Make sure that the power cord is securely connected to a power outlet. • Make sure that the power outlet is supplying power. Test the power outlet by plugging a device, such as a lamp, into the power outlet and turning it on.
The DVD player switches to standby mode	<ul style="list-style-type: none"> • After a period of inactivity, your DVD player switches to standby mode automatically. This is a power saving feature. If your DVD player switches to standby mode unexpectedly, a safety device may have been activated. Press ⏻ (Standby/On) on the front of your DVD player.

Video and audio

Problem	Possible solution
No picture	<ul style="list-style-type: none"> • Make sure that the TV is turned on and set to the correct video input for your DVD player. • Make sure that your DVD player is correctly connected to the TV.
Picture is distorted	<ul style="list-style-type: none"> • Make sure that the disc is not dirty. See "Cleaning discs" on page 13. • The DVD may be scratched or warped. Try another DVD. • Make sure that the TV is connected to the correct jacks on the back of your DVD player. • Make sure that the TV is set to the correct video input source. • Your DVD player may be experiencing interference from a nearby device, such as a TV, radio, or VCR. Try turning the devices off one at a time to find out which device is causing interference. Then move your DVD player and the device farther apart. • Turn off your DVD player, wait 10 seconds, then turn it back on.
No sound	<ul style="list-style-type: none"> • Make sure that the TV or home theater is turned on. • Make sure that the sound on the TV or home theater is not muted. • Make sure that the volume on the TV or home theater is turned up. • Make sure that your DVD player is correctly connected to the TV or home theater.
Audio and video pause momentarily	<ul style="list-style-type: none"> • This happens when your DVD player is changing chapters in a playlist. • When playing a disc that is recorded on both layers, audio and video may pause when your DVD player is changing layers.

Operation

Problem	Possible solution
Remote control does not work	<ul style="list-style-type: none"> The remote control comes with the battery installed. A plastic sheet covers the battery to protect it. Make sure that you remove the plastic sheet. See "Using the remote control for the first time" on page 7. Make sure that you are pointing the remote control at the remote control sensor on the front of your DVD player. See "Front" on page 5. Replace the dead battery with a new one. See "Using the remote control for the first time" on page 7. Make sure that there are no obstructions between the remote control and the remote control sensor on the front of your DVD player. Make sure that there is no colored glass between the remote control and remote control sensor on the front of your DVD player. Colored glass, such as the glass door of an entertainment center, can interfere with signal reception. Make sure that the remote control sensor is not exposed to direct sunlight or bright light. These can interfere with signal reception.
 appears on the screen	<ul style="list-style-type: none"> This symbol means that an action is not permitted by the disc. For example, some DVDs do not let you fast-forward through the legal warnings at the beginning of the disc.
Playback does not start, or starts then stops when pressing ► PLAY	<ul style="list-style-type: none"> Make sure the disc is face up in the disc tray. Make sure that the disc is not dirty. See "Cleaning discs" on page 13. Make sure the disc is not warped. Try another disc.
Some or all functions do not work	<ul style="list-style-type: none"> Some functions are not allowed by the disc, for example, fast-forwarding through the warning information at the beginning of the disc. Condensation may have formed inside your DVD player. Turn off your DVD player and wait one to two hours for the condensation to evaporate. Reset your DVD player. For instructions, see "Resetting your DVD player" on page 13.
When reading the disc, the disc tray opens	<ul style="list-style-type: none"> Make sure that the disc is not dirty. For instructions, see "Cleaning discs" on page 13. The disc may be incompatible with your DVD player. Try another disc. Reset your DVD player. For instructions, see "Resetting your DVD player" on page 13.
The DVD player freezes when reading a disc	<ul style="list-style-type: none"> Make sure that the disc is not dirty. For instructions, see "Cleaning discs" on page 13. If your DVD player freezes again, the disc may contain some content that is not compatible with your DVD player. Do not try playing the disc with your DVD player. Reset your DVD player. For instructions, see "Resetting your DVD player" on page 13.
DVD does not play	<ul style="list-style-type: none"> Make sure the disc has the correct region code. The DVD region code is "1" or "all."
No subtitles	<ul style="list-style-type: none"> Turn on subtitles. See "Language Setup menu" on page 12. Make sure the disc was recorded with subtitles. If the disc has subtitles, a subtitle option should appear in the disc's menu.
Resume function does not work	<ul style="list-style-type: none"> If you press ■ STOP twice, the resume information is erased. Some discs do not support the resume function.

Specifications

Specifications are subject to change without notice.

System and outputs

TV signal system	NTSC
Frequency response	CD: • 20Hz-20KHz (EIAJ) DVD: • 20Hz-22KHz (96KHz) (Sample result) • 20Hz-22KHz (48KHz) (Sample result)
S/N ratio	> 65 dB
Audio	MPEG LAYER2 standard
Audio output (analog)	Electrical level output: • 2.0 ± 0.2 V Resistance: • 10K Ω
Audio output (digital coaxial)	Electrical level output: • 0.5Vp-p Resistance: • 75 Ω
Video output	Electrical level output: • 1.0 ± 0.2 V Resistance: • 75 Ω Unbalanced negative
Component video (Y, CB,CR)	Electrical level output: • 0.7Vp-p Resistance: • 75 Ω

Disc features

Tray vs. slot load	Tray load
Disc capacity	1
Progressive scan	Yes
Skip protection	No audio skipping during CD playback under typical usage conditions
Optical disc support	Supports: CD Digital Audio 12 cm, CD-R, CD-RW, DVD-Video 12 cm, DVD-R, DVD-RW, DVD+R, DVD+RW, DVD-R DL Dual Layer, DVD+R Dual Layer
Audio decoder	Supports: CD Digital Audio, Dolby Digital
Digital audio output formats supported via coaxial output	Supports: Linear PCM 2 channel, Dolby Digital Does not support: DTS, DTS HD Master Audio
Digital audio decode capability (digital coaxial output)	Supports: Dolby Digital to 2-channel downmix PCM Does not support: DTS to 2-channel downmix PCM
Video decoder	Supports: DVD Video, JPEG Does not support: WMV (Window Media Video) 9.1, VCD 1.1, VCD 2.0, SVCD, DivX, or XviD

General

Power	110V ~ 60Hz
Power consumption	11 W
Dimensions H × D × W	1.67 × 10.63 × 7.95 inches (42.5 × 270 × 202 mm)
Weight	2.09 lbs. (0.95 kg)
Operating temperature	41°F to 95°F (5°C to 35°C)
Operating humidity	5% to 90%
Energy Star qualified	No

Legal notices

FCC Statement

This device complies with Part 15 of the FCC Rules. Operation is subject to the following two conditions: (1) this device may not cause harmful interference, and (2) this device must accept any interference received, including interference that may cause undesired operation

This equipment has been tested and found to comply with the limits for a Class B digital device, pursuant to Part 15 of the FCC Rules. These limits are designed to provide reasonable protection against harmful interference in a residential installation. This equipment generates, uses and can radiate radio frequency energy and, if not installed and used in accordance with the instructions, may cause harmful interference to radio communications. However, there is no guarantee that interference will not occur in a particular installation. If this equipment does cause harmful interference to radio or television reception, which can be determined by turning the equipment off and on, the user is encouraged to try to correct the interference by one or more of the following measure

- Reorient or relocate the receiving antenna
- Increase the separation between the equipment and receiver.
- Connect the equipment into an outlet on a circuit different from that to which the receiver is connected.
- Consult the dealer or an experienced radio/TV technician for help

Warning: Changes or modifications not expressly approved by the party responsible for compliance could void the user's authority to operate the equipment.

DHHS and FDA safety certification

This product is made and tested to meet safety standards of the FCC, requirements and compliance with safety performance of the U.S. Department of Health and Human Services, and also with FDA Radiation Performance Standards 21 CFR Subchapter J.

Canadian Notice

CAN ICES-3 (B)/NMB-3(B)

IC Statement

This device complies with Industry Canada licence-exempt RSS standard(s). Operation is subject to the following two conditions: (1) this device may not cause interference, and (2) this device must accept any interference, including interference that may cause undesired operation of the device. This equipment complies with IC radiation exposure limits set forth for an uncontrolled environment.

About copyright

This item incorporates copyright protection technology that is protected by U.S. patents and other intellectual property rights. Use of this copyright protection technology must be authorized by Rovi Corporation, and is intended for home and other limited viewing uses only unless otherwise authorized by Rovi Corporation. Reverse engineering or disassembly is prohibited.

Dolby Laboratories



Manufactured under license from Dolby Laboratories. Dolby and the double-D symbol are trademarks of Dolby Laboratories.

ONE-YEAR LIMITED WARRANTY - INSIGNIA

Definitions:

The Distributor* of Insignia branded products warrants to you, the original purchaser of this new Insignia-branded product ("Product"), that the Product shall be free of defects in the original manufacturer of the material or workmanship for a period of one (1) year from the date of your purchase of the Product ("Warranty Period").

For this warranty to apply, your Product must be purchased in the United States or Canada from a Best Buy branded or Future Shop branded retail store or online at www.bestbuy.com, www.bestbuy.ca, or www.futureshop.ca and is packaged with this warranty statement.

How long does the coverage last?

The Warranty Period lasts for 1 year (365 days) from the date you purchased the Product. Your purchase date is printed on the receipt you received with the Product.

What does this warranty cover?

During the Warranty Period, if the original manufacture of the material or workmanship of the Product is determined to be defective by an authorized Insignia repair center or store personnel, Insignia will (at its sole option): (1) repair the Product with new or rebuilt parts; or (2) replace the Product at no charge with new or rebuilt comparable products or parts. Products and parts replaced under this warranty become the property of Insignia and are not returned to you. If service of Products or parts are required after the Warranty Period expires, you must pay all labor and parts charges. This warranty lasts as long as you own your Insignia Product during the Warranty Period. Warranty coverage terminates if you sell or otherwise transfer the Product.

How to obtain warranty service?

If you purchased the Product at a Best Buy or Future Shop retail store location, please take your original receipt and the Product to any Best Buy or Future Shop store. Make sure that you place the Product in its original packaging or packaging that provides the same amount of protection as the original packaging. If you purchased the Product from a Best Buy or Future Shop online web site (www.bestbuy.com, www.bestbuy.ca, or www.futureshop.ca), mail your original receipt and the Product to the address listed on the web site. Make sure that you put the Product in its original packaging or packaging that provides the same amount of protection as the original packaging.

To obtain warranty service, in the United States call 1-888-BESTBUY, Canada call 1-866-BESTBUY for Future Shop call 1-800-663-2275. Call agents may diagnose and correct the issue over the phone.

Where is the warranty valid?

This warranty is valid only in the United States and Canada at Best Buy or Future Shop branded retail stores or websites to the original purchaser of the product in the county where the original purchase was made.

What does the warranty not cover?

This warranty does not cover:

- Customer instruction/education
- Installation
- Set up adjustments
- Cosmetic damage
- Damage due to weather, lightning, and other acts of God, such as power surges
- Accidental damage
- Misuse
- Abuse
- Negligence
- Commercial purposes/use, including but not limited to use in a place of business or in communal areas of a multiple dwelling condominium or apartment complex, or otherwise used in a place of other than a private home.
- Modification of any part of the Product, including the antenna
- Display panel damaged by static (non-moving) images applied for lengthy periods (burn-in).
- Damage due to incorrect operation or maintenance

- Connection to an incorrect voltage or power supply
- Attempted repair by any person not authorized by Insignia to service the Product
- Products sold "as is" or "with all faults"
- Consumables, including but not limited to batteries (i.e. AA, AAA, C etc.)
- Products where the factory applied serial number has been altered or removed
- Loss or Theft of this product or any part of the product
- Display panels containing up to three (3) pixel failures (dots that are dark or incorrectly illuminated) grouped in an area smaller than one tenth (1/10) of the display size or up to five (5) pixel failures throughout the display. (Pixel based displays may contain a limited number of pixels that may not function normally.)
- Failures or Damage caused by any contact including but not limited to liquids, gels or pastes.

REPAIR REPLACEMENT AS PROVIDED UNDER THIS WARRANTY IS YOUR EXCLUSIVE REMEDY FOR BREACH OF WARRANTY. INSIGNIA SHALL NOT BE LIABLE FOR ANY INCIDENTAL OR CONSEQUENTIAL DAMAGES FOR THE BREACH OF ANY EXPRESS OR IMPLIED WARRANTY ON THIS PRODUCT, INCLUDING, BUT NOT LIMITED TO, LOST DATA, LOSS OF USE OF YOUR PRODUCT, LOST BUSINESS OR LOST PROFITS. INSIGNIA PRODUCTS MAKES NO OTHER EXPRESS WARRANTIES WITH RESPECT TO THE PRODUCT, ALL EXPRESS AND IMPLIED WARRANTIES FOR THE PRODUCT, INCLUDING, BUT NOT LIMITED TO, ANY IMPLIED WARRANTIES OF AND CONDITIONS OF MERCHANTABILITY AND FITNESS FOR A PARTICULAR PURPOSE, ARE LIMITED IN DURATION TO THE WARRANTY PERIOD SET FORTH ABOVE AND NO WARRANTIES, WHETHER EXPRESS OR IMPLIED, WILL APPLY AFTER THE WARRANTY PERIOD. SOME STATES, PROVINCES AND JURISDICTIONS DO NOT ALLOW LIMITATIONS ON HOW LONG AN IMPLIED WARRANTY LASTS, SO THE ABOVE LIMITATION MAY NOT APPLY TO YOU. THIS WARRANTY GIVES YOU SPECIFIC LEGAL RIGHTS, AND YOU MAY ALSO HAVE OTHER RIGHTS, WHICH VARY FROM STATE TO STATE OR PROVINCE TO PROVINCE.

Contact Insignia:

For customer service please call 1-877-467-4289
www.insigniaproducts.com

INSIGNIA is a trademark of Best Buy and its affiliated companies.

Registered in some countries.

Distributed by Best Buy Purchasing, LLC

7601 Penn Ave South, Richfield, MN 55423 U.S.A.

©2014 Best Buy. All rights reserved.

Made in China

INSIGNIA™

1-877-467-4289 (U.S. and Canada) or 01-800-926-3000 (Mexico)
www.insigniaproducts.com

INSIGNIA is a trademark of Best Buy and its affiliated companies.
Registered in some countries.
Distributed by Best Buy Purchasing, LLC
7601 Penn Ave South, Richfield, MN 55423 U.S.A.
©2014 Best Buy. All rights reserved.
Made in China

V3 ENGLISH
14-1116

Free Manuals Download Website

<http://myh66.com>

<http://usermanuals.us>

<http://www.somanuals.com>

<http://www.4manuals.cc>

<http://www.manual-lib.com>

<http://www.404manual.com>

<http://www.luxmanual.com>

<http://aubethermostatmanual.com>

Golf course search by state

<http://golfingnear.com>

Email search by domain

<http://emailbydomain.com>

Auto manuals search

<http://auto.somanuals.com>

TV manuals search

<http://tv.somanuals.com>