

bifinett

KH 1160

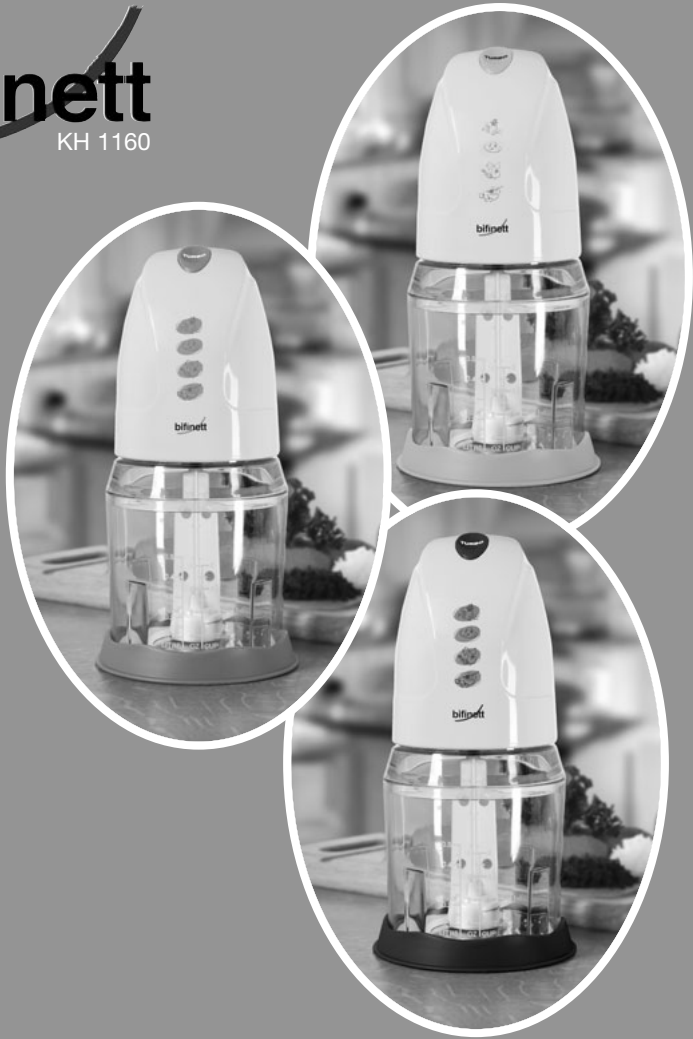

Operating and safety instructions

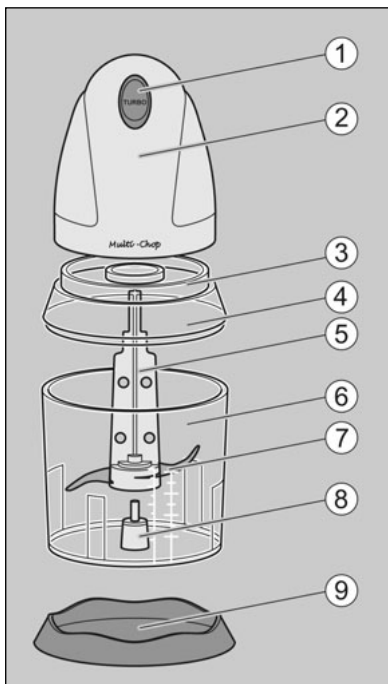

A

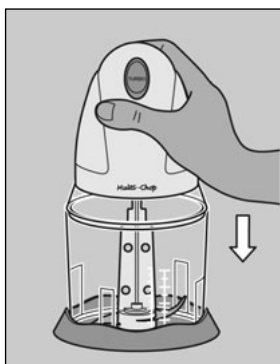

B

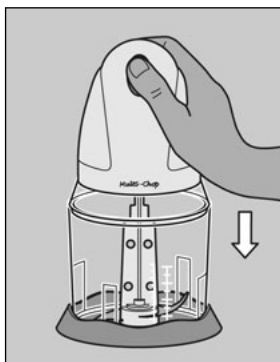

C

Table of Contents

Safety instructions	5
Proper use	6
Description	7
Included in delivery	7
Operation	7
Reducing the foodstuff into smaller pieces	9
Preparation table	9
Cleaning	10
Rectifying malfunctions	10
Disposal	11
Technical data	11
Guarantee and service	11
Manufacturer and Declaration of Conformity	11

Safety instructions

⚠ Danger of electric shock!

- Plug the food processor only in properly installed power sockets with a mains voltage of 230 V and 50 Hz.
- Pull the plug out of the power socket in case of malfunction and before cleaning the food processor.
- Do not submerge the food processor's motor unit in liquid at any time and do not allow any liquid to get into the motor unit's casing. Do not expose the appliance to dampness or use it outdoors. Should liquid happen to find its way into the appliance's casing, unplug the appliance immediately and have it repaired by a qualified professional.
- Never touch the food processor, power cord or plug when your hands are wet.
- Always unplug the power cord by grasping the plug, do not pull on the cord itself.
- Do not bend or crush the power cord; always place it in such a way that no one can step or trip on it.
- Should the power cord or motor unit be damaged, have the food processor repaired by a qualified professional before using it again. Do not open the food processor's motor unit casing. Safety cannot be ensured in this case, and the guarantee is no longer valid.
- Disconnect your food processor from the power supply immediately after use. The appliance is only completely switched off after having been unplugged.

⚠ Danger of injury!

- Keep the food processor out of reach of children at all times. Children may not use the appliance.
- There is danger of injuring yourself ⑦ when using the extremely sharp blade. Reassemble the food processor after using and cleaning it so that you do not injure yourself with the blade. Do not allow children to have access to the blade.

Fire hazard!

- Do not run the food processor for more than one minute at a time, turn it off for two minutes, otherwise it will overheat.

Caution!

- Never remove food from the processor bowl ⑥ when the blade is still moving. Contents could shoot out and make a mess.
- The processor bowl should never be more than two-thirds full. Otherwise there is danger of the contents squeezing out and making a mess.
- Washing the motor unit or the blade ② in the dishwasher will damage them.

Proper use

The food processor serves the sole purpose of reducing foodstuff into smaller pieces. This food processor is designed exclusively for use in private households. This also includes observance of all information in these operating instructions, particularly the safety instructions.

All other uses are deemed to be improper and can result in property damage or even in personal injury. **Kompertnaß** does not assume liability for damage caused by improper use.

Description

The food processor allows you to reduce foodstuff into smaller pieces. The turbo button (high-speed button) enables you to operate with more power.

Included in delivery

Figure A:

1	Turbo button	7	Blade
2	Motor unit	8	Bearing
3	Lid rim	9	Base
4	Lid	Guarantee (not illustrated)	
5	Blade holder	Operating instructions (not illustrated)	
6	Processor bowl		

Operation

i Before using the appliance for the first time, clean it thoroughly according to the instructions in the Cleaning chapter.

- ⇒ Place the processor bowl ⑥ in the base.
- ⇒ Place the blade stick ⑤ with the blade on the bearing ⑧.

i Please observe the recommendations concerning the quantity to be filled, processing time and speed in the preparation table.

- ⇒ Put the food in the processor bowl.
- ⇒ Close the processor bowl with the lid ④.
- ⇒ Put the motor unit ② on the rim of the lid ③.

- ⇒ Should the processing speed “low” be recommended in the preparation table for the food, press down the ② motor unit. Press as long as stated in the preparation table.

see figure B

- ⇒ Should the processing speed “turbo” be recommended in the preparation table for the foodstuff, press the turbo button ① in addition to the motor unit and keep it pressed.

see figure C

- ⇒ Should the processing speed “pulsing” be recommended in the preparation table, repeatedly press the turbo button quickly (in addition to the motor unit).
- ⇒ When the recommended processing time is over, let go of the motor unit and, if applicable, the turbo button.
- ⇒ Pull out the plug.

Danger of injury!

Never remove food from the processor bowl ⑥ when the blade ⑦ is still moving. There is danger of injury and the contents shooting out could make a mess.

- ⇒ Wait until the blade ⑦ has stopped moving.
- ⇒ Lift the motor unit from the rim of the lid ③.
- ⇒ Take off the lid ④ ab.

Danger of injury!

There is danger of injuring yourself ⑦ when using the extremely sharp blade. Do not allow children to have access to the blade.

- ⇒ Carefully remove the blade holder ⑤ with the blade from the processing bowl.
- ⇒ Remove the food.

⚠ Fire hazard!

Do not run the food processor for more than one minute at a time.
Turn it off for two minutes, otherwise it will overheat.

⇒ You may use the food processor again only after a cool-down time of two minutes.

Reducing the food into smaller pieces

⇒ Assemble the food processor as described in the chapter “Operating”.

⇒ Press down the motor unit ② as long as stated in the preparation table.

Preparation table

Food	Quantity (seconds)	Processing time speed	Processing
Bread crumbs	20 g	15	first low, then turbo
Meat	180 g	15	turbo
Spices	0.2 l	30	turbo
Gruyere cheese	100 g	15	turbo
Hardboiled eggs	200 g	10	turbo
Hazelnuts	100 g	15	turbo
Garlic	150 g	pulsing	low
Onions	200 g	pulsing	low
Almonds	100 g	15	turbo
Parsley	30 g	10	first low, then turbo
Shallots	200 g	30	low
Ham	200 g	15	turbo
Walnuts	100 g	15	turbo

Cleaning

Danger of electric shock!



Before cleaning the food processor, always unplug from the power socket.









Do not at any time submerge the appliance in water or hold it under running water when cleaning.

Danger of injury!

There is danger of injuring oneself  when using the extremely sharp blade. Reassemble the food processor after using and cleaning it so that you do not injure yourself with the blade. Do not allow children to have access to the blade.

Caution!

Washing the motor unit  or the blade  in the dishwasher will damage them.

-  Pull out the plug.
-  Reinigen Sie Motorblock , the blade holder  and the blade  with a sponge that has been wrung out well.
-  Wash the processor bowl , the lid  and the base  under running water and use a dry cloth to dry them.

Rectifying malfunctions

Symptom	Possible cause and remedy
The food processor will not turn on. reset them if necessary.	<p>A household fuse is defective. Check the fuses and</p> <p>The power socket is defective. Try another power socket.</p> <p>The food processor is possibly defective. Have the food processor inspected by a qualified professional.</p>

Disposal

Dispose the food processor Bifinett KH 1160 using a reliable waste disposal service or at your municipal waste disposal facilities. Do not on any account throw the food processor away with the normal household rubbish.

Please observe the current regulations in effect. In case of doubt, please contact your waste disposal facilities.

Technical data

Voltage	230 V~, 50 Hz
Rated power	260 W

Guarantee and service

Kindly consult the supplementary sheet Guarantee for the conditions of the guarantee and the service address.

Manufacturer and Declaration of Conformity

Kompernaß Handelsgesellschaft mbH, Burgstraße 21,
D-44867 Bochum, Germany, hereby declares this product to be in accordance with the following standards and directives:

- Low Voltage Directive 73/23/EEC
- EN 60335-1
- EN 60335-2-14
- Electromagnetic Compatibility (EMC) Directive 89/336/EEC
- EN 55014-1
- EN 55014-2
- EN 61000-3-2
- EN 61000-3-3

Type of Appliance/Type: KH 1160
Bochum, 17 October 2003



Hans Kompernaß, Managing Director

Free Manuals Download Website

<http://myh66.com>

<http://usermanuals.us>

<http://www.somanuals.com>

<http://www.4manuals.cc>

<http://www.manual-lib.com>

<http://www.404manual.com>

<http://www.luxmanual.com>

<http://aubethermostatmanual.com>

Golf course search by state

<http://golfingnear.com>

Email search by domain

<http://emailbydomain.com>

Auto manuals search

<http://auto.somanuals.com>

TV manuals search

<http://tv.somanuals.com>