

UK

KOMPERNASS GMBH • BURGSTRASSE 21 • D-44867 BOCHUM  
www.kompernass.com  
ID no.: KH1166-06/07-V1

**bifinett**



© **Microwave oven with grill function KH 1166**  
Operating Instructions

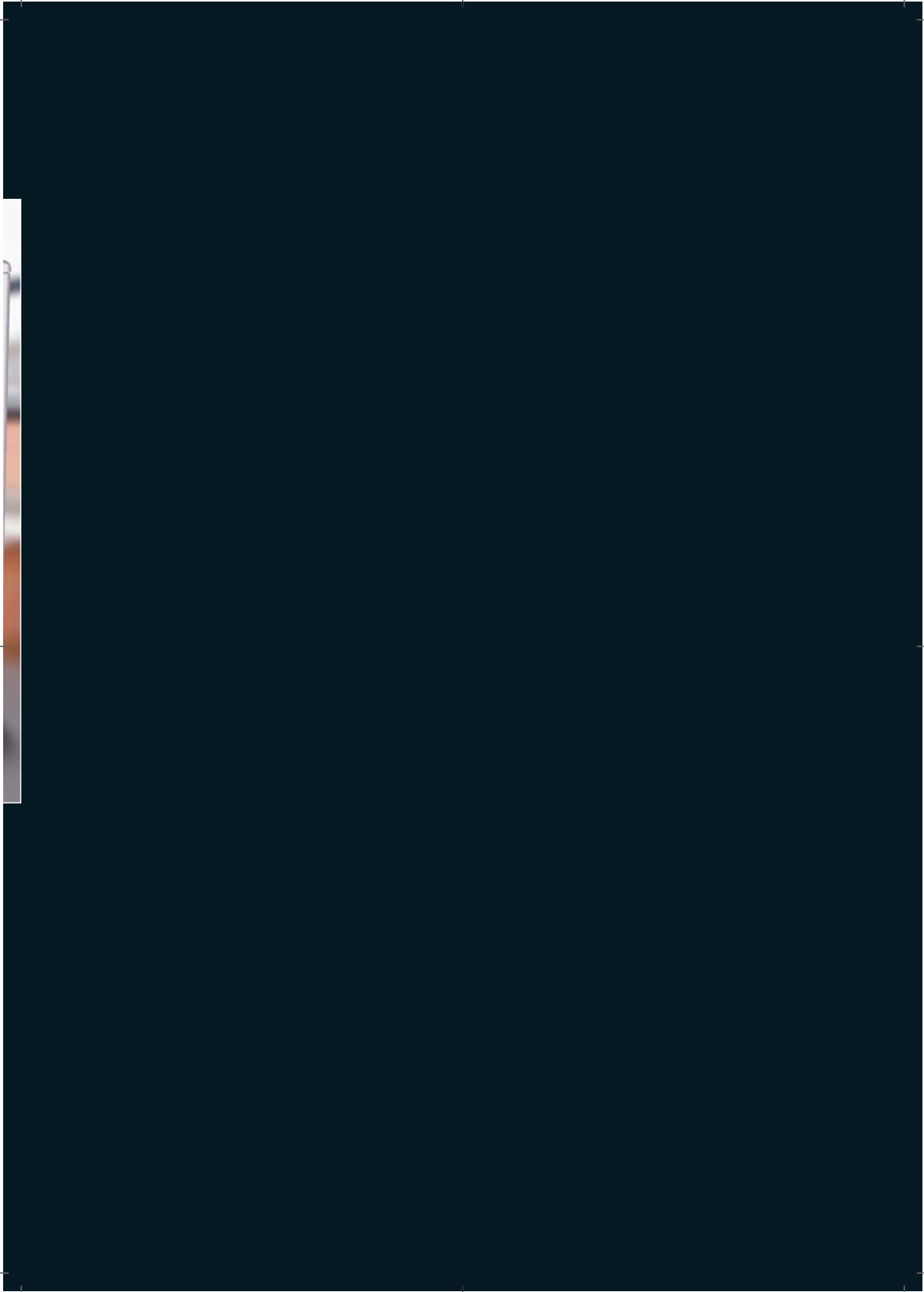

KH 1166

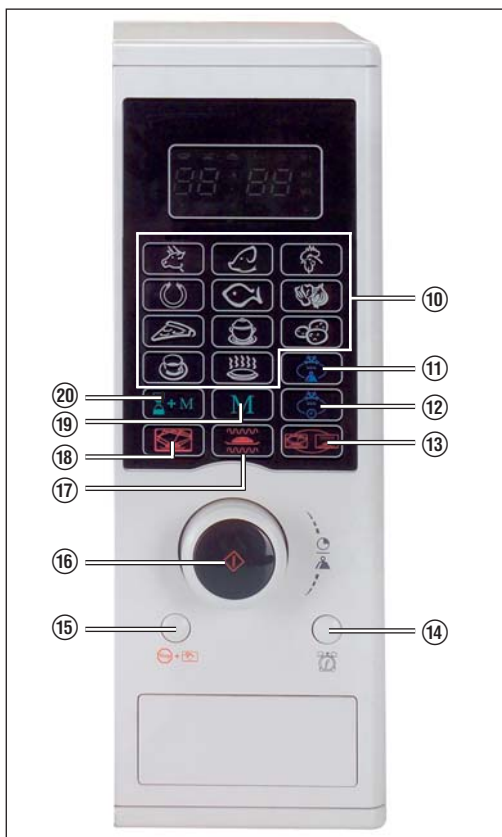

<b>Microwave oven with grill function KH 1166</b>	<b>Page</b>
<b>Introduction</b>	<b>5</b>
Proper Use	5
Package Contents	5
Description of Components	5
Buttons/controls on the control panel	5
Technical Data	5
<b>Safety</b>	<b>6</b>
Safety precautions for the avoidance of excessive contact with microwave energy	6
Important safety instructions	6
Earthing notice/Correct Installation	10
Interference with other appliances	10
<b>Installation of the appliance</b>	<b>10</b>
<b>Before you begin</b>	<b>11</b>
Basic principles of microwave cookery	11
Use suitable cookware	11
<b>Description of functions</b>	<b>12</b>
Setting the clock	12
Setting the kitchen timer	12
<b>Operation</b>	<b>13</b>
Cooking in the microwave oven	13
Quick start	14
Memory function	15
Selecting Pre-setting	15
Auto Menu	16
Grill function	18
Grill/Combi cooking procedure	19
Weight defrost	20
Jet defrost	20
Query functions	20
Child protection system	20
Power-save function	21
Acoustic signal function	21
<b>Cleaning and care</b>	<b>22</b>

KH 1166

<b>Disposal</b>	<b>23</b>
<b>Warranty &amp; service</b>	<b>23</b>
<b>Importer</b>	<b>23</b>
<b>Tips</b>	<b>23</b>
Freezing and thawing – the easy way ...	23
Cooking – the easy way ...	25
Grilling – the easy way ...	27
<b>Recipe suggestions</b>	<b>29</b>
<b>Pizza</b>	<b>29</b>
<b>Onionsoup with baked-over Cheese topping.</b>	<b>30</b>
<b>Lentil Hotpot</b>	<b>30</b>
<b>Cauliflower with gratinated cheese topping</b>	<b>31</b>
<b>Macaroni and minced meat casserole with broccoli</b>	<b>31</b>
<b>Fillet of pork with mushrooms in spicy paprika sauce</b>	<b>32</b>
<b>Potato gratin</b>	<b>32</b>
<b>Chicken Fricassee</b>	<b>33</b>
<b>Green chicken casserole</b>	<b>33</b>
<b>Bread or bacon dumplings</b>	<b>34</b>
<b>White sauce</b>	<b>34</b>
<b>Vanilla sauce</b>	<b>34</b>
<b>Rice pudding</b>	<b>35</b>
<b>Red fruit pudding (with strawberries and raspberries)</b>	<b>35</b>
<b>Index</b>	<b>36</b>

Read the operating instructions carefully before using the appliance for the first time and preserve this booklet for later reference. Hand over the manual to whomsoever you might pass the appliance on to.



## Microwave oven with grill function KH 1166

### Introduction

#### Proper Use

This appliance is intended for the heating up and preparation of foodstuffs according to the described procedures. Every modification to the appliance shall be deemed to be improper use and implies substantial danger of accidents. The manufacturer accepts no responsibility for damage(s) arising out of usage that is contrary to the instructions specified below. This appliance is not intended for commercial use.

#### Legend

-  Attention Warnings regarding damages to the appliance.
-  DANGER! Risk of injuries!
-  Notes! Note – Hints and tips for using the microwave.

#### Package Contents

 **Attention!** Plastic bags can present a danger. To avoid any danger of suffocation, keep this bag away from babies and children.

Immediately after unpacking the appliance, please ensure that the contents are complete and not damaged.

1 Microwave oven, Model KH 1166  
1 Turnable grill plate  
1 Metal rack for grill operation  
1 Operating manual  
1 Warranty booklet

### Description of Components

- ① Turnable grill plate
- ② Ventilation opening
- ③ LED display
- ④ Control panel
- ⑤ Control knob
- ⑥ Door opener
- ⑦ Safety door closure
- ⑧ Viewing window
- ⑨ Metal rack for grill operation

### Buttons/controls on the control panel

- ⑩ Key panel for eleven pre-programmed cooking functions (Auto Cook)
- ⑪ Weight Defrost
- ⑫ Jet Defrost
- ⑬ Grill/Combi
- ⑭ Clock/Kitchen timer
- ⑮ Cancel/Stop/Childlock
- ⑯ Start/Quickstart
- ⑰ Grill
- ⑱ Microwave
- ⑲ Memory
- ⑳ Pre-setting



This symbol on your microwave warns you of the danger of burns.

### Technical Data

Rated voltage:	230 V ~ 50 Hz
Power rating:	1300 W
Power output	
Microwave:	800 W
Power Consumption	
Grill:	1350 W
Interior volume:	approx. 20 l

KH 1166

## Safety

### Safety precautions for the avoidance of excessive contact with microwave energy

- Do not try to operate the appliance while the door is open, as this can lead to a damaging dose of microwave radiation. It is also important not to break open or manipulate the safety locks.
- Do not jam anything between the front of the appliance and the door, and make sure that there is no residual food or cleaning agent on the seals.

 **WARNING:** If the door or door seals are damaged, the oven must not be operated until it has been repaired by a competent person)

 **WARNING:** It is hazardous for anyone other than a competent person to carry out any service or repair operation that involves the removal of a cover which gives protection against exposure to microwave energy.

### Important safety instructions

When using electrical appliances, elementary safety precautions must be taken, including the following:

 **Danger:** To reduce the risk of burns, electric shock, fires, bodily injuries or excessive contact with microwave radiation:

Please read all instructions before using the appliance.

- Only use this appliance for its intended purpose as described in this manual. Do not use any caustic chemicals or vapours in this appliance. This microwave oven is especially designed for heating, cooking, grilling, or drying foodstuffs. It is not designed for use in industrial or laboratory areas.
- Do not use the microwave oven when it is empty.
- If the supply cord is damaged, it must be replaced by the manufacturer, its service agent or similarly qualified persons in order to avoid a hazard.
- Place the microwave oven so that there is a minimum distance of 20 cm to walls or cupboards. Ensure ventilation openings are always free. The microwave is not designed to fit into a kitchen unit.
- The AC power supply must be 230 V, 50 Hz, with a minimum 16 A distribution line fuse, or a minimum 16 A distribution circuit breaker. It is recommended that a separate circuit serving only this appliance be provided.
- Do not install the oven in an area of high humidity or where moisture may collect.
- Do not leave the oven unattended when using disposable plastic, paper or other combustible food containers.



- Do not place flammable materials near the oven or ventilation openings.
- Remove all metallic seals, wire twists, etc., from food and food packages. Arcing on metallic surfaces may cause a fire.
- To make popcorn, use only special microwave popcorn makers.
- Do not store food or any other items inside the oven.
- Check the settings after you start the oven to ensure the oven is operating as desired.
- Inside the oven cavity or on the door; make sure there are no dents.
- Do not allow grease or dirt to build up on the door seals and adjacent parts.
- Under no circumstances should you remove the outer cabinet. Never spill or insert any objects into the door lock openings or ventilation openings. In the event of a spill, turn off and unplug the oven immediately, and call an authorised service agent.
- Do not attempt to replace the oven lamp yourself or allow anyone who is not an electrician authorised to do so. If the oven lamp fails, please consult your dealer or an authorised service agent. If the power supply cord of this appliance is damaged, it must be replaced by an authorised service agent.
- Take care when microwaving liquids. Use a widemouthed container to allow bubbles to escape.
- To prevent sudden eruption of boiling liquid and possible scalding:
  - Stir liquid prior to heating/reheating.
  - It is advisable to insert a glass rod or similar utensil into the liquid whilst reheating.
  - Let liquid stand for at least 20 seconds in the oven at the end of cooking time to prevent delayed eruptive boiling.
- Pierce the skin of such foods as potatoes, sausages and fruit before cooking, or they may explode.
- To avoid burns, always test food temperature and stir before serving and pay special attention to the temperature of food and drink given to babies, children or the elderly. Temperature of the container is not a true indication of the temperature of the food or drink, always check the food temperature.
- Sliced stuffed baked foods after heating to release steam and avoid burns.
- Keep children away from the door, to prevent them burning themselves.
- Do not touch the oven door, outer cabinet, oven cavity, ventilation openings, bottom grill, accessories and dishes during grill, dual and automatic operation (except auto defrost) as they will become hot. Before cleaning make sure they are not hot.
- Only allow children to use the oven without supervision when adequate instructions have been given so that the child is able to use the oven in a safe way and understands the hazards of improper use.
- Do not lean or swing on the oven door. Do not play with the oven or use it as a toy.

KH 1166

- Children should be taught all important safety instructions: use of pot holders, careful removal of food coverings; paying special attention to packaging (e.g. self-heating materials) designed to make food crisp, as they may be extra hot.
  - Never modify the oven in any way.
  - Do not move the oven while it is in operation.
  - When using a browning dish or self-heating material, always place a heat resistant insulator such as a porcelain plate under it to prevent damage to the turntable due to heat stress. The preheating time specified in the dish's instructions must not be exceeded.
  - Do not use metal utensils, which reflect microwaves and may cause electrical arcing. Do not put cans in the oven.
  - Use only the turntable designed for this oven.
  - Do not place anything on the outer cabinet during operation.
  - Do not use plastic containers for microwaving if the oven is still hot from using the grill, dual and automatic operation (except auto defrost), because they may melt. Plastic containers must not be used during above modes unless the container manufacturer says they are suitable.
  - If you are unsure how to connect your oven, please consult an authorised, qualified electrician.
  - Water vapour or drops may occasionally form on the oven walls or around the door seals and sealing surfaces. This is a normal occurrence and is not an indication of microwave leakage or a malfunction.
  - The electrical outlet must be readily accessible so that the unit can be unplugged easily in an emergency.
  - Do not place the oven in areas where heat is generated. For example, close to a conventional oven.
  - Clean the waveguide cover, the oven cavity and the turntable after use. After cooking fatty foods without lid, always clean the cavity and especially the grill heating elements thoroughly. These must be dry and free from grease. Built-up grease may overheat and begin to smoke or catch fire.
  - Individuals with pacemakers should check with their doctor or the manufacturer of the pacemaker for precautions regarding microwave ovens.
  - Do not immerse the power supply cord or plug in water or any other liquid.
  - Do not let the power supply cord hang over the edge of a table or work surface.
  - Keep the power supply cord away from heated surfaces, including the rear of the oven.
  - Always open containers, popcorn makers, oven cooking bags, etc., away from the face and hands to avoid steam burns.
  - Always stand back from the oven door when opening it, to avoid burns from escaping steam and heat.
- ⚠ Danger:** Only permit children unsupervised use of the microwave oven when they have received adequate instruction in its operation. Children must understand the dangers from improper usage.

- To minimize the risk of fire in the microwave: When heating food in plastic or paper containers, always keep an eye on the microwave when it is in operation, as these materials can catch fire.
- Remove closures containing wire from paper or plastic bags, before placing them in the microwave.
- Should you notice smoke, switch the appliance off or pull the plug from the socket and keep the door closed to suffocate any possible flames.
- Do not use the interior of the microwave for storage purposes. Do not leave paper items, cooking utensils or food in the microwave when it is not being used.

**⚠ Important:** Liquids and other foods must not be heated in airtight containers, as these may explode and damage the appliance.

When heating beverages in the microwave, bubbling may be delayed when the drink boils. Therefore, be careful when handling the container.

- Do not fry in the microwave. Hot oil can damage parts of the appliance and utensils and even cause skin burns.
- Eggs in their shells and hard-boiled eggs should not be heated in the microwave, as they may explode, even after completion of the heating process.  
Food with thick skins, such as potatoes, whole pumpkins, apples and chestnuts must be pricked before cooking.

The content of babies' bottles or jars of baby food should be shaken or stirred.

**⚠ Danger:** Before feeding, check the temperature to avoid potentially lethal burns for babies.

Cooking utensils may become hot from the heat emitted by the food, so you may require oven gloves to touch them. In this case it should be checked if the cooking utensils are suitable for use in the microwave.

**⚠ Danger:** Microwave radiation is dangerous! Arrange for service and repair work, in which the coverings that protect you from contact with microwave radiation need to be removed, to be carried out only by trained specialists.

**⚠ Danger:** Inadequate cleanliness of the cooking appliance can lead to destruction of the upper surface, which on your part influences the total period of use and could possibly lead to dangerous situations.

KH 1166

### Earthing notice/Correct Installation

This appliance must be earthed. The appliance has a lead with an earthing wire and earthing connector. A correspondingly installed and earthed wall socket is required for this. In the case of a short circuit, earthing with the earthing cable reduces the risk of an electric shock. An individual circuit solely for the connection of the microwave is recommended. The use of high voltages is dangerous and can cause fires or other accidents, resulting in damage to the appliance.

**⚠ Danger:** Improper use of the earthing connector can cause the risk of an electric shock.

**ⓘ NOTE:** Should you have any questions about earthing or the instructions on the use of this electrical appliance, please consult an electrician or a maintenance technician.

Neither the manufacturer nor the dealer can accept liability for damage to the microwave oven or injury to persons resulting from failure to comply with the instructions for electrical connection.

### Interference with other appliances

The operation of the microwave can cause interference on your radio, television or similar appliances.

If such interference should occur, it may be reduced or corrected with the following remedial measures:

- Clean the door and the seal of the microwave.

- Re-align the receiver antenna of your radio or television.
- Position the microwave in a different place to the receiver.
- Move the microwave away from the receiver.
- Plug the microwave into another wall socket. The microwave and the receiver should be connected to different circuits.

### Installation of the appliance

- Choose an even surface offering enough space for the ventilation of the appliance.
- Ensure that you maintain a minimum distance of 20 cm from neighbouring walls/surfaces. Make sure that the door of the microwave oven can be opened easily.
- Ensure that the electrical plug is accessible without problem, so that in case of danger it can be easily reached and removed.
- Keep a gap of at least 20 cm free above the microwave.
- Do not remove the feet underneath the microwave.
- Do not block air supply and exhaust openings. Otherwise, it could cause damage to the appliance.
- Place the appliance as far away as possible from radios and TV sets. The operation of a microwave oven can cause disturbances to radio and TV reception.

- Connect the appliance to a standard household wall socket. Make sure that the voltage and frequency of the socket are compatible with the data printed on the nominal rating label.
- **⚠ Important:** Do not install the microwave above a cooker or any other appliance generating heat. Installation in such a location could cause damage to the appliance and lead to a subsequent lapse of warranty.
- Remove packaging material and any protective film on the surface of the casing.
- **ⓘ Note:** Do not remove the light grey flimmer cover plate, which is mounted in the cooking area to protect the magnetron!
- During the preparation of food in the microwave oven turn it once, so that dishes such as chicken or hamburger are "through" quicker.
- Large pieces of food, such as joints of meat, must be turned at least once.
- Completely re-arrange foods such as meatballs after half the cooking time. Turn them and move the meatballs from the middle of the cookware to the edge.

### Use suitable cookware

- The ideal materials for a microwave cooker are microwave permeable, that means, they permit the energy to pass through the container to heat the food. Microwaves cannot permeate metal. Therefore, metal containers and cookware should not be used.
  - When using the microwave for heating do not use products made of recycled paper. These can contain minute fragments of metal, which can generate sparks and/or fires.
  - We recommend the use of round/oval cookware instead of square or oblong containers, as food in corner areas tends to overcook. The following list is intended to assist you in selecting the correct cookware.
- 
- ### Before you begin
- 
- ### Basic principles of microwave cookery
- Arrange the food with consideration.
  - The thickest parts near the edges.
  - Pay attention to the cooking time. Select the shortest possible stated cooking time and increase as required. Food that is cooked too long can begin to smoke or catch fire.
  - Cover the food during cooking with a lid suitable for microwave cookery. The lid prevents splashing and helps in the even cooking of the food.

KH 1166

Cookware	Micro-wave	Grill	Combi-nation
Heat-resistant glass	Yes	Yes	Yes
Not heat-resistant glass	No	No	No
Heat-resistant ceramic	Yes	Yes	Yes
Microwaves suitable plastic tableware	Yes	No	No
Kitchen roll	Yes	No	No
Metal tray-/plate	No	Yes	No
Metal rack ⑨	No	Yes	No
Kitchen foil & Foil container	No	Yes	No
Turnable grill plate ①	Yes	Yes	Yes

## Description of functions

### Setting the clock

After inserting the mains plug into the socket, open the microwave door. The LED display reads "1:00". The oven emits an acoustic signal and switches into standby mode.

1. Press the button ⑭ „Clock/Kitchen Timer“ for ca. 3 seconds. In the LED display, the 24-hour modus is shown by „Hr 24“ If you want to change to the 12-hour modus, press the button ⑭ „Clock/Kitchen Timer“ once more. In the LED display the 12-hour modus is shown by „Hr 12“.



2. Turn the control knob ⑤, to programme in the hours.
3. Press the button ⑭ „Clock/Kitchen Timer“ and the minute details blink in the display.
4. Turn the control knob ⑤, to programme in the minutes.
5. To finish, press the button ⑭ „Clock/Kitchen Timer“.

**i Note:** When you press the button "Cancel/Stop/Childlock" ⑮, the appliance returns automatically to standby status.

### Setting the kitchen timer

The microwave has a kitchen timer, which you can use independently of microwave operation.

1. Press the button ⑭ „Clock/Kitchen Timer“ when the appliance is in standby/cooking operation. In the LED display „0:00“ appears, the colon flashes and the red clock symbol  lights up.
2. Programme in the time with the control knob ⑤.  
You can select any time range from 5 seconds to 95 minutes.
3. Press the button ⑮ „Start/Quickstart“. An acoustic signal sounds and the time starts to count down.



After 5 seconds the time appears on the LED display and the red clock symbol  switches off. The Kitchen Timer continues to count further. 5 seconds before expiration of the time period, the Kitchen Timer and the red clock symbol  appear again.

You can check the progress of the Kitchen Timer at any time by simply pressing the button  „Clock/Kitchen Timer“.





As soon as the programmed time has expired, an acoustic signal sounds two times..

## Operation

### Safety Door Closure

Press the door opener  to open the door. If the door is opened during operation, the cooking process is interrupted, the program or function, however, remain. The cooking process is continued when the door has been closed and the button "Start/Quickstart"  has been pressed.



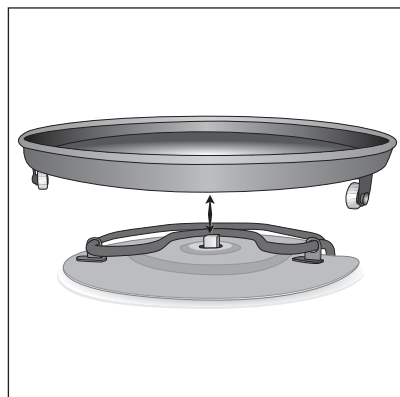

### Turnable grill plate

Place the turnable grill plate  so that the post in the middle of the microwave oven inserts itself exactly into the depression on the underside of the turnable grill plate . Always leave the turnable grill plate  in the appliance during use. The motion of the turnable grill plate  ensures an even distribution of energy and microwaves.



When a microwave process (cooking, grilling, thawing) is complete, five acoustic signals are sounded and "End" and "Hot" appear alternatively in the LED display.

### Cooking in the microwave oven

-  Before the first usage, switch on the grill function "bottom heat" at the highest rating: Press the Grill button  three times. In the display the symbol for "bottom heat" in the grill function appears . Using the control knob  set it to 10 Minutes. Press the Start/Quickstart button . As the heating element is lightly greased, the creation of odours can occur. This is harmless and stops after a short time. Provide for sufficient ventilation. Open a window.

When you want to use the classical basic functions of microwaving (warming, boiling, cooking), you must merely select the microwave power level and programme the desired cooking time. You can choose between eight power levels, from 800 to 100 watts, with a maximum cooking time of 95 minutes.

KH 1166

**1) Select power**

- Press the button  „Microwave“ the required number of times to select the Power Level.
- **1x** for 800 watt power.
- **2x** for 700 watt power.
- **3x** for 600 watt power.
- **4x** for 500 watt power.
- **5x** for 400 watt power.
- **6x** for 300 watt power.
- **7x** for 200 watt power.
- **8x** for 100 watt power.

The power is shown in the LED display (e.g. P 800 at 800 watts power).



**2) Setting the cooking time**

Turn the control knob  to set the cooking time.

**The increments for setting the time with the control knob are as follows:**

- from 0 to 1 min: in 5 second increments
- from 1 to 5 min: in 10 second increments
- from 5 to 10 min: in 30 second increments
- from 10 to 30 min: in 1 minute increments
- from 30 to 95 min: in 5 minute increments

**3) Start the cooking process**

To start the cooking process press the button  „Start/Quickstart“. The symbol for microwave operation  appears in the LED display. The count down begins.



**Interrupting the process (Cancel/Stop)**

You can stop a process, interrupt it and then continue.

**Aborting/stopping an input process**

Press the button  „Cancel/Stop/Child-lock“ once to break off and to finish an input process. The appliance switches back to standby mode.

**Interrupting the cooking process**



Press the button  „Cancel/Stop/Child-lock“ once, to interrupt a cooking process. The appliance interrupts the cooking process and stops the remaining time. Press the button  „Start/Quickstart“ to recommence the cooking process.

**Abort the cooking process**

Press the button  „Cancel/Stop/Child-lock“ twice to abort a cooking process. The appliance switches back to standby mode.

**Quick start**

With this function you can begin cooking at 100 % Power without delay.

- Programme in the desired time with the control knob .
- Press the button  „Start/Quickstart“. The symbol for microwave operation  appears in the LED display.  
The count down begins.

Or...



- Press button ⑯ „Start/Quickstart“. In the LED display the symbol for microwave operation  appears. The time period is automatically set to 30 seconds and counts down. Every time button ⑯ "Start/Quickstart" is pressed the cooking time increases itself by 30 seconds

### Memory function

Use the memory function if you wish to carry out 3 processes, one after the other. If you choose several operations and one of them includes thawing, thawing must be set as the first in the sequence.

After finishing a process, the acoustic signal sounds once, then the next process immediately starts.

- ① **NOTE:** The thawing programme should always be entered in as the first one.
- ① **NOTE:** „Weight defrost“ and „Auto Menu“ cannot be programmed.

### Example

You would like to prepare some food by using thaw for 15 minutes + 10 minutes of 600 Watt microwave power for cooking + 10 minutes grilling with top and bottom heat.

1. Press the button ⑫ „Jet Defrost“ and adjust the thawing time to 15 minutes with the control knob ⑤. „M1“ appears in the LED display.
2. Press the button ⑰ „Memory“ „--:--“ lights up in the display and „M2“.

3. Press the button ⑱ „Microwave“ three times to programme 600 Watt Power for cooking. "P600" is displayed in the LED display.
4. Turn the control knob ⑤ to the cooking time (Period: 10:00).
5. Press the button ⑲ „Memory“. „--:--“ appears in the display and „M3“.
6. Press the button ⑳ „Grill“ twice to programme to top and bottom grill.
7. Turn the control knob ⑤ to the grilling time.(Period: 10:00).
8. Press the button ⑯ „Start/Quickstart“, to activate the preadjustments.

### Selecting Pre-setting

With this program you can preset a specific starting time for cooking or grilling food.

If you have correctly adjusted the settings, the appliance will automatically start at the set time.

- ① **Note:** The clock must be pre-set in order to be able to select the function "Pre-setting".

1. Select the desired microwave function (thawing, cooking or grilling):  
For microwaving: Press the button ⑱ „Microwave“ as required to select the required Power Level. Programme the cooking time with the control knob ⑤.  
For grilling: Press the button ⑳ „Grill“ as required to activate the Grill Function.  
Programme the desired grilling time with the control knob ⑤.  
For thawing: Press the button ⑫ „Jet Defrost“.

KH 1166

Programme the desired thawing time with the control knob ⑤.

2. Press the button ⑳ „Pre-setting“. The LED display shows the actual programmed time, the hour-figures flash and the Egg-Timer symbol ⌚ appears.
3. Turn the control knob ⑤ to programme the hours.
4. Press the button ⑳ „Pre-setting“, now the minute-figures flash.
5. Turn the control knob ⑤ to programme the minutes.
6. Press the button ⑯ „Start/Quickstart“. The Egg-Timer symbol ⌚ flashes. The microwave oven automatically starts the procedure at the programmed times.

#### Example:

It is 12:30 a.m. You wish to heat your food at 12:45 a.m., automatically at 400 watts power for 10 minutes.

1. Press the button ⑯ „Microwave“ five times, to select the power level of P400.
2. Programme in 10 minutes with the control knob ⑤.
3. Press the button ⑳ „Pre-setting“. The LED display shows the actual programmed time (12:30), the Egg-Timer symbol ⌚ appears and the hour-figures flash.
4. Press the button ⑳ „Pre-setting“ again and, with the control knob ⑤, programme the minutes to „:45“.
5. Press the button ⑯ „Start/Quickstart“, to start the programmed procedure. The Egg-Timer symbol ⌚ flashes.

## Auto Menu

For foods that are intended to be prepared in the Auto Menu modus it is not necessary to programme in the period of the cooking process and the power level. It is sufficient to give the type of food that is to be prepared together with the weight of this food.

For this, press the respective button on the key panel ⑩, on which the food-stuffs are depicted. Thereupon, the weight of the item must be programmed in with the control knob ⑤.

### Enter the weight of the food

The weight is important to determine the necessary cooking time

After having pressed the respective symbol, a weight appears on the LED display in grams "g"; for entrees the number of portions, and for beverages in "ml". Using the control knob ⑤ amend the respective details. As soon the weight of the food is displayed, press the button ⑯ „Start/Quickstart“. „Auto-Cook“ <sup>AUTO</sup>COOK und „M1“ appear in the LED display.











**ⓘ Note:** With some foods, for example beef, pork, poultry and sausage, it is necessary to turn the food after about 1/2 of the cooking time. The acoustic signal sounds five times and "turn" appears on the display for 30 seconds, to remind you to turn the food.

1. The cooking process is interrupted by pressing button ⑮ „Cancel/Stop/Childlock“. Open the door and turn the food over.
2. To continue, close the door. Press the button ⑯ „Start/Quickstart“. The microwave automatically resumes operation for the remaining time.

**Tip:** If you wish to dispense with turning the food, wait until after the signal tone has sounded. The microwave cooker automatically continues its programme.

**Note:** We recommend that you do turn the food. This will ensure even cooking. However, when turning, make sure that you are extremely careful - you will be handling very hot foods in the microwave.

Your microwave oven can cook different types of food of following weights:

Type of food	Symbol	Weight	turn over after...
Beef		100 - 1500 g	1/2 of cooking time
Pork		100 - 1500 g	1/2 of cooking time
Poultry		400 - 1400 g	1/2 of cooking time
Sausage		100 - 500 g	1/2 of cooking time
Fish		100 - 1200 g	-
Vegetables/fruit		100 - 1000 g	-
Pizza		P1 150 - 900 g P2 150 - 900 g P3 300 - 900 g	-
Entrees		1 - 2 portions	-
Potatoes		100 - 800 g	-
Beverages		200 - 500 ml	-
Auto warming		300 - 700 g	-

**Note:** The acoustic tone sounds five times to remind you to turn the food.

KH 1166

**Example 1:**

Proceed as follows to cook 400 g vegetables or fruit:

1. Press button "Vegetables/fruit" in standby mode.
2. Select with the control knob ⑤ „400 g“.
3. Press the button ⑯ „Start/Quickstart“.

**Example 2:**

To heat 300 ml water, proceed as follows:

1. Press button "Beverages" in standby mode.
2. Select with the control knob ⑤ „300 ml“.
3. Press the button ⑯ „Start/Quickstart“.

**Example 3:**

Proceed as follows if you want to heat-up two Entrees:

1. Press button "Entrees" in standby mode.
2. Select with the control knob ⑤ „2“.
3. Press the button ⑯ „Start/Quickstart“.

**baking Pizza**

You can some oil on the surface of the turntable grill plate and then prepare the crispy Pizza in the microwave oven. The button „Pizza“ is used for this. Press the button "Pizza" on the key panel ⑩:

- once for frozen pizza, temperature approx. -18° / weight 150 g - 900 g ( "P-1" appears on the LED display)
- twice for chilled pizza, temperature approx. 5° / weight 150 g - 900 g ( "P-2" appears on the LED display)
- three times for fresh pizza, temperature approx. 20° / weight 300 g - 900 g ( "P-3" appears on the LED display)

**Example:**

Proceed as follows if you wish to cook a pizza:

1. Lay the Pizza in the turnable grill plate. ①.
2. Press the button „Pizza“ once. The LED displays "P-1". ("P-2" or "P-3" if the button is pressed twice or three times respectively)
3. Turn the control knob ⑤, to programme in the weight of the Pizza.
4. Press the button ⑯ „Start/Quickstart“ to start the grill process. The LED displays the time.

**i Tip:** Depending on the type of pizza and personal taste, it may be necessary to extend the baking time. For this, read the Chapter „Grill Function“.

**Grill function**





You can use the Grill Function ⑰ for thin slices of meat, steaks, rissoles, sausages or chicken pieces. It is also suitable for toasted sandwiches, gratins and for the baking of crispy rolls.

**⚠ Warning!** Cooking space, appliance door, exterior sides, turnable grill plate ①, metal rack ⑨, crockery and especially the heating coils under the turnable grill plate ① will be very hot.

**⚠ Risk of Burning!** To avoid burns, always use oven cloths, oven gloves or similar items when removing the food and the turnable grill plate ①.

You can select between three types of grilling: Top heat, bottom heat or top and bottom heat.



Always use the metal rack ⑨ when grilling with top heat. To achieve optimal grill results:

1. Press the button ⑰ „Grill“ once to activate the Grill Function „top heat“.  
The red symbol for Grill Function „top heat“  appears in the LED display.
2. Press the button ⑰ „Grill“ twice to activate the Grill Function „Top and bottom heat“.  
The red symbols for Grill Function „Top and bottom heat“  and  appear in the LED display.
3. Press the button ⑰ „Grill“ three times to activate the Grill Function „bottom heat“.  
The red symbol for Grill Function „bottom heat“  appears in the LED display.
4. With the control knob ⑤ set the desired cooking time. The maximum possible cooking time is 95 minutes.
5. To start the Grill Function press the button ⑱ „Start/Quickstart“.



### Grill/Combi cooking procedure

This function combines the grilling function with normal microwave operation. In combined mode, the microwave automatically cooks for a certain amount of time and grills for the remaining time. You may notice a quiet clicking noise when the oven is switching between modes.



### Grill/Combi 1

1. Press the button ⑬ „grill/Combi“ once. The red symbol for microwave operation  and the Grill Function „Top heat“  appear in the LED display.
2. Using the control knob ⑤ programme in the desired cooking time. The maximum possible cooking time is 95 minutes.
3. To start, press the button ⑱ „Start/Quickstart“.

### Grill/Combi 2

1. Press the button ⑬ „Grill/Combi“ twice. The red symbol for microwave operation  and the Grill Function „Top and bottom heat“  and  appear in the LED display.
2. Using the control knob ⑤ programme in the desired cooking time. The maximum possible cooking time is 95 minutes.
3. To start, press the button ⑱ „Start/Quickstart“.



### Grill/Combi 3

1. Press the button ⑬ „Grill/Combi“ three times. The red symbols for microwave operation  and Grill Function „bottom heat“  appear in the LED display.
2. Using the control knob ⑤ programme in the desired cooking time. The maximum possible cooking time is 95 minutes.
3. To start, press the button ⑱ „Start/Quickstart“.

KH 1166

## Weight defrost

With this function you can thaw meat, poultry and fish without problem. The thawing time and the power level are automatically calculated and adjusted on entering details of the weight.



1. Press the button (11) „Weight defrost“:  
„ : “ flashes in the LED display and the red symbol „Thaw“ , „Auto Cook“  and „M1“ appear.
2. Select the foodstuff to be thawed on the key panel for pre-selected cooking functions (10) (Auto Cook). Exempt from this function are the cooking functions beverages, entrees and auto warming.
3. Enter the weight using the control knob (5).
4. To start the process of thawing by weight, press the button (16) „Start/Quickstart“. The calculated time is counted down.

**i Note:** With some foods, such as meats, poultry, fish, vegetables and sausage it is necessary to turn the food after a certain period. The acoustic signal sounds five times and "turn" appears on the display for 30 seconds, to remind you to turn the food.

1. The cooking process is interrupted by pressing button (15) „Cancel/Stop/Childlock“. Open the door and turn the food over.
2. To continue, close the door. Press the button (16) „Start/Quickstart“. The microwave automatically resumes operation for the remaining time.

**i Tip:** If you wish to dispense with turning the food, wait until after the signal tone has sounded. The microwave cooker automatically continues its programme. We recommend that the food items be turned. In this way a more uniform thawing can be achieved.

## Jet defrost

1. Press the button (12) „Jet defrost“. The red symbols for the thawing function , Auto Cook  and „M1“ appear in the LED display.
2. Turn the control knob (5), to programme the thawing time. The maximum possible thawing time is 95 minutes.
3. Press the button (16) „Start/Quickstart“ to commence the thawing process. The calculated time is counted down.

## Query functions

### Query the microwave power level during operation.



During the cooking process press the button (18) „Microwave“. The activated power level appears in the LED display for 3 seconds.

### Child protection system



Engage this setting to prevent accidental activation by children and other persons not familiar with the operation of the appliance.

The symbol for the child protection system  appears on the LED display, and the appliance cannot be put into operation for as long as this function is active.

#### Setting the child protection system

Hold the button  „Cancel/Stop/Childlock“ down for ca. 3 seconds. At first an acoustic signal sounds, then the symbol for child protection system  appears in the LED display.

#### Deactivating the child protection system

Hold the button  „Cancel/Stop/Childlock“ down again for ca. 3 seconds, until an acoustic signal sounds and the symbol child protection system  disappears.

#### Power-save function

You can activate the power-save function if you do not wish to use the microwave.

#### Activating the power-save function

Press (in Standby Operation) the button  „Pre-setting“ for one second. The LED display goes out and the power-save function is activated.

#### Deactivating the power-save function

As soon as you press any button, the microwave switches into standby mode. The clock is displayed.

 **Note:** Despite the Power-Save function the clock continues to run in the background.

#### Acoustic signal function

When a cooking process is completed, five short acoustic signals are sounded and "End" and "Hot" appear alternatively in the display. If the door is not opened after ca. 2 minutes, 4 short acoustic signals sound again.

 **Note:**

- If you have pressed a button and activated a valid function, an acoustic signal sounds. If you have selected an invalid button/function, 2 acoustic signals will sound.
- If, after programming the cooking process, you have not pressed the button  „Start/Quickstart“ within 15 seconds, the appliance returns to standby operation (the time is displayed) and an acoustic signal sounds.

KH 1166

## Cleaning and care

**⚠ Warning:** Before cleaning, switch the microwave off and remove the power plug from the wall socket.

- Always keep the interior of the microwave clean.
- If splashes of food or spilt liquids stick to the walls of the microwave, wipe them off with a damp cloth.
- Use a mild detergent if the microwave is more heavily soiled.
- Avoid using cleaning sprays and other aggressive cleaning agents, as they can cause stains, stripes or a blurring of the door surface.
- Clean the external sides with a damp cloth.
- To avoid damage to the functional components in the interior of the microwave, do not let any water seep in through the ventilation slits.
- Regularly remove splashes or contaminants. Clean the door, both sides of the viewing window, door seals and adjacent components with a damp cloth. Do not use abrasive cleaning agents
- If steam should collect on or around the outside of the appliance door, wipe it off with a soft cloth. This can happen if the microwave is operated in extremely humid conditions.
- Regularly clean the turnable grill plate. Wash the turnable grill plate in a warm detergent solution or in the dishwasher. Ensure that, after removing the turnable grill plate from the floor of the cooking space for cleaning, it is correctly reinstalled.
- Regularly clean also the roller wheels and the appliance door to help prevent excessive noise development. Simply wipe the bottom of the microwave with a mild detergent.
- Regularly eliminate odours. Put a deep microwave bowl with a cup of water, juice and peel of a lemon into the microwave. Heat for 5 minutes. Wipe off thoroughly and rub dry with a cloth.
- Should an exchange of the lamp in the microwave become necessary, please arrange for this to be replaced by a dealer or address our Service Department (see Warranty Card).



---

## Disposal

---



**Do not dispose of the device in your normal domestic waste.**

Your local communal or municipal authorities will provide information on how to dispose of the worn out appliance. Observe the currently applicable regulations.

The packaging consists solely of environmentally friendly materials. They can be disposed of in the local recycling containers.

---

## Warranty & service

---

The warranty conditions and the service address are contained in the guarantee booklet.

---

## Importer

---

KOMPERNASS GMBH  
BURGSTRASSE 21  
D-44867 BOCHUM

[www.kompernass.com](http://www.kompernass.com)

---

## Tips

---

### Freezing and thawing – the easy way ...

A microwave oven is the ideal appliance for even and quick thawing of deep-frozen goods. The selection of power, thawing and standing times depends on the nature and amount of food.

Microwaves always penetrate food from the outside to the inside. Therefore, particularly large items cannot be thawed right to the middle, as otherwise the outer layers may begin to cook.

Correct thawing begins with the freezing process. Give the matter some consideration and, as far as possible, portion the amounts small, flat and suited to your household. Consider also the size of the various bowls or plates with which you will later thaw the deep frozen foods in the microwave oven.

In the following thawing chart, several foods are listed. There, in addition to details over time and amount, you will also find the so-called „Stand-Time“. It serves as a temperature equalisation period, during which the remaining warmth in the thawed layers in the middle is conducted to the still frozen layers. During this stand time, leave the deep-frozen goods in the switched off microwave or outside the appliance. There may be deviations in the stated values. These are caused by the different factors of the foods.

KH 1166

Use the integrated thawing functions. See also the chapters "Weight defrost" and "Jet defrost".

Type of food	Rolls
Weight / quantity	50 g/ 2 pc
Defrosting time	approx. 1 min
Standing time	--
Notes/tips	--

Type of food	Bread
Weight / quantity	500 g
Defrosting time	8 - 10 Min.
Standing time	10 - 20 Min.
Notes/tips	--

Type of food	Layer cake
Weight / quantity	400 - 800 g
Defrosting time	8 - 12 Min.
Standing time	90 - 120 Min.
Notes/tips	only slightly defrost the fancy cake

Type of food	Butter
Weight / quantity	250 g
Defrosting time	approx. 1 min
Standing time	20 - 30 Min.
Notes/tips	remove the packaging and lay the Butter on a plate

Type of food	Cheese (piece)
Weight / quantity	500 g
Defrosting time	5 - 6 Min.
Standing time	60 - 90 Min.
Notes/tips	turn it over after half the time has elapsed

Type of food	Cold meats
Weight / quantity	200 g
Defrosting time	approx. 3 min
Standing time	10 - 15 Min.
Notes/tips	turn the slices after half the time has elapsed, carefully separate the slices with a knife before the standing time.

Type of food	Strawberries
Weight / quantity	250 g
Defrosting time	approx. 8 min
Standing time	5 - 10 Min.
Notes/tips	thaw the strawberries or other fruit in a covered bowl. After half the time has elapsed, carefully stir them once.

#### Preparation instructions are important

- Please observe the various preparation instructions absolutely. Whilst the addition of liquid is required (usually 1-2 tblsp. per 100g vegetables) for some foods, no liquid is required e.g. for cucumbers, Spanish onions, mushrooms and spinach. Other foods must be stirred at least once during cooking.

#### Observe stand times

- The so-called "stand time" is particularly important, as it is in thawing. The temperature equalisation and the resulting after-cooking should always amount to 5 - 10 minutes.
- During this stand time, leave the food in the switched off microwave or outside the appliance.
- After this stand time you can season vegetables or add a little butter if desired.
- When cooking food in bowls or deep-frozen convenience foods, pay attention to the preparation times for cooking in microwave ovens stated on the packaging.
- The details in the following chart are intended as reference values only.

To thaw meat, poultry and fish please read the chapter "Thawing by weight".

#### Cooking – the easy way ...

- When cooking food, always use cookware with a lid suitable for microwave cookery (unless stated otherwise).  
The cooking details refer to food at refrigerator temperature. First of all, thaw foodstuffs that are to be cooked.
- i Note:** The thawing time for deep-frozen vegetables (-18°C, approx. 100-1000 g) can vary between 5 and 15 minutes. If in doubt, follow the instructions on the packet. Prepare vegetables by washing and cleaning them before cooking.

KH 1166

Type of food	Boiled potatoes
Weight / quantity	250 g
Add liquid	3 Tbls water
Watts/power	600 Watt
cooking time in mins.	approx. 5 min
Preparation information	in equally sized pieces - drain off the water directly after the cooking time.

Type of food	Noodles
Weight / quantity	125 g
Add liquid	600 ml water
Watts/power	500 Watt
cooking time in mins.	approx. 5 min
Preparation information	first boil-up the water at 800 W (ca. 7 Min). Put in the noodles and cook without a lid.

Type of food	Rice
Weight / quantity	100 g
Add liquid	300 ml water
Watts/power	600 Watt
cooking time in mins.	approx. 3 - 4 min
Preparation information	The maceration time is dependant on the type of rice. Natural rice needs longer.

Type of food	Cauliflower
Weight / quantity	400 g
Add liquid	4 Tbls water
Watts/power	600 Watt
cooking time in mins.	approx. 6 - 7 min
Preparation information	These values are also valid for broccoli.

Type of food	Peas
Weight / quantity	300 g
Add liquid	3 Tbls water
Watts/power	600 Watt
cooking time in mins.	approx. 3 - 4 min
Preparation information	--

Type of food	Spinach
Weight / quantity	500 g
Add liquid	--
Watts/power	600 Watt
cooking time in mins.	approx. 6 min
Preparation information	pour a small amount of cream on the spinach

Type of food	Mushrooms
Weight / quantity	400 g
Add liquid	- -
Watts/power	600 Watt
cooking time in mins.	approx. 5 - 6 min
Preparation information	add a little butter before cooking.

Type of food	Fish fillet
Weight / quantity	400 - 600 g
Add liquid	see notes
Watts/power	500 Watt
cooking time in mins.	approx. 8 - 12 min
Preparation information	add 1 tablespoon of water, lemon, stock or wine per 100 gr of fish.

### Grilling – the easy way ...

- Use the metal rack for all grill processes using top heat ⑨. Always place the turnable grill plate ① under the metal rack ⑨. In this way roasting juices/fats, stocks and soiling by food splashes are captured.
- The grill function is suitable, for example, for thin slices of meat, fish, meatballs, shish-kebab, sausage or pieces of chicken. Toast or rolls can be toasted with the grill (read also "Tips") and gratinated toast (e.g. Hawaii-Toast) can be made.
- You can directly select the grill function or select several foods via the quick-selection buttons with the menu images.
- For some foods, and/or the means of their preparation, a combined cooking and grilling process is advisable. For both possible functions, cooking and grilling times are automatically carried out in the corresponding length. Please also read chapter "Grill/Combi cooking process".
- Prepare the food you wish to grill just as you would usually do. For example, remove the scales from fish first, then gut them. Rub chicken with seasoning and always cook chicken legs skin side first.
- Turn the food after the first stated cooking time. The stated value 1 corresponds with the time for the first side, value 2 for the second, following side.

**ⓘ Note:** Make sure to enter the times for the first and second side separately.

KH 1166

There may be deviations in the following stated values. They result from various factors (such as e.g. temperature, shape) of the food.

Type of food	2 turkey steaks 400 g
Function	Grill (Top / bottom heat)
Time (1st side) in mins.	approx. 12 min
Function	Grill (Top / bottom heat)
Time (2nd side) in mins.	approx. 10 min

Type of food	2 chicken legs 500 g
Function	Grill (Top / bottom heat)
Time (1st side) in mins.	approx. 8 min
Function	Grill (Top / bottom heat)
Time (2nd side) in mins.	approx. 7 min

Type of food	2 Schaschliks 400 g
Function	Grill (Top / bottom heat)
Time (1st side) in mins.	approx. 12 min
Function	Grill (Top / bottom heat)
Time (2nd side) in mins.	approx. 12 min

Type of food	2 trout 400 g
Function	Grill/Combi 2
Time (1st side) in mins.	approx. 8 min
Function	Grill (Top heat)
Time (2nd side) in mins.	approx. 7 min

Type of food	4 Meatballs 600 g
Function	Grill/Combi 2
Time (1st side) in mins.	approx. 12 min
Function	Grill (Top / bottom heat)
Time (2nd side) in mins.	approx. 8 min

Type of food	2 pork chops 600 g
Function	Grill (Top / bottom heat)
Time (1st side) in mins.	approx. 15 min
Function	Grill (Top / bottom heat)
Time (2nd side) in mins.	approx. 13 min

### Suitable tableware

For thawing, cooking etc., always use dishes or bowls suitable for microwave cookery. In most cases suitable glass dishes are acceptable. Procure microwave cookware in various sizes with lids.

### Baking crispy rolls

By means of the grill function of your microwave, you can bake crisp rolls. Before baking, moisten the rolls with a little water. Bake the rolls for approx. 2 minutes, depending on the amount and type. So that the rolls have that 'fresh-from-the-oven' taste on the inside, we recommend that you cut the rolls after the first period and re-bake for one minute, the turn and bake for a further minute.

### Recipe suggestions

#### Pizza

##### Ingredients:

300 g ready-made dough  
200 g strained tomato pulp  
150 g Topping  
(as desired, e.g. ham, salami, mushrooms)  
50 g grated cheese  
Spices: basil, oregano, thyme, salt, pepper

##### Preparation:

Prepare the dough as per the instructions on the packing. Roll out the dough to the size of the grill Revolving Plate. Lightly grease the Grill revolving Plate and lay the dough upon it. Pierce a few holes in the dough. Spread the tomatoes with the seasonings over the pizza base. Place the desired ingredients over it. To finish, sprinkle the Pizza with Cheese. Place the Grill Revolving Plate with the Pizza in the microwave oven and bake it with the programme „fresh Pizza“ (P-3).

KH 1166

### **Onionsoup with baked-over Cheese topping.**

#### **Ingredients for 4 portions.**

300 g onions  
30 g butter, salt, white pepper,  
500 ml instant meat broth  
125 ml white wine, dry  
2 slices of toasted bread  
2 slices of young Gouda cheese

#### **Preparation:**

Peel the onions and cut them into rings. Put them into a microwave dish with the butter and pepper, add the meat broth and cook with lid at 800 watts for approx. 12-15 minutes. Then add white wine and season to taste. Now cut the toasted bread into small cubes. Divide the Onion Soup into 4 soup bowls and spread the bread cubes on the top. Place 1/2 slice of cheese on each soup dish. Place the 4 soup bowls on the Grill Revolving Plate bake the soup with the grill Function „top heat“ for ca. 10 minutes. If possible, use the metal rack ⑨.

### **Lentil Hotpot**

#### **Ingredients:**

200 g dried lentils  
50 g streaky bacon  
125 g belly-pork  
1 bunch vegetable mix for soups  
500 ml water  
1 bayleaf  
250 g potatoes  
2 smoked boiling sausages  
Spices: salt, pepper, vinegar, sugar

#### **Preparation:**

Soak the lentils in plenty of water over night. Clean and wash the soup vegetables and cut them into small pieces. Cube the meat and the bacon. Put the drained lentils into a microwave dish together with 500 ml water and the meat, bacon, soup vegetables and the bayleaf. Cook at 600 watts for 10-12 minutes with the lid on. Peel, wash and cube the potatoes and cut the boiling sausage into slices. Add the pieces of potato and slices of sausage to the hotpot and mix well. Cook at 500 watts for approx. 18 minutes with the lid on. Then season to taste.



### Cauliflower with gratinated cheese topping

**Ingredients:**

500 g cleaned cauliflower  
 250 ml water  
 Salt  
 1 tbsp. starch  
 2 egg whites  
 2 egg yolks  
 1 carton of cream (200 ml)  
 2 tbsp.chives,  
 1 pinch of cayenne pepper  
 150 g raw bacon (lean)  
 50 g grated Emmentaler cheese

**Preparation:**

Split the cauliflower into small sprigs and place them in a microwave dish with 250 ml water and salt. Cook with the lid on at full power 800 Watt for approx. 5 minutes.  
 Drain off the vegetable water and save it. Now stir the cream into the starch and add it to the vegetable water. Cook at full power 800 watts for approx. 2 to 3 minutes, stirring several times. Add the egg yolk, chives and cayenne pepper, beat the egg white and fold it gently into the mixture  
 Place the cauliflower and the bacon (in strips) into a flat casserole dish, then pour over the sauce and cover with grated cheese. Cook and bake over with the Grill/Kombi 1 at 500 Watt for 18-22 minutes. If possible, use the metal rack ⑨.

### Macaroni and minced meat cassero- le with broccoli

**Ingredients:**

150 g macaroni, 500 ml water  
 1 tsp. salt, 1 onion, 1 clove of garlic  
 20 g butter, 300 g mixed mincemeat (half pork, half beef)  
 1 Packet tomato puree with herbs (350 g)  
 400 g broccoli, 4 tbsp. water  
 1 carton sour cream (200 g)  
 150 g sliced Gouda cheese semi-mature  
 Spices: salt, pepper

**Preparation:**

Put 500 ml of water with 1 teaspoon of salt in bowl suitable for microwaving, with a lid, and bring it to the boil with the full power of 800 Watt in ca. 10 minutes. Then add macaroni and cook for 3-5 minutes at 600 watts and then at 300 watts for another 3-5 minutes. Then pour it into a sieve and allow it to drip dry. Now braise the onion and the clove of garlic with the butter in a microwave dish at 600 watts for approx. 4-5 minutes. Add the mincemeat and tomato purée – cook again for 8-10 minutes at 600 watts. Stir in 3/4 carton of sour cream and season with salt and pepper. Wash and clean the broccoli and place it into a microwave dish with 4 tblsp. water. Pre-cook with lid at 800 watts for aprox. 5 minutes, then allow to drain off. Put the macaroni, vegetables and mincemeat sauce into a casserole dish and mix. Divide the remaining 1/4 of sour cream over the top and cover everything with the cheese slices. With the setting of Grill/Combi 1 cook and bake-over at 500 Watts for ca. 16-18 minutes. If possible, use the metal rack ⑨.

KH 1166

### Fillet of pork with mushrooms in spicy paprika sauce

#### Ingredients:

4 fillets of pork, each approx. 150 g  
350 g white mushrooms  
150 g cubed bacon  
2 cartons of cream (400 ml)  
2 tblsp. tomato purée  
Spices: salt, pepper, paprika

#### Preparation:

Season the fillets of pork and place them in a flat casserole dish. Clean and halve the mushrooms and put them into the casserole dish with the fillets of pork. Mix the cream, concentrate of tomato and capsicum in a microwave-safe dish and cook at 600 watts for approx. 5-6 minutes to bring to boil. Then pour the sauce over the fillets. With the setting of Grill/Combi 2 cook and bake-over at 300 Watts for ca. 20-22 minutes

### Potato gratin

#### Ingredients:

1000 g potatoes  
Fat (to grease the casserole dish)  
2 tblsp. breadcrumbs  
1 carton of cream (200 ml)  
50 g grated Emmentaler cheese  
Butter (flakes)  
Spices: salt, pepper

#### Preparation:

After washing and peeling, cut the potatoes into thin slices and season them. Grease a casserole dish, layer the potatoes and pour the cream over them. Finally, sprinkle with the cheese and breadcrumbs and distribute the butter flakes over the top. With the setting of Grill/Combi 1 gratinate at 500 Watts for ca. 20 minutes. If possible, use the metal rack ④.

### Chicken Fricassee

**Ingredients:**

1 chicken (approx. 1000 g)  
300 g mushrooms  
500 g asparagus  
250 ml instant meat broth  
100 ml cream  
2 packets white sauce (instant)  
1 tblsp. white wine  
Spices: salt, pepper, nutmeg

**Preparation:**

Bestrew the chicken with salt and place it in a bowl with lid suitable for microwaving.

Then cook it for ca. 16 - 18 minutes at 800 Watts.

Clean and halve the mushrooms, peel the asparagus and cut it into 2 to 3 cm long pieces. Remove the skin and bones from the cooked chicken and cut the meat into bite-size pieces.

Put the meat broth, chicken, asparagus and mushrooms into a microwave dish. Cook with the lid on at 600 watts for approx. 13-15 minutes, stirring occasionally. Stir in the cream and white sauce powder and cook at 600 watts for another 5-6 minutes. Season to taste with white wine, salt, pepper and nutmeg.

### Green chicken casserole

**Ingredients:**

400 g chicken breast fillet  
1 small courgette  
1 small green paprika  
125 ml instant chicken broth  
200 g leeks  
150 g turnip cabbage  
150 g celery  
2 tblsp. crème fraîche  
50 g cream cheese with herbs

**Preparation:**

Clean and wash the vegetables. Cut the leeks into rings and the turnip cabbage and celery into thin slices. Braise in a microwave dish with lid at 600 watts for approx. 6-8 minutes. Cut the chicken breast into small pieces, the courgette into half slices and the paprika into cubes, and put them into the dish together with the hot instant chicken broth and the other ingredients. Cook with lid at 600 watts for approx. 12-15 minutes, stirring occasionally. Then stir in the crème fraîche and the cream cheese with herbs.

KH 1166

### Bread or bacon dumplings

#### Ingredients for 4 dumplings

4 wheat rolls  
1/2 tsp. salt  
150 ml milk  
40 g butter  
3 eggs  
2 -3 tblsp. breadcrumbs  
2-3 tblsp. chopped parsley  
30 g cubed bacon (for bacon dumplings)

#### Preparation:

Cut the rolls small and sprinkle with salt. Heat the milk in a microwave dish (at 800 watts for approx. 2-4 minutes), then pour it over the rolls and leave to stand for approx. 15 minutes. Beat the Butter and eggs into a creamy mass, blend in the softened bread-rolls together with the breadcrumbs and chopped parsley and knead everything into a good dough (Tip: for bacon dumplings, also knead in the cubed bacon). Moisten your hands and shape 4 equally sized dumplings, which are then dipped into cold water for a short time. Cook at 500 watts under a lid for approx. 6-8 minutes, they are then ready to be served.

### White sauce

#### Ingredients:

40 g flour  
30 g butter  
250 ml instant broth  
250 ml milk  
Spices: salt, white pepper, sugar

#### Preparation:

Put the flour, butter, hot broth and milk into a microwave dish, mix well and cook at full power, 800 watts for approx. 4-5 minutes, stirring well occasionally. Then cook further for another 4-5 minutes at just 300 watts. Mix well again and add the seasonings to taste.

### Vanilla sauce

#### Ingredients:

250 ml milk  
Pulp of 1/2 a vanilla bean  
1 carton of cream (250 ml)  
2 tblsp. starch  
3 tblsp. sugar  
1 egg yolk

#### Preparation:

Mix the milk, vanilla paste, cream, corn flour and sugar in a microwave-safe bowl. Heat for approx. 4-5 minutes at 800 Watts to bring to boil, stirring occasionally. Stir the cooked sauce well and bind it with egg yolk.

### Rice pudding

#### Ingredients:

250 g rice for milk puddings  
1 l. milk  
1 tsp. butter  
40 g sugar, cinnamon and sugar  
(for sprinkling) or stewed fruit  
Seasoning: Salt

#### Preparation:

Put the rice, milk, a pinch of salt, butter and sugar into a large microwave basin. Cook under a lid at full power of 800 Watt for ca. 10-12 minutes, then stir and with only 100 Watt allow to swell for ca. 20-22. Afterwards, allow it to stand, stir it well once more and then garnish with cinnamon and sugar or fruit sauce, dependant on preference.

### Red fruit pudding (with strawberries and raspberries)

#### Ingredients:

250 g deep frozen Strawberries  
250 g deep frozen Raspberries  
1 packet of vanilla sugar  
2 tbsp. sugar  
2 tbsp. starch

#### Preparation:

First stir the starch into 3 tbsp. of water. Place the fruit in a microwave suitable dish with a lid. Subsequently, with full power of 800 Watt, thaw and heat in ca. 6-8 minutes. Lightly squash the fruits and add vanilla sugar, sugar and starch. Mix well and cook with the lid on for approx. 6-8 minutes at 600 watts. Finally pour the pudding into dessert bowls and allow to cool.  
① Serve the compote with the Vanilla Sauce described above. ...

### Enjoy your meal!

Recipes provided without guarantee. All ingredients and preparation information are guiding values. Add your own personal experience to these recipes. We hope you enjoy the recipes and wish you "bon appetit".

KH 1166

---

## Index

---

Auto Menu 16  
Auto warming 17  
Beef 16-17, 31  
Beverages 9, 16-18  
Bread 24, 30, 34  
Butter 24-25, 27, 30-32, 34-35  
Cauliflower 26, 31  
Cheese 24, 29-33  
chicken 11, 18, 27-28, 33  
Child protection system 20-21  
Cleaning 6, 22, 25  
Cookware 11-12, 25, 29  
Disposal 23  
Earthing notice 10  
Entrees 17  
Fish 17, 20, 25, 27  
Grill function 3, 5, 15, 18-19, 27, 29-30  
Jet defrost 5, 20, 24  
Layer cake 24  
Meatballs 11, 27-28  
Memory function 15  
Mushrooms 25, 27, 29, 32-33  
Noodles 26  
Peas 26  
Pizza 17-18, 29  
Pork 16-17, 28, 30-32  
Potato gratin 32  
Potatoes 9, 17, 26, 30, 32  
Poultry 16-17, 20, 25  
Power-save function 21  
Pre-setting 5, 15  
Quick start 14  
Red fruit pudding 35  
Rice 26, 35  
Rice pudding 35  
Rolls 18, 24, 27, 29, 34  
Sausage 16-17, 20, 27, 30  
Schaschliks 28  
Select power 14  
Service 9, 22-23  
Setting the clock 12  
Spinach 25-26  
Strawberries 25, 35  
turkey 28  
Turnable grill plate 5, 13, 18, 22, 27  
Vegetables/fruit 17-18  
Warranty 5, 22-23  
Weight defrost 5, 20, 24

*KH 1166*

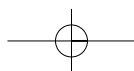
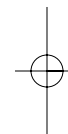
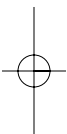

## Free Manuals Download Website

<http://myh66.com>

<http://usermanuals.us>

<http://www.somanuals.com>

<http://www.4manuals.cc>

<http://www.manual-lib.com>

<http://www.404manual.com>

<http://www.luxmanual.com>

<http://aubethermostatmanual.com>

Golf course search by state

<http://golfingnear.com>

Email search by domain

<http://emailbydomain.com>

Auto manuals search

<http://auto.somanuals.com>

TV manuals search

<http://tv.somanuals.com>