

GB

Mini Hi-Fi System with Subwoofer KH 2265

IRL

Instructions for use



Kompernaß Handelsgesellschaft mbH, Burgstraße 21, D-44867 Bochum, Deutschland/Germany
www.kompernass.com

KH 2265	v.1.0
En	10-09-2004

1. Index

2. Safety instructions	5
3. Usage	6
4. Scope of delivery	6
5. Technical data	6
5.1. Main unit.....	6
5.1.1. CD player.....	6
5.1.2. Frequency ranges.....	6
5.2. Subwoofer.....	6
5.3. Dimensions (L × W × H).....	6
5.4. Weight.....	6
6. Components, operating controls and displays of the mini hi-fi system	7
6.1. Main unit, top.....	7
6.2. Main unit, front.....	7
6.2.1. Display indicators.....	7
6.3. Main unit, back.....	8
6.4. Subwoofer, back.....	8
6.5. Subwoofer, front.....	8
6.6. Remote control unit.....	8
7. Select a suitable location for the mini hi-fi system	9
8. Preparing the mini hi-fi system for use	9
8.1. Unpacking the components.....	9
8.2. Preparing the remote control unit for use.....	9
8.3. Connect the subwoofer to the main unit.....	9
8.4. Connect the loudspeakers to the main unit.....	9
9. Turning the mini hi-fi system on and off	10
10. Using the mini hi-fi system radio	10
10.1. Using the automatic radio station search.....	10
10.2. Manually searching for a radio station.....	10
10.3. Improving reception quality of frequency modulation (FM) radio stations.....	10
10.4. Programming a radio station.....	11
10.5. Selecting a preset radio station.....	11
11. Using the mini hi-fi system CD player	11
11.1. Playing audio CDs and MP3 CDs.....	11
11.2. Skipping to the beginning of a song.....	12
11.3. Using the fast-forward and rewind functions.....	12
11.4. Switching to another folder (only for MP3 CDs).....	12
11.5. Using the intro function.....	12
11.6. Turning on the repeat functions.....	12
11.7. Turning on the random play function.....	13
11.8. Using the program function.....	13
11.9. Displaying additional information (only for MP3 CDs).....	13

11.10. Search functions (only for MP3 CDs)	14
11.10.1. Search for file names	14
11.10.2. Searching for folder names	14
12. General functions for radio and CD operation	14
12.1. Adjusting the volume	14
12.2. Muting the loudspeakers	14
12.3. Turning on the Equalizer function	14
12.4. Adjusting the subwoofer.....	15
13. Additional functions of the mini hi-fi system.....	15
13.1. Adjusting the clock of the mini hi-fi system	15
13.2. Using the timer function	15
13.3. Using the sleep timer function	16
14. Connecting headphones to the mini hi-fi system	16
15. Connecting external audio devices to the mini hi-fi system	16
16. Cleaning the mini hi-fi system	16
17. Troubleshooting	17
17.1. Nothing appears on the display screen. The mini hi-fi system is not functioning even though it has been turned on.	17
17.2. "No Disc" appears on the display screen even though a CD has been inserted.	17
17.3. The inserted CD is not played	17
17.4. There is no sound	17
17.5. The remote control unit is not working.....	18
17.6. Other malfunctions.....	18
18. Disposing of the mini hi-fi system	18

2. Safety instructions

Danger!

Do not place the mini hi-fi system ...

- in areas exposed to direct sunlight. Otherwise, the mini hi-fi system could overheat and be damaged irreparably. This could cause a fire!
- in the immediate vicinity of heat sources such as ovens, heaters and similar devices or vent openings of other electrical devices. Otherwise, the mini hi-fi system could be damaged irreparably. This could cause a fire!
- in dusty environments. Otherwise dust could collect in the mini hi-fi system. If a large quantity of dust collects in the mini hi-fi system, it could overheat and be damaged irreparably. This could cause a fire!
- in damp environments. Otherwise moisture could seep into the mini hi-fi system. This could cause danger of electrical shock and fire!
- in the immediate vicinity of water, such as bath tubs or swimming pools. Do not place any receptacles containing water (e.g. flower vases) on the mini hi-fi system. If water enters the mini hi-fi system or it falls into water, it could cause danger of electrical shock!

Do not place open flames (e.g. burning candles) on the mini hi-fi system. This could cause a fire!

Do not cover the vent openings of the mini hi-fi system! Do not place the mini hi-fi system on beds, blankets, etc. Make sure that the vent openings are at least 10 cm from the nearest wall or large object. Otherwise, the mini hi-fi system could overheat and be damaged irreparably! This could cause a fire!

In the case of malfunction, never attempt to repair the power supply cable yourself! This could cause danger of electric shock!

Warning!

The mini hi-fi system and its components contain no user-serviceable parts. The warranty is voided if the casing of the mini hi-fi system, remote control unit and/or the loudspeakers is opened! For repairs, please contact your nearest service partner. The addresses of our service partners are found in the warranty booklet delivered with the wine bottle opener.

Battery acid could leak out, especially if the batteries are old. Therefore you should remove all batteries if you do not use the mini hi-fi system and remote control for long periods of time. This can protect the mini hi-fi systems and remote control unit from damages resulting from leaked battery acid.

Careful!

Do not place the mini hi-fi system in areas exposed to physical shock or constant vibrations. Physical shock and constant vibrations could lead to malfunctions and long-term damage.

Note:

No liability will be taken and no guarantee will be made for damages ...

- resulting from opening the casing of the mini hi-fi system, remote control and/or loudspeakers,
- resulting from repair attempts not made by qualified experts,
- resulting from other than intended usage of mini hi-fi system or its components!

The mini hi-fi system will become warm when turned on. This is not a cause for concern and does not indicate a technical problem.

3. Usage

The mini hi-fi system is exclusively intended for use ...

- as an entertainment device
- as a receiver for medium wave (AM) and frequency modulation (FM) radio stations.
- as a playback device for ...
 - audio CDs of 12 cm (diameter) and 8 cm (diameter) formats, indicated by the logo 
 - the CD audio file format (.cda) on CD-R and CD-RW storage medium
 - the .mp3 file format on CD-R and CD-RW storage medium
- stationary in closed spaces
- for private and not for commercial use.

Note:

No liability will be assumed and no warranty granted for damages caused by use of the mini hi-fi system other than intended.

4. Scope of delivery

- ✓ Main unit
- ✓ Subwoofer
- ✓ Two loudspeakers
- ✓ Remote control unit
- ✓ These instructions for use

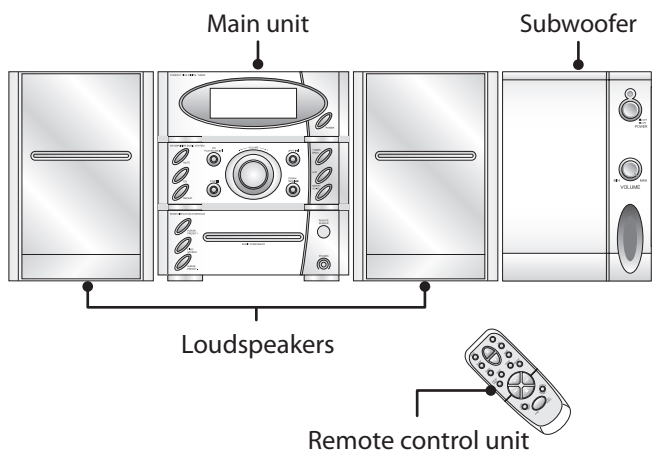

5. Technical data

5.1. Main unit

Mains connection
(via Subwoofer):..... 230 V AC ~50Hz
Output/channel:..... 5 Watt to 4 Ohm

5.1.1. CD player

Laser:..... 3-beam laser pickup
Frequency response (-6 dB):.. 20 – 15,000 Hz
Signal-to-noise ratio:..... 50 dB
Harmonic distortion: 0.4 %
Channel separation: 40 dB

5.1.2. Frequency ranges

Medium wave (AM): 522 – 1620 kHz
Frequency modulation (FM): 87.5 – 108 MHz

5.2. Subwoofer

Power supply: 230 V AC ~ 50 Hz
Output:..... 15 Watt to 4 Ohm
Power consumption: 85 Watts

5.3. Dimensions (L x W x H)

Main unit: 205 x 140 x 143 mm
Loudspeakers: 208 x 140 x 143 mm
Subwoofer:..... 235 x 146 x 143 mm

5.4. Weight

Main unit: 1,365 g
Loudspeakers (each): 1,140 g
Subwoofer:..... 3,282 g

6. Components, operating controls and displays of the mini hi-fi system

6.1. Main unit, top

- ❶ CD compartment
- ❷ Open/Close button

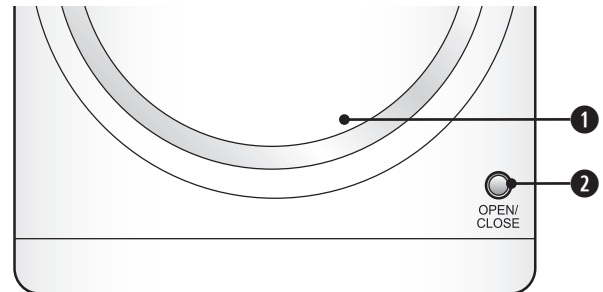

6.2. Main unit, front

- ❸ Display
- ❹ Power button
- ❺ Tuner/Band button
- ❻ AUX button
- ❼ Memory/CLK-Adj button
- ❽ Infrared receiver for remote control unit
- ❾ Headphones jack
- ❿ Up/FF button
- ⓫ Down/REW button
- ⓬ Volume control
- ⓭ Stop button
- ⓮ CD / Play/Pause button
- ⓯ Album/Preset- button
- ⓰ Find/Stereo
- ⓱ Album/Preset+ button
- ⓲ Repeat button
- ⓳ EQ button
- ⓴ Mute button

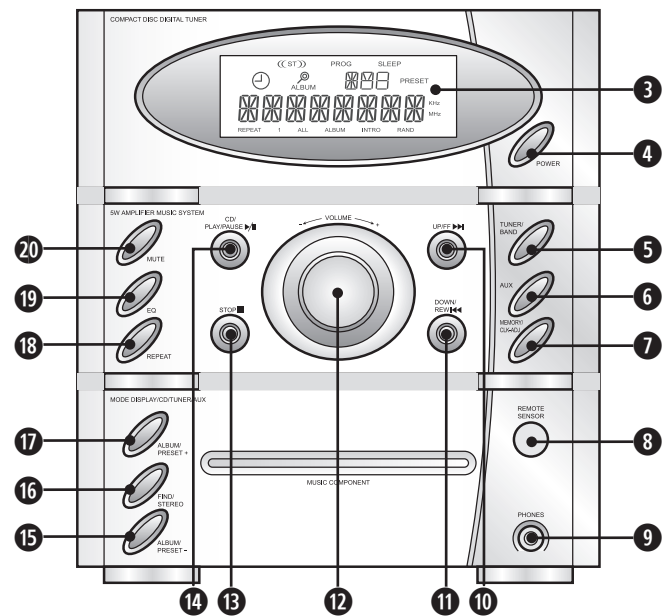

6.2.1. Display indicators

- ❶ **During radio operation:** Display for stereo reception for FM radio stations
- ❷ **During CD operation:** Magnifying glass symbol for search functions
- ❸ **During radio operation:** Display for preset number of the current radio station
- ❹ **During CD operation (only for MP3 CDs):** Display for the current folder number
- ❺ **During radio operation:** Display for frequency of the current radio station
- ❻ **During CD operation:** Display for the time that the current song has been playing
- ❼ **During CD operation:** Display for the number of the current song
- ❽ **During radio operation:** Display for frequency range of the current radio station
- ❾ Clock symbol if the timer function has been switched on

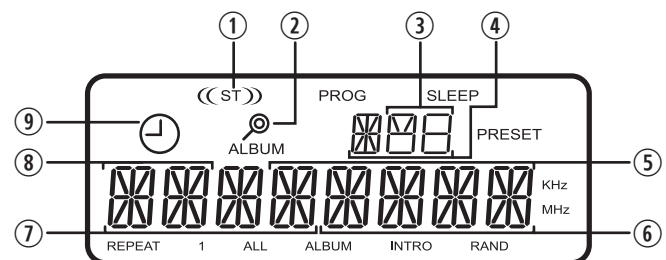

6.3. Main unit, back

- 21 Subwoofer connector cable
- 22 Loudspeaker outputs
- 23 Trajectory antenna
- 24 AUX inputs for cinch cable

6.4. Subwoofer, back

- 25 Subwoofer connector cable input
- 26 Main On/Off switch
- 27 Power cable

6.5. Subwoofer, front

- 28 Volume control
- 29 Power button
- 30 Subwoofer on/off indicator

Note:

The same buttons on the main unit and the remote control unit have the same functions. However, some of the buttons have different names on the main unit than on the remote control unit. The following overview of the remote control buttons indicates the corresponding buttons on the main unit in parentheses.

6.6. Remote control unit

- 31 Volume button ▲ (increase volume)
- 32 Volume button ▼ (decrease volume)
- 33 Button Ⓞ (corresponds to the Power button on the main unit)
- 34 EQ button
- 35 Band button (corresponds to the Tuner/Band button on the main unit)
- 36 Intro button
- 37 Repeat button
- 38 Button ▶ (corresponds to the CD / Play/Pause button on the main unit)
- 39 Button Ⓢ (corresponds to the Up/FF button on the main unit)
- 40 Album/Preset+ button
- 41 Find / ST/Mono button (corresponds to the Find/Stereo button on the main unit)
- 42 Album/Preset- button
- 43 Button ◻ (corresponds to the Stop button on the main unit)
- 44 Button ◀ (corresponds to the Down/REW button on the main unit)
- 45 Prog/Mem button (corresponds to the Memory/CLK-Adj button on the main unit)
- 46 Rand button
- 47 Timer button
- 48 Sleep button
- 49 Mute button

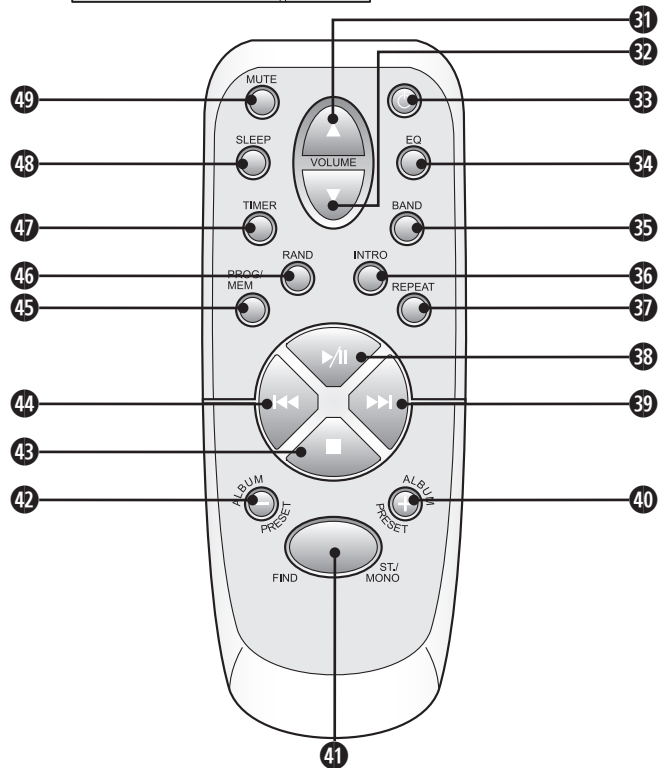
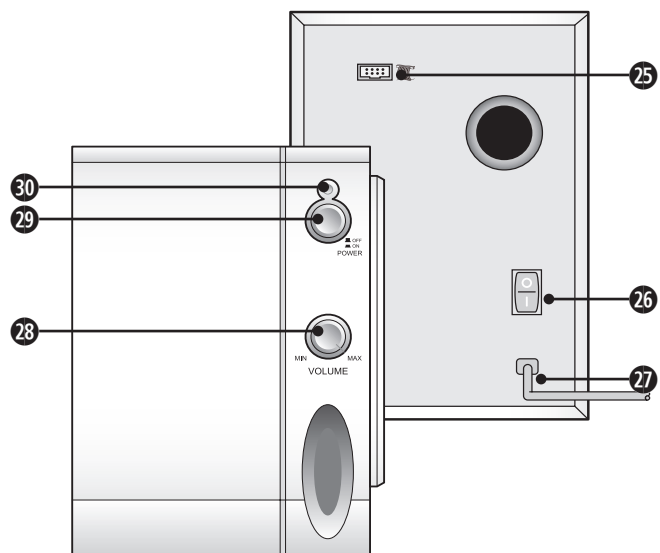
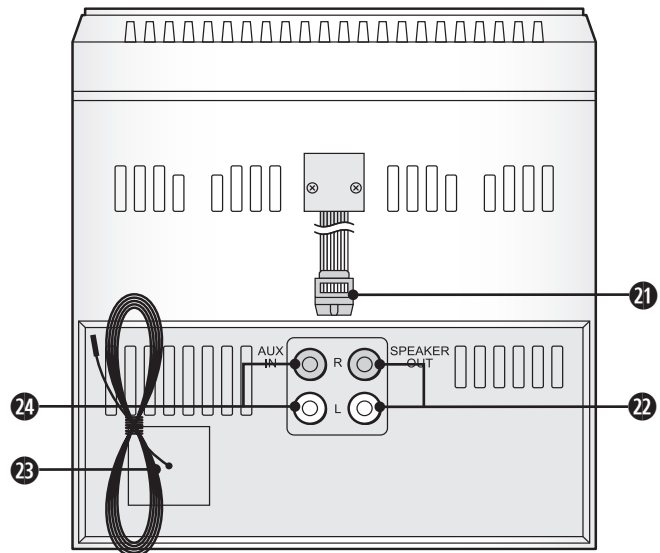

7. Select a suitable location for the mini hi-fi system

Place the mini hi-fi system and loudspeakers on a level, flat, scratchproof, non-slip surface. Make sure that the surface is made to support the weight of the mini hi-fi system/speakers.

Danger!

Do not place the mini hi-fi system ...

- *in areas exposed to direct sunlight. Otherwise, the mini hi-fi system could overheat and be damaged irreparably. This could also cause a fire!*
- *in the immediate vicinity of heat sources such as ovens, heaters and similar devices or vent openings of other electrical devices. Otherwise, the mini hi-fi system could be damaged irreparably. This could cause a fire!*
- *in dusty environments. Otherwise dust could collect in the mini hi-fi system, it could overheat and be damaged irreparably. This could cause a fire!*
- *in damp environments. Otherwise moisture could seep into the mini hi-fi system. This could cause danger of electrical shock and fire!*
- *in the immediate vicinity of water, such as bath tubs or swimming pools. Do not place any receptacles containing water (e.g. flower vases) on the mini hi-fi system. If water enters the mini hi-fi system or it falls into water, it could cause danger of electrical shock!*

Do not place open flames (e.g. burning candles) on the mini hi-fi system. This could cause a fire!

Do not cover the vent openings of the mini hi-fi system! Do not place the mini hi-fi system on beds, blankets, etc. Otherwise, the mini hi-fi system could overheat and be damaged irreparably! This could cause a fire! Make sure that the vent openings are at least 10 cm from the nearest wall or large object.

Careful!

Do not place the mini hi-fi system in areas exposed to physical shock or constant vibrations. Physical shock and constant vibrations could lead to malfunctions and long-term damage.

8. Preparing the mini hi-fi system for use

8.1. Unpacking the components

Carefully remove all components from the packaging. Always hold components with both hands. Do not drop the components! This could cause irreparable damage.

8.2. Preparing the remote control unit for use

- 1 Open the battery compartment of the remote control unit.
- 2 Place two AAA/LR03/Micro batteries in the battery compartment. These are not included in the delivery. Insert the batteries in the right direction (polarity +/-) as shown on the battery compartment.
- 3 Close the battery compartment of the remote control unit.

Warning!

Battery acid could leak out, especially if the batteries are old. Therefore you should remove all batteries if you do not plan to use the remote control unit for long periods of time. This protects the remote control unit from battery acid leakage.

8.3. Connect the subwoofer to the main unit

Insert the subwoofer connector cable into the appropriate input on the back of the subwoofer.

8.4. Connect the loudspeakers to the main unit

- 1 Uncoil the loudspeaker connector cable to its full length.
- 2 The loudspeaker connector cables have to be connected to the loudspeaker outputs on the back of the main unit.

Insert ...

- the right loudspeaker connector cable in the red loudspeaker output "R".
- the left loudspeaker connector cable in the white loudspeaker output "L".

9. Turning the mini hi-fi system on and off

To turn the mini hi-fi system on:

- 1 Insert the power cable plug into an electrical outlet.
- 2 Switch the main switch on the back of the subwoofer to the On position.
- 3 Press the Power button on the front of the subwoofer. The subwoofer on/off indicator lights up. The mini hi-fi system is now in standby mode.
- 4 To turn the mini hi-fi system on: Press the Power button on the main unit. The display screen lights up and "Hello" is displayed.
- 5 To switch the mini hi-fi system back to standby mode: Press the Power button again. "Good Bye" appears in the display screen and then the display turns off.

To turn the mini hi-fi system off:

- 1 Press the Power button on the front of the subwoofer. The subwoofer on/off indicator light goes off.
- 2 Subsequently, switch the main switch on the back of the subwoofer to the Off position.
- 3 If you do not want to use the mini hi-fi system for a long period of time: Unplug the power plug from the electrical outlet.

10. Using the mini hi-fi system radio

- 1 Turn on the mini hi-fi system by pressing the Power button. After "Hello" appears in the display ...
 - the current frequency range (AM medium wave or FM frequency modulation) and
 - the frequency of the currently selected radio station are displayed.
- 2 Switch between the two frequency ranges (AM medium wave and FM frequency modulation) by pressing the Tuner/Band button. The currently selected frequency range is indicated on the display screen. You can select a radio station using one of two options: the automatic station search or the manual search.

10.1. Using the automatic radio station search

- 1 Press and hold for a few seconds ...
 - the Up/FF button to search forwards or
 - the Down/REW button to search backwards.
- 2 The next available radio station will be found automatically. As soon as a radio station is found with a sufficient broadcast signal, the station search will be stopped.
- 3 If you would like to search further for a radio station: Press and hold for a few seconds the Up/FF or Down/REW buttons again. The station search will continue until the next radio station with a sufficient broadcast signal is found.

10.2. Manually searching for a radio station

The manual search can be used to find radio stations, for which only poor reception quality is available. To use this function, repeatedly press the Up/FF or Down/REW button. You can use this function to ...

- search the medium wave (AM) frequency range in steps of 9 kHz.
- search the frequency modulation (FM) frequency range in steps of 0.05 kHz.

Repeat this until you have found the required radio station.

If a stereo radio station is found, then the stereo symbol will appear on the display screen.

10.3. Improving reception quality of frequency modulation (FM) radio stations

To improve reception quality of FM radio stations:

- 1 Slowly move the end of the trajectory antenna connected to the main unit so that it points in different directions. Once you have found a good position for reception of the radio station: Fix the trajectory antenna in this position (e.g. with tape).
- 2 In the case of poor reception of a frequency modulation (FM) radio station in stereo mode, it could also help to switch to mono reception. To do this, press the Find/Stereo button once stereo reception is currently on. "Mono" will appear briefly on the display screen. If you would subsequently like to return to stereo reception, press the Find/Stereo button again. "Stereo" will appear briefly on the display screen and then the stereo symbol will be indicated on the display screen.

10.4. Programming a radio station

You can preset up to ten radio stations in each frequency range. To do this:

- 1 Use the automatic search function or the manual search function to search for the radio station that you would like to preset.
- 2 Once you have found the desired radio station, press the Memory/Clk-Adj button. "Prog" will appear on the display screen and 01 will blink for the first program position.
- 3 Press the Album/Preset+ button or the Album/Preset- button to select another program position. The currently selected program position will blink on the display screen.
- 4 Once the program position number, under which you would like to save the radio station, appears on the display screen: Press the Memory/Clk-Adj button again. The radio station is now preset for the selected program position. The number of the program position, Preset and the radio station frequency are shown on the display screen.
- 5 To preset additional radio stations on other program positions: Repeat steps 1 to 4.

To move a preset radio station to another program position:

- 1 Select the radio station by pressing the Album/Preset+ button or the Album/Preset- button.
- 2 Press the Memory/Clk-Adj button. "Prog" appears on the display screen and the program position number blinks.
- 3 Press the Album/Preset+ button or the Album/Preset- button to select another program position.
- 4 Once the program number, under which you would like to save the radio station, appears on the display screen: Press the Memory/Clk-Adj button again. The radio station is now preset for the selected program position. The number of the program position, Preset and the radio station frequency are shown on the display screen.

Note:

If you preset a radio station to correspond to a program position that is already occupied: Then the radio station that was previously preset for the program position will be deleted.

10.5. Selecting a preset radio station

- 1 Press the Tuner/Band button to select the frequency range of the preset radio station. The selected frequency

range (AM medium wave or FM frequency modulation) will appear on the display screen.

- 2 To switch through the preset radio stations in the selected frequency range: Press the Album/Preset+ button or the Album/Preset- button. The program position of the currently selected radio station appears on the display screen.

11. Using the mini hi-fi system CD player

11.1. Playing audio CDs and MP3 CDs

You can use the CD player of the mini hi-fi system to ...

- play standard audio CDs and
- play CD-Rs and CD-RWs containing MP3 (.mp3) files.

Note:

In the following set of instructions, we will use the common term "CD" to describe both audio CDs and MP3 CD-Rs/CD-RWs. We will indicate steps, which differ for audio CDs and MP3 CD-Rs/CD-RWs, using the notes "for audio CDs" and "for MP3 CDs".

- 1 Turn on the mini hi-fi system by pressing the Power button.
- 2 Press the CD / Play/Pause button to switch to the CD function. "CD" will appear briefly on the display screen.
- 3 "No Disc" will appear on the display screen if no CD is placed in the CD compartment. Press the Open/Close button on the top of the main unit to open the CD compartment.

Note:

The first time you open the CD compartment, remove the cardboard protection card.

- 4 Place a CD on the spindle in the middle of the CD compartment. The labeled side of the CD should be facing up.
- 5 Press the Open/Close button to close the CD compartment.

For audio CDs: The number of songs on the CD and the total duration of the CD appear on the display screen.

For MP3 CDs: The number of MP3 files and the number of folders on the CD appear on the display screen.

- 6 Press the CD / Play/Pause button to start playing the CD.

For audio CDs: The number of the current song and the time that has already been played appear on the display screen.

For MP3 CDs: The number of the folder, in which the current song is found, will also be displayed. If there are no folders on the CD, then the number 1 will be displayed as the folder number.

- 7 To pause playing the CD: Press the CD / Play/Pause button. The time already played of the current song will blink on the display screen.
- 8 To continue playing the CD: Press the CD / Play/Pause button again.
- 9 To stop playing the CD: Press the Stop button.

For audio CDs: The number of songs and the total play time of the CD will appear on the display screen.

For MP3 CDs: The number of MP3 files, the number of folders and "Stop" appear on the display screen.

11.2. Skipping to the beginning of a song

While playing a CD, you can ...

- Press the Up/FF button: to skip to the beginning of the next song or
- Press the Down/REW button: to return to the beginning of the song that is currently being played.

The selected song will be played immediately, without you having to press the CD / Play/Pause button.

11.3. Using the fast-forward and rewind functions

To fast-forward or rewind within the current song in order to select certain parts of the song:

- 1 to fast-forward: hold the Up/FF button while the song is being played.
- 2 to rewind: hold the Down/REW button while the song is being played.
- 3 Release the button as soon as you have found the desired part of the song. The song will start playing at the selected place.

11.4. Switching to another folder (only for MP3 CDs)

As opposed to audio CDs, the songs on an MP3 CD-R/CD-RW can be saved in file folders. This could be used to sort songs ac-

ording to genre (e.g. rock, classical, pop) for example. To switch to a folder other than the one that the current song is in:

- 1 Press the Album/Preset+ button to switch to the next folder number up.
- 2 Press the Album/Preset- button to switch to the next folder number down.

If you press the Album/Preset+ button or the Album/Preset- button while a song is being played: then the first song in the selected folder will be played.

11.5. Using the intro function

You can use the intro function to play the first 10 seconds of every song on a CD. You can use this function to obtain a quick overview of all songs on a CD. To turn on the intro function:

- 1 If a CD is being played, press the Stop button.
- 2 Subsequently press the Intro button on the remote control unit once. "Intro" appears on the display screen. The first ten seconds of each song on the CD will be played one after the other.
- 3 To turn off the intro function: Press the Intro button on the remote control unit again. "Intro" disappears from the display screen and the CD is played. Otherwise, the intro function will shut off automatically after playing the first 10 seconds of the last song.

11.6. Turning on the repeat functions

You can use this function to repeat a certain song or the entire CD. For MP3 CDs, the current folder can also be played repeatedly. To turn on the repeat function:

- 1 Press the Repeat button while a song is being played. "Repeat 1" will appear on the display screen. The song will be played repeatedly.
- 2 Press the Repeat button a second time. "Repeat all" will appear on the display screen. The entire CD will now be played repeatedly.

For MP3 CDs: Press the Repeat button a third time. "Repeat Album" will appear on the display screen. The songs in the current folder will be played repeatedly.

- 3 To turn off the repeat function: Press the Repeat button until Repeat 1/Repeat all/Repeat Album disappears from the display screen. You can also press the Stop button to achieve the same results. However, this not only turns off the repeat function, but also stops playing.

11.7. Turning on the random play function

The random play function can be used to play all songs of a CD in random order. To turn on the random play function:

- 1 If a CD is being played, press the Stop button.
- 2 Subsequently press the Rand button on the remote control unit. All songs on the CD will be played in random order. "Rand" appears on the display screen.
- 3 To turn off the random play function: Press the Rand button on the remote control unit again. "Rand" will disappear from the display screen.

11.8. Using the program function

You can use the program function to determine a sequence of songs on a CD to be played in a certain order. You can determine the order that the songs should be played in. Up to 64 songs can be put together in a single sequence. To program a sequence of songs.

- 1 First stop playing the inserted CD by pressing the Stop button.
- 2 Press the Memory/Clk-Adj button. "Prog", "00" and "P-01" appear on the display screen.

For MP3 CDs: The folder number display blinks as well. Select the folder containing the first song to be programmed. To do this, press the Up/FF or Down/REW button. Press the Memory/Clk-Adj button as soon as the number of the desired folder appears on the display screen. The song number blinks on the display screen.

- 3 Select the song to be programmed first. To do this, press the Up/FF or Down/REW button. The number of the currently selected song appears on the display screen.
- 4 Press the Memory/Clk-Adj button as soon as the number of the desired song appears on the display screen. This song is now programmed as the first song in your sequence. "P-02" appears on the display screen for the second song to be programmed.
- 5 Repeat steps 3 and 4 repeatedly until you have compiled the desired sequence of songs.
- 6 After having programmed the last desired song, press the CD / Play/Pause button. The programmed song sequence will now be played. "Prog" will appear on the display screen while the programmed song sequence is being played.

Note:

You can also turn on the repeat function while playing a song sequence. Turning on the repeat functions is described in chapter 11.6.

- 7 If you want to pause playing the song sequence: Press the CD / Play/Pause button. The time already played of the current song will blink on the display screen.
- 8 If you want to stop playing the song sequence: Press the Stop button.
- 9 After the song sequence has been played, the number of songs and the total duration of the CD will appear on the display screen. The programmed song sequence remains in memory. This also applies if you stop playing by pressing the Stop button. If you would like to listen to the song sequence again: First press the Memory/Clk-Adj button and then the CD / Play/Pause button. The programmed song sequence will now be played again.

The programmed song sequence is deleted if ...

- the CD compartment is opened,
- the mini hi-fi system is switched to standby mode
- or the main switch on the back of the subwoofer is turned off.

11.9. Displaying additional information (only for MP3 CDs)

MP3 files are often saved with additional information (e.g. name of the artist, album, etc.). To display this additional information:

- 1 Hold the Find/Stereo button pressed while a song is being played.
 - 2 All available information for the current song will appear on the display screen. The following information is displayed ...
- File: Name of the MP3 file
 - Title: Title of the song
 - Artist: Artist or group performing the song
 - Album: Name of the album

Note:

Additional information is only displayed if this information was entered upon saving the MP3 file. As the case may be, some songs have no additional information or not all of the

above-mentioned information. This does not indicate faulty functioning of the mini hi-fi system.

- 3 To switch off the display of additional information: Press and hold the Find/Stereo button until the display returns to normal.

11.10. Search functions (only for MP3 CDs)

11.10.1. Search for file names

You can search for individual files on MP3 CDs according to the file names. You can also do this while a song is being played. To do this:

- 1 If a CD is being played, press the Stop button.
- 2 Then press the Find/Stereo button once. The first file name on the CD and "A" appear on the display screen. The magnifying glass symbol also blinks.

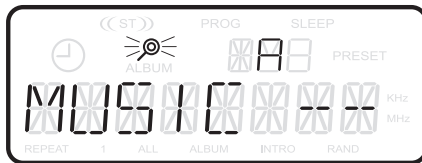

- 3 Now press the Up/FF button or the Down/REW button to find the initial letter of the desired file name. The next/previous letter of the alphabet will be displayed each time you press the Up/FF button or the Down/REW button. Under this, the first file name beginning with this letter is displayed. After the letter Z, the numbers 0 to 9 will be displayed. You can use this function to find file names beginning with numbers.
- 4 To display all file names beginning with the displayed letter: Press and hold the Up/FF button until the magnifying glass symbol on the display screen stops blinking.
- 5 Now press the Up/FF button or the Down/REW button to display the next/previous file name.

Note:

This function requires that several file names beginning with the displayed letter exist on the CD. If there are no file names with the displayed initial letter, then "Unknown" will appear on the display screen.

- 6 To select another initial letter: Press and hold the Up/FF button until the magnifying glass symbol on the display screen begins to blink again. You can display the next/previous initial letters by pressing the Up/FF button or the Down/REW button.
- 7 To play the desired MP3 file: Press the CD / Play/Pause button as soon as the name of the MP3 file is displayed.

- 8 If you would like to cancel the search without playing an MP3 file: Press the Find/Stereo button several times until the display returns to normal.

11.10.2. Searching for folder names

If the songs on a CD are organized in folder, you can search for a folder according to its name. You can also do this while a song is being played. To do this:

- 1 Press the Find/Stereo button two times. The name and number of the first folder, the magnifying glass and the album appear on the display screen.

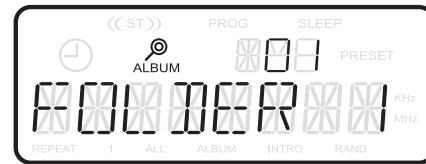

- 2 Now press the Up/FF button or the Down/REW button to display the next/previous folder.
- 3 To play the songs in the displayed folder, press the CD / Play/Pause button. The songs will be played in the order found in the folder.

12. General functions for radio and CD operation

12.1. Adjusting the volume

While using the radio, CD, and AUX functions, you can adjust the volume to values between 00 and 30.

To increase the volume: Turn the volume control knob to the right. The maximum volume is 30.

To decrease the volume: Turn the volume control knob to the left. The minimum volume is 00.

12.2. Muting the loudspeakers

To mute the loudspeakers during use of the radio, CD or AUX functions:

- 1 Press the Mute button. The loudspeakers are now muted and everything is blinking on the display screen.
- 2 To turn off the mute function, press the Mute button again.

12.3. Turning on the Equalizer function

The sound playback equalizer curve can be adjusted for radio, CD and AUX functions. You can choose from the equalizer

curves: "Pass", "Classic", "Rock", "Pop" and "Jazz". Each equalizer curve has its own characteristic emphasis on the high, mid and bass sounds. You can use this to adjust sound playback to suit different styles of music and your own personal preferences. To turn on the various different equalizer curves:

- 1 Press the EQ button. The currently selected equalizer curve appears on the display screen.
- 2 Another equalizer curve is displayed each time you press the EQ button. The equalizer curves are displayed in the following order: "Pass" → "Classic" → "Rock" → "Pop" → "Jazz".

You can turn off the equalizer function by selecting "Pass".

12.4. Adjusting the subwoofer

If the subwoofer of the mini hi-fi system is turned on, then bass sounds will be heard as fuller and more voluminous. This applies to operation of the radio, CD and AUX functions.

You can regulate the bass volume to suit your own personal preferences or individual pieces of music. To do this:

- 1 To increase the bass volume, turn the volume control knob on the front of the subwoofer to the right.
- 2 To decrease the bass volume, turn the volume control knob on the front of the subwoofer to the left.
- 3 To turn off the subwoofer function: Press the Power button on the front of the subwoofer. The subwoofer on/off indicator light goes off.

13. Additional functions of the mini hi-fi system

13.1. Adjusting the clock of the mini hi-fi system

The mini hi-fi system has to be in standby mode in order to adjust the integrated clock.

- 1 Press and hold the Memory/Clk-Adj button until 24 HOUR blinks on the display screen.
- 2 Switch between the display formats 24 HOUR and 12 HOUR using the Up/FF button or the Down/REW button.
 - 24 HOUR refers to the 24 hour display format as frequently used in most European/Asian countries.
 - 12 HOUR refers to the 12 hour AM/PM display format as frequently used in the U.S.A.

- 3 Press the Memory/Clk-Adj button to select the desired display format.
- 4 The hour indicator will blink on the display screen. Adjust the hour by pressing the Up/FF button or the Down/REW button.
- 5 Press the Memory/Clk-Adj button again to set the desired hour. The minute indicator will blink on the display screen.
- 6 Adjust the minute by pressing the Up/FF button or the Down/REW button.
- 7 Press the Memory/Clk-Adj button to set the desired minute. The time is set and will appear on the display screen.

13.2. Using the timer function

The timer function can be used to turn the mini hi-fi system on or off at a preprogrammed time. This function could be used to implement the mini hi-fi system as an alarm clock for example. To program the timer function:

- 1 If the mini hi-fi system is turned on: Press the Power button to switch the mini hi-fi system to standby mode.
- 2 Press and hold the timer button until the clock symbol and "On" appear on the display screen. The current timer setting is displayed and the hour indicator blinks.



Note:

You have ten seconds to carry out each of the steps 3 to 11. If you do not carry out a step within 10 seconds, you have to return to step 2.

- 3 Adjust the hour by pressing the Up/FF button or the Down/REW button.
- 4 Subsequently press the Timer button again to save the desired hour. The minute indicator will blink on the display screen.
- 5 Adjust the minute by pressing the Up/FF button or the Down/REW button.
- 6 Subsequently press the Timer button again to save the desired minute. The adjusted timer setting is saved. Now "Off" is blinking in place of "On" and the hour indicator is blinking again on the display screen. Now adjust the time that the timer should switch off.
- 7 Adjust the hour by pressing the Up/FF button or the Down/REW button.

- 8 Subsequently press the Timer button again to save the desired hour. The minute indicator will blink on the display screen.
- 9 Adjust the minute by pressing the Up/FF button or the Down/REW button.
- 10 Subsequently press the Timer button again to save the desired minute. The adjusted timer switch-off setting is now saved. "Tuner" blinks on the display screen.
- 11 Press the Up/FF button or the Down/REW button to select either Tuner or CD. If you select tuner, then the radio will be turned on at the time set for the timer to turn on and the radio will be turned off again at the time set for the timer to turn off. If you select CD, then the timer will start playing the CD in the CD compartment at the time set for the timer to turn on. Playback will be interrupted at the time set for the timer to turn off.



Note:

If you select CD, make sure that there is a CD in the CD compartment. Otherwise, the radio will be turned on at the time set for the timer to turn on.

- 12 To turn off the timer function: Press the Timer button on the remote control unit. The clock symbol disappears from the display screen. This functions while using the radio function, while playing CDs and in standby mode.

13.3. Using the sleep timer function

You can use the sleep timer to have the mini hi-fi system turn off automatically after a preprogrammed time period. This could be useful if you like to listen to music while going to sleep for example.

You can choose a time span between 10 and 90 minutes until which the mini hi-fi system turns off. To turn on the sleep timer:

- 1 Press the Sleep button while a CD is playing or while the radio is on. "Sleep" and 90 appear on the display screen. 90 refers to a time span of 90 minutes until automatic shut-off.

Each time you press the Sleep button, you switch to another time span.

- 2 As soon as the desired time span appears on the display screen: Wait for five seconds without pressing a button. The display returns to normal and "Sleep" appears in the display as well.

The mini hi-fi system will now be turned off automatically after the time span you have selected.

- 3 To turn the sleep timer off: Press the Sleep button repeatedly until the time span 0 is displayed. Wait for five seconds without pressing a button. The display returns to normal and "Sleep" disappears from the display.

14. Connecting headphones to the mini hi-fi system

If you would like to connect headphones to the mini hi-fi system: Insert the 3.5 mm plug of the headphones in the headphones jack on the front of the main unit.

The loudspeakers of the mini hi-fi system will be turned off automatically upon connecting headphones. Adjust the volume of the headphones using the volume control.

15. Connecting external audio devices to the mini hi-fi system

You can connect external audio devices to the mini hi-fi system using the AUX inputs. To do this:

Connect the AUX outputs of the external audio device with the AUX inputs of the mini hi-fi system. Use a cinch cable for this. You can obtain a cinch cable from your audio specialist shop.

After having connected the external audio device, make sure that it is ...

- operational,
- turned on and
- not muted.

Subsequently turn on the mini hi-fi system. Then select the AUX function by pressing the AUX button.

16. Cleaning the mini hi-fi system

Only use a slightly damp cloth to clean the casing of the mini hi-fi system and loudspeakers.

To remove persistent dirt, add a few drops of mild dishwashing liquid to the damp cloth. Make sure that no moisture enters the system while cleaning!

Clean the inside of the CD compartment (if necessary) only using a clean dry brush. Lens brushes obtainable from a photo specialist shop are especially suitable for this purpose.

Never clean the inside of the CD compartment with water!

! Warning!

If moisture enters the mini hi-fi system, it could cause electric shock and a fire!

17. Troubleshooting

17.1. Nothing appears on the display screen. The mini hi-fi system is not functioning even though it has been turned on.

- A** Make sure that the power plug of the mini hi-fi system is properly inserted in the electrical outlet.
- B** Make sure that the electrical outlet that you inserted the power plug in carries electrical current. To do this, connect device which is known to be functioning, to this power outlet.
- C** Press the Power button to switch the mini hi-fi system to the standby mode. Subsequently wait for ten seconds. Then turn the mini hi-fi system on again by pressing the Power button.

If the malfunction persists:

- D** Press the Power button to switch the mini hi-fi system to the standby mode. Switch the main switch on the back of the subwoofer to the Off position. Unplug the power plug from the electrical outlet. Wait for ten seconds.

Then insert the power cable plug into an electrical outlet again. Switch the main switch on the back of the subwoofer to the On position. Then turn the mini hi-fi system on again by pressing the Power button. See if the malfunction persists.

17.2. "No Disc" appears on the display screen even though a CD has been inserted.

- A** The CD is dirty, scratched or otherwise damaged. Clean the CD or insert another CD.
 - B** The CD has not been inserted properly in the CD compartment. Open the CD compartment by pressing the Open/Close button. Remove the CD and insert it again. Make sure that ...
- The labeled side of the CD is facing up.

→ The CD is properly placed on the spindle in the middle of the CD compartment.

C If you have inserted a CD-R/CD-RW: Sometimes, individual CD-Rs or CD-RWs can not be read/played. This can be caused by ...

- Quality differences between various different CD manufacturers,
- Differences between various different CD burners,
- Differences between various different programs used to burn CDs,
- or different settings used to burn CDs.

This does not indicate faulty functioning of the mini hi-fi system.

17.3. The inserted CD is not played

It is possible that a thin layer of condensation water has formed on the laser scanner lens in the CD compartment. This is especially likely if the mini hi-fi system has been exposed to extreme temperature changes.

In this case: Place the mini hi-fi system in a dry environment with room temperature and normal humidity levels. Then remove the CD from the CD compartment.

Subsequently leave the mini hi-fi system on for at least one hour without using it. The condensation layer should evaporate.

17.4. There is no sound

A Check to see if ...

- the mini hi-fi system may be muted. If the mini hi-fi system has been muted, then all elements of the display will blink.
- the loudspeaker connector cable are correctly inserted in the loudspeaker outputs on the back of the main unit.

B If an external audio device has been connected to the AUX inputs of the mini hi-fi system using a cinch cable: Check to see if ...

- the cinch cable plugs are correctly connected to the AUX inputs on the mini hi-fi system.
- the cinch cable plugs are correctly connected to the AUX outputs of the external audio device.

If the malfunction persists:

Check to see if the external audio device ...

- is muted
- is not turned on
- is not operational
- is not functional

If the malfunction persists:

Refer to the instruction for use of the external audio device. Check to see if settings have to be made in the audio device to connect it to hi-fi components.

17.5. The remote control unit is not working

- A** Make sure that the batteries for the remote control unit have been properly inserted in the battery compartment.
- B** The batteries of the remote control unit could be empty. In this case, exchange both batteries for new AAA/LR03/Micro type batteries.

 **Note:**

Do not dispose of used batteries in the household waste! Return the used batteries to an appropriate recycling collection center. Used batteries can usually be returned to the store in which they were bought.

- C** Check to see if there are any obstacles between the remote control unit and the infrared receiver on the main unit.
- D** Please note: The remote control unit only functions within a range of five meters from the main unit.

17.6. Other malfunctions

Please refer to one of our service partners in your area if ...

- the malfunctions described in sections 17.1. and 17.5. can not be rectified as described or
- other malfunctions occur while operating the mini hi-fi system.

The addresses of our service partners are found in the warranty booklet delivered with the mini hi-fi system.

 **Danger!**

In the case of malfunction, never attempt to repair the power supply cable yourself! This could cause danger of electric shock!

 **Warning!**

The mini hi-fi system and its components contain no user-serviceable parts. The warranty is voided if the casing of the mini hi-fi system, remote control unit and/or the loudspeakers is opened! For repairs, please contact your nearest service partner.

 **Note:**

No liability will be taken and no guarantee will be made for damages ...

- *resulting from opening the casing of the mini hi-fi system, remote control and/or loudspeakers,*
- *resulting from repair attempts not made by qualified experts.*

18. Disposing of the mini hi-fi system

Do not dispose of the mini hi-fi system or its components in the household waste. Please contact those responsible for waste management in your city or community and ask how this type of device is to be disposed of properly.

 **Note:**

Remove the batteries before disposing of the mini hi-fi system and/or the remote control unit. Do not dispose of the batteries in the household waste! Return the used batteries to an appropriate recycling collection center. Used batteries can usually be returned to the store in which they were bought.

Free Manuals Download Website

<http://myh66.com>

<http://usermanuals.us>

<http://www.somanuals.com>

<http://www.4manuals.cc>

<http://www.manual-lib.com>

<http://www.404manual.com>

<http://www.luxmanual.com>

<http://aubethermostatmanual.com>

Golf course search by state

<http://golfingnear.com>

Email search by domain

<http://emailbydomain.com>

Auto manuals search

<http://auto.somanuals.com>

TV manuals search

<http://tv.somanuals.com>