

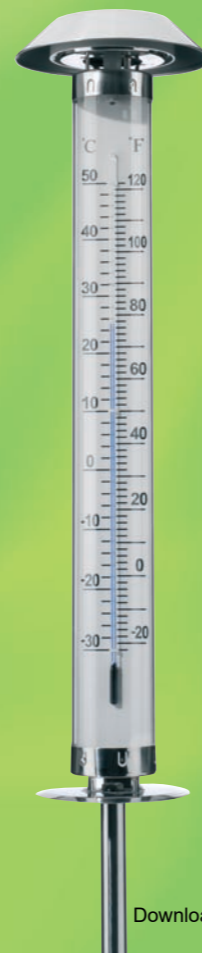

**Outdoor Thermometer with Solar Lamp**  
Operating and Safety Instructions





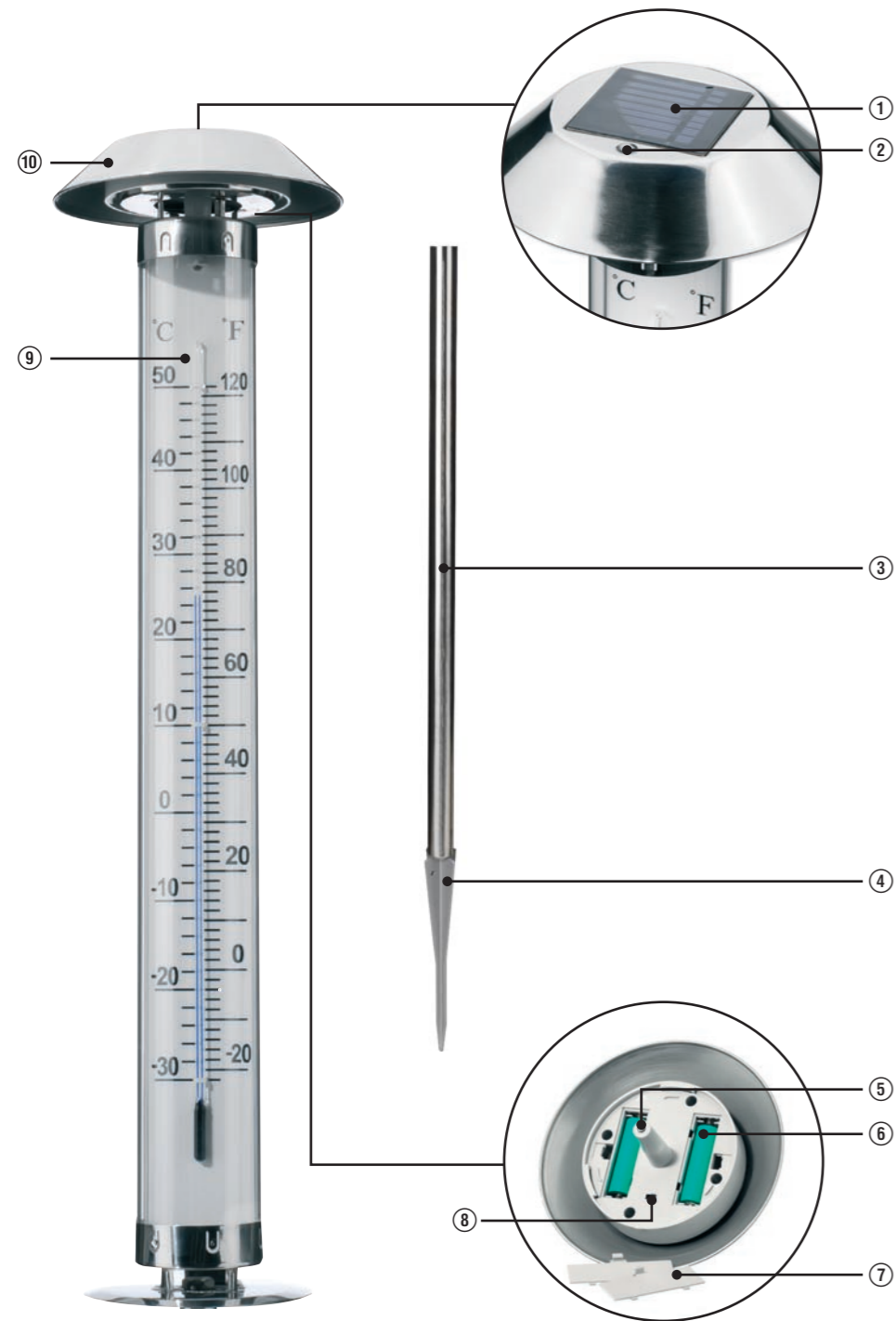

**KH 4122**

Operating and safety instructions ..... Page 5



Kompernaß GmbH  
Burgstraße 21 · D-44867 Bochum (Germany)

Validity Date of the Information: 02/2007  
BA-Ident-No.: KH4122 - 022007 - UK

	Before commencing to read, fold out the page with the illustrations and subsequently make yourself familiar with all functions of the appliance.	
<b>In these operating instructions the following Pictogram symbols are used:</b>		
	Read the operating instructions!	 Wear protective gloves.
	Important! Pay attention to the warning and safety!	

## Introduction

Intended purpose .....	Page 6
Equipment components .....	Page 6
Items supplied .....	Page 6
Technical Data .....	Page 6

## Safety

Safety Notices.....	Page 6
Product specific safety notices.....	Page 7

## Commissioning

Assembly / Location selection .....	Page 7
Switching the illumination on and off.....	Page 7
Exchanging batteries .....	Page 8

## Cleaning and Maintenance..... Page 8

## Disposal..... Page 8

## Information

Service.....	Page 9
Conformity Declaration / Importer .....	Page 9

## Outdoor Thermometer with Solar Lamp KH 4122

### Introduction



Before commissioning it for the first time make yourself familiar with all of the functions of the Outdoor Thermometer.

To do this, read the following operating instructions carefully. Retain these instructions for future reference. Also, pass them on to whoever might acquire the appliance at a future date.

### Intended purpose

The Outdoor Thermometer is intended as a measuring device for temperature display in garden areas or terraces. All other usages, or modifications to the appliance, are deemed to be improper applications and bring with them a high potential for serious accidents. The manufacturer accepts no liability for damage resulting from improper application. The appliance is intended for domestic use only.

### Equipment components

- ① Solar cell
- ② Photo-sensor
- ③ Supporting tube
- ④ Earth spike
- ⑤ Light Emitting Diode (LED)
- ⑥ Battery
- ⑦ Battery compartment lid
- ⑧ Auto-/OFF switch
- ⑨ Thermometer tube
- ⑩ Solar housing

### Items supplied

Immediately after unpacking check to ensure that all listed items are present and that all items are free of visible damage.

- 1 Solar housing
- 1 Thermometer tube
- 1 Support tube
- 1 Earth spike
- 2 Batteries 1,2V/700 mAh, Ni-MH/AA
- 1 Operating instructions

### Technical Data

Power supply:	2 x Batteries 700 mAh / Ni-MH, AA
Solar panel:	60 x 60 mm
Lighting duration:	12 hours with fully charged batteries
Light source:	1 x LED (Light Emitting Diode)
Protection class:	III
Protection type:	IPX 3
Temperature display:	LED KI.1 / 0,07W -30 °C - + 50 °C -20 °F - + 120 °F

### Safety



#### Safety Notices

- ⚠ **Warning! Mortal danger!** Batteries do not belong in the hands of children. Do not leave batteries lying around. There is a danger that they could be swallowed by children or pets. Should one be swallowed, immediately seek a doctor / veterinarian.
- Do not leave packaging material lying unattended. Plastik sheets/bags etc. can be dangerous toys for children.
- This product is not a toy, it does not belong in the hands of children. Children often do not comprehend the dangers inherent in electrical products.



## Product specific safety notices

- Do not subject the Outdoor Thermometer to extreme temperatures ( $< -25\text{ °C} / > +50\text{ °C}$ ), heavy vibrations or strong mechanical stresses.
- Ensure that the solar cell does not become dirty and is not covered with snow or ice in the winter. This reduces the performance capability of the solar cell.
- Cold temperatures have a negative influence on the battery operating period. If you do not need the Outdoor Thermometer for an extended period, e.g. in the winter, it should be switched off, cleaned and stored in a dry and warm area. Remove the batteries to avoid damage to the batteries themselves or to the solar housing.
- ⚠ **Warning!** Never open the solar housing. Arrange for repair or component exchange work to be carried out only by the Service Centre or qualified electricians.
- ⚠ **Warning!** The batteries may not be short-circuited. Overheating, fire risks or the exploding of the batteries could be the consequence.
- ⚠ **Warning! Risk of explosion!** Never throw batteries into water or a fire.
- Chemical fluids may leak from batteries that are very old or exhausted, and these fluids could damage the appliance. You should therefore remove the batteries if you do not require the Outdoor Thermometer for an extended period.
- Wear protective gloves:
  -  Leaking or damaged batteries can cause acid burns if they come into contact with bare skin, thus in these cases you should always wear suitable protective gloves.
- Use only batteries of the correct size and of the correct type.
- **Tip:** Ensure that when the Outdoor Thermometer is removed the support tube and the earth spike are also removed, to avoid any possible danger that they may cause (e.g. stumbling).

## Commissioning

### Assembly / Location selection

To obtain the optimal results, place the Outdoor Thermometer in a location at which the solar cell is subject to the maximum amount of direct sunlight.

- Do not place the Outdoor Thermometer under bushes, trees, overhangs etc which could reduce the total amount of sunlight received.
- Ensure that the solar cell ① and the photo sensor ② cannot be covered or come into shade.
- Ensure that the solar cell ① is not influenced by other light sources, e.g. house or street illumination. If it is, the lamp will not switch on at twilight.
- During the assembly and the placing of the appliance do not use force, e.g. hammer blows - these damage the product.
- Screw the temperature tube ⑨ onto the support tube ③.
- Insert the earth spike ④ into the support tube ③.
- Put the earth spike ④, on which the thermometer tube ⑨ and the support tube ③ are now placed, into the ground (lawn, flower-bed, etc).
- Ensure it is standing securely.
- Rotate the solar housing ⑩ carefully in a clockwise direction onto the thermometer tube ⑨.
- Remove the protective foil from the solar cell ① should one be placed over it.

### Switching the illumination on and off

The solar housing ⑩ requires ca. 2-3 sunny days to fully charge ⑥ the batteries. Initially, you should thus leave the solar lamp switched off for 2-3 days (Switch position "OFF").

- Remove the solar housing ⑩ by carefully rotating it anti-clockwise from the thermometer tube ⑨.
- On the underside of the solar housing ⑩ place the AUTO / OFF switch ⑧ to:

**AUTO:** The solar lamp is switched on. As the daylight reduces, the lamp switches on automatically.

**OFF:** The solar lamp is switched off. The batteries continue to be charged by the solar cell ①.

- Rotate the solar housing ⑩ carefully in a clockwise direction onto the thermometer tube ⑨.

**Notice:** The performance of solar light varies in accord with the season. In sunny weather the performance is higher than in cloudy weather.

## Exchanging batteries

**⚠ Attention! Risk of explosion!** Use exclusively batteries that are intended to be recharged and are designed for recharging.

To obtain the optimal performance, exchange batteries every 12 months.

- Remove the solar housing ⑩ by carefully rotating it anti-clockwise from the thermometer tube ⑨.
- Place the AUTO-/OFF switch ④ in the position OFF.
- Press the unlocking buttons of both battery compartments ⑦, open them and remove the used batteries ⑥.
- Insert new batteries of the same type and the same capacity (check the data on the original batteries) into the battery compartment. Ensure that the batteries ⑥ are inserted with the correct polarity (pay heed to Plus and Minus).
- Replace the battery compartment lids ⑦.
- Rotate the solar housing ⑩ carefully in a clockwise direction onto the thermometer tube ⑨.

**Notice:** The solar housing ⑩ requires ca. 2-3 sunny days to completely charge the batteries ⑥. Leave the solar lamp switched off for this period (Switch position "OFF").

## Cleaning and Maintenance

The Outdoor Thermometer is, except for required battery exchanges, maintenance-free. The LED is not exchangeable.

- Clean the solar housing ⑩ with a moist cloth to retain the optimal performance of the solar cell.
- Do not use solvents for cleaning and do not press too heavily on the solar housing ⑩.

## Disposal



The packaging comprises exclusively environmentally-friendly material which can be disposed of in your local recycling containers.



**Do not dispose of electrical appliances with your domestic waste!**

According to the European Directive 2002/96/EG, concerning used electrical and electronic appliances and its implementation in national law, superannuated electrical appliances must be collected and disposed of via an environmentally suitable recycling facility.

Defective or worn out rechargeable batteries must be recycled according to Directive 91/157/EEC. Dispose of batteries and appliances over the existing collection facilities.

Your local communal or municipal authorities can provide information on how to dispose of the worn out appliance.

 **Information** **Service**

DES Ltd  
Units 14-15  
Bilston Industrial Estate  
Oxford Street  
Bilston  
WV14 7EG  
Tel.: 0870/787-6177  
Fax: 0870/787-6168  
e-mail: support.uk@kompernass.com

 **Conformity Declaration /  
Importer** 

We, Kompernaß GmbH, Burgstr. 21, D-44867  
Bochum, Germany, hereby declare that this  
product complies with the requirements of  
the following EU directives:

**EN 60598-2-4:1997**

**EN 60825-1:2002**

**Product designation:**

Florabest Outdoor Thermometer with Solar Lamp  
KH4122

Bochum, 28.02.2007



Hans Kompernaß  
- Managing Director -

We reserve the right to make technical modifications in the  
course of further development.









## Free Manuals Download Website

<http://myh66.com>

<http://usermanuals.us>

<http://www.somanuals.com>

<http://www.4manuals.cc>

<http://www.manual-lib.com>

<http://www.404manual.com>

<http://www.luxmanual.com>

<http://aubethermostatmanual.com>

Golf course search by state

<http://golfingnear.com>

Email search by domain

<http://emailbydomain.com>

Auto manuals search

<http://auto.somanuals.com>

TV manuals search

<http://tv.somanuals.com>