

MINOLTA

The essentials of imaging

www.minolta.com

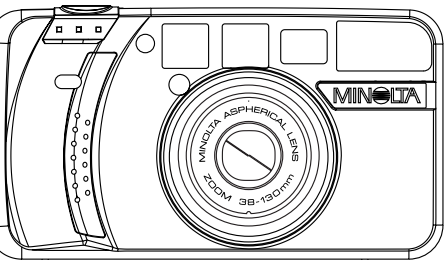

zoom 130c

Download from www.Somanuals.com. All Manuals Search And Download

E INSTRUCTION MANUAL

CONTENTS

Thank you for your purchasing this Minolta camera. Before using your new camera, please take the time to read through this instruction manual for it contains important information on the use and care of your camera.

For Proper and Safe Use 4

GETTING STARTED

Names of Parts..... 10

Attaching the Camera Strap 13

Inserting the Battery 14

Battery-condition Indicator 15

Loading the Film 16

BASIC OPERATION

Fully Automatic Operation 19

Focus Lock 22

Special Focusing Situations 23

For Closer Subjects 24

Rewinding the Film 26

ADVANCED OPERATION

Selecting the Flash Mode	28
Red-eye Reduction.....	29
Flash Range	30
Autoflash	31
Fill-flash	32
Flash cancel	33
Night Portrait	34
Landscape / Night View	35
Self-timer	36
For Owners of the Quartz-date model..	
.....	38
Date and Time Imprinting	38
Remote Control Operation	44

APPENDIX

Care and Storage	49
Technical Specifications	54

FOR PROPER AND SAFE USE

Read and understand all warnings and cautions before using this product.

WARNING

Using batteries improperly can cause them to leak harmful solutions, overheat, or explode which may damage property or cause personal injury. Do not ignore the following warnings:

- Only use the batteries specified in this instruction manual.
- Do not install the batteries with the polarity (+/-) reversed.
- Do not use batteries which show wear or damage.
- Do not expose batteries to fire, high temperatures, water, or moisture.
- Do not attempt to recharge, short, or disassemble batteries.
- Do not store batteries near or in metallic products.
- Do not use leaking batteries. If fluid from the batteries enters your eye, immediately rinse the eye with plenty of fresh water and contact a doctor. If fluid from the batteries makes contact with your skin or clothing, wash the area thoroughly with water.

- Tape over lithium battery contacts to avoid short-circuiting during disposal; always follow local regulations for battery disposal.
- Do not disassemble this product. Electric shock may cause injury if a high voltage circuit inside the product is touched. Take the product to a Minolta Service Facility when repairs are required.
- Immediately remove the batteries and discontinue use if the camera is dropped or subjected to an impact in which the interior, especially the flash unit, is exposed. The flash has a high voltage circuit which may cause an electric shock resulting in injury. The continued use of a damaged product or part may cause injuries.
- Keep batteries or small parts that could be swallowed away from infants. Contact a doctor immediately if an object is swallowed.
- Store this product out of reach of children. Be careful when around children, not to harm them with the product or parts.

FOR PROPER AND SAFE USE

- Do not fire the flash directly into the eyes. It may damage eyesight.
- Do not fire the flash at vehicle operators. It may cause a distraction or temporary blindness which may lead to an accident.
- Do not look directly at the sun or strong light sources through the viewfinder. It may damage your eyesight or cause blindness.
- Do not expose this product to liquids or operate this product with wet hands. If liquid enters the product, immediately remove the batteries and discontinue use. The continued use of a product exposed to liquids may cause damage or injury through fire or electric shock.
- Do not use the product near inflammable gases or liquids such as gasoline, benzene, or paint thinner. Do not use inflammable products such as alcohol, benzene, or paint thinner to clean the product. The use of inflammable cleaners and solvents may cause an explosion or fire.
- If the product emits a strange odor, heat, or smoke, discontinue use. Immediately remove the batteries taking care not to burn yourself. The continued use of a damaged product or part may cause injuries.

- Take the product to a Minolta Service Facility when repairs are required.

CAUTION

- Do not use or store the product in a hot or humid environment such as the glove compartment or trunk of a car. It may damage the product and batteries which may result in burns or injuries caused by heat, fire, explosion, or leaking battery fluid.
- If batteries are leaking, discontinue use of the product.
- The lens retracts when the camera is turned off or the auto-power-off function is activated. Touching the lens barrel while it is retracting may cause injury.
- Do not fire the flash while it is in contact with people or objects. The flash unit discharges a large amount of energy which may cause burns.

FOR PROPER AND SAFE USE

This device complies with Part 15 of the FCC Rules. Operation is subject to the following two conditions: (1) This device may not cause harmful interference, and (2) this device must accept any interference received, including interference that may cause undesired operation. Changes or modifications not approved by the party responsible for compliance could void the user's authority to operate the equipment. This equipment has been tested and found to comply with the limits for a Class B digital device, pursuant to Part 15 of the FCC Rules. These limits are designed to provide reasonable protection against harmful interference in a residential installation. This equipment generates, uses and can radiate radio frequency energy and, if not installed and used in accordance with the instructions, may cause harmful interference to radio communications. However, there is no guarantee that interference will not occur in a particular installation.

If this equipment does cause harmful interference to radio or television reception, which can be determined by turning the equipment off and on, the user is encouraged to try to correct the interference by one or more of the following measures:

- Reorient or relocate the receiving antenna.
- Increase the separation between the equipment and the receiver.
- Connect the equipment to an outlet on a circuit different from that to which the receiver is connected.
- Consult the dealer or an experienced radio/TV technician for help.

This Class B digital apparatus complies with Canadian ICES-003.



This mark on your camera certifies that this camera meets the requirements of the EU (European Union) concerning interference causing equipment regulations. CE stands for Conformité Européenne (European Conformity).

NAMES OF PARTS

BODY The **quartz-date model** is illustrated.

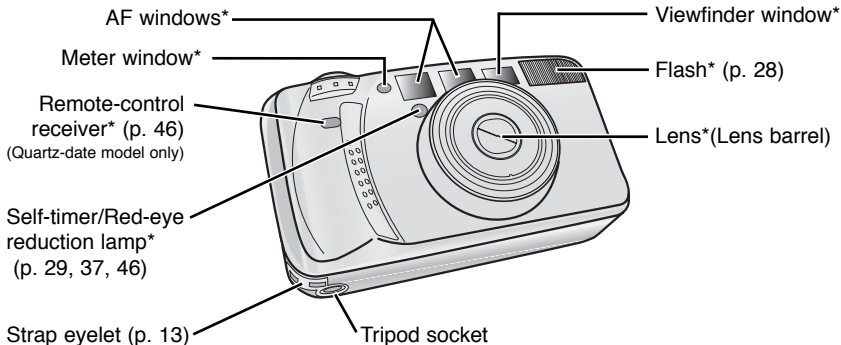

* This camera is a sophisticated optical instrument. Care should be taken to keep these surfaces clean. Refer to the care and storage section at the back of this manual (p. 51).

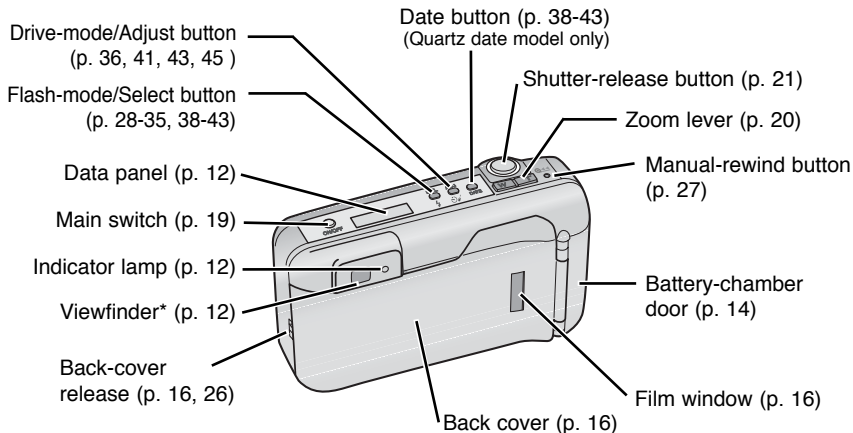

NAMES OF PARTS

DATA PANEL

Remote-control indicator (p. 45)
(Quartz-date model only)

Date/Time display (p. 38)
(Quartz-date model only)

Battery-condition
indicator (p. 15)



Flash-mode indicators (p. 28)

Self-timer indicator (p. 36)

Cartridge mark (p. 26)

Film-transport signals

Frame counter (p. 18)

All indicators are displayed for clarity.

VIEWFINDER

Focus frame

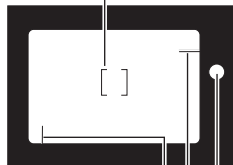

Close-framing guides (p. 24)

Indicator lamp

Glows steadily: Focus locked and
flash charged.
Blinks quickly: Subject is too close.
Blinks slowly: Camera-shake warning.

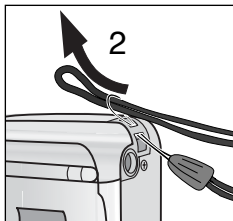
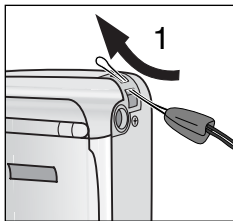

1. Pass the small loop of the strap through the strap eyelet on the camera.
2. Pass the the other end of the strap through the small loop and tighten.

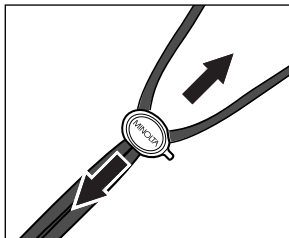

BUTTON KEY

- The button key is included on the strap. The key is used to push the manual-rewind button.

INSERTING THE BATTERY

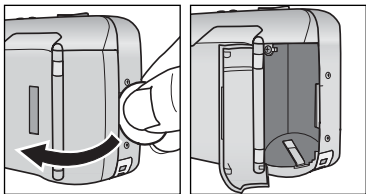

The camera uses one 3-volt CR123A or DL123A lithium battery.

1. Using a coin or similar object, open the battery chamber door.

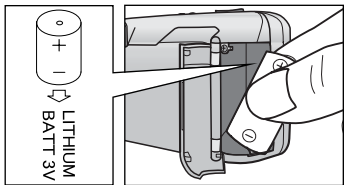

2. Insert the battery. The positive and negative battery terminals should be orientated as illustrated on the diagram in the battery chamber. Snap the door closed.

- Quartz-date model: after installing the battery, the date and time must be set, see page 40.
- When changing batteries, always turn the camera off.

Each time the camera is turned on, an indicator will appear on the data panel to indicate the power status of the battery.

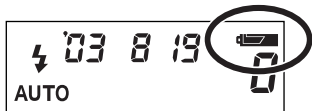

The indicator briefly appears. Power is sufficient for all camera operations.



The indicator blinks. Power is sufficient for camera operation, but the battery must be replaced soon.



The indicator blinks and no other indicators are displayed on the data panel. The shutter will not release. Replace the battery immediately.

LOADING THE FILM

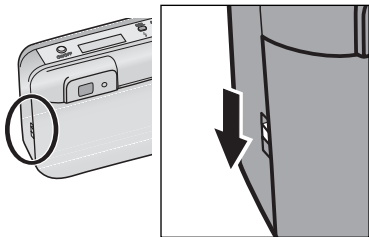

1. Slide the back-cover release down to open the back cover.

- Before opening the back cover, look through the film window to confirm that film is not currently loaded.

- If the back cover does not open, turn the camera off and on to release the film-chamber lock.
- Use only DX-coded 35mm film rated between ISO 25 and 3200.
- Do not use Polaroid instant 35mm film. Winding problems may result.
- ISO 400 film is recommended for best results.
- Always load and unload the film in subdued light.

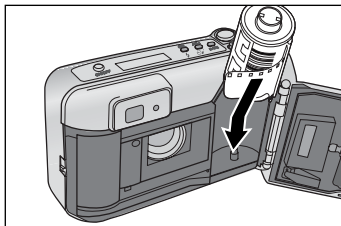

2. Place the film cartridge into the film chamber.

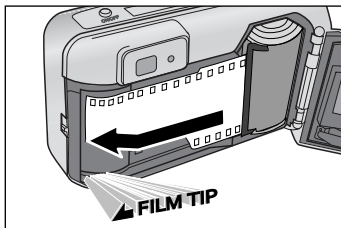

3. Extend the film leader to the film-tip mark. The film must lay flat.

- If the film tip extends beyond the index mark, push the excess film back into the cartridge.

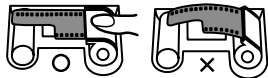

LOADING THE FILM

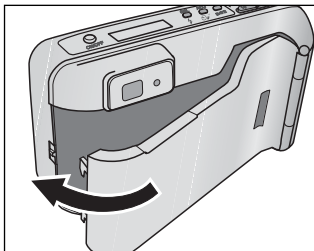

4. Close the back cover.

- The film automatically advances to the first frame and “1” appears in the data-panel frame counter.
- If the film has been loaded improperly, “0” will blink on the frame counter and the shutter will not release. Open the back cover and repeat the loading procedure.
- Once the film is loaded, the film-chamber lock will engage preventing the back cover from being accidentally opened until the film is rewound.

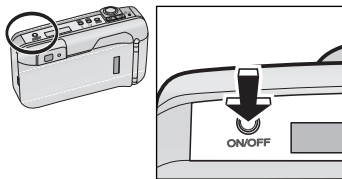

1. Press the main switch to turn the camera on.

- To conserve battery power, the auto-power-off function will turn the camera off eight minutes after the last operation.
- Do not obstruct or hold the lens barrel.

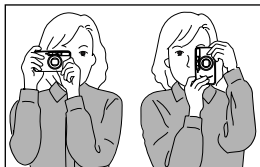

2. Hold the camera steadily. Do not cover the flash, lens, AF windows, or Meter window with your fingers.

- For vertically framed pictures, turn the camera so the flash is to the top.

FULLY AUTOMATIC OPERATION

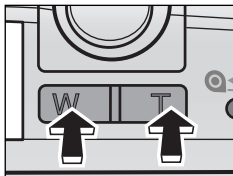
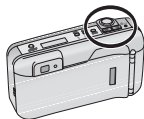

3. Look through the viewfinder and press the zoom lever to zoom the lens.

- The viewfinder will adjust to match the lens' field of view.

T(elephoto): zoom in



W(ide angle): zoom out

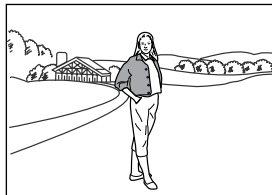



4. Place the subject within the focus frame and press the shutter-release button partway down.

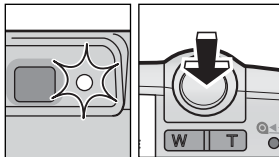

5. When the indicator lamp glows, press the shutter-release button all the way down to take the picture.

- Press the shutter-release button with slow, steady pressure.
- The film automatically advances to the next frame.
- After use, press the main switch to turn the camera off.
- The flash will fire automatically in low-light.

FOCUS LOCK

Subjects outside the focus frame may not be in focus. Use focus lock to ensure sharp pictures.



1. Place the focus frame on your subject.

2. Press and hold the shutter-release button partway down; the indicator lamp should glow to indicate focus lock.

- The indicator lamp confirms focus lock. If the lamp does not glow, repeat steps 1 and 2.

3. Without lifting your finger, recompose the picture. Press the shutter-release button all the way down to take the picture.

- The focus lock is canceled when the shutter button is released.

The camera may not be able to focus in certain situations. At this time, the focus-lock function (p. 22) can be used to focus on an object at the same distance as your subject, and then the image can be recomposed to take the picture.

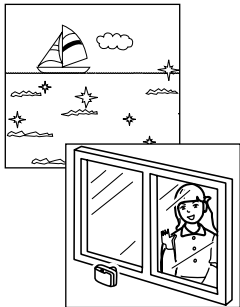

The autofocus system may not be able to focus on the following:

- Bright light sources such as neon signs.
- Highly reflective surfaces such as water or mirrors.
- Flames or fireworks.
- Dark objects and surfaces with low reflectance.
- Objects behind glass, bars, or other partitions.
- Objects smaller than the focus frames.

FOR CLOSER SUBJECTS

Close-framing guides

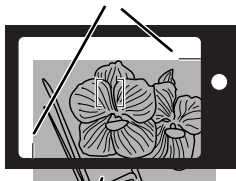

Actual image
(shaded area)

If the indicator lamp blinks rapidly, the subject is too close; the shutter cannot be released. Make sure the camera-to-subject distance is at least 70cm (2.3ft.) at the wide-angle setting or 80cm (2.6ft.) at the telephoto setting.

- When taking pictures at extremely close distances, the indicator lamp may blink slowly and the shutter can be released, but the focus may not be accurate.

When taking pictures with subjects closer than 1.5m (4.9ft.), the viewfinder image and the actual film image will be different. The difference increases as the subject becomes closer, especially when using the telephoto setting. At the closest focusing distance, the top and left side of the actual film image is indicated by the close-framing guides.



1. Place the focus frame on the subject and press the shutter-release button partway down. The indicator lamp will glow to indicate focus lock.



2. While pressing the shutter-release button partway down, recompose the picture so that the top and left edge of the area in the picture is aligned with the guides. Press the shutter-release button all the way down to take the photograph.

REWINDING THE FILM

The camera automatically rewinds the film after the last exposure is taken.



When the cartridge mark blinks on the data panel, the film has been rewound. Open the back cover and remove the film.

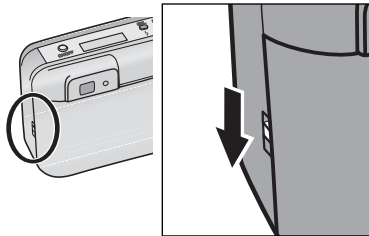

- The film-chamber lock is released during rewind. Do not open the back cover until the cartridge mark blinks on the data panel. Never force the back of the camera open.

- If the rewind motor stops before the film has been completely rewound, all the indicators on the data panel will blink. Remove and insert the battery .
- Although more pictures than specified on the film package may be taken, the film processor may only print the number specified on the film cartridge.

MANUAL REWIND

The film can be rewound before the roll is finished.

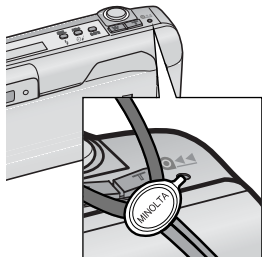

To rewind the film before finishing the roll, turn the camera on and gently press the manual-rewind button using the button key on the strap.

SELECTING FLASH MODE

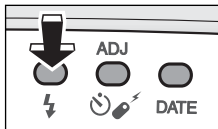

The camera has five flash-modes. Press the flash-mode button until the corresponding indicator is displayed on the data panel. Each time the flash-mode button is pressed the mode cycles as shown. When the camera is turned off, the mode is reset to autoflash.

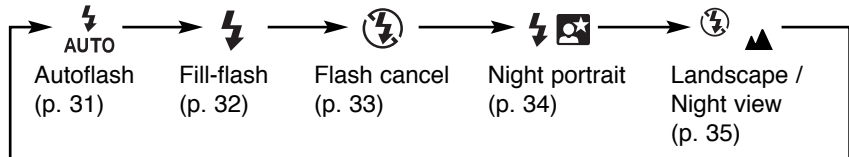

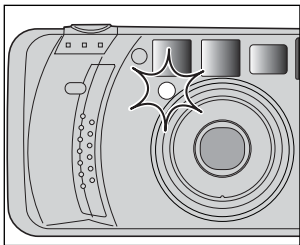

When the shutter-release button is pressed partway down, the self-timer/red-eye reduction lamp on the front of the camera will automatically glow to reduce the red-eye effect in portraits. Press the shutter-release button part way down for a few seconds before taking pictures. This function is active with all flash modes.

FLASH RANGE

The flash range depends on the film speed and focal length in use. Because of the optical system, the flash range is not the same at the lens' wide-angle position as it is at the telephoto position. To ensure proper exposure, the subject must be within the flash range.

Focal length \ Film speed	38 mm	130 mm
	W T	W T
	W(ide-angle)	T(elephoto)
ISO100	0.7 - 5.3 m (2.3 - 17.4 ft.)	0.8 - 1.6 m (2.6 - 5.2 ft.)
ISO400	0.7 - 10.6 m (2.3 - 34.8 ft.)	0.8 - 3.2 m (2.6 - 10.5 ft.)

The distances are based on use with color negative film.

The flash will fire automatically in low-light. This is the default flash mode.

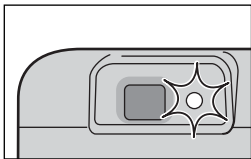

- The flash charges when the shutter-release button is pressed partway down. When the indicator lamp glows, the flash is charged and ready to fire.

FILL-FLASH



The flash will fire when the shutter is released regardless of lighting. Use fill flash to reduce harsh shadows on your subject's face, or in back-lit situations.

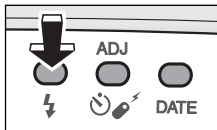

Press the flash-mode button until the fill-flash indicator (⚡) appears on the data panel. Take the picture as described in the basic operation section.





The flash will not fire. Use flash cancel when flash photograph is prohibited, the subject is beyond the flash range, or to preserve the natural lighting.

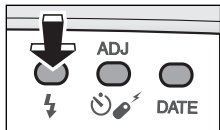

Press the flash-mode button until the flash-cancel indicator (⚡) appears on the data panel. Take the picture as described in the basic operation section.

- Shutter speed may be slow. The use of a tripod is recommended.

NIGHT PORTRAIT



In the night portrait mode, the camera balances the flash and existing light exposures for pictures of people in front of a sunset or night scene.

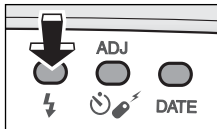

Press the flash-mode button until the night-portrait indicator (⚡★) appears on the data panel. Take the picture as described in the basic operation section.

- Shutter speed may be slow. The use of a tripod is recommended. Warn your subject not to move after the flash burst as the shutter may still be open for the background exposure.

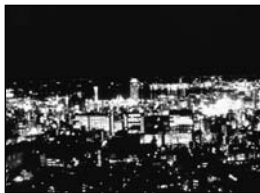

The flash will not fire in this mode and the focus is set to infinity. For photographs or landscapes, night scenery, or other distant subjects. This mode is especially useful when photographing landscapes through windows.

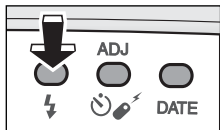

Press the flash-mode button until the landscape/night view indicator (⚡ ▲) appears on the data panel. Take the picture as described in the basic operation section.



- Shutter speed may be slow. Use of the tripod is recommended.

SELF-TIMER

The self-timer is used for taking self-portraits. The self-timer delays release of the shutter for approximately 10 seconds after the shutter-release button is pressed.

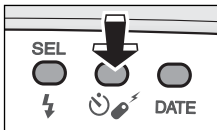
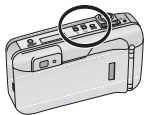

1. With the camera on a tripod, press the drive-mode button until the self-timer indicator appears on the data panel.

2. Place the subject in the focus frame and press the shutter-release button partway down to lock the focus and charge the flash.

- When the indicator lamp glows, the focus is locked; the picture can be recomposed.

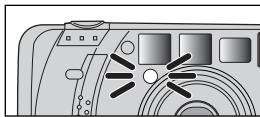

3. Press the shutter-release button all the way down to begin the countdown.

- The self-timer indicator will blink on the data panel. The self-timer lamp on the front of the camera will blink slowly during the countdown, then rapidly just before the shutter is released.

- The autofocus and exposure is locked when the shutter-release button is pressed. Do not stand in front of the camera when starting the self-timer.
- To cancel the self-timer, press the drive-mode button again or turn the camera off.
- Self-timer is automatically canceled after the shutter is released.

FOR OWNERS OF THE QUARTZ-DATE MODEL

The quartz-date model has date and time imprinting and remote-control operation.

DATE AND TIME IMPRINTING

The imprinting feature enables the date or time to be printed onto the lower-right portion of the picture. The date is recorded as the film is advanced to the next frame. The last picture on the roll may not be imprinted. The calendar is programmed through the year 2099.

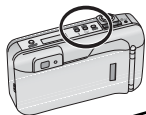

BUTTONS FOR THE DATE FUNCTION

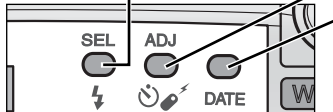

Select button

Adjust button

Date button

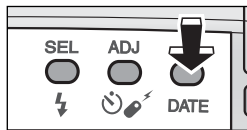
IMPRINTING THE DATE OR TIME

Press the date button to select the date imprinting format.

- The display will change as follows:



- If the date-time display blinks, the clock and calendar must be set. Only the no imprinting and set mode options are available.
- Since the date is recorded when the film is advanced to the next frame, the last frame of the roll may not have the date or time imprinted.

FOR OWNERS OF THE QUARTZ-DATE MODEL

SETTING THE DATE OR TIME

Note: the date and time must be reset each time the battery is replaced.

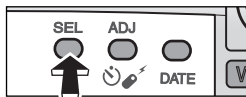
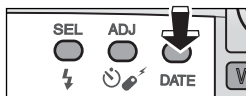

1. Turn the camera on. Press the date button until "SEt" appears on the data panel.

2. Press the select (SEL) button until the item to be adjusted blinks.

- Each time the select button is pressed, the next item on the calendar and clock blinks. The sequence is:

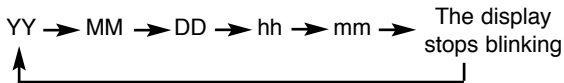

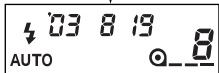
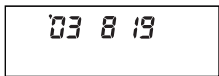
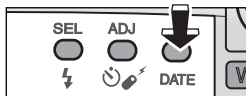
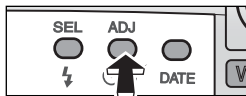

3. Press the adjust (ADJ) button or zoom lever to change the blinking item.

- The numerals continues to change as long as the button is held down.
- Pressing the W side of the zoom lever counts down, the T side counts up.

4. Repeat steps 2 and 3 until all items in the date and time display are correct.

5. Press the date button to set the date and time.

- The camera will return to the shooting mode automatically after five seconds. Pressing the date button again or pressing the shutter-release button partway down will also return the camera to the shooting mode.

FOR OWNERS OF THE QUARTZ-DATE MODEL

- Pressing the select (SEL) button until the date/time display stops blinking can also set the calendar and clock.

CHANGING THE DATE FORMAT

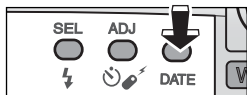

1. Press the date button until “SEt” appears on the data panel.

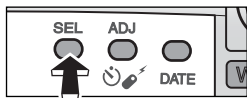

2. Press and hold the select (SEL) button for more than 2 seconds until all items on the date display blink.

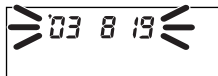

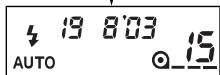
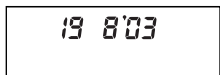
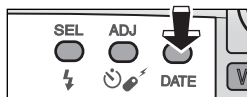
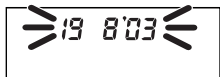
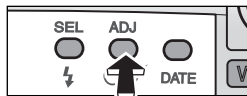

3. Press the adjust (ADJ) button or zoom lever to change the display format.

- The date format changes as follows:

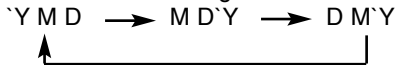

4. Press the date button to set the date format.

- The camera will return to the shooting mode automatically after five seconds. Pressing the date button again or pressing the shutter-release button partway down will also return the camera to the shooting mode.
- Pressing the select (SEL) button until the date/time display stops blinking can also set the date format.

FOR OWNERS OF THE QUARTZ-DATE MODEL

REMOTE CONTROL OPERATION

The quartz-date model can be controlled by the IR remote control RC-3 (sold separately). The remote control allows remote camera operation up to 5 meters (16.5 feet) away.

- Focus lock cannot be used with the IR remote control.

NAMES OF PARTS

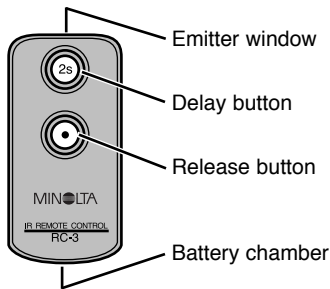

TAKING PICTURES USING THE REMOTE CONTROL

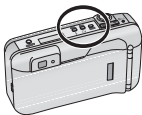

1. Place the camera on a tripod. Point the camera so that the subject is within in the focus frame.

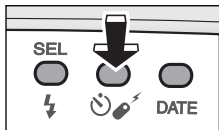

2. Press the drive-mode button until the remote-control indicator appears on the data panel.



FOR OWNERS OF THE QUARTZ-DATE MODEL

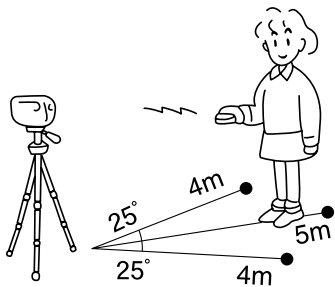

3. Point the remote control toward the front of the camera and press either the release button (•) or the delay button (2s) to take the picture.

- If the release button (•) is pressed, the self-timer lamp on the front of the camera will blink once before the picture is taken. If the delay button (2s) is pressed, the lamp will blink for two seconds before the picture is taken.

- To save power, the camera automatically shuts down if the shutter is not released in approximately 8 minutes.
- Under fluorescent or extremely bright lighting, or with backlit subjects, the remote control may not operate or the effective distance may be reduced.
- The remote control mode will remain in effect after the picture has been taken. Press the drive-mode button to reset the drive mode, or turn the camera off.

CHANGING THE REMOTE-CONTROL BATTERY

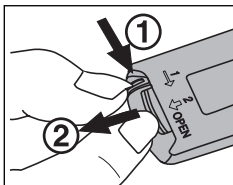

The remote control uses a 3V lithium battery (CR2032). When pressing the remote-control buttons does not release the shutter, the battery needs to be replaced. The supplied battery should be sufficient for approximately ten years of operation.

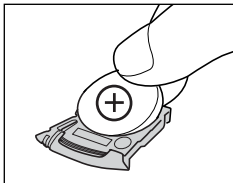

- 1. Pull out the battery chamber as shown and remove the old battery.**
- 2. Insert a new battery into the battery chamber with the positive (+) pole up.**
- 3. Slide the battery chamber into the remote control.**

MINOLTA HISTORY

On February 20th, 1962, John Glenn became the first American to orbit the Earth. On board his Friendship 7 spacecraft was a Minolta Hi-matic camera to record that historic event. The 4 hour, 55 minute, and 23 second flight orbited the Earth three times at an average speed of 28,000 kph (17,500 mph).

Mr. Glenn visited our Sakai camera factory in Japan on May 24th, 1963 to plant a palm tree to celebrate the occasion. The palm tree is still in the courtyard of the factory and stands over eight meters tall (26ft).

The camera? It was not lost. It is on display at the Smithsonian Institution's National Air and Space Museum in Washington D.C. This and other objects from John Glenn's Friendship 7 Mercury flight can be found in gallery 210, "Apollo to the Moon."



OPERATING TEMPERATURE AND CONDITIONS

- This camera is designed for use from -10 to 40°C (14 to 104°F).
- Never leave the camera where it may be subjected to extreme temperatures such as in the glove compartment of a car.
- At colder temperatures, the data panel response time will be slow. At higher temperatures, the display will temporarily darken, but will be restored when the temperature normalizes.
- Never subject the camera to extreme humidity.
- To prevent condensation from forming, place the camera in a sealed plastic bag when bringing it from a cold environment into a warm one. Allow it to come to room temperature before removing it from the bag.



CARE AND STORAGE

- When photographing in cold weather, it is recommend that you keep the camera and spare batteries inside your coat to keep them warm when you are not shooting. Cold batteries will regain some of their charge when they warm up.
- This camera is not waterproof, dust-proof, or sand-proof. Care should be taken when using of this camera near water or the beach to protect it from damage caused by water, dust, or sand. Protect the camera from moisture or splashes, especially saltwater spray. Be extremely careful to protect the interior and exterior of the camera and its accessories from sand.

CLEANING

- Keep the AF window clean to ensure accurate focus.
- If the camera body is dirty, gently wipe it clean with a soft, clean, dry cloth.
- To clean the lens surface, first brush away any dust or sand then, if necessary, moisten a lens tissue with lens cleaning fluid and gently wipe the lens in a circular motion, starting from the center.
- Never place lens fluid directly on the lens.
- Never touch the lens surface with your fingers.
- Never use alcohol or solvents to clean the camera.



CARE AND STORAGE

STORAGE

When storing the camera for extended periods, please follow these guidelines:

- Store the camera in a cool, dry, well-ventilated area away from dust and chemicals. For very long periods, place the camera in an airtight container with a silica gel drying agent.
- After prolonged storage, always check the camera's operation to make sure it is functioning properly.

BEFORE IMPORTANT EVENTS

- Check camera operation carefully and take test photographs. Purchase a spare battery.
- Minolta is not responsible for any loss which may occur due to an equipment malfunction.

CAMERA ERROR

If all the indicators on the data panel blink, or the data panel is blank and the camera will not function with a recently installed battery, remove and reinsert the battery. If the camera does not resume normal operation, or the camera malfunctions repeatedly, contact an authorized Minolta Service Facility.

QUESTIONS AND SERVICE

- If you have questions about your camera, contact your local camera dealer or write to the Minolta distributor in your area.
- Before shipping your camera for repair, please contact an authorized Minolta Service Facility for details.

TECHNICAL SPECIFICATIONS

Camera Type:	35mm lens-shutter camera
Lens:	38-130mm f/5.4 - 12.5 lens 4 elements in 4 groups
Focusing Range:	(W): 0.7m - ∞ (2.3 ft - ∞) (T): 0.8m - ∞ (2.6 ft - ∞)
Film Speed:	Settings Automatic for DX-coded film. Non-DX coded film set to ISO25. Range ISO 25 to 3200
Metering Range	Wide: Ev 6 - 16
(ISO 100):	Tele: Ev 6 - 16
Shutter Speed:	4 - 1/500 sec.
Flash Range	Wide: 0.7 - 5.3 m (2.3 - 17.4 ft.)
(ISO 100):	Tele: 0.8 - 1.6 m (2.6 - 5.2 ft.)
Battery:	One 3-volt CR123A lithium battery Battery-condition indication: 3-stage indication Battery performance: approx. 13 rolls based on Minolta's standard test method using 24-exposure rolls with flash for 50% of the exposures.

Viewfinder:	Magnification: 0.4X - 1.24X Field of View: 86% (at 3m) Eye-relief: 18mm from the viewfinder frame
Dimensions:	114 x 62.5 x 46 mm 4.5 x 2.5 x 1.8 in
Weight:	195g (6.9 oz.) without battery

Specifications are based on the latest information available at the time of printing and are subject to change without notice.

Minolta Co., Ltd.	3-13, 2-Chome, Azuchi-Machi, Chuo-Ku, Osaka 541-8556, Japan
Minolta Europe GmbH Reparatur/Repair	Minoltaring 11, D-30855 Langenhagen, Germany
Minolta France S.A.S.	Senator-Helmken-Strasse 1, D-28197 Bremen, Germany
Minolta (UK) Limited	365 Route de Saint-Germain, F-78420 Carrières-Sur-Seine, France
Minolta Austria Ges. m.b.H.	7 Tanners Drive, Blakelands, Milton Keynes, MK14 5BU, England
Minolta Camera Benelux B.V. Belgian Branch	Amalienstrasse 59-61, A-1131 Wien, Austria
Minolta (Schweiz) AG	Zonnebaan 39, P.O. Box 6000, NL-3600 HA Maarssen, The Netherlands
Minolta Svenska AB Finnish Branch	Prins Boudewijnlaan 1, B-2550 Kontich, Belgium
Minolta Portugal Limitada	Riedstrasse 6, CH-8953 Dietikon, Switzerland
Minolta Corporation	Albygatan 114, S-171 54 Solna, Sweden
Minolta Canada Inc.	Niittykatu 6 PL 37, SF-02201 Espoo, Finland
Minolta Hong Kong Limited	Av. do Brasil 33-A, P-1700 Lisboa, Portugal
Minolta Singapore (Pte) Ltd.	101 Williams Drive, Ramsey, New Jersey 07446, U.S.A.
Shanghai Minolta Optical Products Co., Ltd.	369 Britannia Road East, Mississauga, Ontario L4Z 2H5, Canada
	Room 208, 2/F, Eastern Center, 1065 King's Road, Quarry Bay, Hong Kong
	10, Teban Gardens Crescent, Singapore 608923
	368 Minolta Road, Songjiang, Shanghai, China

© 2003 Minolta Co., Ltd. under the Berne Convention and Universal Copyright Convention



9222-2481-11 NI-A305

Printed in China

Download from www.Somanuals.com. All Manuals Search And Download.

Free Manuals Download Website

<http://myh66.com>

<http://usermanuals.us>

<http://www.somanuals.com>

<http://www.4manuals.cc>

<http://www.manual-lib.com>

<http://www.404manual.com>

<http://www.luxmanual.com>

<http://aubethermostatmanual.com>

Golf course search by state

<http://golfingnear.com>

Email search by domain

<http://emailbydomain.com>

Auto manuals search

<http://auto.somanuals.com>

TV manuals search

<http://tv.somanuals.com>