

# MINOLTA

The essentials of imaging

[www.minolta.com](http://www.minolta.com)

# DYNAX 4 DYNAX 3 MAXXUM 4

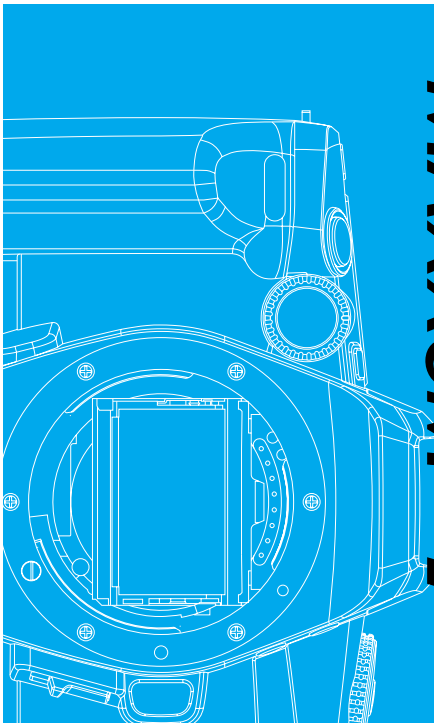

**E** INSTRUCTION MANUAL

APPENDIX

CUSTOM  
FUNCTIONS

DETAILED  
OPERATION

CREATIVE  
EXPOSURE

SUBJECT /  
DRIVE

AUTOMATIC  
OPERATION

GETTING  
STARTED

# TABLE OF CONTENTS

The **GETTING STARTED** section describes how to prepare the camera for use. The **FULLY-AUTOMATIC OPERATION** chapter shows how to take photographs quickly and simply by using the camera's automatic features. Advanced shooting features are covered in **SUBJECT PROGRAM / DRIVE MODES**. The **CREATIVE EXPOSURE MODE** section introduces exposure control. The **DETAILED OPERATION** section describes advanced functions within the camera. The last section, **CUSTOM FUNCTIONS**, shows how to customize camera operation. Custom Function Notes have been inserted throughout the manual as reference to camera operations that can be changed.

<b>FOR PROPER AND SAFE USE</b> .....	7
<b>QUICK OPERATION</b> .....	10
<b>NAMES OF PARTS</b> .....	12
Body .....	12
Data Panel .....	14
Viewfinder.....	15

## GETTING STARTED

<b>GETTING STARTED</b> .....	17
<b>STRAP</b> .....	17
Attaching the Strap .....	17
Using the Eyepiece Cap .....	18
<b>BATTERIES</b> .....	19
Installing the Batteries .....	19
Battery Condition Indicators.....	20
Changing the Batteries - Quartz-date model .....	21
<b>LENS</b> .....	22
Attaching the Lens .....	22
Removing the Lens .....	22
<b>FILM</b> .....	23
Loading the Film .....	23
Film Chamber Lock .....	25
Rewinding the Film .....	26
Manual Rewind .....	26

## AUTOMATIC OPERATION

### FULLY-AUTOMATIC OPERATION

<b>HANDLING THE CAMERA</b> .....	28
Pressing the Shutter-release Button .....	28
Holding the Camera .....	28
<b>AUDIO SIGNAL</b> .....	29
<b>TAKING PICTURES IN FULL-AUTO</b> .....	30
<b>FOCUS</b> .....	32
Focus Signals.....	32
Special Focus Situations .....	33
<b>FOCUS LOCK</b> .....	34
<b>USING THE BUILT-IN FLASH</b> .....	35
Flash Signals .....	35
Flash Range.....	36
Lens Shadowing.....	36
⚡ Fill Flash .....	37
🔄 Flash Cancel .....	37
👁 Red-eye Reduction .....	38

## SUBJECT / DRIVE

### SUBJECT PROGRAM / DRIVE MODES

<b>SUBJECT PROGRAM SELECTION</b> .....	40
👤 Portrait .....	40
🏞 Landscape .....	41
📷 Close-up.....	42
🏃 Sports.....	43
🌃 Night Portrait .....	44
🌃 Photographing Night Scenes .....	45
<b>DRIVE MODES</b> .....	46
🕒 Self-timer .....	46
📄 Continuous Advance .....	48
🔗 For Owners of the Remote-control Function .....	49
🔗 Focus Lock in Remote Control Mode .....	50

GETTING STARTED

AUTOMATIC OPERATION

SUBJECT / DRIVE

CREATIVE EXPOSURE

DETAILED OPERATION

CUSTOM FUNCTIONS

APPENDIX

**TABLE OF CONTENTS**

<b>CREATIVE EXPOSURE</b>	<b>CREATIVE EXPOSURE MODES</b>	
	<b>APERTURE CONTROL</b> .....	52
	<b>SHUTTER CONTROL</b> .....	53
	<b>EXPOSURE MODES</b> .....	54
	<b>A MODE (APERTURE PRIORITY)</b> .....	55
	Flash With A Mode .....	57
	<b>S MODE (SHUTTER PRIORITY)</b> .....	58
	Flash With S Mode .....	59
	<b>M MODE (MANUAL)</b> .....	60
	Metering in Manual Mode .....	61
	Flash With M Mode .....	62
	<b>P MODE</b> .....	63
	PA mode .....	63
	Ps mode .....	64
	<b>EXPOSURE WARNINGS</b> .....	65
<b>DETAILED OPERATION</b>	<b>DETAILED OPERATION</b>	
	<b>FOCUS AREA</b> .....	67
	Wide Focus Area .....	67
	Spot Focus Area .....	68
	Local Focus Areas .....	69
	Focus Area Selection controls .....	70
	<b>FOCUS MODES</b> .....	71
	⬆ Automatic AF .....	71
	Ⓞ Continuous AF .....	72
	Ⓢ Single-shot AF .....	73
	ⓂⓂ Manual Focus .....	74
	<b>AF ILLUMINATOR</b> .....	75
	<b>EXPOSURE</b> .....	76
	14-Segment Honeycomb Pattern Metering .....	76
	Spot Metering .....	76
■ Spot-AE Lock .....	77	
<b>TAKING TIME EXPOSURES (buLb)</b> .....	79	
<b>EXPOSURE COMPENSATION</b> .....	82	
Checking Exposure Compensation .....	83	

<b>DETAILED OPERATION</b>	<b>SETTING THE ISO MANUALLY</b> .....	84
	<b>EXPOSURE BRACKETING</b> .....	85
	Continuous Advance Bracketing .....	86
	Single Frame Advance Bracketing .....	86
	Flash Notes .....	87
	Bracketing with the Exposure-compensation Button ..	87
	<b>MULTIPLE EXPOSURE</b> .....	88
	Metering Multiple Exposure .....	90
	<b>FLASH</b> .....	91
	Program Flash .....	91
	Attaching the Program Flash .....	92
	Flash Metering .....	92
	<b>SLOW-SYNC</b> .....	94
	<b>WIRELESS/REMOTE FLASH</b> .....	95
	Setting Wireless/Remote Flash Mode .....	96
Taking Pictures in Wireless/Remote Flash Mode .....	97	
<b>CUSTOM FUNCTIONS</b>	<b>FOR OWNER'S OF THE QUARTZ DATE MODEL</b> .....	100
	Setting the Date or Time .....	100
	Imprinting the Date or Time .....	101
Changing the Date Format .....	102	
<b>APPENDIX</b>	<b>CUSTOM FUNCTIONS</b> .....	103
	<b>APPENDIX</b> .....	112
	<b>PROGRAM-RESET BUTTON</b> .....	113
	<b>ACCESSORY INFORMATION</b> .....	114
	<b>TROUBLE SHOOTING</b> .....	118
	<b>CARE AND STORE</b> .....	120
	<b>SPECIFICATIONS</b> .....	122
	<b>INDEX</b> .....	124
	<b>MEMO</b> .....	126

**GETTING STARTED**  
**AUTOMATIC OPERATION**  
**SUBJECT / DRIVE**  
**CREATIVE EXPOSURE**  
**DETAILED OPERATION**  
**CUSTOM FUNCTIONS**  
**APPENDIX**

## FOR PROPER AND SAFE USE

**Thank you for purchasing this camera. Please take time to read this manual so that you can enjoy all the features of your new camera. This manual has been designed to help you understand the camera's operation quickly. The information in this manual is relevant for products introduced before May, 2002. Contact the nearest authorized Minolta Service facility to obtain compatibility information for products released after this date.**

**This camera is designed to work specifically with lenses and accessories manufactured and distributed by Minolta. Using incompatible accessories with this camera may result in unsatisfactory performance or damage the camera and accessories.**

This device complies with Part 15 of the FCC Rules. Operation is subject to the following two conditions: (1) This device may not cause harmful interference, and (2) this device must accept any interference received, including interference that may cause undesired operation. Changes or modifications not approved by the party responsible for compliance could void the user's authority to operate the equipment. This equipment has been tested and found to comply with the limits for a Class B digital device, pursuant to Part 15 of the FCC Rules. These limits are designed to provide reasonable protection against harmful interference in a residential installation. This equipment generates, uses and can radiate radio frequency energy and, if not installed and used in accordance with the instructions, may cause harmful interference to radio communications. However, there is no guarantee that interference will not occur in a particular installation. If this equipment does cause harmful interference to radio or television reception, which can be determined by turning the equipment off and on, the user is encouraged to try to correct the interference by one or more of the following measures:

- Reorient or relocate the receiving antenna.
- Increase the separation between the equipment and the receiver.
- Connect the equipment to an outlet on a circuit different from that to which the receiver is connected.
- Consult the dealer or an experienced radio/TV technician for help.

This Class B digital apparatus complies with Canadian ICES-003.



This mark on the bottom of your camera is there to inform you that this camera meets the requirements of the EU (European Union) concerning interference causing equipment regulations. CE stands for Conformité Européenne (European Conformity).

Read and understand all warnings and cautions before using this product.

### WARNING

Using batteries improperly can cause them to leak harmful solutions, overheat, or explode which may damage property or cause personal injury. Do not ignore the following warnings.

- Only use the batteries specified in this instruction manual.
- Do not install the batteries with the polarity (+/-) reversed.
- Do not use batteries which show wear or damage.
- Do not expose batteries to fire, high temperatures, water, or moisture.
- Do not attempt to short or disassemble batteries.
- Do not store batteries near or in metallic products.
- Do not mix batteries of different types, brands, or ages.
- Do not use leaking batteries. If fluid from the batteries enters your eye, immediately rinse the eye with plenty of fresh water and contact a doctor. If fluid from the batteries makes contact with your skin or clothing, wash the area thoroughly with water.
- Tape over lithium battery contacts to avoid short-circuiting during disposal; always follow local regulations for battery disposal.
- Do not disassemble this product. Electric shock may cause injury if a high voltage circuit inside the product is touched. Take the product to a Minolta Service Facility when repairs are required.

## FOR PROPER AND SAFE USE

### **WARNING**

- Immediately remove the batteries and discontinue use if the camera is dropped or subjected to an impact in which the interior, especially the flash unit, is exposed. The flash has a high voltage circuit which may cause an electric shock resulting in injury. The continued use of a damaged product or part may cause injuries.
- Keep batteries or small parts that could be swallowed away from infants. Contact a doctor immediately if an object is swallowed.
- Store this product out of reach of children. Be careful when around children, not to harm them with the product or parts.
- Do not fire the flash directly into the eyes. It may damage eyesight.
- Do not fire the flash at vehicle operators. It may cause a distraction or temporary blindness which may lead to an accident.
- Do not look at the sun or strong light sources directly through the viewfinder or lens. It may damage your eyesight or cause blindness.
- Do not expose this product to liquids or operate this product with wet hands. If liquid enters the product, immediately remove the batteries and discontinue use. The continued use of a product exposed to liquids may cause damage or injury through fire or electric shock.
- Do not use the product near inflammable gases or liquids such as gasoline, benzine, or paint thinner. Do not use inflammable products such as alcohol, benzine, or paint thinner to clean the product. The use of inflammable cleaners and solvents may cause an explosion or fire.
- If the product emits a strange odor, heat, or smoke, discontinue use. Immediately remove the batteries taking care not to burn yourself. The continued use of a damaged product or part may cause injuries.
- Take the product to a Minolta Service Facility when repairs are required.

8

### **CAUTION**

- Do not point the product directly at the sun. If sunlight is focused on an inflammable surface, a fire may result. Replace the lens cap when the product is not in use.
- Do not use or store the product in a hot or humid environment such as the glove compartment or trunk of a car. It may damage the product and batteries which may result in burns or injuries caused by heat, fire, explosion, or leaking battery fluid.
- If batteries are leaking, discontinue use of the product.
- Do not fire the flash while it is in contact with people or objects. The flash unit discharges a large amount of energy which may cause burns.
- Do not apply pressure to the data panel. A damaged panel may cause injury, and the liquid from the panel may cause inflammation. If liquid from the panel makes contact with skin wash the area with fresh water. If liquid from the panel comes in contact with the eyes, immediately rinse the eyes with plenty of water and contact a doctor.

9

## QUICK OPERATION

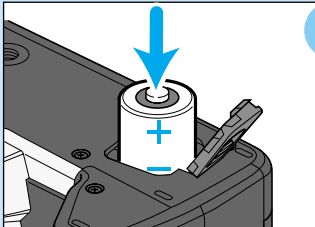

### 1 Insert batteries.

- This camera uses two CR2 lithium batteries. [p.19](#)

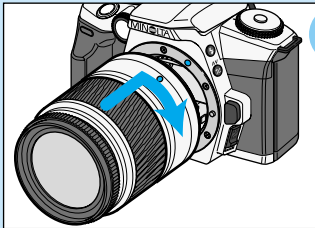

### 2 Attach the lens.

- Align the red mounting index on the lens with the one on the camera. Carefully insert the lens into the mount and turn it clockwise until it clicks into the locked position. [p.22](#)

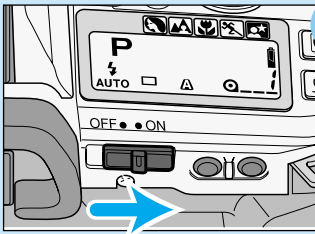

### 3 Slide the main switch to ON.

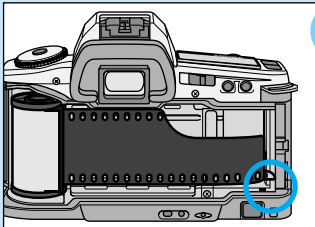

### 4 Load the film.

- Align the film tip with the red mark, then close the back cover. [p.23](#)

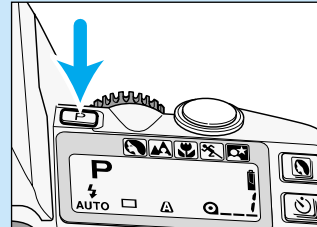

### 5 Set full-auto operation.

- Press the program-reset button to set the camera to fully automatic operation. [p.30](#)

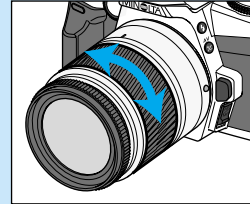

### 6 Center your subject in the wide focus frame [ ]. If using a zoom lens, rotate the zooming ring to frame your subject as desired.

- The camera will focus and set exposure automatically when the shutter release button is pressed partway down. [p.28](#)
- The audio signal confirms the camera has focused when the shutter release button is pressed partway down. [p.29](#)

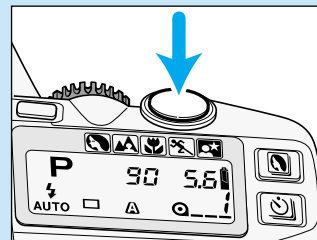

### 7 When ● or ● appears in the viewfinder, press the shutter-release button all the way down to take the picture.

- Use focus lock if your subject is off-center and outside the focus frame. [p.32](#)

## NAMES OF PARTS

### Body

For information on specific parts, refer to the page shown in parentheses.

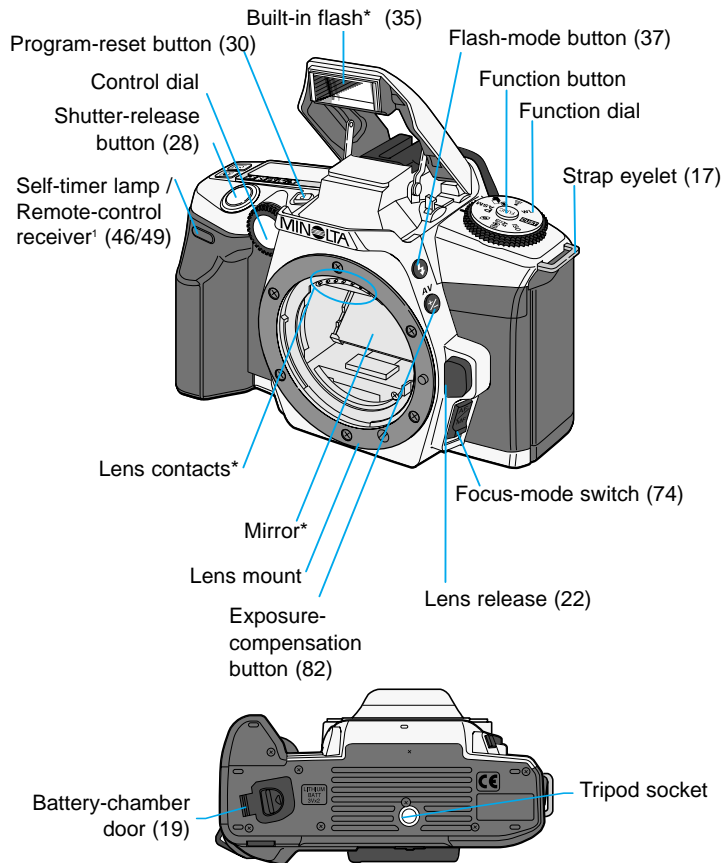

12

**\*This camera is a sophisticated optical instrument. Care should be taken to keep these surfaces clean. Please read the care and storage instructions in the back of this manual (p. 122).**

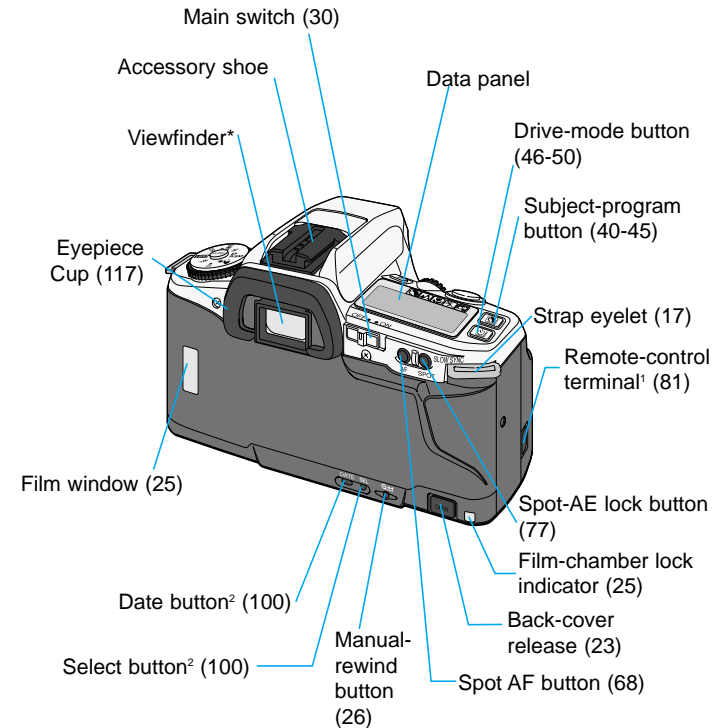

<sup>1</sup>Available on the remote-control model only.

<sup>2</sup>Available on the quartz-date model only.

The quartz-date model is equipped with remote-control function.

13

## NAMES OF PARTS

### Data Panel

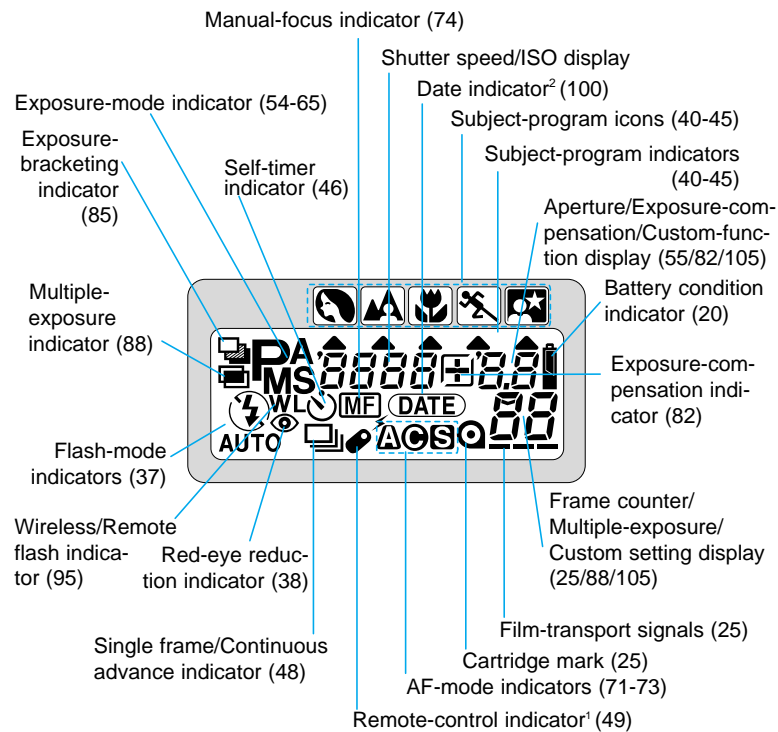

<sup>1</sup>Available on the remote-control model only.

<sup>2</sup>Available on the quartz-date model only.

The quartz-date model is equipped with a remote-control function.

### Viewfinder

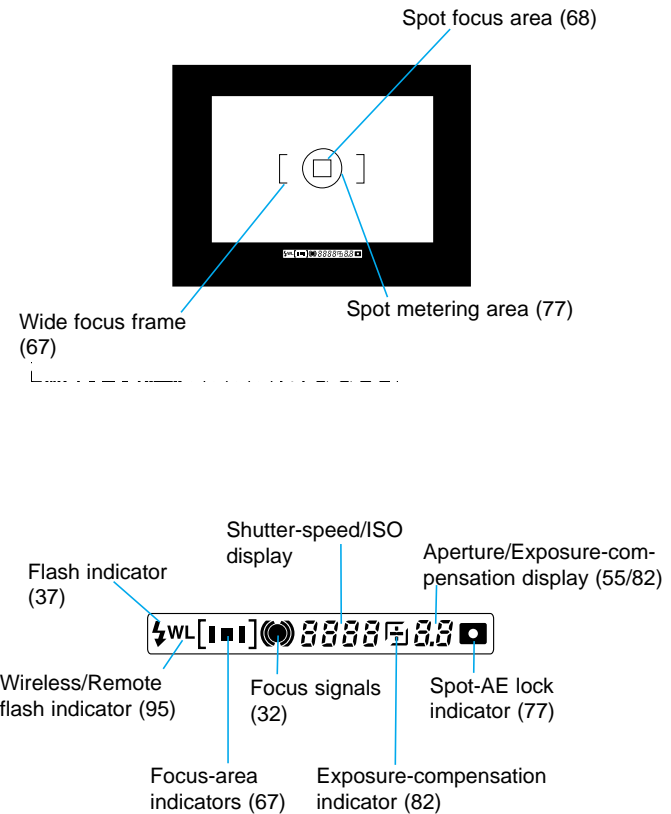



# GETTING STARTED

This section provides the information necessary to prepare the camera for use.

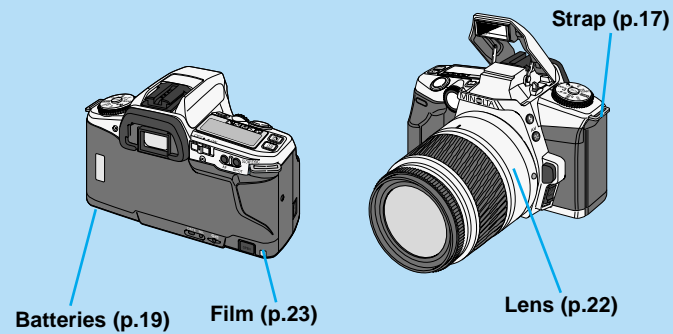

## STRAP

### Attaching the Strap

GETTING STARTED

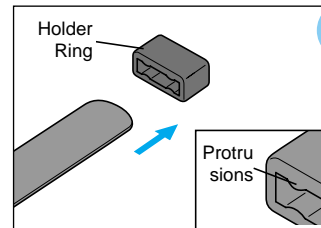

- 1 With the visible protrusions on the inside of the holder ring oriented as shown, pass the tip of the strap through the ring.

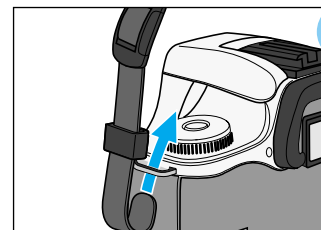

- 2 Pass the tip of the strap through the camera's strap eyelet from below.

- Attach the strap so the tip comes between the strap and the camera.

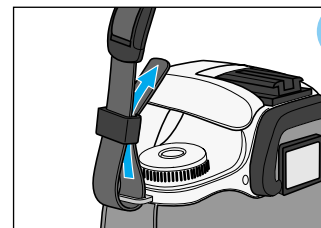

- 3 Pass the tip of the strap through the holder ring.

- Use the following method if the ring is tight for the tip.
  - 1) Fold the strap, and slide the holder ring over the tip.
  - 2) Hold the strap, and slide the holder ring in the direction shown.

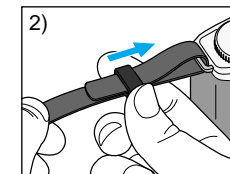
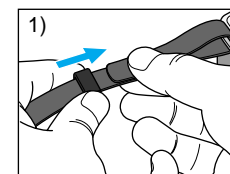

## STRAP

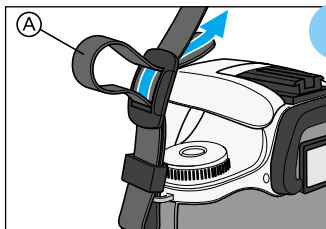

**4** Pass the tip of the strap through the buckle and pull to tighten.

- Leave some slack in the camera strap(A) so the tip may be threaded through the buckle easily.

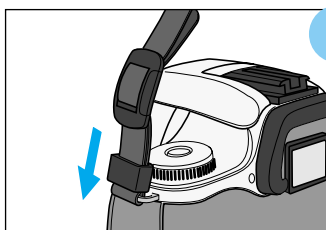

**5** Push the holder ring toward the strap eyelet to secure the strap to the camera.

- Repeat with the other end of the camera strap.

- Take care not to catch the strap when closing the back cover.

## Using the Eyepiece Cap

The eyepiece cap is used to prevent light from entering the camera during time exposures (buLb, p. 79) or when using the self-timer (p. 46). Light entering through the viewfinder can affect the metered exposure.

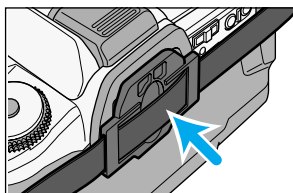

**Firmly press the eyepiece cap of the strap into the eyepiece.**

## BATTERIES

## Installing the Batteries

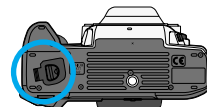

Your camera uses two 3V CR2 lithium batteries to supply power for all camera operations.

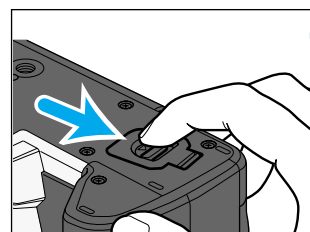

**1** Slide the battery-chamber release as shown, and open the door.

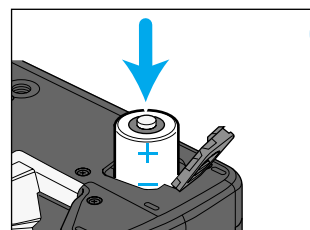

**2** Insert the batteries. Match the positive terminal mark inside the battery chamber-door with the positive end of the batteries.



**3** Close the battery-chamber door and push until it clicks.

- When changing batteries, make sure the main switch is off.
- Setting the camera down with the battery-chamber door open may damage the camera.
- For owners of the quartz-date model, The clock and calendar are powered by the camera's batteries. If the batteries are removed, and the date and time will reset, date imprinting function will be disabled. To store the date and time when changing batteries, see page 21.
- Read "FOR PROPER AND SAFE USE" (p.7) before using batteries.

## BATTERIES

### Battery Condition Indicators

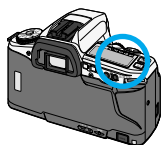

Battery condition indicators shows the level of battery power.

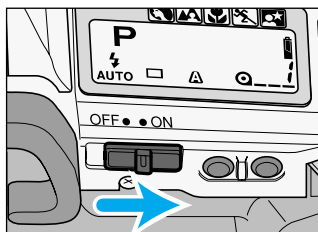

#### Turn the main switch to ON.

- A battery icon appears on the data panel indicating the power status of the batteries.
- For owners of the quartz-date model, the date settings will blink if not set. Set the date settings (p.100) or press the program-reset button to display the power status.

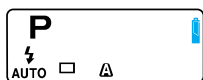

#### **Steady**

- Power is sufficient for all camera operations.

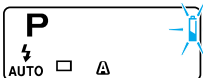

#### **Blinks**

- Power is low. All functions are operational, but the batteries will need to be replaced soon. Flash recycling time may be slow.

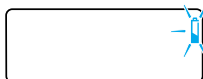

#### **Blinks ( no other displays appear )**

- Power is insufficient for camera operation and the shutter is locked. Replace the batteries.

- If the data panel is blank, the batteries may be dead or installed incorrectly.

- Occasionally, the battery-condition indicator will give a false low-battery-power warning  , even though there is enough power capacity. Turn the main switch on and off a few times to reset the display.

### Changing the Batteries - Quartz-date Model

When the batteries have been removed, the camera's built-in clock will stop. The following procedure stores the current time and date in case the clock and calendar reset when the batteries are removed.

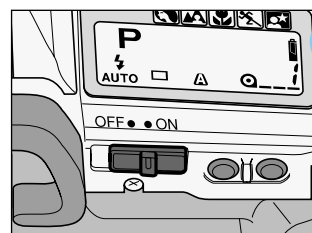

#### 1 Turn the camera on and off.

- The camera stores the current date and time in a memory register each time the camera is turned off or on.

#### 2 Change the batteries as described on page 19. Turn the camera on.

- Either of the following display appears on the data panel.

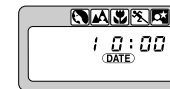

- If normal display appears on the data panel, the clock and calendar did not reset and the camera can be used. Step 3 and 4 are not necessary.

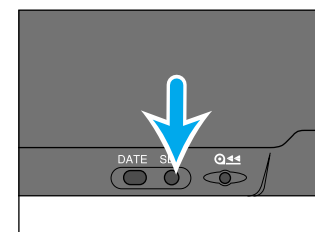
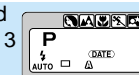

#### 3 Press the select button.

- The stored date and time settings will appear on the display.

#### 4 Reset the clock if necessary.

- Refer to the page 100 for detailed instructions.

## LENS

### Attaching the Lens

This camera uses interchangeable lenses. See page 114 for information on which lenses are compatible with this camera.

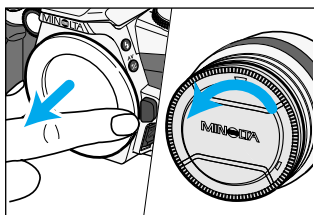

- 1 Remove the body and rear lens caps.

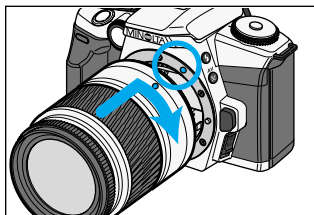

- 2 Align the red mounting index on the lens and camera body. Carefully insert the lens into the mount, then turn it clockwise until it clicks into the locked position.

- Do not insert the lens at an angle.

### Removing the Lens

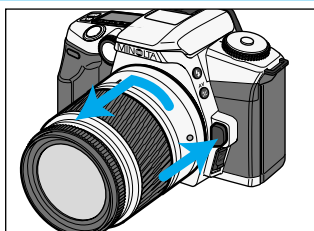

While pressing the lens release, turn the lens counter-clockwise until it stops. Carefully remove the lens.

- Replace the caps on the lens and attach the body cap or another lens on the camera.

- Never force the lens. If it does not fit, check its orientation with the index marks. When removing, make sure the lens release is pressed all the way down.
- Do not touch the inside of the camera, especially the lens contacts and mirror.

22

## FILM

Always load or remove the film under subdued light to reduce the chances of fogging.

### Loading the Film

The camera automatically sets the correct film speed (ISO) with DX-code film.

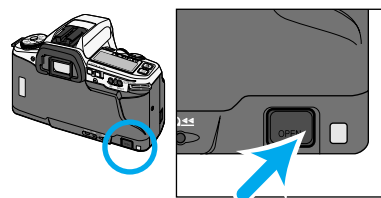
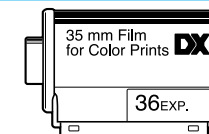

- 1 Press the back-cover release to open the back cover.

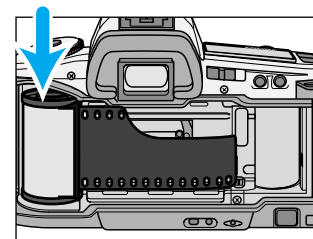

- 2 Insert the film cartridge into the film chamber.

- Do not use Polaroid Instant 35mm film. Winding problems may occur.
- Do not use infrared film in this camera. The camera's frame counter sensor will fog infrared film.
- If non-DX-coded film is used, the camera will use the previous roll's ISO setting. Refer to page 84 to set the film speed manually.
- More than 40 exposures can not be taken on one roll with this camera. When using 72-exposure film, the camera will start to rewind the film after 40 exposures have been made.

Continued on next page

23

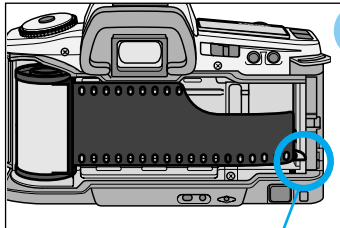

**3 Extend the leader between the guide rails to the index mark.**

- Hold the film cartridge down so that the film lays flat.
- If the film tip extends beyond the index mark, take the cartridge out and rewind the excess film back into the cartridge.

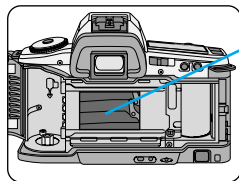
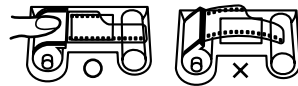
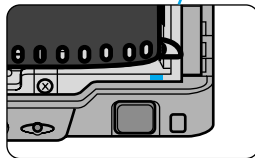

The shutter curtain's precision design makes it extremely sensitive to pressure. Never touch it with your fingers or the film tip.

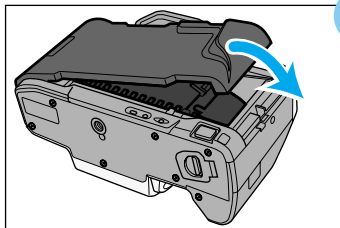

**4 Close the back cover.**

- The camera automatically advances the film to the first frame.
- Take care not to catch the strap when closing the back cover.



**When the film is loaded correctly :**

- 100 appears in the frame counter. The film speed (ISO) is displayed on the data panel for 5 seconds.
- If the film is loaded with the power off, the film speed (ISO) and 100 appears on the data panel for approximately five seconds to indicate successful loading, then the camera shuts down.



**When the film is loaded incorrectly :**

- 100 blinks in the frame counter and the shutter locks. Open the back cover and repeat steps 2 - 4.
- If the film is loaded with the power off, 100 blinks on the data panel before the camera shuts down.

**Film-chamber Lock**

Once the film is loaded, the back-cover release will lock until the film is rewound to prevent the camera from being opened accidentally.

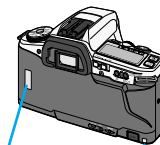

The film window and the film-chamber lock indicator will show if a roll of film is in the camera. Always check these before loading a new film.

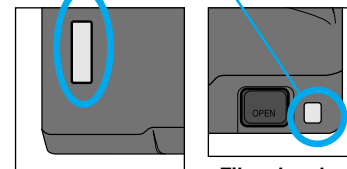

Film Window

Film-chamber lock indicator

- When film is loaded properly, the film chamber lock indicator is red, and the back cover cannot be opened.
- To change a roll of film in the camera, refer to manual rewind on page 26.

## FILM

### Rewinding the Film

After you have exposed the last frame, the camera will automatically rewind the film.



#### 1 Wait until the film is completely rewound.

- The film-chamber lock indicator will appear and the program indicator will blink on the data panel, indicating it is safe to open the back-cover.
- The film-chamber lock indicator is blank after the film is rewound.

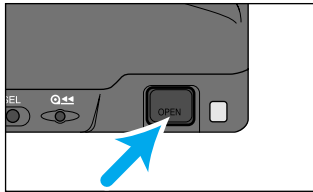

#### 2 Press the back-cover release to open the back cover and remove the film, then close the back cover.

- Do not turn the focusing ring when the film is rewinding.
- Although more pictures than specified on the film package may be taken, the film processor may not print more than the number specified on the film cartridge.

### Manual Rewind

Use manual rewind to rewind the film before the roll is finished.

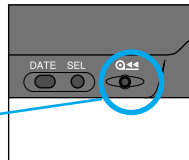
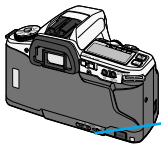

#### Gently press the manual-rewind button using a pen.

- Only use blunt objects. Sharp objects may damage the camera.
- The film-chamber lock indicator will appear and the program indicator will blink on the data panel when the film has rewound.

#### Custom Function Notes

Cust-2: Automatic (1) or manually initiated (2) rewind start (p.106).

Cust-3: Rewind the leader into the cartridge (1) or leave the leader out (2) (p.107).

## FULLY-AUTOMATIC OPERATION

Use full-auto when you are just starting out or when shooting under conditions that would require you to constantly adjust the focus or exposure.

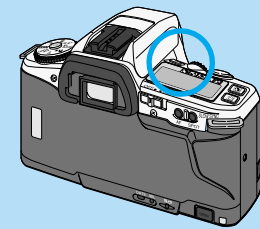

Program-reset button (p.30)

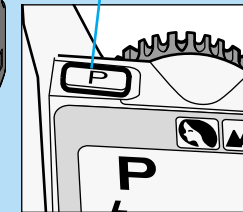

## HANDLING THE CAMERA

### Pressing the Shutter-release Button

Press the shutter-release button partway down to activate the camera's autofocus and auto-exposure systems. Press the shutter-release button all the way down to take the picture. When taking a picture, press the shutter-release button with your index finger gently so not the shake the camera during the exposure.

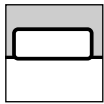

Before pressing

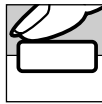

Pressing partway down activates camera systems

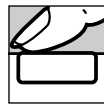

Pressing all the down releases the shutter

### Holding the Camera

Grip the camera firmly with your right hand, while supporting the lens with your left. Keep your elbows at your side and your feet shoulder-width apart to hold the camera steady. Keep the camera strap around your neck or wrist in the event you accidentally drop the camera.

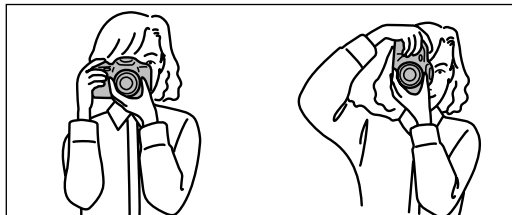

- Lean against a wall or rest your elbows on a solid surface to steady the camera in low-light situations.
- The use of the tripod is recommended when using the camera in low-light situations or with slow shutter speeds or telephoto lenses.

## AUDIO SIGNAL

Audio signal is initially on. The camera will produce an audio tone when :

- **focus is confirmed.**  
2 short beeps  
(Continuous AF (p. 72) does not use audio signals.)
- **during the self-timer countdown.**  
will beep in unison with the self-timer lamp.
- **Remote-control operation\***  
will give one short beep before the shutter releases with the release button.  
With the delayed-release button, the signal will beep rapidly for 1 second, and then sound a long tone just before the shutter releases.

\*Remote-control is sold separately for owners of the quartz-date model.

### Canceling the Audio Signal

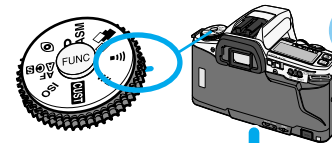

1 Turn the function dial to ).

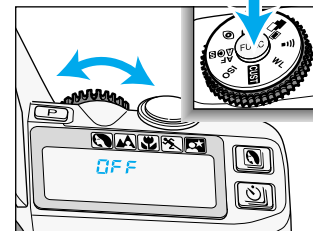

2 While pressing the function button, turn the control dial to .

### Turning the Audio Signal On

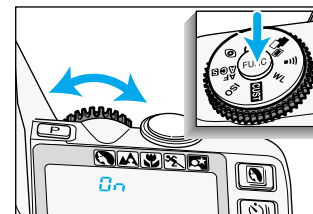

1 Turn the function dial to ).

2 While pressing the function button, turn the control dial until appears on the data panel.

## TAKING PICTURES IN FULL-AUTO

Full-auto is the camera's standard operating mode and is suited for use in almost any situation. When selected, the camera sets the focus and exposure automatically and fires the built-in flash when necessary.



**1** Slide the main switch to ON.

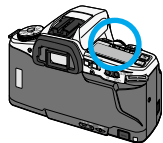
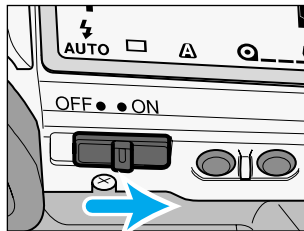

**2** Press the program-reset button **P** to set the camera to full-auto.

- The camera will return to its default settings (p113).

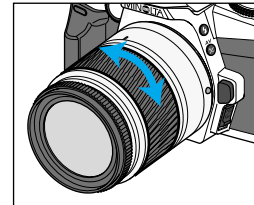
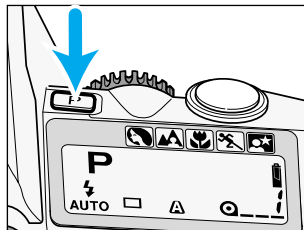

**3** Center your subject in the wide focus frame [ ]. If using a zoom lens, rotate the zooming ring to frame your subject as desired.



Flash signal

- Press the shutter release button partway down to activate the autofocus and exposure systems.
- When  appears in the viewfinder, the flash will fire (p.35).

AUTOMATIC OPERATION

**4** When ● or (●) appears in the viewfinder, press the shutter-release button all the way down to take the picture.

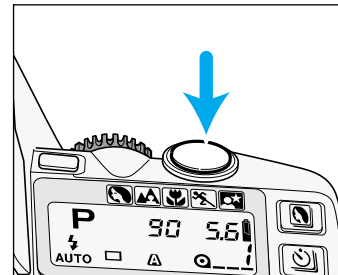

- The audio signal confirms the camera has focused when the shutter-release button is pressed partway down.
- In low-light conditions, the AF illuminator will activate to determine focus distance (p.75).



# FOCUS

## Focus Signals

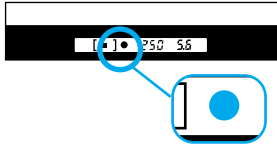

The following signals appear in the viewfinder to indicate the focus status.

- Focusing time can be longer with macro or telephoto lenses. In very dark conditions the camera may require a little more time to ensure accurate focus.

● Steady	Focus is confirmed.
⦿ Steady	Focus is confirmed (Continuous AF).
⦿ Steady	Lens is focusing (Continuous AF). <ul style="list-style-type: none"> <li>The shutter is locked.</li> </ul>
● Blinking	Focus cannot be confirmed. <ul style="list-style-type: none"> <li>The shutter is locked.</li> </ul>

- When focus cannot be confirmed, the subject may be too close or one of the special focus situations on the following page is preventing the system from focusing. Use focus lock (p. 33) or manual focus (p. 74).

### Custom Function Notes

Cust-1: Autofocus has priority (1), shutter-release has priority (2) (p.106).

## Special Focus Situations

The camera may not be able to focus in the situations described below. Use focus lock (p. 33) or manual focus (p.74).

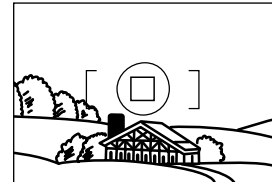

If the subject within the focus frame is very bright, or low in contrast.

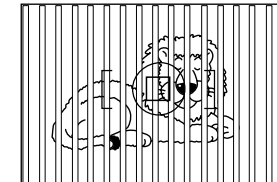

If two subjects at different distances overlap in the focus frame.

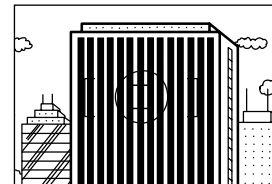

If a subject composed of alternating light and dark lines completely fills the focus frame.

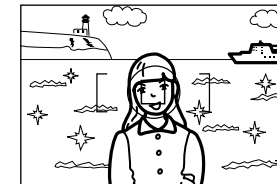

If your subject is near a very bright object or area.

## FOCUS LOCK



The focus-lock function is used when the subject is off-center and outside the focus frame. Focus lock may also be used when a special focusing situation prevents the camera from focusing on the subject.

- Focus lock cannot be used with continuous AF. The spot AF button (p.68) can also be used for focus lock.
- Focus can be locked in continuous AF  (p.72) with the spot AF button.



- 1 Center your subject in the wide focus frame , then press the shutter-release button partway down to lock the focus.**

- When  appears in the viewfinder, the focus is locked.
- Focus lock also sets the exposure settings.



- 2 Continue to hold the shutter-release button partway down while you compose your picture.**



- 3 Press the shutter-release button the rest of the way down to take the picture.**

- Removing your finger off the shutter-release button cancels focus lock.

## USING THE BUILT-IN FLASH



In P-mode, the built-in-flash will pop-up automatically when the shutter-release button is pressed partway down. Once the flash is up, it will fire when necessary.

- The shutter will not release until the flash is charged.
- To turn off the autoflash, select flash cancel .
- Pressing the program-reset button resets the flash to autoflash mode.
- Push down the built-in flash when the camera is not in use.

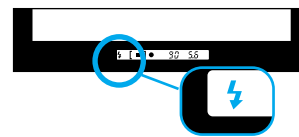
### Flash Signals



Flash signals in the viewfinder indicate the status of the flash.

 Steady	Flash is charged and will fire when the shutter-release button is pressed.
 Blinks	Flash output was sufficient to provides correct exposure.

- When  does not blink after taking the picture, the subject was not within the flash range. Please check the flash range on the next page.

## USING THE BUILT-IN FLASH

### Flash Range

The range of the built-in flash depends on the speed of the film and the selected aperture. Make sure your subject is within the flash range specified in the table below.

	ISO 100	ISO400
f/3.5	1.0 ~ 3.4m / 3.3 ~ 11.2 ft.	1.0 ~ 6.8m / 3.3 ~ 22.3 ft.
f/4.0	1.0 ~ 3.0m / 3.3 ~ 9.8 ft.	1.0 ~ 6.0m / 3.3 ~ 19.7 ft.
f/5.6	1.0 ~ 2.1m / 3.3 ~ 6.9 ft.	1.0 ~ 4.3m / 3.3 ~ 14.1 ft.

- Do not use the built-in flash with focal lengths shorter than 28mm. The built-in flash cannot cover lenses wider than 28mm.
- Make sure you are at least 1m (3.3 ft.) from your subject when using the built-in flash.

### Lens Shadowing



Lens shadowing occurs when the lens or lens hood blocks part of the output from the built-in flash. Lens shadowing appears as a semi-circular shadow area at the bottom (horizontal pictures) or side (vertical pictures) of the image.

- Remove the lens hood before using the built-in flash.
- Lens shadowing may occur with the following lenses at the shorter focal lengths.
  - AF Zoom 28-70mm f/2.8G
  - AF Zoom 17-35mm f/3.5G
  - AF Zoom 28-135mm f/4.0-4.5
  - AF Zoom 28-85mm f/3.5-4.5
- The built-in flash can not be used with the following lenses:
  - AF 300mm f/2.8 (APO tele)
  - AF 600mm f/4.0 (APO tele)

### Fill Flash

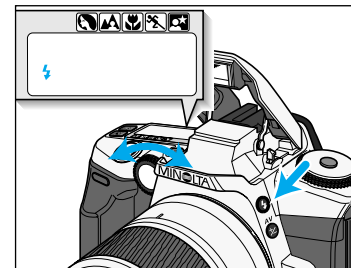
Use the fill flash when taking pictures under fluorescent lighting or to eliminate harsh shadows. When set, the flash will fire every time a picture is taken.





While pressing the flash-mode button , turn the control dial until  appears on the data panel.

- To return to autoflash mode, repeat the step above until  appears.
- A shortcut for single shots with fill flash in autoflash mode can be made. Hold the flash-mode button down when pressing the shutter-release button to fire the fill flash.

### Flash Cancel

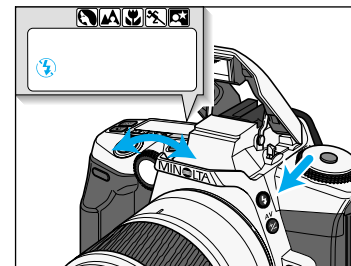
Use the flash cancel when photographing twilight scenes or to capture the ambiance of the existing light.



While pressing the flash-mode button , turn the control dial until  appears on the data panel.

- The flash will not fire even if the built-in flash pops-up.

- To return to autoflash mode, repeat the step above until  appears.
- The shutter speeds will be slow in low-light situations. The use of a tripod is recommended.

#### Custom Function Notes

Cust-8: Autoflash will be set in P mode (1), flash cancel will be set in PA mode (2) or Ps mode (3) (p.109).

## USING THE BUILT-IN FLASH

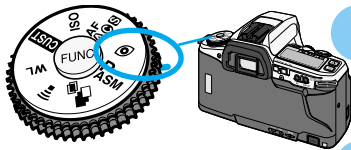

### Red-Eye Reduction

When using flash in low-light conditions, light reflecting from the retina of your subject's eyes may produce the effect known as red-eye. Use the built-in flash's red-eye reduction mode to produce natural looking photographs.

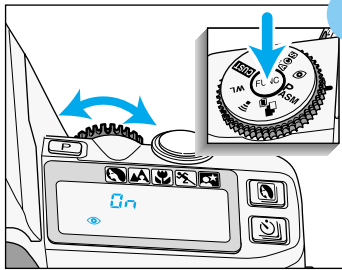

**1** Turn the function dial to .







**2** While pressing the function button, turn the control dial until  and  appear on the data panel.

- When you release the button, the display will return to normal and only  will remain on the data panel.
- Warn your subject that the flash will fire a few short flash bursts just before the picture is taken.

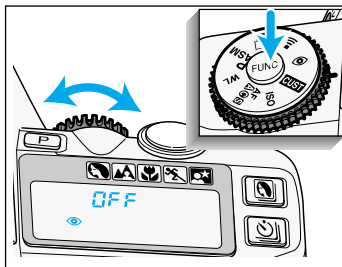
- Red-eye reduction cannot be used with the Wireless/Remote flash mode (p.95).

### Canceling Red-eye Reduction



Turn the function dial to . While pressing the function button, turn the control dial until  and  appear on the data panel.

38

## SUBJECT PROGRAM / DRIVE MODES

Now that you are comfortable with the operation of the camera, take more control of the creative process by telling the camera what kind of pictures you want to take.

The subject-program modes optimize camera settings for specific situations. This section also lets you explore the use of the drive-mode button. Drive modes control the advance of the film.

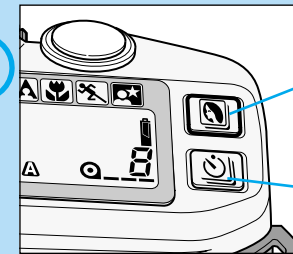
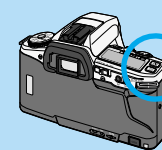

Subject-program button

Drive-mode button

39



## SUBJECT-PROGRAM SELECTION

### Portrait

Portraits have the greatest impact when a shallow depth-of-field\* is used to separate the subject from the background. In portrait mode, the necessary settings are made automatically, leaving you free to capture the perfect expression.

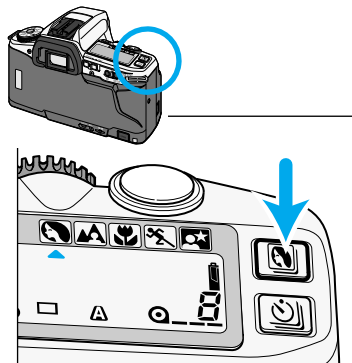
\*Depth-of-field is the area in front of and behind the subject that appears sharp (p. 52).







Press the subject-program button  until the subject-program indicator  points to .

- For best results use the telephoto setting of the lens.
- Use fill flash (p. 37) when your subject is backlit or has strong shadows across the face.
- Focus on your subject's eyes and be ready to capture the perfect expression.
- Use night portrait mode (p.44) with subjects at night.

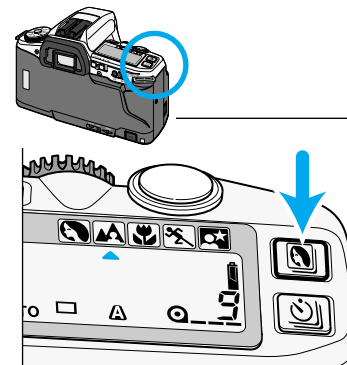
### Landscape

Landscape photography requires a large depth-of-field to make sure the subject and background are in focus. In landscape mode, the camera is set to obtain the greatest depth-of-field possible, while maintaining a shutter speed fast enough to prevent blurring from camera shake.



Press the subject-program button  until the subject-program indicator  points to .

- For best results zoom to a wide angle setting or use a wide angle lens. Include a foreground subject or detail to create a feeling of depth in the picture.
- Use flash when a subject in the foreground is backlit or has strong shadows across the face. Without a foreground subject, the flash will have no effect on the landscape. Please see page 36 for the camera's flash range.
- For best results, use a tripod.
- Use night portrait mode (p.44) with subjects or scenery at night.



## SUBJECT-PROGRAM SELECTION

### Close-up

Use close-up mode when photographing small objects like flowers or jewelry. In close-up mode, the camera automatically sets the best possible aperture and shutter speed for close-up photography.

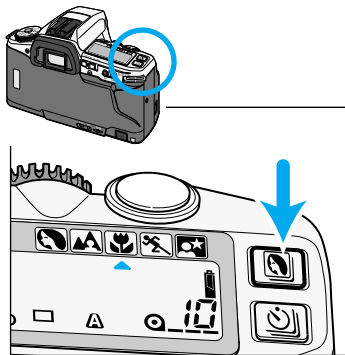
- Focusing time can be longer with macro lenses.



Press the subject-program button  until the subject-program indicator  points to



- Use a tripod to reduce camera shake.



- For best results in close-up photography use a macro lens or a macro capable zoom lens.
- Do not use the built-in flash if your subject is closer than 1.0m (3.3 ft.). The flash exposure will be overexposed. See flash range, p. 36.
- At close distances, the lens or lens hood may block the flash, creating a shadow at the bottom of your image (lens shadowing, p. 36). The use of an accessory flash is recommended.
- Make sure the subject is not closer than the minimum focusing distance of lens. Refer to the owner's manual of your lens.

42

### Sports

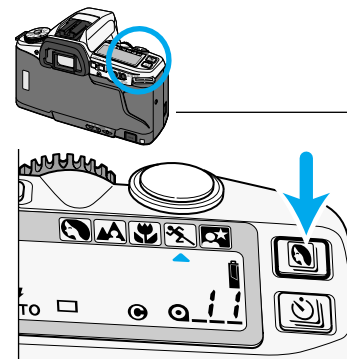
Fast shutter speeds are needed to stop action. In sports mode, the camera will set the fastest possible shutter speed and continually adjust the focus to track fast-moving subjects.



Press the subject-program button  until the subject-program indicator  points to



- The camera continues to focus as long as the shutter-release button is pressed partway down. Continuous AF  (p.72) is used.

- The built-in flash is only effective when your subject is within the flash range. When the subject is not within the range, use flash cancel (p.37).
- The use of fast film is recommended.
- Mount the camera on a tripod or monopod when using telephoto lenses.



43

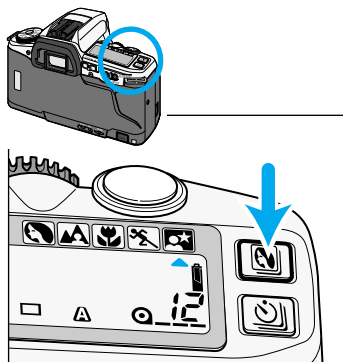

## SUBJECT-PROGRAM SELECTION

### Night Portrait

Night portraits balance the camera's flash exposure with the background exposure. In night portrait mode, the camera controls the aperture and shutter speed, allowing the background to appear in the photograph.



Press the subject-program button  until the subject-program indicator  points to .



- Set the flash to fill flash  or fill flash with red-eye reduction  when using night portrait mode. See pages 37 and 38.

- The use of fast film is recommended.
- Warn your subject not to move while the picture is taken. The shutter remains open to capture the background.
- The shutter speed may be slow. Use a tripod to reduce camera shake.

### Photographing Night Scenes

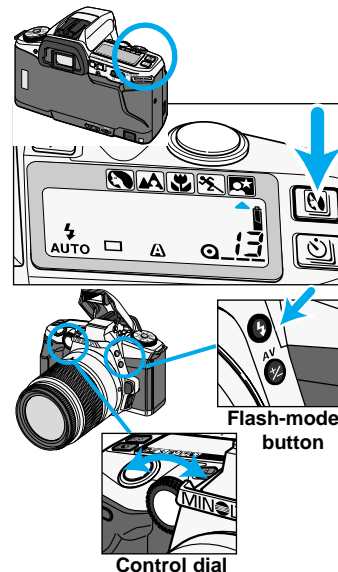
Cancel the flash in night portrait mode to photograph night scenes. The longer shutter speeds set in night portrait mode let you capture beautiful photographs of twilight scenes and night skylines.



**1** Press the subject-program button  until the subject-program indicator  points to .

**2** While pressing the flash-mode button, turn the control dial until  appears on the data panel.

- Use a tripod to reduce camera shake.



- The use of fast film is recommended.
- Dark night scenes may prevent the AF system from focusing, use focus lock (p34) or manual focus (p74).
- Night scenes tend to be better at twilight rather than in the darkness of night. The faint light in the early evening sky adds detail to the shadows of the scene.
- The shutter speed may be slow. Use a tripod to reduce camera shake.

## DRIVE MODES

### Self-timer

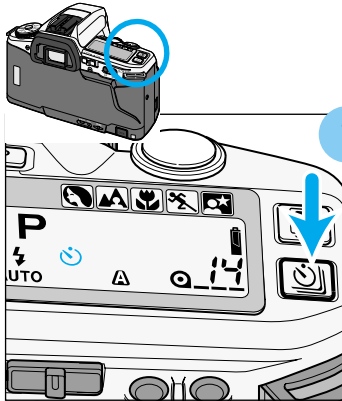
The self-timer delays the release of the shutter for approximately 10 seconds after the shutter-release button is pressed.



- 1** Place the camera on a tripod. Press the drive-mode button  until  appears on the data panel.

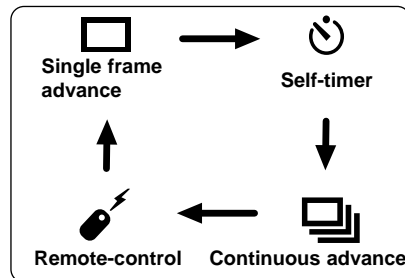

- 2** Center your subject in the focus frame.

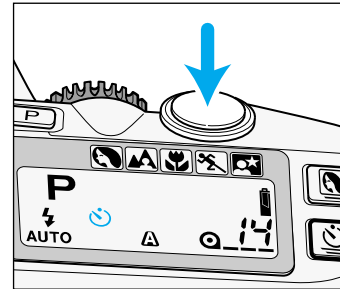

- 3** Press the shutter-release button partway down to lock the focus.

- For off-center subjects, use focus lock (p. 34).

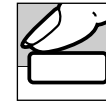

- 4** Press the shutter-release button all the way down to start the timer.

- The self-timer lamp on the front of the camera will blink, then glow just before the shutter releases.
- The audio signal beeps in unison with the self-timer lamp (p.29).

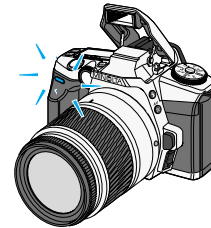

- Do not press the shutter-release button while standing in front of the camera. The focus and exposure is set when the shutter-release button is pressed.
- The self-timer is cancelled after the shutter is released.
- To cancel the self-timer countdown, press the drive-mode button or slide the main switch to OFF before the shutter releases.
- Attach the eyepiece cap if there is a bright light source behind the camera (p.18).





## DRIVE MODES

### Continuous Advance

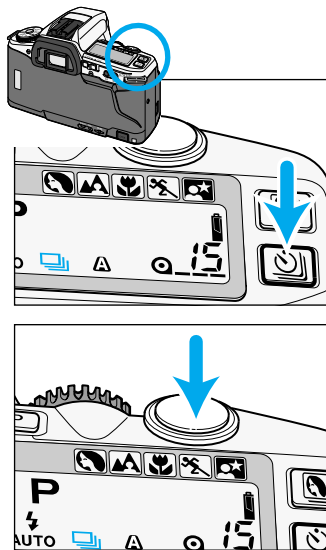

In this mode, the camera continues to release the shutter and advance the film as long as the shutter-release button is held down.

- The camera takes 1.7 frames per second, when setting the shutter-speed to above 1/250 second with flash cancel (p.37), single-shot autofocus or manual focus (p.74), and new batteries.



**1** Press the drive-mode button  until  appears on the data panel.

**2** Press and hold the shutter-release button to begin taking a series of pictures.

- When taking flash pictures, the shutter will release only when the built-in flash finishes charging between exposures.
- With accessory flashes, the shutter will continue to release even if the flash is charging.
- With continuous AF  and moving subjects, the shutter will release only when the camera has focused on the subject between exposures.
- To return to single frame mode, press the drive-mode button until  appears on the data panel.

- AF zoom xi and power zoom lenses cannot be zoomed when taking pictures with continuous Advance.

#### Custom Function Notes

Cust-1: Autofocus has priority (1), the shutter-release has priority (2) (p.106).

### For Owner's of the Remote-control Function

The camera can be operated up to 5m (16.4 ft.) away with the IR Remote Control RC-3 (sold separately).\*

\*The quartz-date model is equipped with the remote-control function.

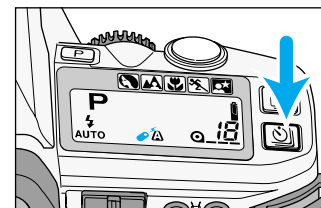

**1** Place the camera on a tripod. Press the drive-mode button  until  appears on the data panel.

**2** Arrange the camera and subject position to compose your picture.

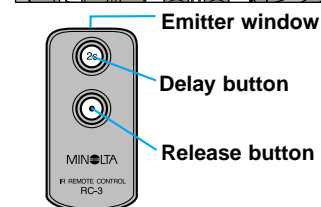

**3** Point the emitter window toward the remote-control receiver and press the release or the delay button.

- If the release button is pressed, the lamp on the front of the camera will blink once before the shutter releases. The audio signal will produce 1 short beep.
- If the delay button is pressed, the lamp on the front of the camera will blink for two seconds before the shutter releases. The audio signal will beep in unison with the lamp.

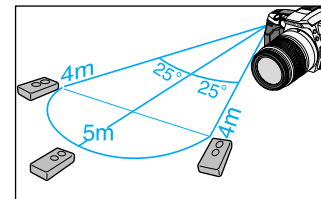

- The remote control may not work under fluorescent lighting or in backlit situations.
- If the built-in flash pops up when the release button on remote control is pressed, wait a few seconds for the flash to charge before pressing the release button again.
- To save power, remote-control mode is canceled if the remote control is not operated for more than 5 minutes.
- Attach the eyepiece cap if there is a bright light source behind the camera.

## DRIVE MODES

### Focus Lock in Remote Control Mode

When your subject is not centered in the focus frame, use manual focus or focus lock.

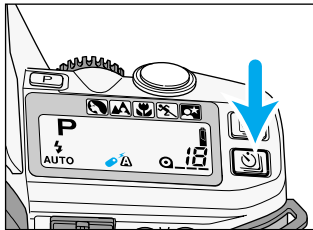

**1** Set the camera to the remote-control mode.



**2** Center your subject in the focus frame, then press the shutter-release button partway down until ● appears in the viewfinder.



**3** Lift your finger from the shutter-release button.

- Focus and exposure is set for the picture.
- The shutter speed and aperture will be displayed on the data panel.



**4** Recompose the picture.



**5** Point the remote toward the front of the camera and press the release or delay button.

# CREATIVE EXPOSURE MODES

In this section you take full creative control of your camera. Depending on the selected exposure mode, you will control the aperture, shutter speed, or both when capturing your image.

In the previous sections, only the program (P) exposure mode was explored. Here you will learn to use the aperture priority (A), shutter priority (S), and manual (M) exposure modes. Select A mode to control the depth-of-field in your images. Set S mode to control the way moving subjects appear in your images. Set M mode when you want full control over the exposure.

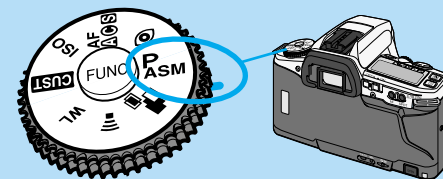

## APERTURE CONTROL

The size of the aperture (lens opening) determines the depth-of-field of the final image as well as the intensity of the light falling on the film. Depth-of-field is the range in front of and behind the subject that appears sharp in the final image. Depth of field increases as the focal length decreases. The wide angle position of the lens will have a greater depth of field at a given aperture than at the telephoto position.



Large ←  $f/3.5$   $f/4$   $f/5.6$   $f/8$   $f/11$   $f/16$  → Small

**Large Aperture**  
(small f-number)

Range in focus is narrower.

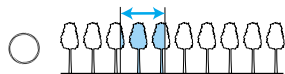

Large apertures (small f-numbers) limit the depth-of-field to a narrow range in front of and behind the point of focus. Set a larger aperture when photographing portraits to make your subject stand out from the background.

**Small Aperture**  
(large f-number)

Range in focus is deeper.

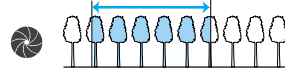

Small apertures (large f-numbers) provide greater depth-of-field. Set a small aperture when photographing landscapes to ensure your entire scene is sharp.

- Usable apertures will depend on the aperture range of the lens you are using.

52

## SHUTTER CONTROL

In addition to controlling the duration of the exposure, shutter speeds determine how moving subjects will appear in the final image. Use a fast shutter speed to stop the motion of your subject, use a slow shutter speed to blur the motion.



Slow ←  $30s$   $6s$   $1s$   $1/8s$   $1/45s$   $1/125s$   $1/250s$   $1/2000s$  → Fast

**Slow Shutter Speed**

Slow shutter speeds will make a moving subject appear to flow, creating a feeling of motion.

**Fast Shutter Speed**

Fast shutter speeds can stop the action and also help prevent blurring caused by camera movement during exposure, known as camera shake.

CREATIVE EXPOSURE

53

## EXPOSURE MODES

Four exposure modes are available on this camera. Select the best exposure for your subject.

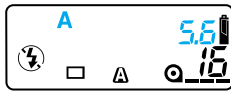

### A mode (Aperture Priority) (p.55)

In A mode, you select the aperture and the camera automatically sets the shutter speed required for proper exposure. Set the camera to A mode when you want to control the depth-of-field in the image.

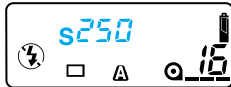

### S mode (Shutter Priority) (p.58)

In S mode, you select the shutter speed and the camera automatically sets the aperture for the proper exposure. Use S mode when you want to control the blur caused by subject movement or stop the motion of your subject.

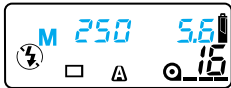

### M mode (Manual Exposure) (p.60)

M mode gives you full control over the exposure by allowing you to set both the shutter speed and aperture. The camera's exposure-compensation indicator displays if the set exposure is more (+) or less (-) than the exposure determined by the camera's metering system.

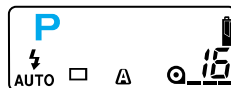

### P mode (Programmed AE) (p.63)

Select P mode when you want to give your full attention to your subject and composition by letting the camera control both the shutter speeds and aperture. The P mode software analyzes the subject's size, motion, and distance as well as the focal length of the lens, then controls the shutter speed and aperture to correctly expose the scene.

## A MODE - APERTURE PRIORITY

In A mode, you select the aperture and the camera automatically sets the shutter speed required for proper exposure. Set the camera to A mode when you want to control the depth-of-field in the image.

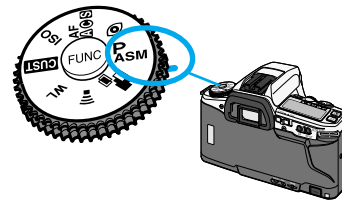

- 1 Turn the function dial to  $P_{ASM}$ .

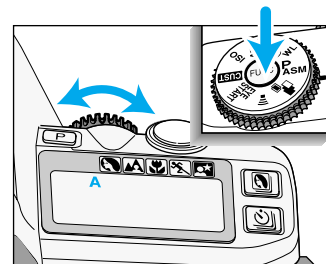

- 2 While pressing the function button, turn the control dial until A appears on the data panel.

CREATIVE  
EXPOSURE

## A MODE - APERTURE PRIORITY

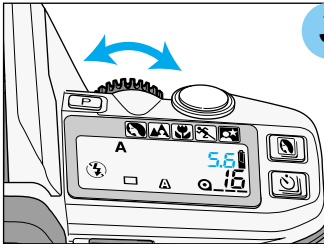

### 3 Release the function button. Turn the control dial to select the aperture.

- If 2000 or 30" blinks on the data panel, the aperture setting is beyond the camera's shutter speed range. Turn the control dial until the shutter-speed display stops blinking.



- To return to P mode, repeat step 1 and 2 until P appears on the data panel.
- To return to P mode and fully-automatic operation, press the program-reset button.(p. 30)

56

## Flash with A Mode

In A mode, flash will not fire automatically. When you want to use flash, pop-up the built-in flash or attach an accessory flash.

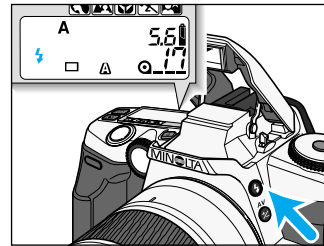

### Press the flash-mode button to pop-up the built-in flash.

- ⚡ will appear on the data panel.
- The shutter speed will be set to 1/90 or slower.
- If 90 blinks in the viewfinder and on the data panel, the light level is too bright for the selected aperture. Turn the control dial to change the aperture until the blinking stops or cancel the flash.

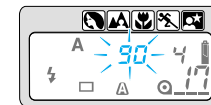

CREATIVE EXPOSURE

- A smaller aperture (larger f-number) will result in a shorter flash range. Refer to flash range (p.36) to determine the range of the built-in flash at the selected aperture. The use of very small apertures (large f numbers) is not recommended.
- The ⚡ will blink in the viewfinder after the picture is taken to confirm the flash exposure.

## Canceling the Flash

Push the built-in flash down or turn the accessory flash off.

- ⚡ will be displayed on the data panel.

57

## S MODE – SHUTTER PRIORITY

In S mode, you select the shutter speed and the camera automatically sets the aperture required for proper exposure. Use S mode when you want to control the blur caused by subject movement or the stop the motion of the subject.

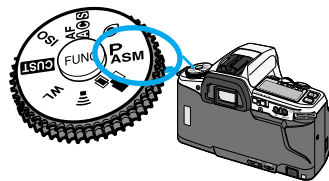

**1** Turn the function dial to  $P_{ASM}$ .

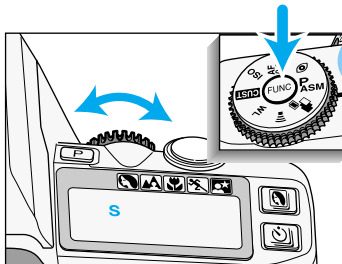

**2** While pressing the function button, turn the control dial until S appears on the data panel.

**3** Release the function button. Turn the control dial to select the shutter speed.

- The shutter speed range is from 1/2000 to 30 seconds.



Fractions of a second are displayed without a numerator. The number 90 displayed stands for 1/90th of a second.



" indicates full seconds. 2" is two seconds.



If the aperture display blinks, the shutter speed is outside the aperture range of the lens. Turn the control dial until the blinking stops.

### Flash with S Mode

In S mode, the flash will not fire automatically. When you want to use the flash, pop-up the built-in flash or attach an accessory flash.

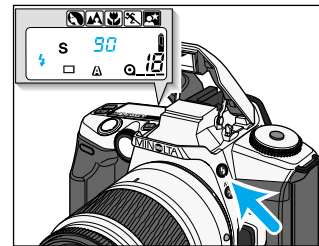

**1** Press the flash-mode button  $\text{⏏}$  to pop-up the built-in flash.

- $\text{⏏}$  will appear on the data panel.

**2** Turn the control dial to select the shutter speed.

- The maximum shutter speed is 1/90 sec when using flash.
- The camera automatically sets the aperture for the selected shutter speed.
- With larger aperture numbers (smaller lens opening), the subject will be out of flash range. The use of smaller aperture numbers (larger lens opening) is recommended. See the flash range (p. 36).

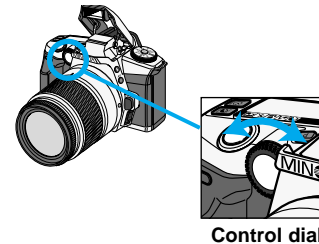

Control dial

CREATIVE EXPOSURE

### Canceling the Flash

Push the built-in flash down or turn the accessory flash off.

- $\text{⏏}$  will be displayed on the data panel.

## M MODE – MANUAL

M mode gives you full control over exposure. The exposure-compensation indicator displays the difference between your shutter speed and aperture settings and the exposure determined by the camera's metering system.

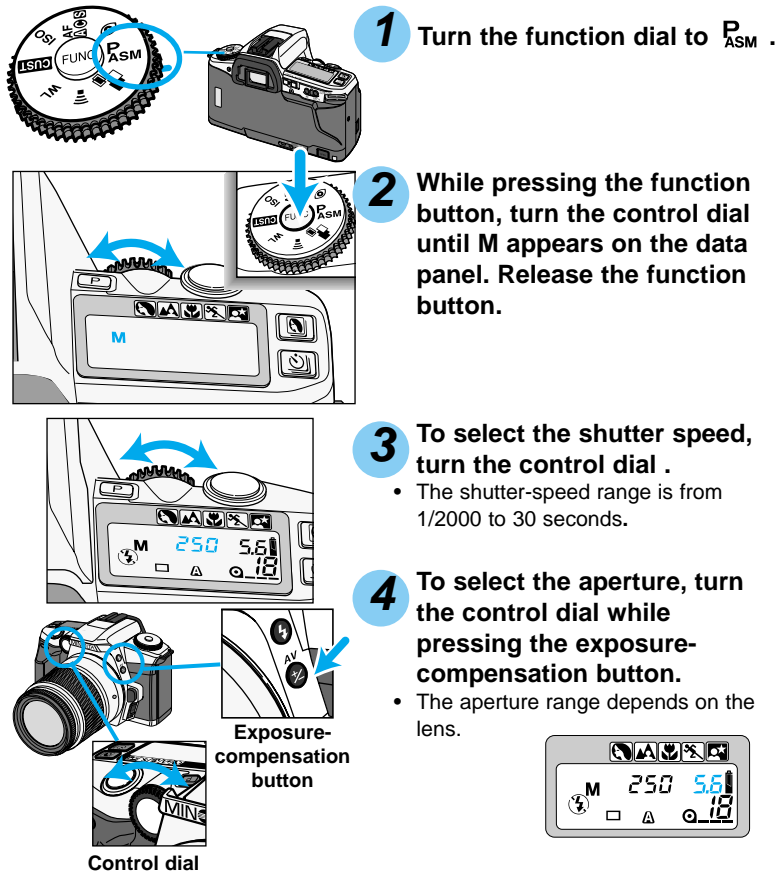

60

### Metering in Manual Mode

In M mode, the exposure-compensation indicator in the viewfinder and on the data panel indicates if the set exposure is greater or less than exposure determined by the camera's metering system.

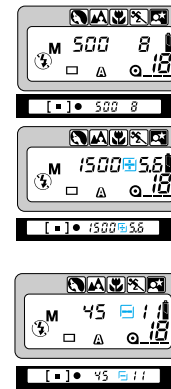

If an exposure-compensation indicator does not appear, your settings agree with the exposure determined by the camera.

 The exposure will overexpose your subject.

 The exposure will underexpose your subject.

CREATIVE  
EXPOSURE

- Any changes with exposure-compensation is canceled temporarily in M mode. If exposure compensation was set before switching to M mode, it will be reapplied when the exposure mode is changed back to another mode.

Continued on next page

61

## M-MODE – MANUAL

### Flash with M mode

In M mode, the flash will not fire automatically. When you want to use the flash, pop-up the built-in flash or attach an accessory flash.

- The camera's automatic flash metering system will ensure proper exposure.

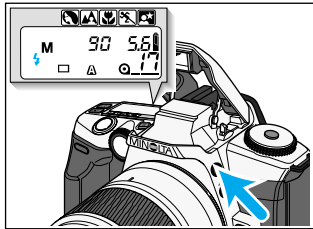

- 1 Press the flash-mode button  to pop-up the built-in flash.

-  will appear on the data panel.

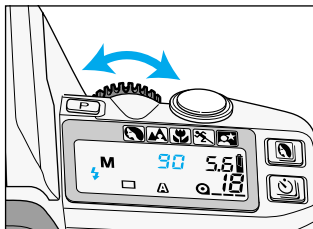

- 2 To select the shutter speed, turn the control dial.

- The maximum shutter speed is 1/90 sec when using flash. The shutter speeds slower than 1/90 can be used

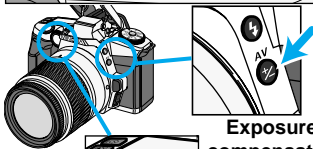

- 3 To select the aperture, press the exposure-compensation button while turning the control dial .

- Refer to the flash range on page 36 to determine the aperture setting.

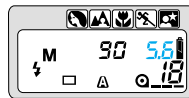

### Canceling the Flash

Push the built-in flash down or turn the accessory flash off.

-  will be displayed on the data panel.

## P MODE

Select P mode when you want to give your full attention to your subject and composition by letting the camera control both the shutter speeds and aperture. The P mode software analyzes the subject's size, motion, and distance as well as the focal length of the lens, then controls the shutter speed and aperture to correctly expose the scene.

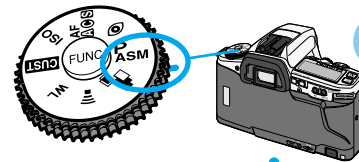

- 1 Turn the function dial to  $P_{ASM}$  .

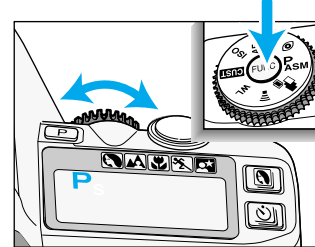

- 2 While pressing the function button, turn the control dial until P appears on the data panel.

### PA Mode

The aperture can be changed in P mode with the Custom 8 -2 setting.(p.109).

- 1 Set the camera to custom 8-2. See page 105 for instructions.

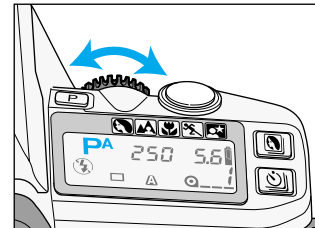

- 2 Press the shutter-release button partway down to display the shutter speed and aperture value. Turn the control dial to change the aperture.

- The shutter speed is automatically adjusted to ensure correct exposure.

Continued on next page



## P MODE

### PS Mode

The shutter speed can be changed in P mode with the Custom 8 - 3 setting.(p.109).

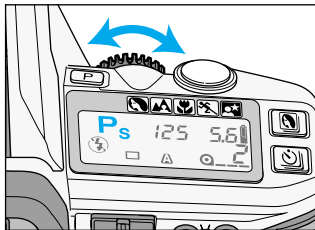

**1** Set the camera to custom 8-3. See page 105 for instructions.

**2** Press the shutter-release button partway down to display the shutter speed and aperture value. Turn the control dial to change the shutter speeds.

- The aperture is automatically adjusted to ensure correct exposure.

- The built-in flash and accessory flashes cannot be used with PA or Ps modes. PA and Ps modes are canceled when the built-in flash is up or an accessory flash is on. The PA and Ps custom settings are still active and can be used when the built-in flash or accessory flash is turned off.
- To turn off the PA/Ps function, change the custom setting to 8-1. Turning the function dial to other modes, or popping up the built-in flash will temporarily cancel the PA/Ps mode.
- When an operation is not made for five seconds, the aperture display (Ps) or the shutter speed display (PA) will go blank on the data panel. A few seconds later, the S/A on the data panel will turn off; the camera returns to P mode. PA/Ps can be activated again by simply pressing the shutter-release button partway down to display the shutter speed and aperture display and then turn the control dial to reactivate the PA/Ps mode.

## EXPOSURE WARNINGS

Indicators will blink in the viewfinder or data panel when the level of available light is beyond the camera's control.

MODE	DISPLAY	CAUSE	ACTION
P A S M		The light level is beyond the camera's metering range.*	<b>Bright Light</b> Use slower speed film, a neutral density (ND) filter, or reduce the light level of your surroundings.
P		The required exposure is beyond the shutter-speed and aperture range.*	<b>Low Light</b> Use higher speed film or a flash.
A/PA		The required exposure is beyond the shutter-speed range.	Select a larger or smaller aperture until the display stops blinking.
S/PS		The required exposure is beyond the aperture range of the lens.	Select a faster or slower shutter speed until the display stops blinking.

\* The warnings may appear with subject programs.

# DETAILED OPERATION

In this section you can move on to the detailed operation to expand your expertise. Read those pages pertaining to the areas of your interest and need.



Taking Time Exposures (p.79)



Multiple Exposures (p.88)

## FOCUS AREA

### Wide Focus Area

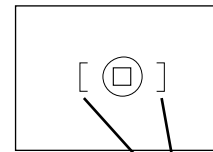

Wide focus frame

Wide focus area uses the camera's three focus sensors to automatically focus on your subject. The wide focus area provides greater framing flexibility and makes it easier for the camera to focus on moving subjects. Wide focus area is the camera's standard focus mode.

The camera determines which sensor is focusing on your subject and sets the focus accordingly.

- The focus areas are not visible in the viewfinder frame.

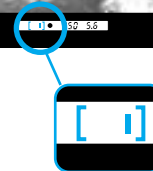
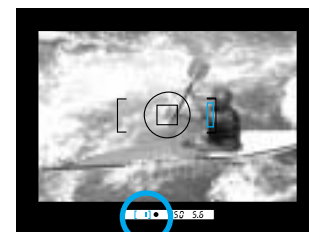
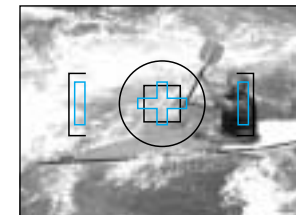

Focus area indicator

- The focus area indicator in the viewfinder tells you which sensor the camera is using.

DETAILED OPERATION

## FOCUS AREA

### Spot Focus Area

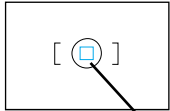

Spot focus area

By simply pressing the spot AF button, the center spot focus area is selected. The focus and exposure settings will be made with the center spot focus area.

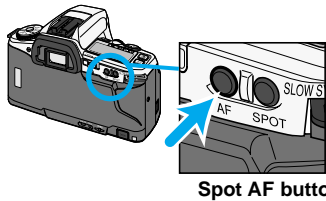

Spot AF button

**1** Place your subject inside the spot focus area.

**2** Press and hold the spot AF button.

- The spot focus area in the viewfinder will glow for a second after focus is confirmed.
- [ ■ ] will appear in the viewfinder, indicating the center focus sensor is being used.
- Focus and exposure remain locked until the spot focus button is released.



**3** While holding the spot AF button, press the shutter-release button all the way down to take the picture.

- When you release the spot AF button, the wide focus frame will be displayed.

### Local Focus Areas

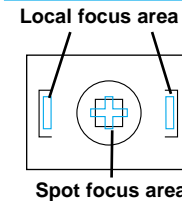

Local focus area

Spot focus area

The spot focus area and the two local focus areas can be individually selected. Use the local focus areas with off-center subjects when the camera is fixed to a tripod.

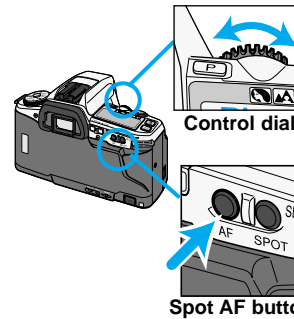

Control dial

Spot AF button

**1** While holding the spot AF button, turn the control dial to select a local focus area.

- The selected local focus area is also indicated by the focus area indicator.

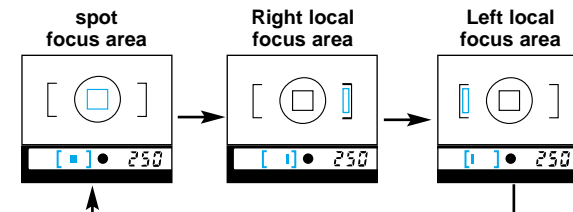
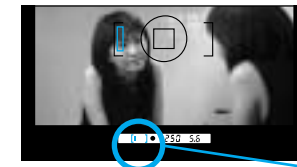

DETAILED OPERATION

**2** While holding the spot AF button, press the shutter-release button all the way down to take the picture.

- If the spot AF button is released, selected local focus area is cancelled and the wide focus area is activated.

## FOCUS AREA

### Focus Area Selection controls

With the focus-area custom function (Custom 9, p.109), how the focus area are selected can be changed.

#### Custom 9 - (1) Select spot focus area

While pressing the spot AF button, the spot focus area is activated. Local focus areas are selected with the control dial while pressing the spot AF button. When the spot AF button is released, the wide focus area is active.

#### Custom 9 - (2) Select focus area.

Wide focus area, spot focus area and local focus areas set with the control dial while pressing the spot AF button. The focus area remains selected even after releasing the spot AF button.

- The sequence when turning the dial clockwise:

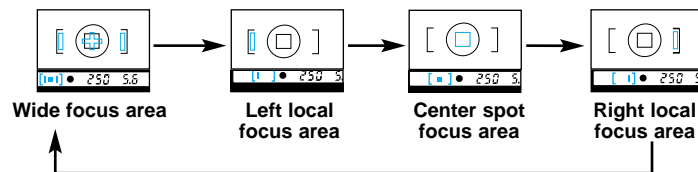

#### Custom 9 - (3)

**Switch between the wide focus frame and the spot focus area.**

Every time the spot AF button is pressed, the camera switches between the spot focus area and wide focus frame. The following displays appears on the data panel and in the viewfinder.

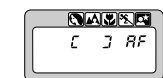

Wide focus area



Spot focus area

- When the RF 500mm lens or the AF Power Zoom 35-80mm lens is attached, only the center local focus area can be selected.

## FOCUS MODES

Your camera has four focus modes:



Automatic AF

Continuous AF

Single-shot AF

Manual Focus

- All the autofocus modes work with the exposure modes: P A S M.
- The subject programs use automatic AF, except for sports mode, which uses continuous AF.

### Automatic AF

Designed to work well in most situations, automatic AF is suited to events that have both moving and static subjects. When the subject is moving, continuous AF  is used; when static, single-shot AF is employed.

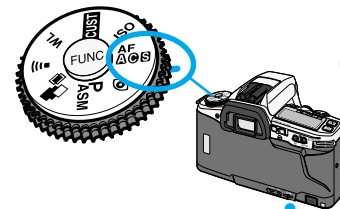

1 Turn the function dial to .

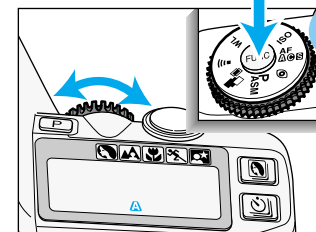

2 While pressing the function button, turn the control dial until  appears on the data panel.

## FOCUS MODES

### Continuous AF

Use continuous AF  when shooting sporting events or when the subject is in constant motion.

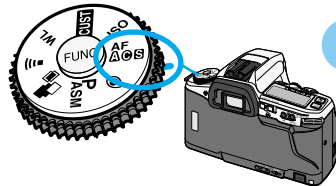

1 Turn the function dial to .

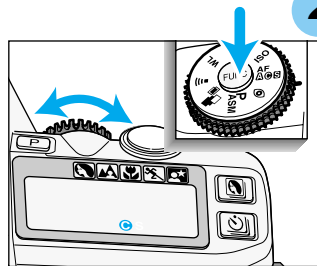

2 While pressing the function button, turn the control dial until  appears on the data panel.

- When taking pictures, the camera continues to focus while the shutter-release button is pressed partway down. Focus lock cannot be used with continuous AF.
- Focus can be locked with the spot AF button in continuous AF.
- Continuous AF  does not use audio signals to indicate focus.

### Single-Shot AF

Use single-shot AF when photographing static subjects.

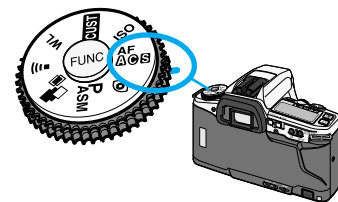

1 Turn the function dial to .

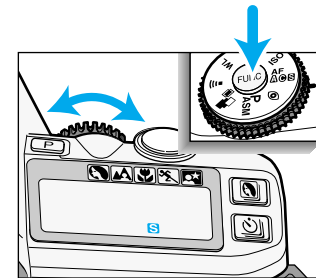

2 While pressing the function button, turn the control dial until  appears on the data panel.

- Focus lock (p.34) can be used with single-shot AF.

## FOCUS MODES

### Manual Focus **MF**

The autofocus system can be used to monitor focus and indicate when a subject in the focus frame is in focus. The lens can be focused manually when autofocus and focus lock is not possible.

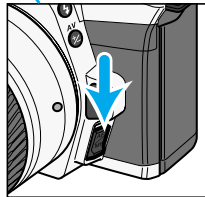
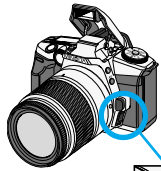

Focus-mode switch

- 1 Hold the focus-mode switch down and release.
  - **MF** will appear on the data panel.

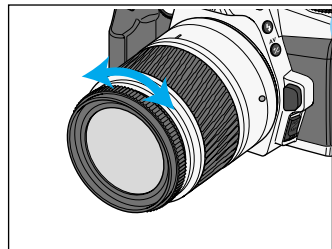
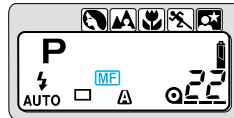

- 2 Turn the focusing ring until your subject appears sharp.
  - While pressing the shutter-release button partway down, ● appears in the viewfinder when the subject in the focus frame is in focus.
  - To return to the autofocus mode, push the focus-mode switch down a second time.

- In manual focus mode with any lens except the 'D' series lenses, the camera switches to center-weighted metering. The metered exposure may be different between autofocus and manual focus.

## AF ILLUMINATOR

The built-in flash is used as an AF Illuminator. When the scene is too dark for the camera to focus, the built-in flash fires a few short bursts when the shutter-release button is pressed partway down to provide the light necessary for the camera to focus.

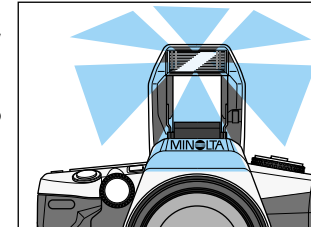

- Pressing the spot AF button can also activate the AF illuminator.
- The range of the AF Illuminator is approximately 1 to 5 m (3.3 to 16.4 ft.).
- The AF illuminator will not fire in continuous AF mode (∞) or if flash cancel (⊘) is selected.
- The AF illuminator may not operate with focal lengths of 300mm or longer.
- The AF illuminator will not operate with 3x-1x Macro Zoom.
- When an accessory flash is attached, the flash will be used as the AF illuminator in place of the camera's built-in flash unit.

### Custom Function Notes

Cust-7: AF illuminator active (1), AF illuminator disabled (2) (p.108)

## EXPOSURE – Metering System

### 14-Segment Honeycomb-Pattern Metering

This is the camera's standard metering mode and is appropriate for most photographic situations.

- 14-segment honeycomb-pattern metering uses information from the autofocus system to set the metering pattern according to the position of the main subject. The light metered by each segment is then evaluated to determine the degree of spot-lighting or backlighting in the scene.

Subject in the center

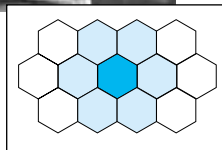

Subject on the right

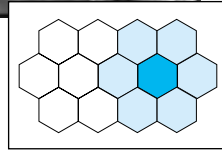

- In manual focus mode with any lens except the 'D' series lenses, the camera switches to center-weighted metering. The metered exposure may be different between autofocus and manual focus.

### Spot Metering

When pressing the spot AE-lock button, only the spot metering area will be used to calculate the exposure.

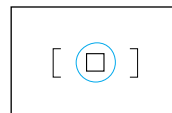

Spot metering area

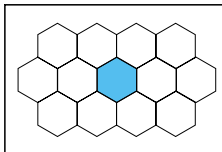

## EXPOSURE – AE-LOCK

### Spot-AE Lock

Spot metering uses only the center honeycomb segment shown by the spot metering area in the viewfinder. You can lock the metered exposure without locking the focus. With a high or low key subject, an object away from the subject can be used to set the shutter speed and aperture. The exposure remains locked until the spot AE lock button is released.

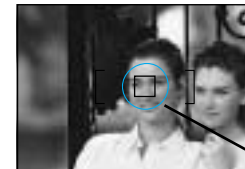

#### 1 Place the spot metering area on the area to be metered.

- Make sure the light falling on the metered area is the same as the light falling on the subject.

Spot metering area

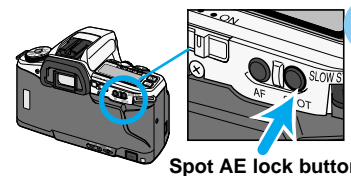

#### 2 Press and hold the spot AE lock button.

-  will be displayed in the viewfinder to indicate the exposure is locked.

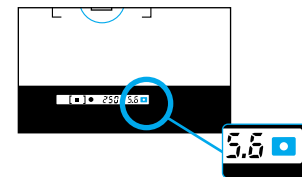

- When using flash, pressing the spot-AE lock button sets the flash mode to slow-sync (p.94).

## EXPOSURE – AE-LOCK



- 3** While pressing the spot-AE lock button, recompose the scene.

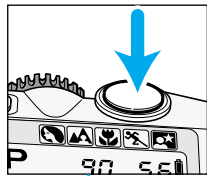

- 4** While still pressing the spot-AE lock button, press the shutter-release button all the way down to take the picture.

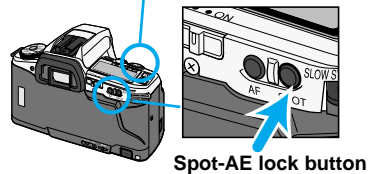

- If the spot-AE lock button is not released after taking the picture, the exposure setting will remain locked.
- Slow-sync is activated when  appears in the viewfinder (p.94).

### Custom Function Notes

Cust-10: Spot-AE lock: activated when the spot-AE lock button is pressed and held (1), or activated when the button is pressed once and then canceled when it is pressed again (2) (p.110).

## TAKING TIME EXPOSURES (buLb)

Set the shutter speed to bulb when you want to take time exposures. When bulb is selected, the shutter remains open as long as the shutter-release button is pressed. The camera's exposure meter does not work with bulb.

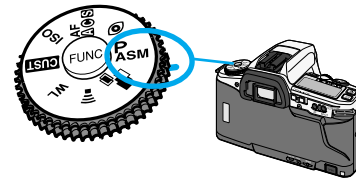

- 1** Mount the camera on a tripod. Set the camera to M mode (p.60).

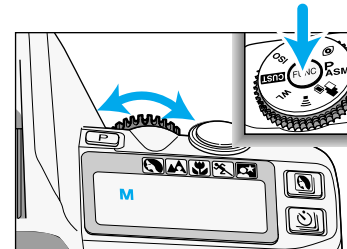

- 2** Turn the control dial counterclockwise until *bulb* appears on the data panel.

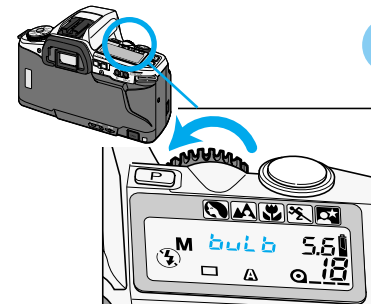

Continued on next page



## TAKING TIME EXPOSURES (buLb)

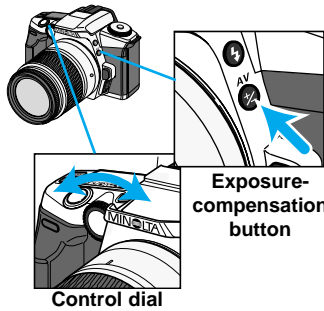

- While pressing the exposure-compensation button, turn the control dial to select the aperture.

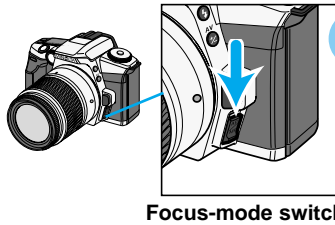

- Compose the scene and focus on your subject.
  - If the scene is too dark for the autofocus to operate, press the focus-mode switch and focus the lens manually (p. 74).

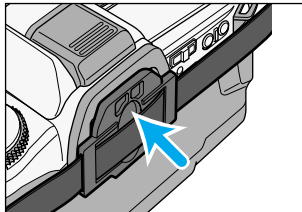

- Firmly press the eyepiece cap into the eyepiece.
  - The eyepiece cap prevents light from entering through the viewfinder and fogging the film.

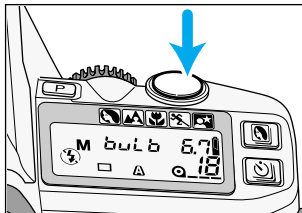

- Press and hold the shutter-release button to take the picture.
  - The shutter remains open as long as the button is pressed.

80

## Attaching the Remote Cord (Sold Separately)

To reduce the camera shake or for long exposures, the shutter can be released with the Remote Cord RC-1000S or RC-1000L.

- Do not use the Wireless Controller IR-1N with this camera. Its use may permanent damage the camera.

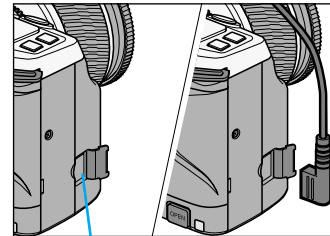

- Open the remote-control-terminal cover.

- Insert the plug into the terminal.

- When removing the Remote Cord RC-1000S or RC-1000L, take care not to pull out the remote-terminal cover with the Remote Cord.
- The Remote-cord Clip (sold separately) can be used to attach the remote cord to the camera strap.

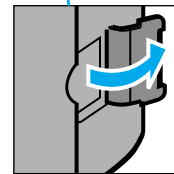

## Using the Remote-Control with Bulb(Sold Separately)

To reduce camera shake, use the optional remote-control IR-3. (sold separately) (p.49).

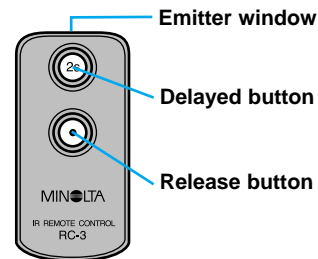

- Set the camera to remote-control mode (p.49).
- Press the release button to open the shutter.
  - Hold the remote control near the sensor on the grip. Take care not to stand in front of the lens.
- Press release button again to close the shutter.

DETAILED  
OPERATION

81

## EXPOSURE COMPENSATION



Compensated Exposure

The scene on the left was underexposed because of the snow. By compensating the exposure by +2Ev, the snow appears white and fresh.

- This effect is most visible with slide film.
- Exposure compensation is not available in M mode.

The metering system in this camera averages the scene's light values to determine the exposure. This is an accurate method for scenes with a normal tones. Bright scenes, such as snowy landscapes or sandy beaches, can deceive the camera's meter and be underexposed. Dark scenes can be overexposed.



Metered Exposure

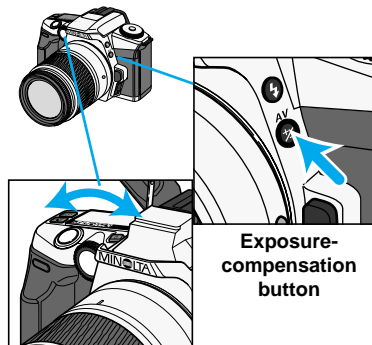

Control dial

Exposure-compensation button

While pressing the exposure-compensation button, turn the control dial until the desired compensation value appears on the data panel.

- The metered exposure can be adjusted by  $\pm 3$  Ev in 0.5 Ev increments.



### Checking Exposure Compensation

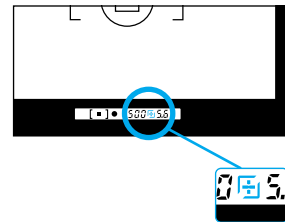

After releasing the exposure compensation button,  $\oplus$  or  $\ominus$  remains on the data panel and in the viewfinder to indicate that the exposure is being compensated.

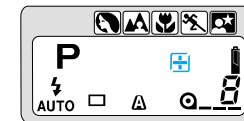

DETAILED  
OPERATION

- To cancel exposure compensation, the camera must be reset manually to 0.0.

## SETTING THE ISO MANUALLY

Set the film speed manually when you want to override DX-coded film or when using non-DX-coded film. Film speeds can be set from ISO 6 to 6400 in 1/3Ev increments.

- Non-DX coded film is initially set to the previous roll's ISO.

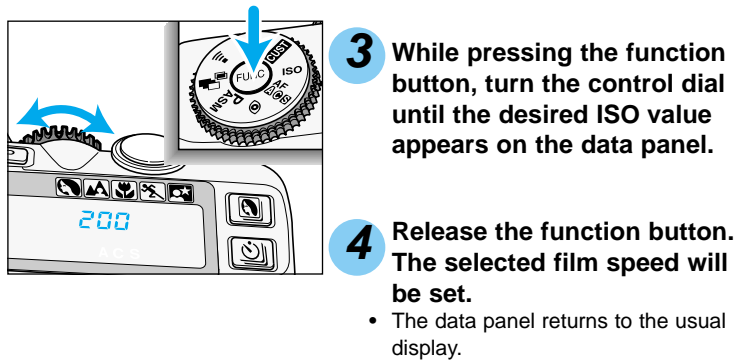
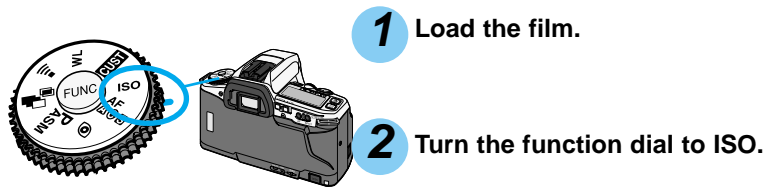

- Exposure compensation in 1/3 Ev increments can be made using the ISO function. Care should be taken because no warning will be displayed indicating the ISO has been changed.

### Custom Function Notes

Cust-4: Manual ISO settings will be canceled when the film is rewound (1), or the manual ISO setting will be stored and applied to future rolls of film with the same DX-coded ISO (2) (p.107).

## EXPOSURE BRACKETING

Bracketing automatically exposes a series of three frames with differing exposures. Bracket your exposures when shooting slides and other films with a low tolerance for exposure error.

- The bracket can be set in increments of 0.3, 0.5, 0.7, or 1.0 Ev.
- The flash cannot be used with bracketing.
- Exposure compensation can be used to adjust the bracket series.

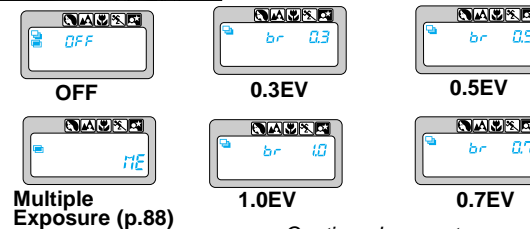
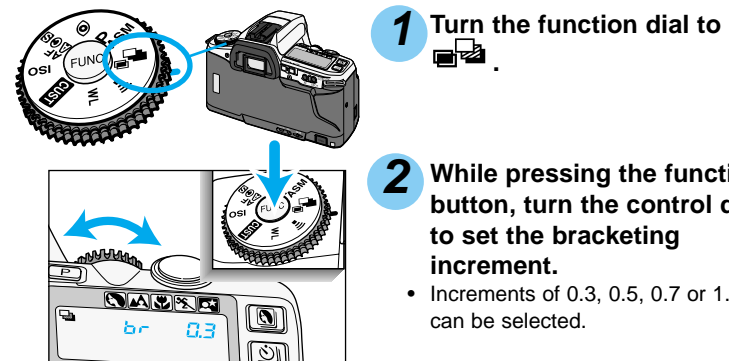

Continued on next page

## EXPOSURE BRACKETING

### Continuous Advance Bracketing

To make an automatic three-frame bracket. The drive mode is automatically set to continuous advance when bracketing is selected.

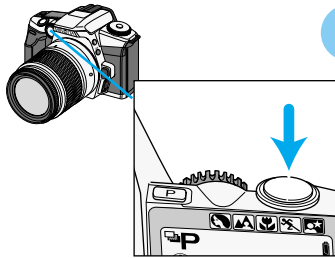



**1** Hold the shutter-release button all the way down to make the bracket.

- Three frames will be taken. Do not release the shutter button until all three exposures are made.
- If the shutter button is released before the three exposures are made, the current bracket will be canceled.
- Exposure is locked with the first frame of the series.

### Single Frame Advance Bracketing

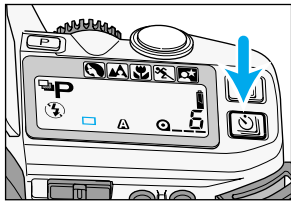
To take each picture of the three-frame bracket individually, set the drive mode to single frame advance.



**1** Press the drive-mode button until  appears on the data panel.

- *br 1* will appear on the data panel after pressing the shutter-release button partway down to indicate the first bracket.

**2** Press the shutter button all the way down to take each bracket.

- The shutter-release button must be pressed for each bracket.
- To cancel the bracketing series, turn the camera off.
- Exposure is locked with the first frame of the series.
- *br 2* and *br 3* will appear on the data panel to indicate the bracket frame.

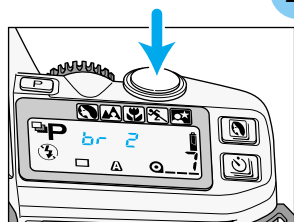

86

### Flash Notes

- The built-in flash is set to flash cancel  when bracketing is selected.
- An attached Minolta accessory flash will be turned off when bracketing is selected.

### Canceling Bracketing

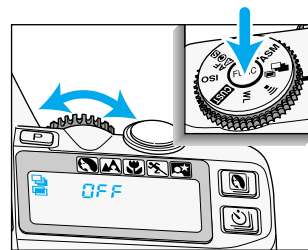

**1** Turn the function dial to .

**2** Press the function button and turn the control dial until *OFF* appears on the data panel.

- Sliding the main switch to OFF in the middle of a bracketing series resets the bracketing series to the first frame (*br 1*).

### Bracketing with the Exposure-compensation Button

This function is a shortcut to take a three-frame bracket in increments of 0.5 Ev.

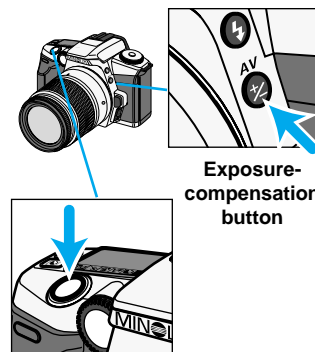

While pressing the exposure-compensation button, press and hold the shutter-release button all the way down.

- The camera automatically exposes a three-frame bracketed series.
- Releasing the shutter-release button before the series is complete, cancels the exposure series.

DETAILED  
OPERATION

87

## MULTIPLE EXPOSURE



The multiple-exposure function makes it possible to expose two or more images on the same frame.

- Flash cannot be used with multiple exposure.

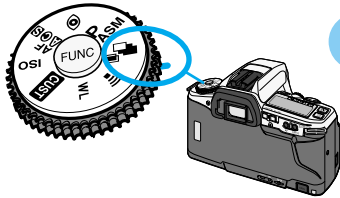

**1** Turn the function dial to .

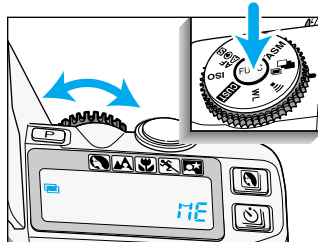

**2** While pressing the function button, turn the control dial until *ME* appears on the data panel.

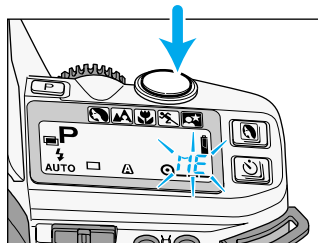

**3** Press the shutter-release button all the way down to take the first exposure.

- ME* blinks on the data panel indicating the next exposure will be the last in the series.
- Go to step 7 when making only 2 exposures.

### Taking more than 2 exposures

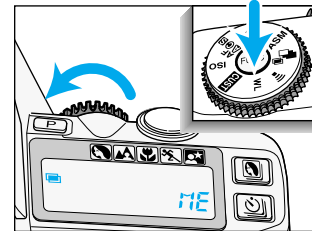

**4** While pressing the function button, turn the control dial one click counterclockwise to stop the *ME* from blinking.

**5** Press the shutter-release button to take the picture.

**6** Repeat 4 and 5 for each additional exposure.

### Taking last exposure

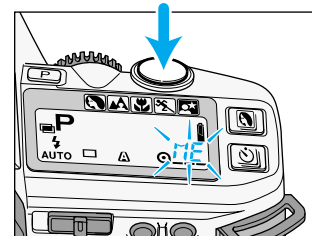

**7** While *ME* is blinking on the data panel, press the shutter-release button all the way down to take the last exposure.

- Multiple-exposure mode is cancelled after the last exposure has been taken.
- The film will be advanced to the next frame.

DETAILED OPERATION

## MULTIPLE EXPOSURE

### Canceling Multiple Exposure

The multiple exposure series can be canceled before the last frame is taken.

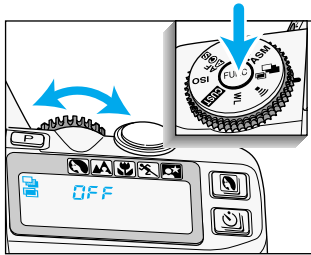

- 1 Turn the function dial to .
- 2 Press the function button and turn the control dial until **OFF** appears on the data panel.

- Sliding the main switch to OFF does not cancel multiple exposure mode.

### Metering Multiple Exposure

The meter in your camera determines exposure (Ev) based on the assumption that only one exposure will be made for each picture. When making multiple exposures, the combined exposure of the series must equal the exposure required for one picture.

- Compensation is not necessary if all of the exposures have dark backgrounds and the subjects of the exposures will not overlap.

Compensate the exposures as follows:

Number of Exposures	1	2	3	4	5	6
Exposure Adjustment	0.0	-1.0	-1.5	-2.0	-2.5	-3.0

- The above corrections are intended as a general guideline. Some testing may be necessary to produce the desired results.
- When using negative film, inform the photofinisher that multiple-exposure pictures are included on the film.

## FLASH

Your camera's built-in flash provides coverage for a 28mm wide-angle lens, with a flash guide number of 12 (ISO100). This section of your manual covers the operation of accessory flashes as well as the built-in flash.

The high accuracy of your camera's flash is achieved by ADI (Advanced Distance Integration) flash metering in combination with the newly developed D series flash units and lenses. Compared with conventional TTL flash metering, ADI flash metering is less influenced by background conditions or the subject's reflectance, providing optimum flash exposures every time.



ADI flash metering



Conventional TTL metering

### Program Flash

An optional accessory flash, such as the 5600HS(D) or 3600HS(D), improves flash performance over the built-in flash. The flash units fit in the accessory shoe located on the top of the camera.

- The flash signals for the accessory flash are the same as those for the built-in flash (p. 35).
- Refer to the accessory flash's instruction manual for the flash range. For the 5600HS(D), 5400HS, and 5400xi, the flash range is on the back of the flash units.
- Refer to the accessory flash's instruction manual to attach the flash.

- The shutter speed is set automatically to a 1/90 second or slower. High-speed sync is not compatible with this camera.

## FLASH

### Attaching the Program Flash

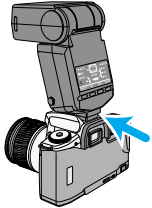

The accessory flash units fit in the shoe located on the top of your camera.

### Flash Metering

Flash metering changes according to the flash unit and lens being used.

	D lens	Other lens
<b>5600HS(D)</b> <b>3600HS(D)</b>	ADI metering with pre-flash	Pre-flash metering
<b>5400HS</b>	Pre-flash metering	Pre-flash metering
<b>Built-in flash</b>	ADI metering without pre-flash	TTL metering
<b>Other flashes</b>	TTL metering	TTL metering

- When an off-camera cable or bounce flash is used, the TTL metering mode will be automatically set.
- High-speed sync does not work with this camera even when the flash has the high-speed sync function. However, when using the (D) flash, turn the HSS on in order to fire the pre-flash for ADI or DI metering.

92

#### TTL metering (Through The Lens):

The TTL flash metering system controls the flash during the exposure automatically.

#### Pre-flash metering:

In combination with TTL metering, a pre-flash fires before the main exposure. The pre-flash is metered with 14 segment honeycomb pattern and fed back to the flash exposure system to determine the reflectance of the scene.

#### ADI metering (Advanced Distance Integration):

Flash metering is controlled by distance information from D series lenses in addition to TTL metering. With the 5600HS (D) and 3600HS (D) accessory flash units, a pre-flash is also used. With ADI metering, flash output is less influenced by background conditions or the subject's reflectance.

### Use of a Flash/Color Meter with Pre-Flash

When pre-flash fires, a flash/color meter cannot meter accurately. This is because the purpose of pre-flash is to assist ADI/Pre-flash metering, not to provide illumination for the picture. Cancel HSS function of the program flash (see flash manual) or eliminate the influence on metering using Custom 11-2 (p. 111). However, if you use the test-flash button on the flash, the pre-flash will not fire.

### When Using a Close-up Diffuser, Certain Filters and Lenses

When close-up diffuser CD-1000, or a filter whose stop's increase is not 0 (i.e., ND) is used, or when the focus-range limiter or macro release of certain lenses are used, the proper exposure will not be obtained by ADI or Pre-flash metering. Cancel HSS function of the program flash (see flash manual) or eliminate the influence on metering using Custom 11-2 (p. 111).

DETAILED  
OPERATION

93

## SLOW-SYNC

In P and A modes, slow-shutter sync sets the shutter speed and aperture value for ambient lighting and balances the flash output with the exposure .

- Slow sync cannot be used in S mode, or M mode.



Slow-shutter Sync



Conventional Flash

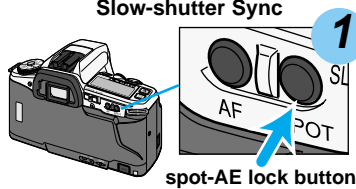

spot-AE lock button

**1** With  $\text{⚡}$  or  $\text{⚡}_{\text{AUTO}}$  on the data panel, press the spot-AE lock button to set the ambient light exposure.

- In P mode, the flash will automatically be activated. In A mode, press the flash-mode button to activate the built-in flash.
- $\text{■}$  and the locked exposure will be displayed in the viewfinder.

**2** While holding the spot-AE lock button, press the shutter-release button all the way down to take the picture.

- The slow-sync effect is the same as the night portrait subject program (p.44).
- Use a tripod if the shutter speed is too slow to allow sharp, hand-held pictures.
- When  $\text{⚡}$  is not on the data panel, the camera is in spot-metering mode and not in slow sync (p.77).

### Custom Function Notes

Cust-10: Spot-AE lock: activated when the AE lock button is pressed and held (1), or activated when the button is pressed once and then canceled when it is pressed again (2) (p.110).

## WIRELESS/REMOTE FLASH

Photographs taken with the flash attached to the camera are flat as shown in photo ① . Use an accessory flash positioned away from the camera to obtain three-dimensional lighting as shown in photo ② .

When taking this type of photograph, the camera and the flash unit are most commonly connected by cable. The use of the 5600HS (D), 3600HS (D), 5400HS, 5400xi, or 3500xi flash unit eliminates the need for a cable. The flash units are controlled by the camera's built-in flash. This type of flash control is referred to as wireless or remote flash. The proper exposure is determined automatically by the camera.



Normal flash



Wireless flash

- The shutter speed will be set to slower than 1/45 second automatically.
- Flash and color meters cannot be used with wireless/remote flash.
- Red-eye reduction cannot be used with wireless/remote flash. Red-eye reduction is disabled when the wireless/remote flash mode is active. If red-eye reduction is set when wireless/remote flash is active, wireless/remote flash mode is canceled (p.38).



## WIRELESS/REMOTE FLASH

### Setting Wireless/Remote Flash Mode

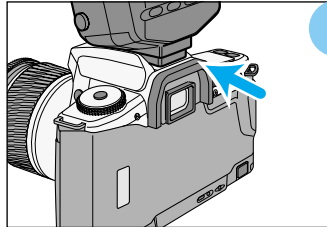

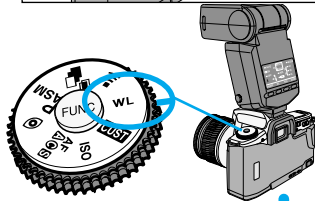

**1** Attach the accessory flash to the camera before turning the flash and camera on.

- The flash must be mounted on the accessory shoe because the camera needs to send a signal to the flash to turn on its wireless/remote function.

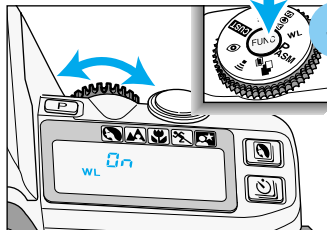

**2** With the camera and flash on, turn the function dial to WL.



**3** While pressing the function button, turn the control dial until WL and  appear on the camera's data panel.

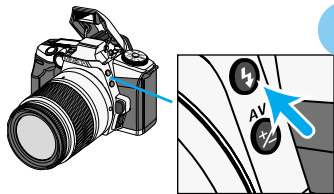

**4** Detach the accessory flash, then press the camera's flash-mode button to raise the built-in flash.

Flash-mode button

### Taking Pictures in Wireless/Remote Flash Mode

The accessory flash is controlled by a light signal from the built-in flash. Although the built-in flash fires, it does not add to the exposure, but simply controls the accessory flash. The position of the camera and flash is critical to control the lighting of the subject.

**1** Position your camera and flash unit using the information of this page.

- The example below is with the 3600HS (D) flash unit. For other flash units, refer to the instruction manual for the correct camera to subject and flash to subject distances.
- Photograph in dark locations.

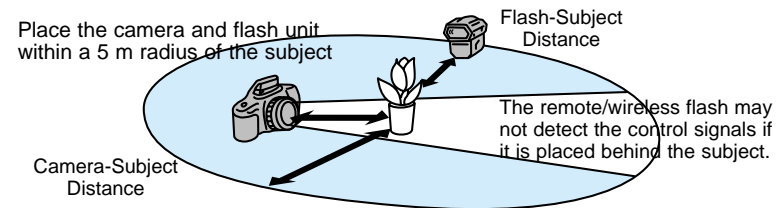

ISO 100

Aperture	camera-subject distance	Flash-subject distance
f/2.8	1.4 - 5.0m / 4.6 - 16.4 ft.	1.4 - 5.0m / 4.6 - 16.4 ft.
f/4	1.0 - 5.0m / 3.3 - 16.4 ft.	1.0 - 3.5m / 3.3 - 11.5 ft.
f/5.6	1.0 - 5.0m / 3.3 - 16.4 ft.	1.0 - 2.5m / 3.3 - 8.2 ft.

ISO 400

Aperture	camera-subject distance	Flash-subject distance
f/2.8	2.8 - 5.0m / 9.2 - 16.4 ft.	2.8 - 5.0m / 9.2 - 16.4 ft.
f/4	2.0 - 5.0m / 6.6 - 16.4 ft.	2.0 - 5.0m / 6.6 - 16.4 ft.
f/5.6	2.0 - 5.0m / 6.6 - 16.4 ft.	2.0 - 5.0m / 6.6 - 16.4 ft.

DETAILED OPERATION

Continued on next page

## WIRELESS/REMOTE FLASH

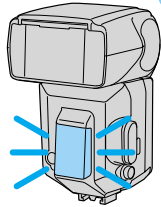

### 2 Wait until both flash units are fully charged.

- ⚡ appears in the viewfinder when the built-in flash is charged.
- When the wireless/remote flash is charged, ⚡ on the rear of the flash is lit.
- Pressing the spot-AE lock button will test fire the accessory flash. If the accessory flash does not fire, change its position.
- To test fire the accessory flash, custom 10 should be set to 1 (p.110).

### 3 Press the shutter-release button all the way down to take the picture.

## Canceling Wireless/Remote Flash Mode

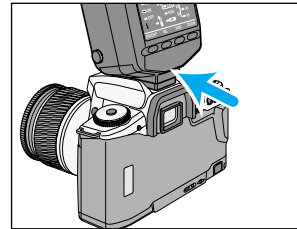

### 1 Attach the flash to the camera.

- The camera and flash should be on.

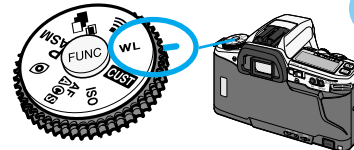

### 2 Turn the function dial to WL.

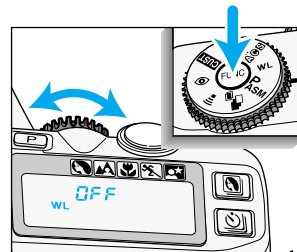

### 3 While pressing the function button, turn the control dial until WL and OFF appear on the camera's data panel.

### 4 Detach the accessory flash.

- Turning off the main switch of the camera with the accessory flash attached also cancels wireless flash. If the flash is not attached, the flash's wireless/remote function will not be canceled. If this happens, see the flash's instruction manual to cancel the function.

DETAILED  
OPERATION

## FOR OWNERS OF THE QUARTZ DATE MODEL

The quartz-date function lets you record the date or time on the lower-left corner of the photograph. The quartz date back has an automatic calendar through the year 2039.

- Imprinted data may be difficult to read if the lower-left corner of the photograph is bright or non-uniform.
- Do not use the data back when temperatures are outside the range of 0° to 50°C (32° to 122°F).
- Since the date is recorded when the film is advanced to the next frame, sometimes the last frame of the roll will not have the date printed on it.

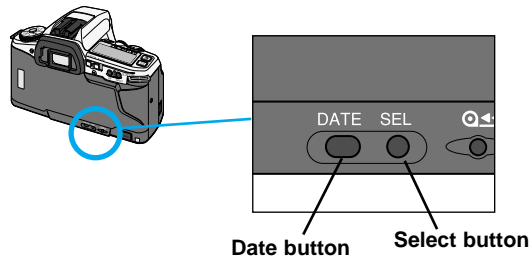

### Setting the Date or Time

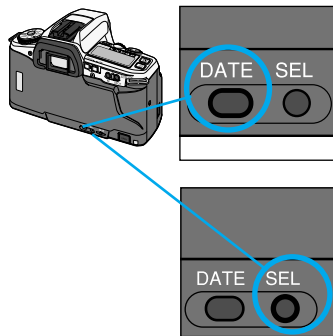

- 1 Press the date button.**
- 2 Press the select button (SEL) to select the year, month, day, hour, or minute.**
  - The item that can be changed will blink.
  - The data back has a 24-hour clock. 2pm should be set as 14:00.
  - The item will cycle as follows.

Year → Month → Day → Hour → Minute

100

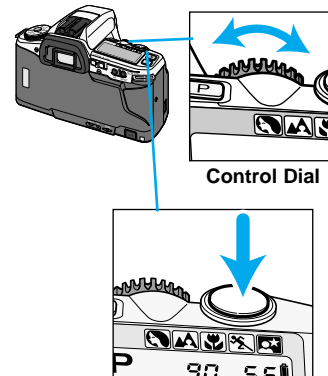

- 3 Turn the control dial to change the date and time values.**
  - Data continues changing as long as the dial turns.
- 4 Repeat steps 2 and 3 until the date and time are displayed correctly.**
- 5 Press the shutter-release button to set the date and time.**
  - The usual display will return.

- The current date and time are stored in a memory register each time the camera is turned on or off. This feature saves time resetting the clock and calendar when changing batteries, see page 21.

### Imprinting the Date or Time

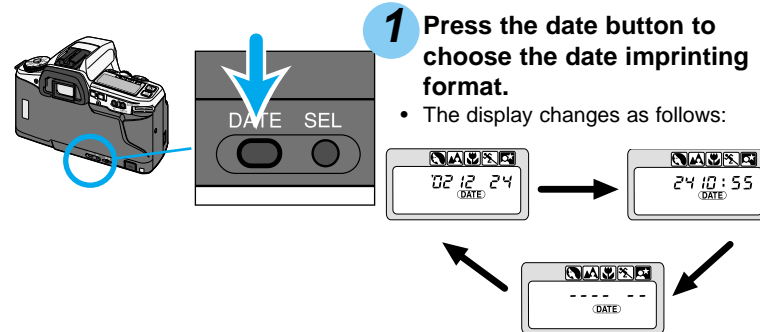





- 1 Press the date button to choose the date imprinting format.**
  - The display changes as follows:
- 2 Press the shutter-release button to set the format.**

DETAILED OPERATION

101

## FOR OWNERS OF THE QUARTZ DATE MODEL

### Changing the Date Format

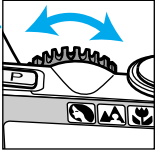
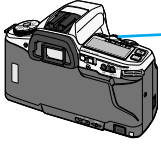
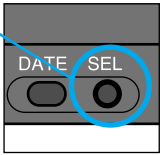
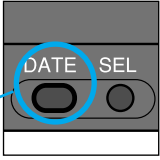
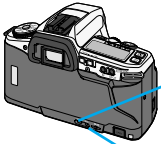

**1** Press the date button.

**2** Press and hold the select button (SEL) for 3 seconds until the date on the data panel blinks.

**3** Turn the control dial to change the format.

- The format will change in the following sequence:

Year / Month / Day      Month / Day / Year      Day / Month / Year

**4** Press the shutter-release button to set the format.

- The usual display will return.

- The clock and calendar are powered by the camera's batteries. If the batteries are removed, and the date and time will reset, date imprinting function will be disabled. To store the date and time when changing batteries, see page 21.
- When the date has not been set, the date settings blink on the data panel when the camera is turned on.

# CUSTOM FUNCTIONS

## CUSTOM FUNCTIONS

Function		Setting		
Cust 1	AF / Shutter-release Priority	1	AF Priority	106
		2	Shutter-release Priority	
Cust 2	Film Rewind Start	1	Automatic	106
		2	Manual	
Cust 3	Film Tip	1	Film Tip Rewound	107
		2	Film Tip Left Out	
Cust 4	DX Memory	1	DX Memory Off	107
		2	DX Memory On	
Cust 5	Shutter-release Lock (Film)	1	Shutter-release Lock Off	107
		2	Shutter-release Lock On	
Cust 6	Focus-hold Button (Lens)	1	Focus Hold	108
		2	Continuous Autofocus	
Cust 7	AF Illuminator (built-in flash)	1	AF Illuminator On	108
		2	AF Illuminator Off	
Cust 8	P Mode Settings	1	Normal P Mode	109
		2	PA Mode	
		3	Ps Mode	
Cust 9	Spot AF Lock Button	1	Select Spot Focus Area	109
		2	Select Focus Area	
		3	Switch Between the Wide Focus And Spot Focus	
Cust 10	Spot-AE Lock Button	1	Hold to Activate	110
		2	Press Once to Activate, Press Again to Cancel	
Cust 11	Flash Metering	1	ADI Flash Metering	111
		2	TTL Flash Metering	
Cust 12	Shutter-release Lock (Lens)	1	Shutter cannot be released if a lens is not attached.	112
		2	Shutter can be released if a lens is not attached.	

Using the custom functions, you can tailor camera settings to suit your shooting style or preferences. Initially all the custom functions are set to 1. The functions are explained on pages 106 - 112.

### Setting Custom Functions

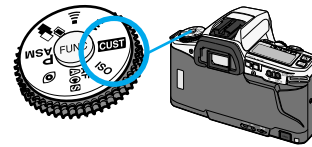

**1** Turn the function dial to CUST.

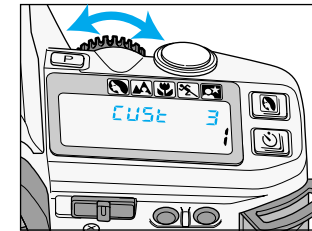

**2** Turn the control dial to select the custom function number to be changed.

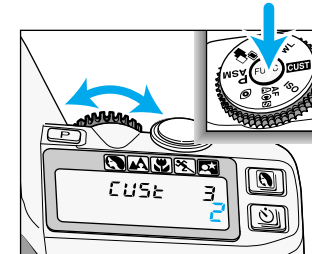

**3** While pressing the function button, turn the control dial to select the desired setting.

**4** Turn the function dial to any position other than CUST.

- If the function dial is set to CUST, the camera can take photographs, but all buttons and switches, except for the shutter-release button, are disabled.
- Custom settings must be reset manually, and are not effected by the program-reset button or by turning the camera off.

## CUSTOM FUNCTIONS

### Resetting All of the Custom Functions to Default

You can reset all of the custom functions to their default settings (1).

- 1 Turn the main switch to OFF.
- 2 Turn the function dial to CUST.
- 3 While pressing the function button, slide the main switch from OFF to ON.

- When the camera turns on,  $\text{ELr}$  will blink on the data panel while the function button is pressed.

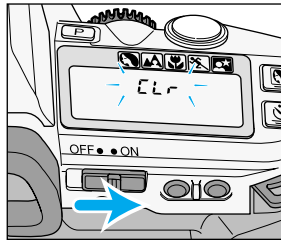

### Custom 1 - AF / Shutter-release Priority

#### (1) AF priority

Shutter will not release until ● or ● appears in the viewfinder.

#### (2) Shutter-release Priority

Shutter releases even if the focus cannot be confirmed. Use shutter-release priority when photographing moving subjects.

- When continuous-advance mode is selected, the camera will not update the focus while the shutter-release button is pressed.

### Custom 2 - Film Rewind Start

#### (1) Automatic

Film is automatically rewound at the end of the roll.

#### (2) Manual

The manual-rewind button must be pressed to initiate rewind (p. 26).

106

### Custom 3 - Film Tip

#### (1) Film Tip Rewound

Film is completely rewound into the cartridge.

#### (2) Film Tip Left Out

The film leader is exposed after rewind.

- Sliding the main switch to OFF during rewinding causes the film tip to be rewound into the cartridge when the camera is turned on again.



### Custom 4 - DX Memory

#### (1) DX Memory Off

Film speed is always set to the DX-coded ISO of the film. Non-DX-coded film is set to the ISO of the previous DX-coded roll.

#### (2) DX Memory On

Manual changes to the film speed of a DX-coded film are saved and applied to future rolls with the same DX-coded ISO. Use when a particular film is consistently pushed or pulled in its processing.

- For setting the film speed manually, see page 84.

### Custom 5 - Shutter-release Lock (Film)

#### (1) Shutter-release Lock Off

Shutter can be released even if there is no film in the camera.

#### (2) Shutter-release Lock On

Shutter cannot be released unless film is loaded.

- When film is not loaded, if the shutter-release button is pressed all the way down, 0 will blink in the viewfinder and on the data panel.
- While the back cover is open, the shutter can be released.

107

## CUSTOM FUNCTIONS

### Custom 6 - Focus-hold Button (Lens)

This custom function changes the operation of a lens with a focus-hold button.

#### (1) Focus Hold

Pressing the focus-hold button on the lens locks the autofocus.

#### (2) Continuous Autofocus

Press and hold the focus-hold button on the lens to activate the continuous-autofocus mode.

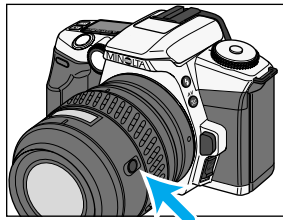

Focus-hold button

### Custom 7- AF Illuminator (Built-in flash)

#### (1) AF Illuminator On

The built-in flash is used as an AF illuminator and will fire when necessary to assist the autofocus system.

- The AF illuminator does not fire when flash cancel is selected.

#### (2) AF Illuminator Off

The AF illuminator function is canceled. Other flash functions will operate normally.

- An attached accessory flash's AF illuminator will not be cancelled.

### Custom 8 - P Mode Settings

#### (1) Normal P Mode (p. 63)

You cannot shift the shutter speed or aperture in P mode.

- Flash will fire automatically when it's necessary.

#### (2) PA Mode (p. 63)

The aperture can be shifted in PA mode. The shutter speed will automatically compensate to provide a correct exposure.

- The flash mode will be set to flash cancel.
- To use fill flash, press the flash mode button to pop-up the built-in flash. PA mode will be canceled while the flash is being used, but it is reset when the flash is lowered.

#### (3) Ps Mode (p. 63)

The shutter speed can be shifted in P mode. The aperture will automatically compensate to provide a correct exposure.

- The flash mode will be set to flash cancel.
- To use fill flash, press the flash mode button to pop-up the built-in flash. PS mode will be canceled while the flash is being used, but it is reset when the flash is lowered.

### Custom 9 - Spot AF button

This custom function changes the operation of the spot AF button.

#### (1) Select spot focus area

While pressing the spot AF button, the spot focus area is activated. Local focus areas are selected with the control dial while pressing the spot AF button. When the spot AF button is released, the wide focus area is active.

#### (2) Select focus area.

Wide focus area and local focus areas set with the control dial while pressing the spot AF button. The focus area remains selected even after releasing the spot AF button.

#### (3) Switch between the wide focus frame and the spot focus area.

Every time the spot AF button is pressed, the camera switches between the spot focus area and wide focus frame. The following displays appears on the data panel and in the viewfinder.

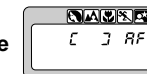

## CUSTOM FUNCTIONS

### Custom 10 - Spot-AE Lock Button

This custom function changes the operation of spot-AE lock button.

- When the built-in flash is up or an attached accessory flash is on and the spot-AE lock button is pressed, slow sync will be activated (p. 94).

#### **(1) Hold to activate**

The spot metering area is active until the spot-AE lock button is released.

#### **(2) Press once to activate, press again to cancel.**

The spot metering area is activated when the spot-AE lock button is pressed and canceled when the button is pressed again.

- When the spot metering area is active, pressing the program-reset button, turning the camera off, or changing the position of the built-in flash cancels the metering area.
-  will appear in the viewfinder when the spot metering area is active.

### Custom 11 - Flash Metering

Your camera uses ADI flash metering as the standard flash metering mode, but it can be changed.

- This applies to both the built-in and accessory flash.

#### **(1) ADI Flash Metering**

When the flash fires, ADI or pre-flash metering will be employed.

- Flash metering changes according to the flash unit and lens being used.

#### **(2) TTL Flash Metering**

When the flash fires, TTL metering will be employed.

- To use flash or color meters, flash diffusers, or neutral density filters, the flash mode must be set to TTL metering.

### Custom 12 - Shutter-release Lock (Lens)

#### **(1) Shutter cannot be released if a lens is not attached.**

- [ - - ] appears on the data panel when the shutter button is pressed partway down.

#### **(2) Shutter can be released if a lens is not attached.**

- Use when mounting the camera to a non-coupling lens mount (telescope, microscope, etc).



## PROGRAM-RESET BUTTON

Press the program-reset button to return the following camera functions to their program settings.

	SETTING
Exposure mode	P
Autofocus mode	Autofocus
Focus area	Wide focus frame
Flash mode	Autoflash*
Exposure Compensation	0.0
Drive Mode	Single Frame Advance
Continuous Advance	Canceled
Self-timer	Canceled
Wireless/Remote Control	Canceled
Wireless/Remote Flash	Canceled
Bracketing	Canceled
Multiple Exposure	Canceled
Subject Program Select	Canceled

\*With the custom function set to 8-2 or 8-3, PA or Ps mode will not be reset. The flash mode will be set to flash cancel or fill flash.

**Following settings will not change;**

- The date and time settings
- Red-eye reduction
- ISO
- Custom settings
- Audio Signal

## ACCESSORY INFORMATION

This camera is designed to work specifically with lenses and accessories manufactured and distributed by Minolta. Using incompatible accessories with this camera may result in unsatisfactory performance or damage to the camera and its accessories.

### Lenses

- All Minolta AF lenses can be used with this camera.
- MD and MC series lenses (manual focus) cannot be used with this camera.

### Lens Specifications

	AF 28-80mm f/3.5-5.6(D)	AF 75-300mm f/4.5-5.6(D)
Construction:	8 elements/7 groups	13 elements/10 groups
Angle of View:	75° – 30°	32° – 8°10'
Min. Focus Distance:	0.4m / 1.2 ft.	1.5m / 4.9ft.
Max. Magnification:	0.24X	0.25X
Min. Aperture:	f/22–38	f/32–38
Filter Diameter:	55mm	55mm
Dimensions:	63 (dia.) x 68 (L) mm / 2.5 (dia.) x 2.7 (L) inch.	71 (dia.)x 122 (L) mm / 2.8 (dia.) x 4.8 (L) inch.
Weight:	190g / 6.7oz	460g / 16.2oz

- Specifications are based on the latest information available at the time of printing and are subject to change without notice.

### Lens Hood

Flare is non-image forming light that degrades image quality. A lens hood improves image quality by reducing flare.

- Remove the lens hood before using the camera's built-in flash.

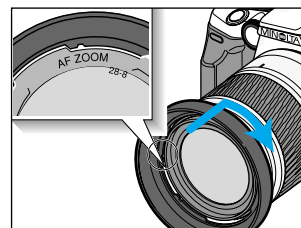

**Fit the lens hood into the mount at the end of the lens barrel, then turn the hood clockwise until it clicks.**

- To store the hood, reverse it, attach it to the lens as described above, then replace the lens cap.

### Accessory Flashes

**When using an accessory flash, the flash mode can be selected using the camera or the flash.**

- All Minolta i, si, and HS, HS(D) series flash units, the Macro Twin Flash 2400, the Macro Ring Flash 1200, and the Vectis SF-1 flash are compatible with this camera.
- The Flash Shoe Adapter FS-1100 is required to mount AF series flash units (4000AF, 2800AF, 1800AF, and Macro flash 1200AF).
- When the FS-1100 is used:
  - The flash will fire every time the shutter is released.
  - The AF illuminator will not activate.
  - The built-in flash is set to fill flash when the accessory flash is removed.
- X-series flashes and flashes sold by other manufacturers cannot be used with this camera.

## ACCESSORY INFORMATION

### Accessory Flash Control

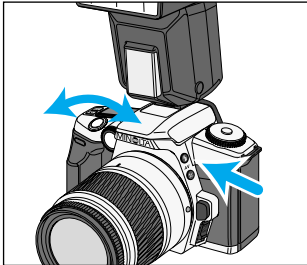

#### **Setting the flash mode with the camera**

While pressing the flash-mode button, turn the control dial to select the desired flash mode.

- The camera sets the flash mode on the accessory flash immediately.

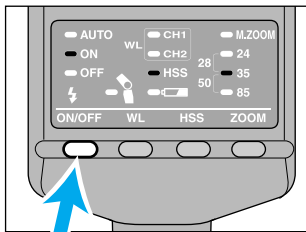

3600HS(D)

#### **Setting the flash mode with the flash**

With the flash off, attach it to the accessory shoe. Turn the flash on. The current flash mode on the accessory flash will be set in the camera when the shutter-release button is pressed partway down.

- The camera will display the corresponding flash mode icon on the data panel.
- The viewfinder's flash signal are used with the accessory flash.

- Red-eye reduction cannot be used with accessory flashes.
- In P mode and subject-program modes, only autoflash or flash cancel can be set. To use fill flash, the flash mode must be set using the camera.
- In A, S, and M mode, only fill flash or flash cancel can be set.

### AA Battery Pack BP-200

AA Battery Pack BP-200 allows the camera to be powered by four AA alkaline or Ni-MH batteries.

### Angle FinderV<sub>N</sub> /MagnifierV<sub>N</sub>

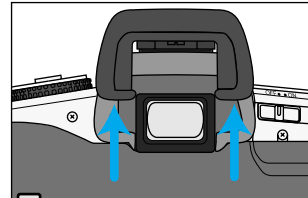

Remove the eyepiece cup when attaching a finder accessory.

- Push up to remove the eyepiece cup.

### Eyepiece Corrector 1000

For eyeglass wearers, an Eyepiece Corrector 1000 can be attached to the viewfinder. Nine correction lenses are available from - 4 to + 3 diopters.

### Incompatible Accessories

The following accessories are not compatible with this camera.

- Control Grip CG-1000
- Data Receiver DR-1000
- Wireless Controller IR-1N
- Vertical Control Grip VC-7
- Data Saver DS-100
- Wireless/Remote Flash Controller

- The camera can be permanently damage if the Wireless Controller IR-1N is used.
- The information in this manual is relevant for products introduced before May 2002. Contact the nearest authorized Minolta Service Facility to obtain information for products released after this date.

## TROUBLE SHOOTING

Contact your nearest Minolta Service Facility if the following information does not cover the problem which you are experiencing or the condition continues.

Problem	Cause	Solution	Page
Autofocus does not work when the shutter-release button is pressed partway down.	Situation is unsuitable for autofocus.	Use focus lock or manual focus.	34/ 74
	Camera is set to manual focus mode.	Hold the focus-mode switch down.	74
	Subject is too close.	Check the minimum focus distance for your lens.	—
Shutter cannot be released.	Focus cannot be confirmed.	Use focus lock or manual focus.	34/ 74
	Camera is attached to a microscope or telescope and custom function 12-1 is set.	Set custom 12 to setting 2.	111
	Custom function is set to 5-2 (shutter-release lock (Film)).	Set custom 5 to setting 1.	107
Flash fires when the shutter-release button is pressed partway down.	Flash was used as AF illuminator to assist the autofocus system.	To turn off the AF illuminator, set the flash mode to flash cancel or custom 7 to setting 2	108
Picture is blurred.	Flash did not fire in a low-light situation and the shutter speed was slow.	Use fill flash, a tripod, or faster film.	—

118

Problem	Cause	Solution	Page
Flash picture is too dark.	Subject is beyond flash range.	Make sure the subject is within the flash range.	36
When using the built-in flash, the bottom of the picture is dark.	Lens hood was attached or subject distance was less than 1m.	Remove the lens hood. To prevent lens shadowing, the subject must be at least 1m (3.3ft.) from the camera.	—
Err appears on the data panel.	Camera malfunction	Turning the camera off and on. If normal camera operation does not resume or the camera malfunctions repeatedly, contact an authorized Minolta Service Facility.	
After the film rewinds, the back cover can not be opened.		<p>This camera has a safety-lock feature and the back cover cannot be opened if film is loaded. In case the back cannot be opened, following these steps.</p> <ul style="list-style-type: none"> <li>Remove the film in a dark place or under a thick blanket. After removing the film, contact an authorized Minolta Service Facility to repair your camera.</li> </ul> <ol style="list-style-type: none"> <li>Turn the main switch to OFF.</li> <li>Turn the function dial to ISO.</li> <li>While pressing the function dial and spot-AE lock button, turn the main switch to ON. The film-chamber-lock indicator should turn black. The back cover can now be opened.</li> </ol> <p>If the back cover did not open,</p> <ol style="list-style-type: none"> <li>Find the lever located near the film-chamber release.</li> <li>Slide the lever down to open the cover.</li> </ol>	

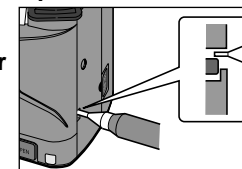

119

APPENDIX

## CARE AND STORAGE

### Operating Temperature and Conditions

- This camera is designed for use from -20° to 50°C (4 to 122 °F).
- Never leave your camera where it may be subjected to extreme temperatures such as in the glove compartment of a car.
- The data panel response time will be slow at cold temperatures. The display will temporarily darken at high temperatures, but will be restored when the temperature normalizes.
- This camera is not waterproof or splashproof. When using the camera in the rain, protect the camera and lens.
- Never subject the camera to extreme humidity.
- To prevent condensation from forming, place the camera in a sealed plastic bag when bringing it from cold environment to a warm environment. Allow it to come to room temperature before removing it from the bag.
- The low-battery symbol may appear even with fresh batteries depending on the storage conditions. To restore camera power, repeat turning the camera on and off.
- Battery capacity decreases at colder temperatures. Keep your camera and spare batteries in a warm inside pocket when shooting in cold weather. Batteries will regain some of their capacity when warmed to normal operating temperature.

### Before Important Events

- Check the camera's operation carefully, or take test photographs.
- Minolta is not responsible for any loss that may occur due to an equipment malfunction.

120

### Cleaning

- If the camera or lens barrel is dirty, wipe it gently with a soft, clean, dry cloth. If the camera or lens comes in contact with sand, gently blow away loose particles - wiping may scratch the surface.
- To clean the lens surface, first brush away any dust or sand then, if necessary, moisten a lens tissue with lens cleaning fluid and gently wipe the lens in a circular motion, starting from the center.
- Never place lens fluid directly on the lens.
- Never touch the interior of the camera, especially the shutter and mirror, doing so may impair their alignment and movement.
- Dust on the mirror will not affect the exposure but may affect the focus. Use a blower brush to remove dust from or around the mirror.
- Never use compressed air to clean the camera's interior, it may cause damage to sensitive interior parts.
- Never use organic solvents to clean the camera.
- Never touch the lens surface with your fingers.

### Storage

When storing your camera for extended periods,

- Always attach the protective caps.
- Store in a cool, dry, and well-ventilated area away from dust and chemicals such as moth balls. For long periods, place the camera in an airtight container with a silica gel drying agent.
- Periodically release the camera's shutter to keep it operating properly.
- Before using after prolonged storage, check the camera's operation to make sure it is functioning properly.

### Questions and Service

- If you have questions about your camera, contact your local camera dealer or write to the Minolta distributor in your area.
- Before shipping your camera for repair, please contact an authorized Minolta Service Facility for details.

121

## SPECIFICATIONS

**Camera Type:** 35mm SLR with built-in flash, autoexposure (AE), and action predictive autofocus (AF)

**Lens Mount:** Minolta A-type bayonet mount

**Viewfinder:** SLR roof mirror type, 90% field of view, Magnification: 0.75X

**Shutter**

**Type:** Electronically-controlled, vertical-traverse, focal-plane type

**Speeds:** 30 sec. - 1/2000 sec., bulb

**Flash sync speed:** 1/90s or slower

**Focus**

**Type:** TTL phase-detection system, multi metering with cross hair type CCD line sensor metering cell. Autofocus and manual focus modes.

**AF Sensitivity Range:** EV -1 to 18 (ISO 100)

**AF Illuminator:** Built-in with range of 1.0 - 5.0m (3.3 - 16.4 ft.) Automatically activated in low-light/ low-contrast situations.

**AF Control:** Single-shot, continuous, automatic AF-mode selection.

**Exposure Modes:** P, A, S, M, (PA/PS available) and 5 Subject Program modes (Portrait, Landscape, Close-up, Sports, Night Portrait)

**Type:** TTL metering; direct TTL metering for flash

**Metering Cell:** 14-segment honeycomb pattern SPC for ambient light and 4-segment flash-metering SPC for flash.

**Metering Range:** 14-segment honeycomb pattern metering: EV 1 - 20, Spot metering: EV 4 - 20 (ISO 100, f/1.4 lens)

**Film-speed Setting:** Automatic: ISO 25 to 5000 for DX-coded film. Manual: ISO 6 to 6400 in 1/3 EV increments. Flash: ISO 25 - 1000.

**Film Transport**

**Loading:** Auto load

**Drive Modes:** Single frame, continuous advance (1.7 frames/sec.), self-timer, exposure

**Rewind:** bracketing, and multiple exposure. Auto rewind, manual start (Count-down display)

**Frame counter:** Forward (shows number of exposures taken)

### **Built-in Flash**

**GN:** 12 (ISO 100 in meters)  
39 (ISO 100 in feet)

**Coverage:** 28mm angle of view

### **Additional**

**Power:** Two CR2 lithium batteries

### **Battery Performance:**

Flash Use (%)	Condition A		Condition B	
	20 °C (68 °F)	-10 °C (14°F)	20 °C (68 °F)	-10 °C (14°F)
0	30 rolls	24 rolls	45 rolls	35 rolls
50	14 rolls	11 rolls	18 rolls	14 rolls
100	9 rolls	7 rolls	11 rolls	9 rolls

\* 24 exposure rolls

Condition A: Lens(28-80 f/3.5-5.6) focused from infinity to 2m (6.6 ft.) three times and the shutter-release button held partway down for ten seconds before each exposure.

Condition B: Lens(28-80 f/3.5-5.6) focused from infinity to 2m (6.6 ft.) and the shutter-release button held partway down for five seconds before each exposure.

- Battery performance will vary with usage conditions.
- Exposures taken at a rate of 2 rolls/month.

**Dimensions (WxHxD):** 127(W) x 87(H) x 60.5(D) mm  
5(W)x 3.4(H)x 2.4(D) in.

**Weight :** 315g (11.1oz) w/o camera battery

Specifications and accessories are based on the latest information available at the time of printing and are subject to change without notice.

## INDEX

Subject	Page
<b>A</b>	
ADI Flash Metering .....	91, 92, 93
Aperture Priority .....	55
Audio Signal .....	29
Automatic AF .....	71
<b>B</b>	
Battery Conditions Indicators .....	20
Bracketing .....	86
Bulb .....	79
<b>C</b>	
Continuous AF .....	72
Cust .....	103
<b>D</b>	
Date Format .....	102
DX-code Film .....	23
Depth-of-field .....	52, 55
<b>E</b>	
Ev .....	82
Exposure Compensation .....	82
Eyepiece Cap .....	18
<b>F</b>	
FCC .....	6
Flash Cancel .....	37
Flash Range .....	36
Flash-Subject Distance in Wireless/Remote Flash Mode .....	97
Fill Flash .....	37
Film-chamber Lock Indicator .....	25
Film Tip .....	23
Focus Area Indicator .....	67
Focusing Ring .....	74
ISO .....	84

Subject	Page
<b>L</b>	
Large Aperture .....	52
Local Focus Areas .....	69
<b>M</b>	
Manual Mode .....	60
Manual Rewind .....	26
MD and MC Series Lenses .....	114
ME .....	88
<b>N</b>	
Neutral Density (ND) Filter .....	65
Night Scenes .....	45
<b>S</b>	
Shutter Priority .....	58
Shutter Release Priority .....	106
Shutter Speed .....	58
Small Aperture .....	52
Spot Focus Area .....	68
<b>T</b>	
Test Fire .....	98
TTL Flash Metering .....	93
<b>P</b>	
PA mode .....	63
Pre-flash Metering .....	92, 93
Ps mode .....	64
<b>Q</b>	
Quartz-date .....	100
<b>R</b>	
Red-eye Reduction .....	38
Remote Control .....	49
Remote Cord .....	81
<b>W</b>	
Wide Focus Frame .....	67
WL .....	95
3600HS(D) .....	91, 92
5600HS(D) .....	91, 92

**MEMO**



<b>Minolta Co., Ltd.</b>	<b>3-13, 2-Chome, Azuchi-Machi, Chuo-Ku, Osaka 541-8556, Japan</b>
<b>Minolta Europe GmbH</b> Reparatur/Repair	Minoltaring 11, D-30855 Langenhagen, Germany Senator-Helmken-Strasse 1, D-28197 Bremen, Germany
<b>Minolta France S.A.</b>	365 Route de Saint-Germain, F-78420 Carrières-Sur-Seine, France
<b>Minolta (UK) Limited</b>	7 Tanners Drive, Blakelands, Milton Keynes, MK14 5BU, England
<b>Minolta Austria Ges. m.b.H.</b>	Amalienstrasse 59-61, A-1131 Wien, Austria
<b>Minolta Camera Benelux B.V.</b> Belgian Branch	Zonnebaan 39, P.O. Box 6000, NL-3600 HA Maarssen, The Netherlands Prins Boudewijnlaan 1, B-2550 Kontich, Belgium
<b>Minolta (Schweiz) AG</b>	Riedstrasse 6, CH-8953 Dietikon, Switzerland
<b>Minolta Svenska AB</b> Finnish Branch	Albygatan 114, S-171 54 Solna, Sweden Niittykatu 6 PL 37, SF-02201 Espoo, Finland
<b>Minolta Portugal Limitada</b>	Av. do Brasil 33-A, P-1700 Lisboa, Portugal
<b>Minolta Corporation</b>	101 Williams Drive, Ramsey, New Jersey 07446, U.S.A.
<b>Minolta Canada Inc.</b>	369 Britannia Road East, Mississauga, Ontario L4Z 2H5, Canada
<b>Minolta Hong Kong Limited</b>	Room 208, 2/F, Eastern Center, 1065 King's Road, Quarry Bay, Hong Kong
<b>Minolta Singapore (Pte) Ltd.</b>	10, Teban Gardens Crescent, Singapore 608923
<b>Shanghai Minolta Optical Products Co., Ltd.</b>	368 Minolta Road, Songjiang, Shanghai, China

©2002 Minolta Co., Ltd. under the Berne Convention and  
Universal Copyright Convention



9222-2164-11 P-B206  
Printed in Japan

## Free Manuals Download Website

<http://myh66.com>

<http://usermanuals.us>

<http://www.somanuals.com>

<http://www.4manuals.cc>

<http://www.manual-lib.com>

<http://www.404manual.com>

<http://www.luxmanual.com>

<http://aubethermostatmanual.com>

Golf course search by state

<http://golfingnear.com>

Email search by domain

<http://emailbydomain.com>

Auto manuals search

<http://auto.somanuals.com>

TV manuals search

<http://tv.somanuals.com>