

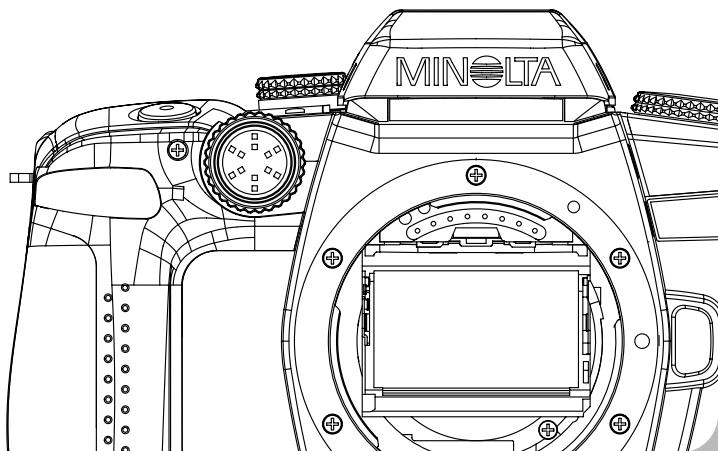

KONICA MINOLTA

# DYNAX 60 MAXXUM 70



**E** INSTRUCTION MANUAL

Download from [www.Somanuals.com](http://www.Somanuals.com). All Manuals Search And Download.

# FOR PROPER AND SAFE USE

Read and understand all warnings and cautions before using this product.

## **WARNING**

Using batteries improperly can cause them to leak harmful solutions, overheat, or explode which may damage property or cause personal injury. Do not ignore the following warnings:

- Only use the batteries specified in this instruction manual.
- Do not install the batteries with the polarity (+/-) reversed.
- Do not use batteries which show wear or damage.
- Do not expose batteries to fire, high temperatures, water, or moisture.
- Do not attempt to short or disassemble batteries.
- Do not store batteries near or in metallic products.
- Do not mix batteries of different types, brands, or ages.
- Do not use leaking batteries. If fluid from the batteries enters your eye, immediately rinse the eye with plenty of fresh water and contact a doctor. If fluid from the batteries makes contact with your skin or clothing, wash the area thoroughly with water.
- Tape over lithium battery contacts to avoid short-circuiting during disposal; always follow local regulations for battery disposal.
- Do not disassemble this product. Electric shock may cause injury if a high voltage circuit inside the product is touched. Take the product to a Konica Minolta service facility when repairs are required.

## **WARNING**

- Immediately remove the batteries and discontinue use if the camera is dropped or subjected to an impact in which the interior, especially the flash unit, is exposed. The flash has a high voltage circuit which may cause an electric shock resulting in injury. The continued use of a damaged product or part may cause injuries.
- Keep batteries or small parts that could be swallowed away from infants. Contact a doctor immediately if an object is swallowed.
- Store this product out of reach of children. Be careful when around children, not to harm them with the product or parts.
- Do not fire the flash directly into the eyes. It may damage eyesight.
- Do not fire the flash at vehicle operators. It may cause a distraction or temporary blindness which may lead to an accident.
- Do not look at the sun or strong light sources directly through the viewfinder or lens. It may damage your eyesight or cause blindness.
- Do not expose this product to liquids or operate this product with wet hands. If liquid enters the product, immediately remove the batteries and discontinue use. The continued use of a product exposed to liquids may cause damage or injury through fire or electric shock.
- Do not use the product near inflammable gases or liquids such as gasoline, benzene, or paint thinner. Do not use inflammable products such as alcohol, benzene, or paint thinner to clean the product. The use of inflammable cleaners and solvents may cause an explosion or fire.
- If the product emits a strange odor, heat, or smoke, discontinue use. Immediately remove the batteries taking care not to burn yourself. The continued use of a damaged product or part may cause injuries.
- Take the product to a Konica Minolta service facility when repairs are required.

## CAUTION

- Do not point the product directly at the sun. If sunlight is focused on an inflammable surface, a fire may result. Replace the lens cap when the product is not in use.
- Do not use or store the product in a hot or humid environment such as the glove compartment or trunk of a car. It may damage the product and batteries which may result in burns or injuries caused by heat, fire, explosion, or leaking battery fluid.
- If batteries are leaking, discontinue use of the product.
- Do not fire the flash while it is in contact with people or objects. The flash unit discharges a large amount of energy which may cause burns.
- Do not apply pressure to the data panel. A damaged panel may cause injury, and the liquid from the panel may cause inflammation. If liquid from the panel makes contact with skin wash the area with fresh water. If liquid from the panel comes in contact with the eyes, immediately rinse the eyes with plenty of water and contact a doctor.

Konica Minolta is a trademark of Konica Minolta Holdings, Inc. Dynax and Maxxum are trademarks of Konica Minolta Photo Imaging, Inc.

# TABLE OF CONTENTS

Thank you for purchasing this camera. Please take time to read this manual so that you can enjoy all the features of your new camera.

Names of parts .....	8
Data panel .....	10
Viewfinder .....	11
Getting started .....	12
Attaching the strap .....	12
Attaching a lens .....	13
Removing a lens .....	13
Installing batteries .....	14
Battery condition indicator .....	15
Loading film .....	16
Diopter adjustment .....	17
Setting the date and time - Date model .....	18
Changing batteries - Date model .....	19
Basic operation .....	20
Turning on the camera .....	20
Handling the camera .....	20
Taking a picture .....	21
Focus signals .....	22
Special focusing situations .....	22
Focus lock .....	23
Flash modes .....	24
Flash signals .....	25
Flash range .....	25
Subject programs .....	26
Film rewind .....	28
Manual rewind .....	29
A short guide to photography .....	30
What is a stop? What is an Ev? .....	31
Advanced operation .....	32
Mode dial .....	32
About full-auto program .....	33
Program - P .....	34
Aperture priority - A .....	35
Shutter priority - S .....	36
About shutter speeds .....	37
What is an f-number? .....	37
Manual exposure - M .....	38

Metering in manual exposure .....	39
Bulb exposures .....	40
Attaching the eyepiece cap .....	41
Optional viewfinder accessories .....	41
Exposure compensation .....	42
Depth of field preview .....	43
AE lock button .....	44
About slow sync. ....	45
AF button .....	46
Manual focus - MF .....	48
Function dial .....	49
Audio signals .....	49
Drive modes .....	50
Continuous-advance notes .....	51
Self-timer notes .....	51
Remote control notes .....	52
Multiple exposures .....	53
Exposure bracketing .....	54
AF modes .....	56
Manual ISO .....	57
Metering modes .....	58
Red-eye reduction .....	59
Wireless/Remote flash .....	60
Wireless/Remote flash notes .....	62
Date imprinting - Date model .....	63
Custom functions .....	64
Custom 1 - AF/shutter priority .....	66
Custom 2 - Film rewind .....	66
Custom 3 - Film leader .....	66
Custom 4 - DX memory .....	67
Custom 5 - Shutter lock (film) .....	67
Custom 6 - Focus-hold button .....	67
Custom 7 - Program shift .....	68
Custom 8 - AF button .....	69
Custom 9 - AEL button .....	70
Custom 10 - AF illuminator .....	70
Custom 11 - Flash metering .....	71
Custom 12 - Focus area illumination .....	72
Custom 13 - Shutter lock (lens) .....	72
Custom 14 - Shutter lock (back) .....	72
Custom 15 - Date format (Date model) .....	73
Custom function reset .....	73

Accessory notes.....	74
Lens notes.....	74
Accessory flash notes.....	76
High Speed Sync. (HSS).....	77
Wireless Controller IR-1N.....	77
Troubleshooting.....	78
Care and storage.....	80
Operating conditions.....	80
Storage.....	80
Cleaning.....	81
Before important events.....	81
Questions and service.....	81
Technical specifications.....	82

This device complies with Part 15 of the FCC Rules. Operation is subject to the following two conditions: (1) This device may not cause harmful interference, and (2) this device must accept any interference received, including interference that may cause undesired operation. Changes or modifications not approved by the party responsible for compliance could void the user's authority to operate the equipment. This equipment has been tested and found to comply with the limits for a Class B digital device, pursuant to Part 15 of the FCC Rules. These limits are designed to provide reasonable protection against harmful interference in a residential installation. This equipment generates, uses and can radiate radio frequency energy and, if not installed and used in accordance with the instructions, may cause harmful interference to radio communications. However, there is no guarantee that interference will not occur in a particular installation. If this equipment does cause harmful interference to radio or television reception, which can be determined by turning the equipment off and on, the user is encouraged to try to correct the interference by one or more of the following measures:

- Reorient or relocate the receiving antenna.
- Increase the separation between the equipment and the receiver.
- Connect the equipment to an outlet on a circuit different from that to which the receiver is connected.
- Consult the dealer or an experienced radio/TV technician for help.

This Class B digital apparatus complies with Canadian ICES-003.



This mark on your camera certifies that this camera meets the requirements of the EU (European Union) concerning interference causing equipment regulations. CE stands for Conformité Européenne (European Conformity).

# NAMES OF PARTS

\*This camera is a sophisticated optical instrument. Care should be taken to keep these surfaces clean. Please read the care and storage instructions in the back of this manual (p. 80).

Self-timer lamp / Remote-control receiver (p. 51, 52)

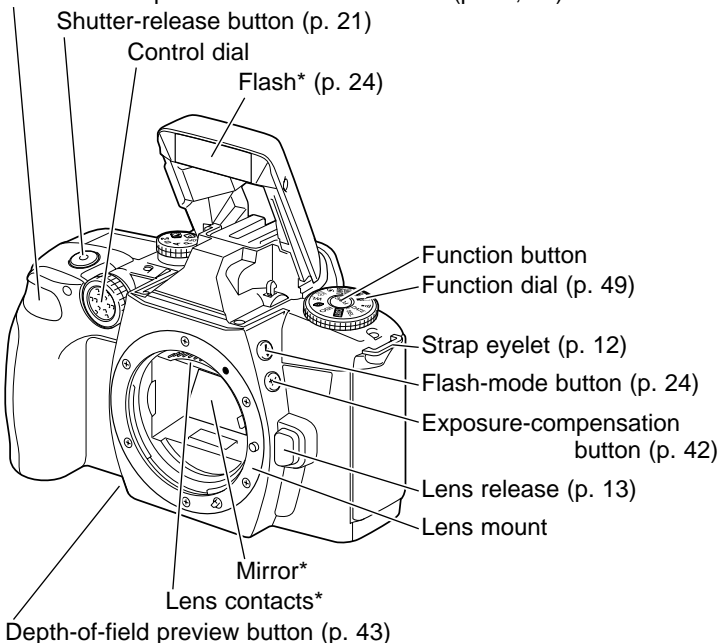

The battery-chamber door (p. 14) and tripod socket are located on the bottom of the body.



Eyepiece cup

Accessory shoe

Mode dial / Main switch (p. 32, 20)

Data panel

Strap eyelet (p. 12)

Manual-rewind button  
(p. 29)

Back-cover release (p. 16)

Viewfinder\*

Film window

Focus-mode button (p. 48)

AE lock button (p. 44)

AF button (p. 46)

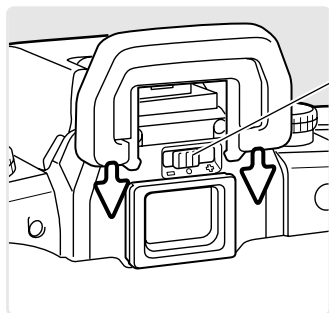

Diopter-adjustment slider (p. 17)

Slide the supplied eyepiece cup  
around the viewfinder frame.

# DATA PANEL

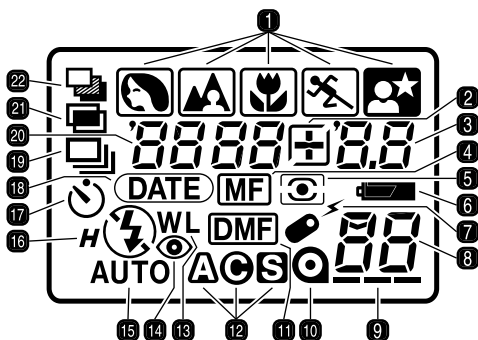
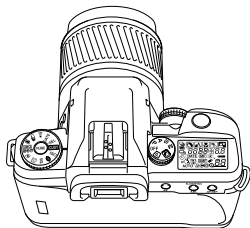

1. Subject program indicators (p. 26)
2. Exposure-compensation indicator (p. 42)
3. Aperture display
4. Manual-focus indicator (p. 48)
5. Metering-mode indicator (p. 58)
6. Battery-condition indicator (p. 15)
7. Remote-control indicator (p. 50, 52)
8. Frame counter
9. Film-transport signals
10. Cartridge mark
11. Direct Manual Focus indicator (p. 56)
12. AF-mode indicators (p. 56)
13. Wireless / Remote flash indicator (p. 60)
14. Red-eye reduction indicator (p. 59)
15. Flash-mode indicators (p. 24)
16. High-speed sync. indicator (p. 77)
17. Self-timer indicator (p. 51)
18. Date-imprinting indicator (p. 63) (Date model)
19. Single-frame / Continuous advance indicator (p. 50)
20. Shutter-speed display
21. Multiple-exposure indicator (p. 53)
22. Exposure-bracketing indicator (p. 54)

# VIEWFINDER

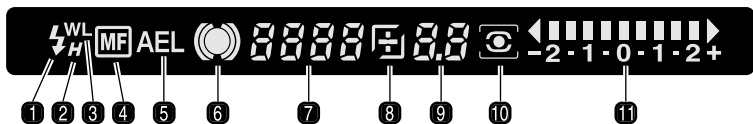
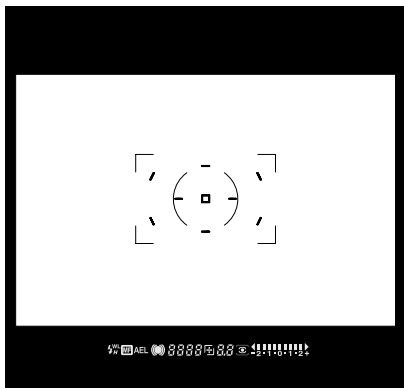
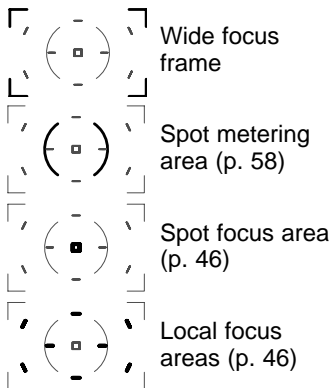

1. Flash indicator (p. 25)
2. High-speed sync. indicator (p. 77)
3. Wireless / Remote flash indicator (p. 60)
4. Manual focus indicator (p. 48)
5. AE lock indicator (p. 44)
6. Focus signal (p. 22)
7. Shutter-speed display
8. Exposure-compensation indicator (p. 42)
9. Aperture display
10. Metering-mode indicator (p. 58)
11. Ev scale (p. 39, 45)

The spot focus area and local focus areas are briefly illuminated when the focus is locked to indicate the point of focus.

# GETTING STARTED

## ATTACHING THE STRAP

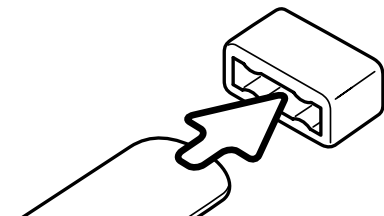

With the visible protrusions on the inside of the holder ring oriented as shown, pass the tip of the strap through the ring.

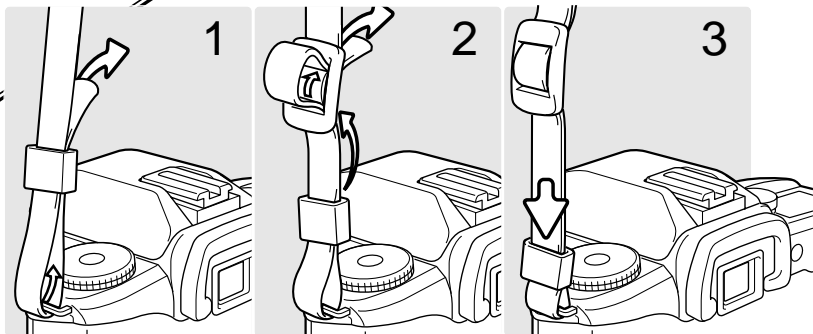

Pass the tip of the strap through the camera's strap eyelet from below and then the holder ring (1). Attach the strap so the tip comes between the strap and the camera.

Thread the tip of the strap through the inside of the buckle and pull to tighten (2). Leave some slack in the camera strap so the tip may be threaded through the buckle easily.

Push the holder ring toward the strap eyelet to secure the strap to the camera (3). Repeat with the other end of the camera strap.

## ATTACHING A LENS

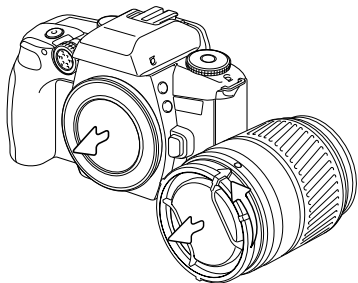

This camera uses interchangeable lenses. See page 74 for compatible lenses. Never touch the inside of the camera, especially the lens contacts and mirror.

Remove the body and rear lens caps. The arrow on the rear lens cap must be aligned to the lens mounting index.

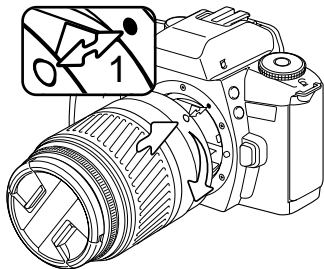

Align the red mounting index on the lens and camera body (1). Carefully insert the lens into the mount, then turn it clockwise until it clicks into the locked position. Do not insert the lens at an angle. If it does not fit, check its orientation with the index marks. Never force the lens.

## REMOVING A LENS

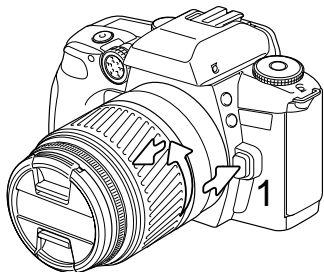

Press the lens release all the way in (1) and turn the lens counter-clockwise until it stops. Carefully remove the lens.

Replace the caps on the lens and attach the body cap or another lens to the camera.

## INSTALLING BATTERIES

The camera requires two 3V CR2 lithium batteries to operate. Read the proper and safe use section on page 2 before using the batteries. When changing batteries, confirm the mode dial is in the off position.

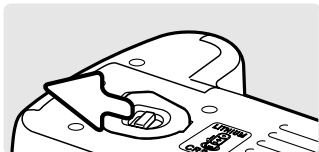

Slide the battery-chamber release in the direction shown, and open the door. Setting the camera down with the battery-chamber door open may damage the camera.

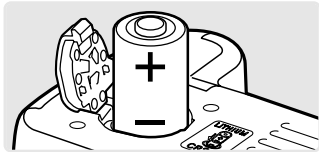

Insert the batteries as indicated on the diagram next to the battery chamber-door. Confirm the positive and negative battery terminals are oriented correctly.

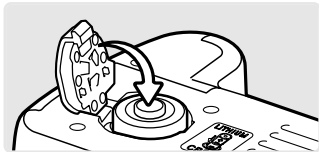

Push the battery-chamber door closed until it clicks into place.

### Date Model

The date display will blink when the camera is turned on until the clock and calendar are set. To set the camera's clock and calendar, see page 18.

The clock and calendar are powered by the camera batteries. If the batteries are removed, the date and time are reset, and the date-imprinting function is disabled. To save the date and time when changing batteries, see page 19.

## BATTERY-CONDITION INDICATOR

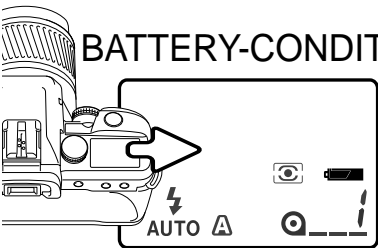

The camera has a battery-condition indicator. When the camera is on, the indicator appears on the data panel. If the data panel is blank, the batteries may be exhausted or installed incorrectly.



**Full-battery indicator** - power is sufficient for all camera operations.

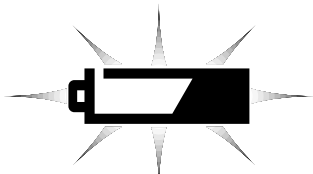

**Low-battery indicator** - indicator blinks. All functions are operational, but the batteries need to be replaced soon. Flash recycling time may be slow.

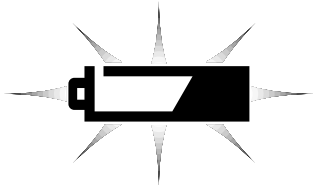

**Low-battery warning** - indicator blinks and no other indicators appear on the data panel. Power is insufficient for camera operation and the shutter will not release. Replace the batteries.

Occasionally, the battery-condition indicator can give a false low-battery warning, even though power is sufficient for operation. Turn the camera on and off a few times to reset the display.

## LOADING FILM

Always load or remove the film under subdued light to reduce the chances of fogging. The camera automatically sets the correct film speed (ISO) with DX-coded film. If non-DX-coded film is used, the camera will use the previous roll's film speed. See page 57 to set the film speed manually.

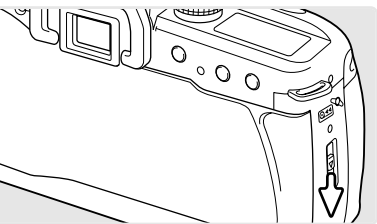

Slide the back-cover release down to open the camera.

Never touch the shutter curtain with your fingers or the film leader. The curtain's precision design is extremely sensitive to pressure.

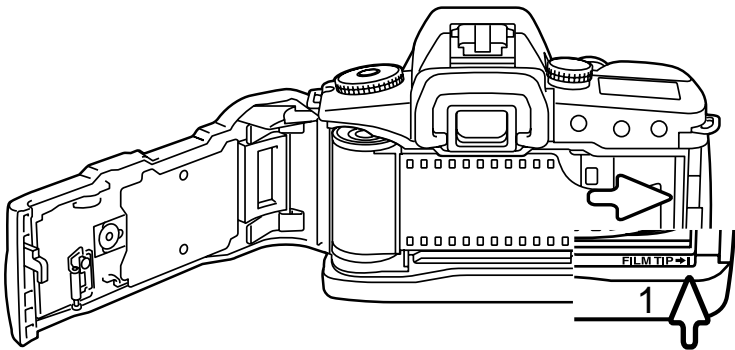

Insert the film cartridge into the film chamber. Extend the leader between the guide rails to the film-tip index mark (1). If the film tip extends beyond the index mark, take the cartridge out and rewind the excess film back into the cartridge.

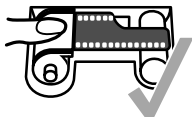

Hold the film cartridge down so that the film lays flat.

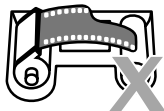



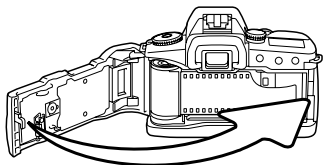

Close the back cover. The camera automatically advances the film to the first frame. Take care not to catch the strap when closing the cover.

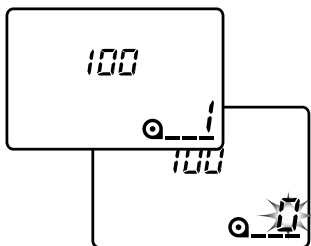

If the film is loaded correctly, the frame counter indicates the first frame. The film speed (ISO) is displayed on the data panel for 5 seconds.

If the film is loaded incorrectly, 0 blinks in the frame counter. Reload the film.

## Camera Notes

Do not use Polaroid Instant 35mm film; winding problems may occur. Infrared film cannot be used as the camera's frame counter sensor will fog the film. No more than 40 exposures can be taken on one roll. When using 72-exposure film, the camera will rewind the roll after the 40th exposure.

## DIOPTRER ADJUSTMENT

The viewfinder has an adjustable diopter. It can be adjusted between  $-2.0$  and  $+1.0$  diopter.

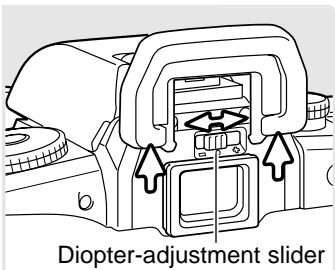

Diopter-adjustment slider

Carefully slide the eyepiece cup from around the viewfinder frame by pushing on each side of the cup.

While looking through the viewfinder, slide the diopter-adjustment slider until the image of the focus frame is sharp. Replace the eyepiece cup.

## SETTING DATE AND TIME - DATE MODEL

The camera's clock and calendar need to be set for date imprinting. The date blinks on the data panel when the camera is turned on if the clock and calendar are not set or have reset because the batteries are exhausted.

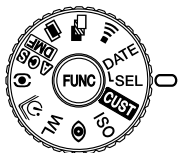

Turn the function dial to the date select position (SEL); the calendar is displayed on the data panel. The date format is year, month, day, and can be changed, see page 64.

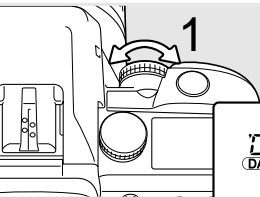

Turn the control dial (1) to select the date and time registers; the selected register blinks.

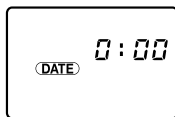
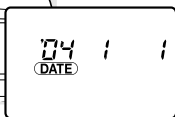

calendar

Clock

To change the selected register, press and hold the function button (2) and turn the control dial (3). The camera uses a 24 hour clock so 14:00 is 2pm. The calendar is automatic from the year 2003 to 2039.

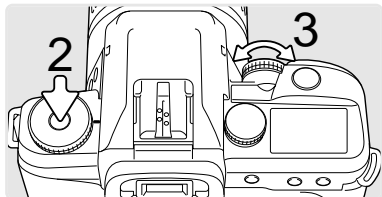

Continue until the calendar and clock are set. Turn the function dial to any position except DATE, SEL, or CUST to view the standard data panel display. See page 63 on how to use the date imprinting function.

## CHANGING BATTERIES - DATE MODEL

When the batteries have been removed, the camera's built-in clock will stop. The following procedure stores the current time and date when the batteries are changed.

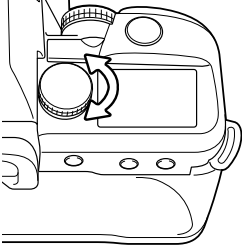

Turn the camera on and off with the mode dial. The camera stores the current date and time in a memory register each time the camera is turned off or on.

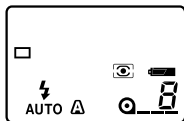

Change the batteries as described on page 14. Turn the camera on. If normal data panel display appears, the clock and calendar did not reset.

If the date blinks on the data panel when the camera is turned on, the clock and calendar reset. See the facing page on how to set the date and time.

# BASIC OPERATION

This section covers the basic operation of the camera. Thoroughly familiarize yourself with the operations in this section before moving on.

## TURNING THE CAMERA ON

To turn on the camera, simply turn the mode dial to the appropriate mode (1). The basic operation section assumes that the full-auto program mode is selected - P enclosed in a circle. The full-auto program mode simplifies the picture taking process. For more on this and other modes, see page 32.

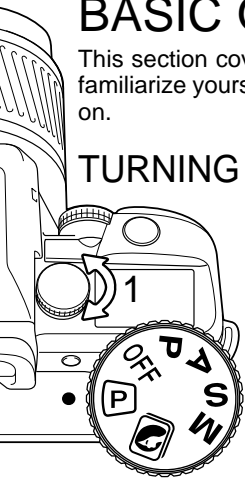

## HANDLING THE CAMERA

Grip the camera firmly with your right hand, while supporting the lens with your left. Keep your elbows at your side and your feet shoulder-width apart to hold the camera steady. Keep the camera strap around your neck or wrist in the event you accidentally drop the camera.

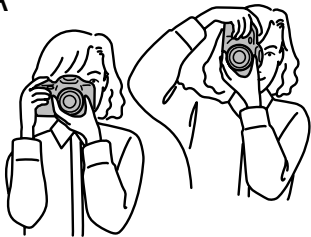

The use of a tripod is recommended when using the camera in low-light situations or when using telephoto lenses. If a tripod is not available, lean against a wall or rest your elbows on a solid surface to steady the camera.

# TAKING A PICTURE



Place the subject in the wide focus frame. If using a zoom lens, rotate the zooming ring to frame the subject.

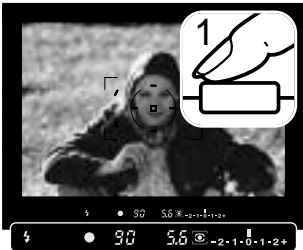

Press the shutter release button partway down to activate the autofocus and exposure systems (1). The viewfinder focus signal (p. 22) confirms focus and the spot or local focus area is briefly illuminated to indicate the point of focus. If the focus signal blinks, repeat the procedure.

Flash indicator  
Focus signal  
Shutter speed  
Aperture

If the flash is required for the exposure, it raises automatically and the flash indicator appears in the viewfinder (p. 25). In low-light conditions, the flash acts as an AF illuminator (p. 70).

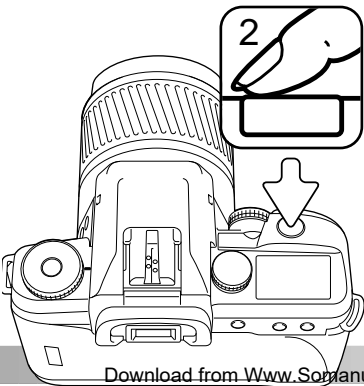





The shutter speed and aperture used for the exposure are displayed in the viewfinder and on the data panel.

Press the shutter-release button all the way down to take the picture (2). When taking a picture, press the shutter-release button gently so not the shake the camera during the exposure.

# FOCUS SIGNALS

The viewfinder focus signal indicates the status of the autofocus system. Focusing time can be longer with macro or telephoto lenses, or in low light conditions.



-  Focus locked.
-  Focus is confirmed (Continuous AF - p. 56).
-  Indicator blinks - cannot focus. The shutter is locked.
-  Focusing (Continuous AF). The shutter is locked.

When the camera cannot focus, the subject may be too close or a special focus situations may be preventing the system from focusing. Use focus lock or manual focus (p. 48).

Autofocus priority and shutter-release priority can be specified with custom function 1 (p. 64).

## SPECIAL FOCUSING SITUATIONS

The camera may not be able to focus in the following situations. Use focus lock or manual focus (p. 48).

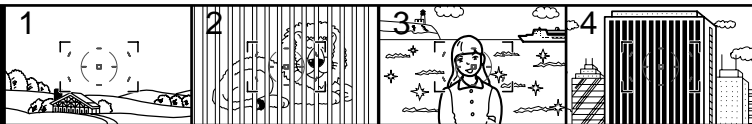

1. The subject within the focus frame is very bright, or low in contrast.
2. Two subjects at different distances overlap in the focus frame.
3. The subject is near a very bright object or area.
4. The subject composed of alternating light and dark lines completely fills the focus frame.

# FOCUS LOCK

Focus-lock is used for off-center subjects outside the focus frame. Focus lock can also be used when a special focusing situation prevents the camera from focusing by allowing the camera to be focused on a object at the same distance as the subject.



Center your subject in the wide focus frame, then press the shutter-release button partway down to lock focus (1).

The focus is locked when focus signal appears in the viewfinder. If the signal blinks, the camera was unable to focus; repeat the procedure.

The exposure is locked with focus. Releasing the shutter button cancels focus lock.



Continue to hold the shutter-release button partway down and compose the picture.

Press the shutter-release button all the way down (2) to take the picture.

## FLASH MODES

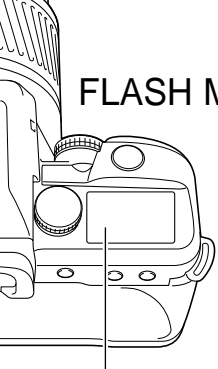

The built-in flash is designed to be used with lenses with focal lengths from 28mm or longer. When using lenses shorter than 28mm, the corners of the image will not be fully illuminated. Remove the lens hood to prevent lens shadowing, see page 75. The shutter will not release while the flash is charging. Push down the built-in flash when the camera is not in use.



**Autoflash** - the built-in-flash pops up automatically when flash illumination is required. Only available with full-auto program, program, and subject programs (p. 32).



**Fill flash** - the flash fires with each exposure regardless of the ambient light. Fill flash can be used to reduce harsh shadows caused by strong direct light or sunshine.



**Flash cancel** - the flash will not fire. Used when flash photography is prohibited, natural light is desired to illuminate the subject, or the subject is beyond the flash range.

To change the flash mode with full-auto program, program, and subject programs, press and hold the flash-mode button (1) and turn the control dial (2) until the appropriate mode is displayed on the data panel.

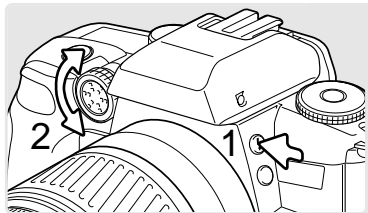

When using aperture-priority, shutter-priority, or manual exposure mode, the flash is set to flash cancel. To use fill flash, press the flash-mode button to raise the flash. For accessory-flash information, see page 76.



# FLASH SIGNALS

The viewfinder flash signal indicate the status of the flash.



 Signal steady - flash charged and ready to fire.

 Signal blinking - flash output was sufficient for exposure.

If the flash signal does not blink after taking the picture, the subject was not within the flash range.

## FLASH RANGE

The range of the built-in flash depends on the speed of the film and the aperture used for the exposure. The subject must be within the flash range specified in the table below to be correctly exposed.

Aperture	ISO 100	ISO400
f/2.8	1.0 ~ 5.6m / 3.3 ~ 18.4 ft.	1.0 ~ 11m / 3.3 ~ 36 ft.
f/3.5	1.0 ~ 4.5m / 3.3 ~ 14.8 ft.	1.0 ~ 9.0m / 3.3 ~ 29.6 ft.
f/4.0	1.0 ~ 4.0m / 3.3 ~ 13.1 ft.	1.0 ~ 8.0m / 3.3 ~ 26.2 ft.
f/5.6	1.0 ~ 2.8m / 3.3 ~ 9.2 ft.	1.0 ~ 5.6m / 3.3 ~ 18.4 ft.

### Camera Notes

With full-auto program, program, and subject programs, fill flash can be used with specific single exposures. Press and hold the flash-mode button while pressing the shutter-release button to make the exposure; the flash pops up automatically.

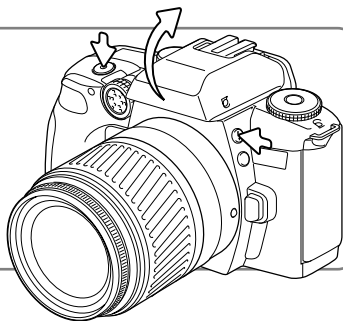

## SUBJECT PROGRAMS

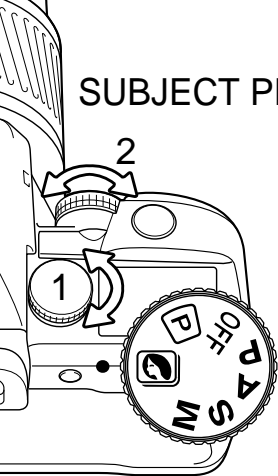

Subject programs optimize the camera system for specific conditions or subjects. Five subject programs are available.

Turn the mode dial (1) to the subject program position.

Use the control dial (2) to select the appropriate program; the active program is displayed at the top of the data panel.

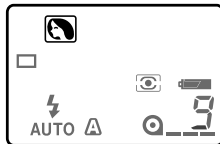

Not all camera functions can be selected with subject programs.



**Portrait** - optimized to create sharp images of the subject with a soft background. Most portraits look best at a telephoto setting; the long focal length does not exaggerate facial features and the shallow depth of field separates the subject from the background. Use fill flash (p. 24) with strong direct sunlight or backlight to reduce harsh shadows.



**Landscape** - optimized to create sharp landscape photographs, while maintaining a shutter speed fast enough to prevent blurring from camera shake. For best results zoom to a wide-angle setting or use a wide-angle lens. Include a foreground subject or detail to create a feeling of depth in the picture.

When taking a portrait within a landscape, use fill flash (p. 24) with strong direct sunlight or backlight to reduce harsh shadows, see flash range on page 25. The flash will have no effect on the landscape. The use of a tripod is recommended.



**Close-up** - the camera selects the optimum aperture and shutter speed combination to photograph at short object distances. For best results use a macro lens or a macro capable zoom lens. Focusing time can be longer with macro lenses. The use of a tripod is recommended.

The built-in flash will overexpose subjects closer than 1.0m (3.3 ft.). Use flash cancel. At close distances, the lens or lens hood may block the flash, creating a shadow at the bottom of the image. The use of an accessory flash is recommended.



**Sports Action** - the camera uses the fastest possible shutter speed to stop motion and continually adjusts focus to track the subject. The use of fast film is recommended. When the subject is not within the flash range, use flash cancel (p. 24). Mount the camera on a tripod or monopod when using telephoto lenses.



**Night Portrait** - for photographs of people in low-light conditions. The camera balances the ambient light exposure with the flash exposure so the background appears in the image. The use of fast film is recommended. Ask the subject not to move after the flash burst as the shutter may still be open for the background exposure. Use a tripod to reduce camera shake.

To photograph a landscape or scene at night, set the flash mode to flash cancel (p. 24). Dark night scenes may prevent the AF system from focusing, use manual focus (p. 48). Night scenes tend to be better at twilight rather than in the darkness of night. The faint light in the early evening sky adds detail to the shadows of the scene.

## FILM REWIND

After the last frame on the roll of film has been exposed, the camera rewinds the film automatically. The frame counter counts down during rewind. Do not turn the focusing ring when the film is rewinding.

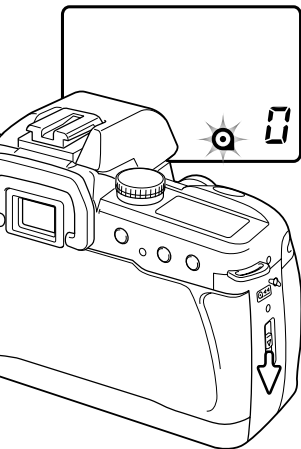

Wait until the film is completely rewound; zero (0) is displayed on the frame counter and the cartridge mark blinks on the data panel to indicate the camera can be opened to remove the film.

Slide the back-cover release down to open the camera and remove the film. Close the back cover taking care not to catch the strap. To load a new roll of film, see page 16.

Although more pictures than specified on the film package may be taken, the film processor may not print more than the number specified on the film cartridge or the last frame may be cropped.

### Camera Notes

Custom functions control film rewind (p. 64). Custom 2 disables automatic rewind. Custom 3 specifies if the film leader is completely rewound into the cartridge or left out.

## MANUAL REWIND

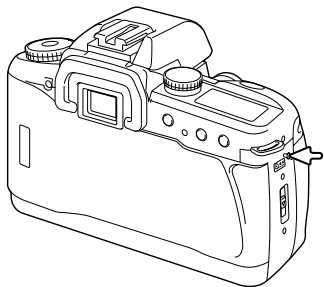

The film can be rewound manually before the roll is finished.

Gently press the manual-rewind button using a pen to begin rewinding the film. Only use blunt objects. Sharp objects may damage the camera.

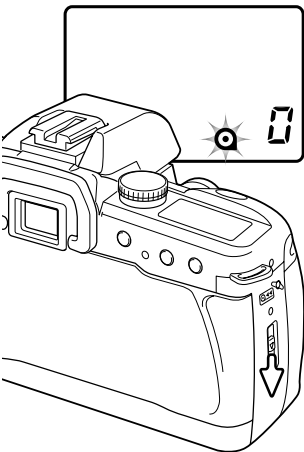

Wait until the film is completely rewound; zero (0) is displayed on the frame counter and the cartridge mark blinks on the data panel to indicate the camera can be opened to remove the film.

Slide the back-cover release down to open the camera and remove the film. Close the back cover taking care not to catch the strap. To load a new roll of film, see page 16.

### Camera Notes

The film-chamber lock prevents the camera from being opened while a roll of film is loaded. The lock automatically releases when the film is rewound.

# A SHORT GUIDE TO PHOTOGRAPHY

Photography can be a rewarding pursuit. It is a broad and disciplined field that can take years to master. But the pleasure in making photographs and the joy of capturing a magical moment cannot be compared. The guide is an introduction to some basic photographic principles.

The lens aperture controls not only exposure, but also depth of field; the area between the closest object in focus and the furthest object in focus. The larger the aperture value, the greater the depth of field and the longer the shutter speed needed to make the exposure. The smaller the aperture value, the shallower the depth of field and the faster the shutter speed needed to make the exposure. Usually landscape photographs use a large depth of field (large aperture value) to keep the foreground and background in focus, and portraits use a shallow depth of field (small aperture value) to separate the subject from the background.

Depth of field also changes with focal length. The shorter the focal length, the greater the depth of field; the longer the focal length, the shallower the depth of field.

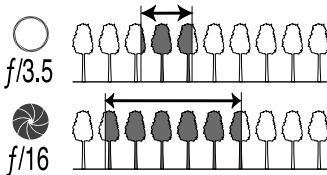



The shutter controls not only exposure, but also the ability to stop motion. Fast shutter speeds are used in sport photography to stop action. Slow shutter speeds can be used to show the flow of motion such as water cascading over a waterfall. The use of a tripod is recommended with slow shutter speeds.

## WHAT IS A STOP? WHAT IS AN EV?

The term “stop” comes from the name of aperture plates in old lenses. Ev stands for exposure value. A change of one stop or one Ev adjusts the exposure by a factor of two.

+3 stops	+3.0 Ev	8X as much light
+2 stops	+2.0 Ev	4X as much light
+1 stop	+1.0 Ev	2X as much light
Calculated exposure		
-1 stop	-1.0 Ev	1/2 as much light
-2 stops	-2.0 Ev	1/4 as much light
-3 stops	-3.0 Ev	1/8 as much light





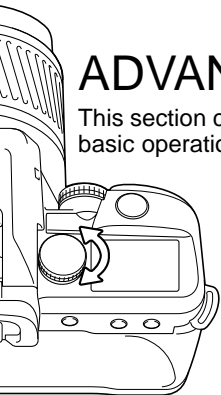

# ADVANCED OPERATION

This section covers the advanced features of the camera. Read the basic operation section before moving on.



## MODE DIAL

The mode dial give direct access to the main exposure modes in the camera. It also acts as the camera's main switch. Simply turn the dial to the appropriate position.

-  Subject programs - to optimize the camera settings based on specific subjects or situations (p. 26).
-  Full-auto program - camera systems are completely automated for effortless picture taking (p. 33).
-  Off - to turn the camera off.
-  Program - aperture and shutter speeds are set automatically by the camera (p. 34).
-  Aperture priority - shutter speed is set by the camera depending on the aperture set by the photographer (p. 35).
-  Shutter priority - aperture is set by the camera depending on the shutter speed set by the photographer (p. 36).
-  Manual exposure - the photographer sets both the shutter speed and aperture required for the exposure (p. 38).



## ABOUT FULL-AUTO PROGRAM

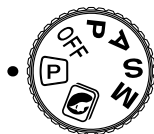

Full-auto program completely automates the picture-taking process. If the position of the mode dial is changed, the following are reset:

Flash mode (p. 24)	Autoflash
Focus area (p. 11)	Wide focus frame
Autofocus mode (p. 56)	Auto
Drive mode (p. 50)	Single-frame advance
Metering mode (p. 58)	14-segment
Exposure compensation (p. 42)	0.0
Exposure bracketing (p. 54)	Off
Multiple exposure (p. 53)	Off
Wireless / Remote flash (p. 60)	Off

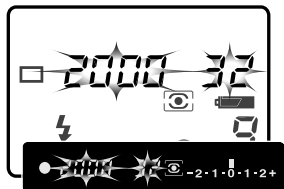

If the required exposure is beyond the shutter speed and aperture range, the shutter speed and aperture displays blink on the data panel and in the viewfinder.

In bright conditions, use a neutral density filter on the lens, load a slower film, or, if using artificial lights, reduce the intensity of the illumination. In dark conditions, use the built-in flash or load a faster film.

### Camera Notes

When the mode dial is turned to the full-auto program or subject-program positions, the program, aperture-priority, shutter-priority, and manual exposure modes are also reset.

## PROGRAM - P



Like full-auto program, program controls both the shutter speed and aperture required for each exposure. The operation is the same as described in the taking-a-picture section on page 21. However, functions set in this mode will not reset when the camera is turned off.

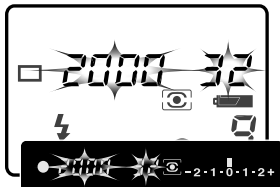

If the required exposure is beyond the shutter speed and aperture range, the shutter speed and aperture displays blink on the data panel and in the viewfinder.

In bright conditions, use a neutral density filter on the lens, load a slower film, or, if using artificial lights, reduce the intensity of the illumination. In dark conditions, use the built-in flash or load a faster film.

Custom function 7 allows the shutter speed and aperture combination to be changed without affecting the total exposure. For more information on program shift, see page 68.

### Camera Notes



If the light levels are outside the metering range of the camera, the metering-mode indicator (p. 58) on the data panel and in the viewfinder blinks. In dark conditions, use the camera flash. Under bright light, use a neutral density filter to control the light level.

## APERTURE PRIORITY - A

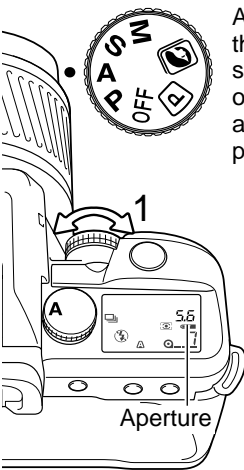

Aperture priority allows the photographer to specify the aperture; the camera sets the appropriate shutter speed for the required exposure. The aperture not only controls exposure, but also depth of field, the area in front of the camera that appears sharp, see page 30.

Turn the control dial (1) to adjust the aperture. The aperture range depends on the lens. The aperture value can be seen on the data panel and in the viewfinder.



Pressing the shutter-release button partway down (2) displays the corresponding shutter speed. Press the shutter-release button all the way down to take the picture.



If the required exposure is beyond the shutter speed range, the shutter-speed display blinks on the data panel and in the viewfinder. Adjust the aperture until the display is steady.

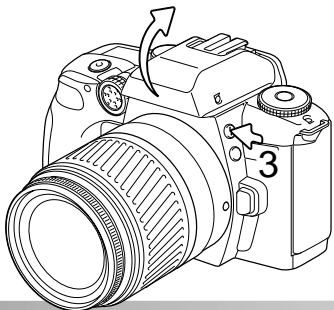

To use fill flash, press the flash-mode (3) button to raise the flash. The shutter speed cannot exceed the flash-sync speed of 1/90 second. If the shutter-speed display blinks, adjust the aperture until the display is steady.

Flash range is dependent on the aperture, see page 25. To cancel the flash, push the flash head down.

# SHUTTER PRIORITY - S

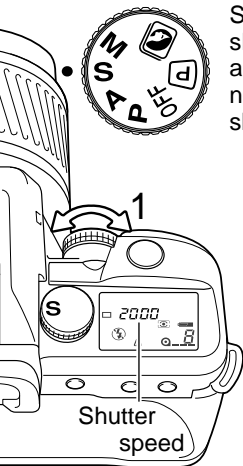

Shutter priority allows the photographer to specify the shutter speed; the camera sets the appropriate aperture for the required exposure. Shutter speeds not only control exposure, but also the apparent sharpness of moving objects, see page 30.

Turn the control dial (1) to adjust the shutter speed between 30 and 1/2000 second. The speeds can be seen on the data panel and in the viewfinder.



Pressing the shutter-release button partway down (2) displays the corresponding aperture. Press the shutter-release button all the way down to take the picture.



If the required exposure is beyond the aperture range, the aperture display blinks on the data panel and in the viewfinder. Adjust the shutter speed until the display is steady.

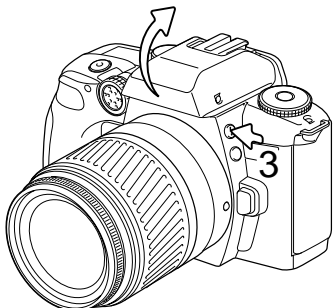

To use fill flash, press the flash-mode (3) button to raise the flash. The shutter speed cannot exceed the flash-sync speed of 1/90 second.

Flash range is dependent on the aperture, see page 25. To cancel the flash, push the flash head down.

## ABOUT SHUTTER SPEEDS

The shutter speed used for each exposure is displayed on the data panel and in the viewfinder. The following notation is used:

125

The reciprocal is used for shutter speeds from 1/2000 second to 1/3 second. 125 is 1/125 second.

1"5  
15"

For shutter speeds of a half a second or longer, a quote mark is used to denote whole seconds. 1"5 is one and a half seconds and 15" is fifteen seconds.

## WHAT IS AN *f*-NUMBER?

An *f*-number indicates the relative aperture of the lens and lets us determine how much light it lets through. But why does the number get bigger when the amount of light decreases? The answer is in the way it is written, *f*/2.0, *f*/8.0. etc. That means the focal length of the lens (*f*) divide by 2 or 8. So a 100mm lens at *f*/2 has a 50mm effective aperture (100/2) and at *f*/8, a 12.5mm effective aperture (100/8). The *f*-number indicates the size of the aperture as a fraction of the focal length of the lens.

The *f*-number series was carefully chosen to make controlling exposures easy. In the chart, the aperture and shutter speed combinations give the exact same exposure. Notice how the shutter speed changes to compensate for the change in aperture.

<i>f</i> /2.8	1/2000s
<i>f</i> /4.0	1/1000s
<i>f</i> /5.6	1/500s
<i>f</i> /8.0	1/250s
<i>f</i> /11	1/125s
<i>f</i> /16	1/60s
<i>f</i> /22	1/30s
<i>f</i> /32	1/15s

## MANUAL EXPOSURE - M



Manual exposure allows the photographer to specify both the shutter speed and aperture for the exposure. For more on aperture and shutter control, see page 30. Bulb exposures can also be made, refer to page 40.

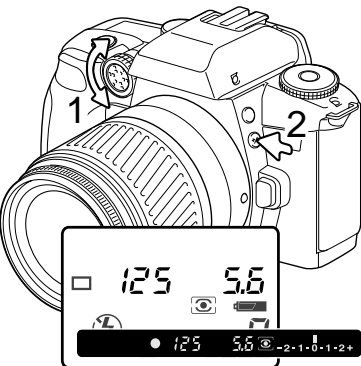

Turn the control dial (1) to adjust the shutter speed between 30 and 1/2000 second.

Press and hold the exposure compensation button (2) and turn the control dial (1) to adjust the aperture. The aperture range depends on the lens. The shutter speed and aperture values are displayed on the data panel. Press the shutter-release button partway down to view the exposure in the viewfinder.

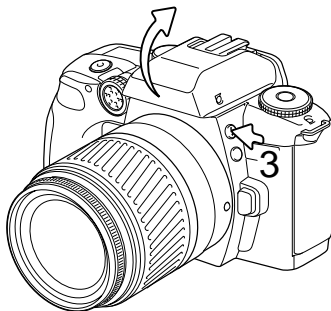

To use fill flash, press the flash-mode (3) button to raise the flash. The flash exposure is controlled automatically by the camera.

The shutter speed cannot exceed the flash-sync speed of 1/90 second. Flash range is dependent on the aperture, see page 25. To cancel the flash, push the flash head down.

# METERING IN MANUAL EXPOSURE



The Ev scale in the viewfinder indicates the difference between the set exposure and the exposure determined by the camera meter. Press the shutter-release button partway down to activate the meter. The scale uses half stop or 0.5Ev increments. For more on stops and Ev, see page 31.



The set exposure is one stop less (-) than the exposure determined by the meter.



The arrow indicates the set exposure is two and a half stops more (+) or less (-) than the exposure determined by the meter.



The blinking arrow indicates the set exposure is three or more stops greater (+) or less (-) than the exposure determined by the meter.

## Konica Minolta History

We believe innovation and creativity is the cornerstone of our success. The Electro-zoom X was an exercise in camera design and was unveiled at Photokina in 1966.



The Electro-zoom X is an aperture-priority SLR with a built-in 30 - 120mm f/3.5 zoom lens. It took twenty 12 X 17mm images on a roll of 16mm film. The shutter button and battery chamber are located in the grip. Only a few prototypes were built making it one of Minolta's rarest camera.

## BULB EXPOSURES

Bulb exposures can be taken in the manual-exposure mode (p. 38). Bulb allows the shutter to remain open for as long as the shutter-release button is pressed. The camera's exposure meter cannot calculate bulb exposures; a separate light meter is recommended.

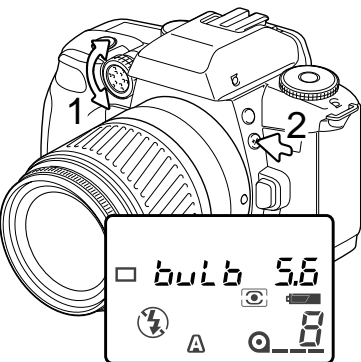

In manual-exposure mode, use the control dial (1) to decrease the shutter speed until bulb appears in the shutter-speed display on the data panel.

Press and hold the exposure-compensation button (2) and turn the control dial to select the aperture.

Press and hold the shutter-release button for the duration of the exposure. The optional remote control RC-3 can be used open and close the shutter (p. 52).

A tripod is recommended for bulb exposures. If the light level prevents the camera from focusing, use manual focus (p. 48).



## ATTACHING THE EYEPiece CAP

The supplied eyepiece cap prevents light from entering through the viewfinder and affecting the exposure meter or fogging the film when using the self-timer or remote control or during long exposures.

Carefully slide the eyepiece cap from around the viewfinder frame by pushing on each side of the cap.

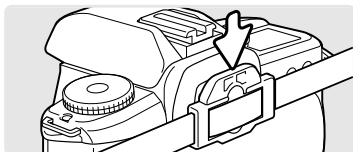
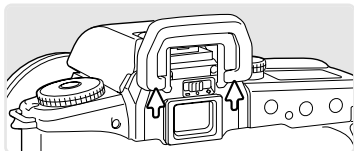

Slide the eyepiece cap over the viewfinder. The cap should be attached to the camera strap to prevent loss. Replace the eyepiece cup after the exposure.

## OPTIONAL VIEWFINDER ACCESSORIES

The Angle Finder V<sub>N</sub> and Magnifier V<sub>N</sub> can be used with this camera. The Angle Finder makes using the camera at low angles easier. The Magnifier enlarges the center of the viewfinder image for critical focusing especially for macro photography.

Eyepiece Corrector 1000 series diopters can be used if the adjustable viewfinder diopter is not sufficient.

These accessories are mounted on the viewfinder frame as described above. For more information on these and other accessories, contact your Konica Minolta dealer.

# EXPOSURE COMPENSATION

Camera exposure can be changed by as much as  $\pm 3.0$  Ev to make the final image lighter or darker. For information on Ev, see page 31. Exposure compensation cannot be used in the manual-exposure mode.

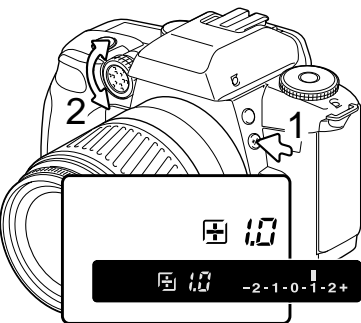

Press and hold the exposure-compensation button (1) and turn the control dial (2) to select the degree of compensation. This value is displayed in the aperture display and on the Ev scale. For more on the Ev scale, see page 39.



Once set, the exposure-compensation indicator shows an increase (+) or decrease (-) to the metered exposure. The viewfinder Ev scale displays the degree of compensation.

In the program, aperture-priority, and shutter-priority modes, the degree of compensation set in one mode is applied to the other two; exposure compensation is not reset when the camera is turned off, but is reset if the mode dial is turned to the full-auto program or subject program position. With full-auto program and subject programs, exposure compensation is reset when the position of the mode dial is changed.

Exposure compensation can be used when the camera's exposure meter is deceived by certain conditions. For example, a very bright scene, such as a snowy landscape or a white sandy beach, can appear too dark in the final image. Before taking the picture, adjusting the exposure by +1 or +2 EV will result in an image with normal tonal values.



Metered exposure

-1.0Ev

-2.0Ev

In the example above, the dark water caused the camera to overexpose the image making it bright and washed-out. By compensating the exposure, detail is brought out in the leaves, and the stones and water appear richer.

## DEPTH OF FIELD PREVIEW

To provide the brightest viewfinder image possible, the camera only closes the lens aperture during the exposure. The aperture can be stopped down to preview its affect on depth of field (p. 30).

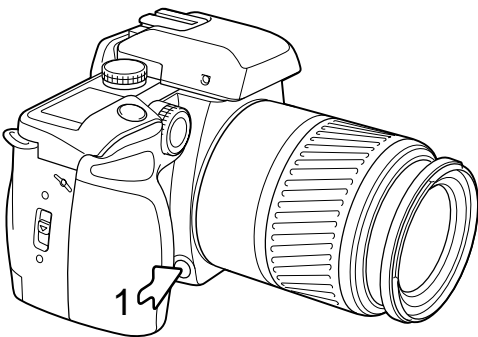

Focus the camera. While looking through the viewfinder, press and hold the depth-of-field preview button (1) to stop the lens down to the aperture in use.

## AE LOCK BUTTON

The AE-lock button locks the exposure without activating the AF system. This allows the exposure to be set with a gray card or a reference target outside the scene. The operation of the AE-lock button can be changed with custom function 9 (p. 70). This button is disabled in shutter-priority and manual-exposure modes.

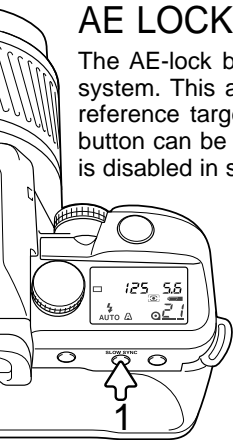

Frame the exposure target in the viewfinder depending on the metering mode in use (p. 58). Press the AEL button (1) to lock the exposure; the shutter speed and aperture are displayed and the AEL indicator is displayed in the viewfinder. Release the button to cancel the lock.



While holding the AEL button, place the subject in the focus frame and press the shutter-release button partway down to focus (2). Press the shutter-release button down all the way to take the picture.

The exposure remains locked after the picture is taken if the AEL button is not released.

While the exposure is locked, the camera meter is still active. The viewfinder Ev scale shows the difference between the locked exposure and the current light level measured with the meter.



AEL indicator

Ev scale

When the Ev scale indicates 0, the locked exposure shown in the shutter-speed and aperture displays is the same as the exposure determined by the meter.



The metered exposure is one stop less (-) than the locked exposure.



The arrow indicates the metered exposure is two and a half stops more (+) or less (-) than the locked exposure.



The blinking arrow indicates the metered exposure is three or more stops greater (+) or less (-) than the locked exposure.

## ABOUT SLOW SYNC.

When using flash, pressing the AEL button activates the slow-sync. function. This gives the same effect as the night portrait subject program (p. 27) which balances the ambient light exposure with the flash exposure so the background is recorded with the subject.

When the AEL button is pressed and held, the ambient light exposure is determined and the flash exposure is based on the locked aperture setting. The affect of slow sync. is only apparent in low-light conditions. The use of a tripod is recommended with slow-sync. exposures.

## AF BUTTON

The AF button allows the camera to be focused on a specific target using the spot focus area or one of the eight local-focus areas.

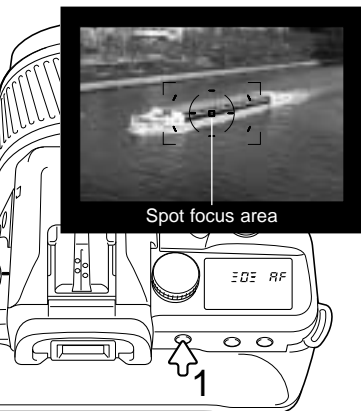

Place the spot focus area on the subject.

Press and hold the AF button (1) to focus. The focus remains locked until the button is released. When the button is released, the wide focus frame is active.

While continuing to hold the AF button, press the shutter-release partway down to lock the exposure, and then all the way down to take the picture.

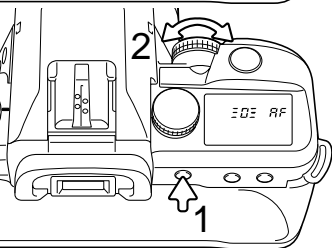

To use one of the eight-local focus areas, press and hold the AF button (1) and turn the control dial (2) to select the area; the shutter speed display indicates the active area.

The appropriate area should be placed on the subject as the camera focuses as each area is selected.

While continuing to hold the AF button, press the shutter-release partway down to lock the exposure, and then all the way down to take the picture.

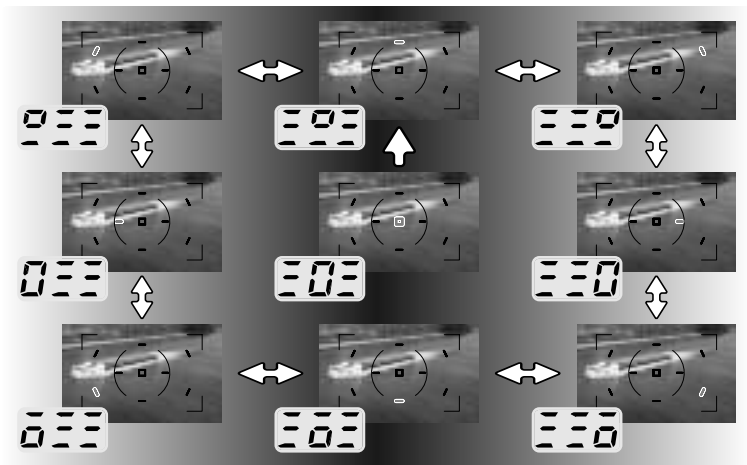

The shutter speed display on the data panel and in the viewfinder indicates the active focus area. The area is briefly illuminated in the viewfinder when it is selected.

When the AF button is initially pressed, the spot focus area is active. The control dial is used to cycle through the local-focus areas. To select the spot focus area after selecting a local area, release and then press the AF button again.

## Camera Notes

Custom function 8 changes the operation of the AF button. See page 69 for information.

## MANUAL FOCUS - MF

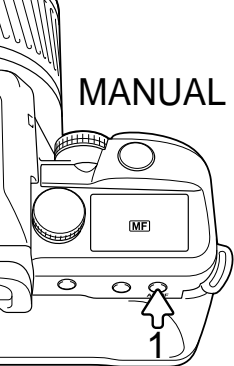

The lens can be manually focused. Simply press the focus-mode button (1) to switch between autofocus and manual focus. When manual focus is active, the manual-focus indicator is displayed on the data panel and in the viewfinder.

Turn the focusing ring on the lens until the viewfinder image is sharp.

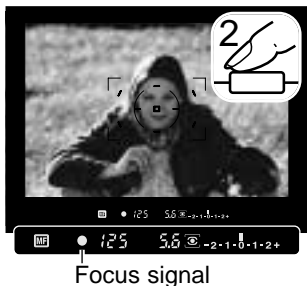

The AF system can assist focusing. Place the subject in the focus frame. While pressing the shutter-release button partway down (2), turn the focusing ring until the focus signal appears.

Focus signal

When using non D series lenses, the camera switches to center-weighted metering. The metered exposure may be different in autofocus and manual focus.

In the program, aperture-priority, shutter-priority, manual-exposure modes, when manual focus is activated in one mode it is active in the other three; manual focus is not reset to autofocus when the camera is turned off, but is reset if the mode dial is turned to the full-auto program or subject program position. With full-auto program and subject programs, manual focus is reset to autofocus when the position of the mode dial is changed.



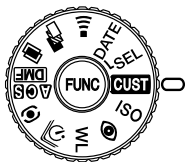

## FUNCTION DIAL

The function dial controls many of the camera's creative functions and camera operations. For descriptions of the functions, refer to the appropriate sections.

**CUST**

Custom functions (p. 64)

**ISO**

Custom ISO (p. 57)



Red-eye reduction (p. 59)

**WL**

Wireless / Remote flash (p. 60)



Drive modes (p. 50)



Metering modes (p. 58)



AF modes (p. 56)



Multiple exposure (p. 53)



Exposure bracketing (p. 54)



Audio signals (p. 49)

**DATE**

Date imprinting (p. 63) (Date model only)

**SEL**

Date and time setup (p. 18) (Date model only)

## AUDIO SIGNALS

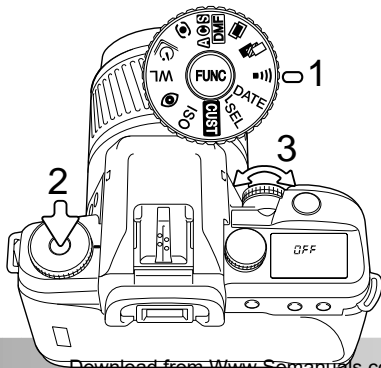

The audio signal gives a positive confirmation for focus lock and when using the self-timer and remote control. The signal can be turned off.

Turn the function dial to the audio-signal position (1). While pressing the function button (2), turn the control dial until "On" or "OFF" is displayed on the data panel.

## DRIVE MODES

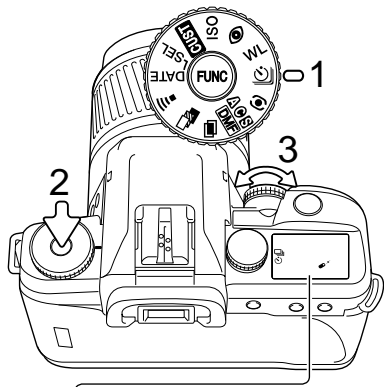

The drive modes control how pictures are captured. Four drive modes are available.

Turn the function dial to the drive-mode position (1).

While pressing the function button (2), turn the control dial (3) until the appropriate drive mode is displayed on the data panel. Release the function button to complete the operation.



**Single-frame advance** - to take a single image each time the shutter-release button is pressed (p. 21).



**Continuous advance** - to take a series of images when the shutter-release button is pressed and held (p. 51).



**Self-timer** - to delay the release of the shutter by approximately ten seconds. Used for self portraits (p. 51).



**Remote control** - to release the shutter from up to 5m (16.4ft.) away with the optional Remote Control RC-3 (p. 52).

## CONTINUOUS-ADVANCE NOTES

The maximum frame rate with continuous advance is 3 frames per second with a shutter speed of 1/250 or faster, no flash, single-shot AF or manual focus, fresh batteries and no date imprinting. AF Zoom xi and Power Zoom lenses cannot be zoomed when taking pictures with continuous advance.

The frame rate is affected by the shutter speed, flash, and AF mode. The built-in flash must recharge between exposures. When using an accessory flash, the camera continues to take pictures regardless if the flash has charged. The frame rate may be reduced when using continuous AF or with moving subjects with Automatic AF as the camera focuses between exposures.

## SELF-TIMER NOTES

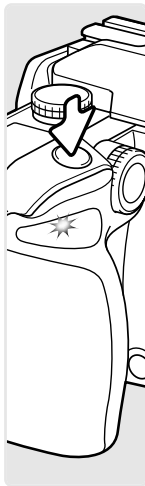

When the shutter-release button is pressed partway down, focus and exposure is locked for the picture. Do not stand directly in front of the camera when pressing the shutter-release button. To change the focus point, release the shutter button and then press it partway down again.

Press the shutter-release button all the way down to start the timer. The self-timer lamp on the front of the camera blinks, then glows steadily just before the shutter releases. The audio signal accompanies the self-timer lamp.

To cancel the self-timer countdown, change the position of the mode dial. The self-timer drive mode is canceled after the picture is taken. Attach the eyepiece cap if a bright light source is behind the camera (p. 41).

## REMOTE CONTROL NOTES

The camera can be operated up to 5m (16.4 ft.) away with the IR Remote Control RC-3 (sold separately). For detailed operation, refer to the RC-3 instruction manual. The remote-control drive mode is set with the function dial (p. 50).

Point the remote control toward the camera and press the release or the delay button. If the built-in flash pops up when the release button is pressed, wait a few seconds for the flash to charge and then press the release button again.

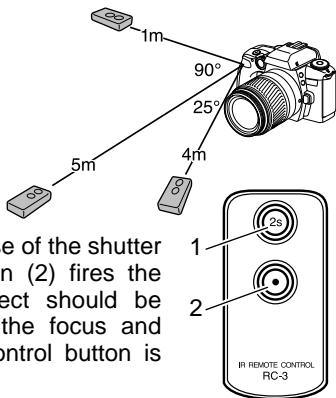

The delay button (1) delays the release of the shutter for two seconds. The release button (2) fires the shutter without a delay. The subject should be positioned within the focus frame; the focus and exposure are set when a remote-control button is pressed.

Focus lock can be used. To refocus the camera, press the shutter-release button partway. Changing the position of the mode dial cancels the focus and exposure lock.

When making bulb exposures (p. 40), the pressing the remote-control buttons once starts the exposure; pressing the button a second time ends it. The delay button delays the start of the exposure by two seconds. The remote control can also be used with multiple exposures (p. 53) and bracketing (p. 54).

To save power, the drive mode is canceled if an operation is not made within five minutes. Attach the eyepiece cap if a bright light source is behind the camera (p. 41).

## MULTIPLE EXPOSURES

The multiple-exposure function makes it possible to expose two or more images on the same frame. The built-in flash can be used, but overexposure could result.

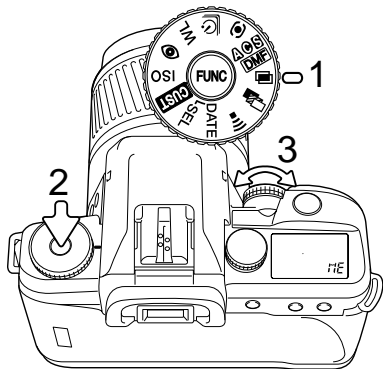

Turn the function dial to the multiple-exposure position (1).

While pressing the function button (2), turn the control dial (3) until "ME" is displayed in the frame counter. Release the function button. The first exposure can be taken.

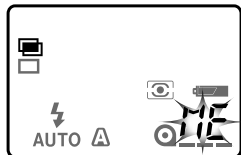

ME will blink on the data panel after the initial exposure to indicate the next exposure will be the final one. Press the shutter-release button to take the second exposure and advance the film. Multiple-exposure mode is canceled after the last exposure.

To make more than two exposures, press the function button and turn the control dial to stop "ME" blinking after the initial exposure. An unlimited number of exposures can be made by repeating this procedure.

The camera meter indicates the required exposure for a single picture. Depending on the scene, the exposure may have to be compensated.

# EXPOSURE BRACKETING

This function makes a three-image bracket of a scene. Bracketing is a method of taking a series of images of a static subject in which each image has a slight variation in exposure. Bracket your exposures when shooting slides and other films with a small exposure latitude.

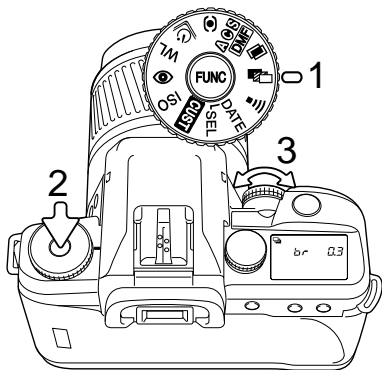

Turn the function dial to the exposure-bracketing position (1).

While pressing the function button (2), turn the control dial (3) to select the bracketing step: 0.3Ev, 0.5Ev, 0.7Ev, or 1.0Ev. The larger the number, the greater the difference between exposures. For more on Ev, see page 31. Release the function button.

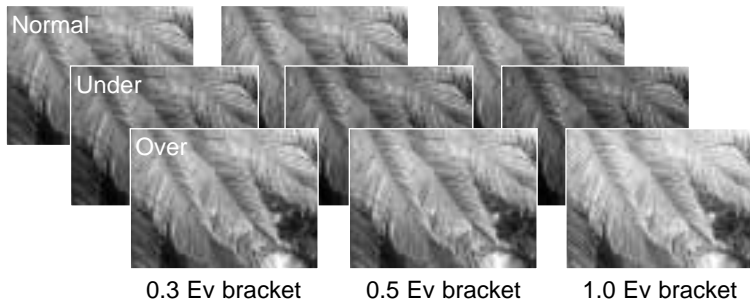

The order of the bracketing series is normal exposure, underexposure, and overexposure. The built-in or accessory flash cannot be used with bracketing; the flash is automatically canceled.

When the bracketing function is initially selected, the drive mode is automatically set to continuous advance. Compose the picture as described in the taking-a-picture section (p. 21). The focus and exposure are locked with the first frame.

Press and hold the shutter-release button all the way down to make the bracketing series; three consecutive frames are taken. If the shutter button is released before the last frame of the series is taken, the bracket series is reset.

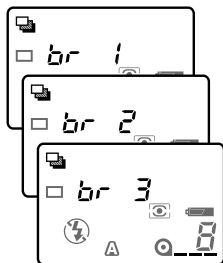

Changing the drive mode (p. 50) to single-frame advance, self-timer, or remote control allows each frame to be taken each time the shutter-release button is pressed all the way down; the self-timer drive mode is reset after each exposure. The data panel indicates the next bracketing frame in the series.

To cancel the current bracketing series, turn the camera off. To cancel the bracketing function, press the function button and turn the control dial until "OFF" is displayed on the data panel.

## Camera Notes

A button shortcut allows exposure bracketing to be used with specific subjects. Press and hold the exposure-compensation button while pressing and holding the shutter-release button for the duration of the automatic three-frame 0.5 Ev bracket.

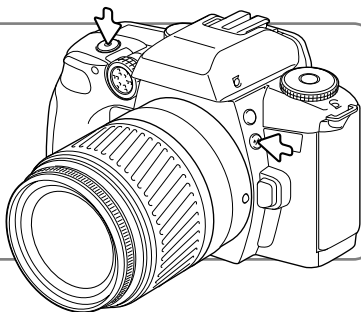

## AF MODES

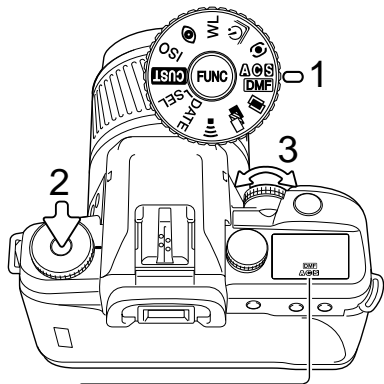

This function controls how the AF system works. Four modes are available.

Turn the function dial to the AF-mode position (1).

While pressing the function button (2), turn the control dial (3) until the appropriate AF mode is displayed on the data panel. Release the function button to complete the operation.

**A**

**Automatic AF** - the camera automatically switches between single-shot AF and continuous AF.

**C**

**Continuous AF** - for moving subjects. The camera continually focuses.

**S**

**Single-shot AF** - for static subjects. focus lock (p. 23) can be used.

**DMF**

**Direct Manual Focus** - when focus is locked, the lens can be manually focused. Available with D series lenses only.

The viewfinder focus signal indicates AF status.



Focus locked.



Focus is confirmed (Continuous AF).



Indicator blinks - cannot focus. The shutter is locked.



Focusing (Continuous AF). The shutter is locked.



In continuous AF, the camera will continue to adjust focus when the shutter-release button is pressed partway down. Focus lock cannot be used.

With Direct Manual Focus (DMF), press the shutter-release button partway down to lock focus. When the manual focus indicator (MF) appears, the lens can be refocused manually. Available with D series lenses only. When using SSM series lenses, the DMF function incorporated in the lens should be used.

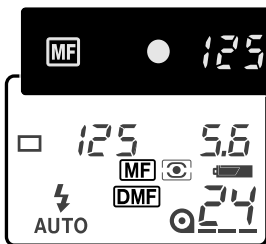

## MANUAL ISO

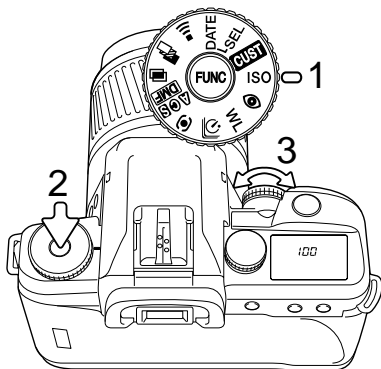

The film speed can be set manually from ISO 6 to ISO 6400 in 1/3 Ev steps.

Turn the function dial to the ISO position (1).

While pressing the function button (2), turn the control dial (3) until the appropriate ISO is displayed on the data panel. Release the function button to complete the operation.

The film speed can be set for DX-coded and non-DX-coded film. A custom ISO setting can be applied to film with the same DX code with custom function 4 (p. 67). The film speed of a loaded roll of film can be confirmed through the film window in the back cover of the camera.

# METERING MODES

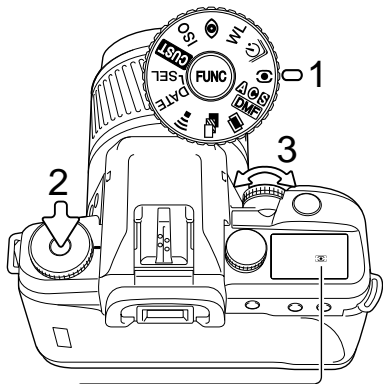

The metering modes control how light is measured. The metered exposure may vary between autofocus and manual focus.

Turn the function dial to the metering-mode position (1).

While pressing the function button (2), turn the control dial (3) until the appropriate metering mode is displayed on the data panel. Release the function button.



**14-segment honeycomb-pattern metering** - the camera's standard metering mode appropriate for most photographic situations. By combining information from the autofocus system, this mode is less influenced by spot lighting or backlighting. When using non-D series lenses with manual focus, this mode changes to center-weighted metering.



**Center-weighted metering** - light values of the entire scene are measured with emphasis given to the central area.



**Spot metering** - the area in the spot circle in the viewfinder is used to determine the exposure. The spot allows a specific object to be measured without being influenced by bright or dark areas within the scene.

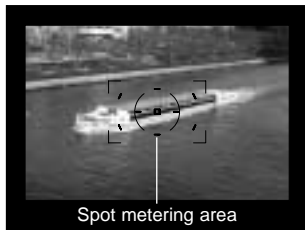

## RED-EYE REDUCTION

Red-eye reduction is used when taking photographs of people or animals in low-light conditions. The red-eye effect is caused by light reflected from the retina of the eye. The camera fires several pre-flashes before the main flash burst to contract the pupils of the subject's eyes.

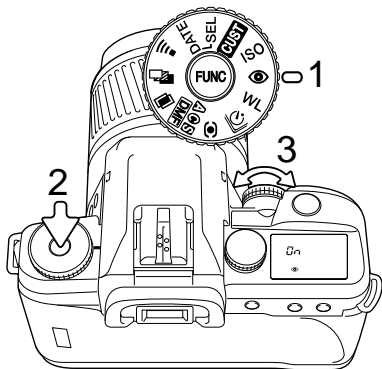

Turn the function dial to the red-eye reduction position (1).

While pressing the function button (2), turn the control dial (3) until "On" is displayed on the data panel. Release the function button.

When this function is active, the red-eye reduction indicator is displayed on the data panel. To cancel red-eye reduction, repeat the procedure above until "OFF" is displayed in the data panel.

Red-eye reduction can be used with autoflash and fill flash (p. 24). It cannot be used with accessory flash units nor wireless/remote flash control.

## WIRELESS / REMOTE FLASH

Wireless/Remote flash allows the camera to control an off-camera 5600HS (D), 3600HS (D), 5400HS, 5400xi, or 3500xi flash unit without the need of a cable. Single or multiple flash units can be placed around the subject to create special lighting effects.



On-camera  
flash



Wireless/  
Remote  
flash

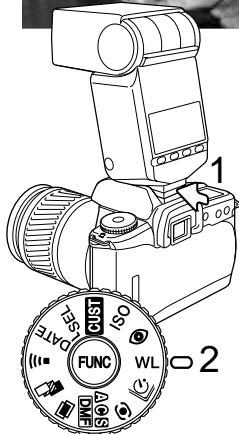

The camera's built-in flash fires to control the off-camera flash units rather than to illuminate the subject. See your local camera dealer about Minolta lighting accessories.

Slide the Minolta 5600HS(D) or 3600HS(D) flash on the accessory shoe until the safety lock engages (1).

Turn on the camera and flash unit.

Turn the function dial to the wireless / remote position (2).

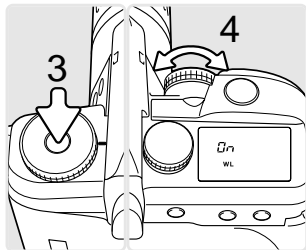

While pressing the function button (3), turn the control dial (4) until "On" is displayed on the data panel. Release the function button. This simultaneously sets the camera and flash to the wireless mode.

Remove the flash from the camera.

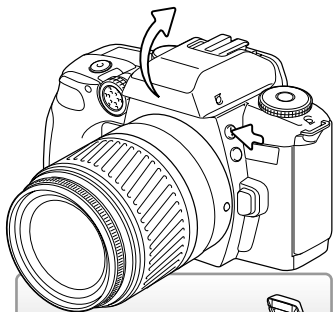

Press the flash mode button to raise the flash.

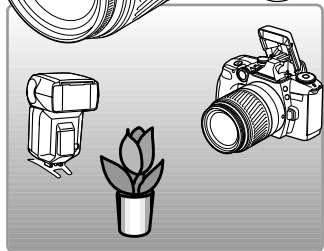

Position the camera and flash around the subject. See the following page for the camera-to-subject and flash-to-subject ranges. Make sure no objects come between the camera and flash unit.

The flash units can be test fired by pressing the AEL button on the camera; custom function 9 must be set to 1 (p. 64). If the flash does not fire, change the camera, flash, or subject position.

When the 5600HS(D) and 3600HS(D) flash is charged, the AF illuminator on the front of the unit blinks. Take a picture as described in the basic operation section on page 21.

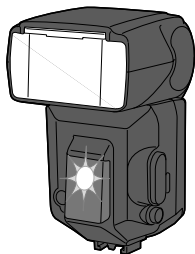

To cancel wireless/remote flash, mount the flash on the camera and turn the function off using the function button and control dial. For more about flash operation, refer to the manual supplied with the flash unit.

## WIRELESS / REMOTE FLASH NOTES

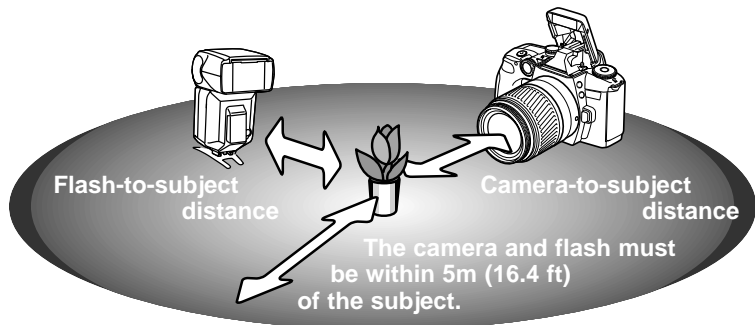

The following chart lists the minimum distances required when using Program/Maxxum Flash 5600HS (D) and 3600HS (D). For more detailed information or when using High Speed Sync. (HSS), refer to the flash unit manual.

Aperture	Min. camera-to-subj. dist.		Min. flash-to-subj. dist.	
	ISO 100	ISO 400	ISO 100	ISO 400
<i>f</i> /2.8	1.4m / 4.6ft	2.8m / 9.2ft	1.4m / 4.6ft	2.8m / 9.2ft
<i>f</i> /4.0	1.0m / 3.3ft	2.0m / 6.6ft	1.0m* / 3.3ft*	2.0m / 6.6ft
<i>f</i> /5.6	1.0m / 3.3ft	2.0m / 6.6ft	1.0m* / 3.3ft*	2.0m / 6.6ft

\* The maximum flash-to-subject distance when using Program/Maxxum Flash 3600HS (D) is 3.5m (11.5ft) at *f*/4.0 and 2.5m (8.2ft) at *f*/5.6 with ISO 100 film.

Wireless/Remote flash performs best under subdued light or interior lighting. Under bright light sources, the flash may not be able to detect the control signals from the camera's built-in flash.

When not using off-camera flash units, always turn off the wireless flash mode; inaccurate flash exposures will result.

## DATE IMPRINTING - DATE MODEL

The date or the day and time the picture is taken can be imprinted in the bottom right corner of a horizontal image. See page 18 to set camera's clock and calendar.

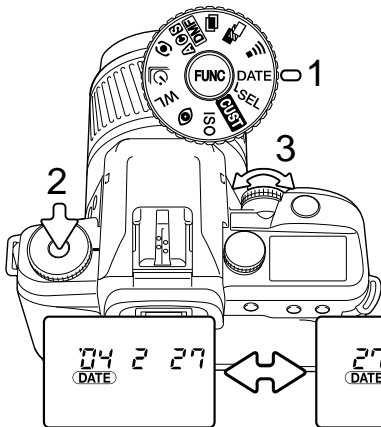

Turn the function dial (1) to the date position.

While pressing the function button (2), turn the control dial (3) to select date imprinting, time imprinting, or imprinting off. The date indicator remains on the data panel to show imprinting is active.

Date imprinting

Time imprinting

Imprinting off

The date format is changed with custom function 15 (p. 64). Three formats are available: year / month / day, month / day / year, and day / month / year.

Imprinted data may be difficult to read if the lower-left corner of the photograph is bright or non-uniform. Do not use the data back when temperatures are outside the range of 0° to 50°C (32° to 122°F). Since the date is recorded when the film is advanced to the next frame, sometimes the last frame of the roll will not have the date imprinted on it.

# CUSTOM FUNCTIONS

Custom functions allow camera operations to be changed.

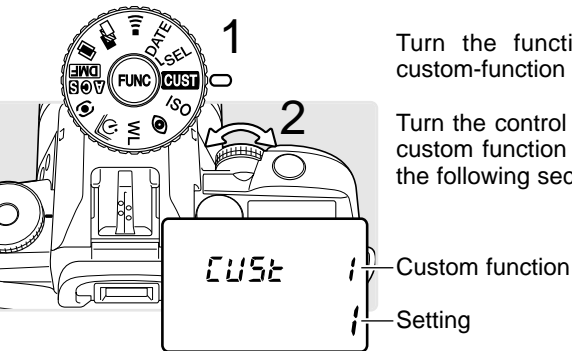

Turn the function dial (1) to the custom-function position (CUST).

Turn the control dial (2) to select the custom function to be changed. See the following sections for details.

Press and hold the function button (3) and turn the control dial (4) to change the custom-function setting displayed in the frame counter.

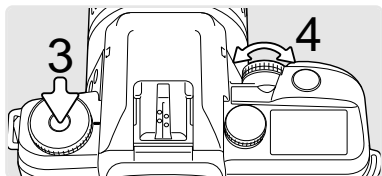

## Camera Notes

When the function dial is in the custom-function position, the shutter-release button is still active and pictures can be taken. The other camera buttons are disabled. With the date model, the shutter-release button is also active in the date-selection position.

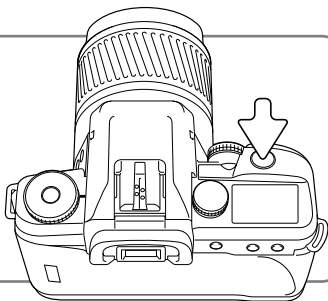



Custom function	Setting
1 AF/shutter priority	1 AF priority
	2 Release priority
2 Film rewind	1 Automatic
	2 Manual
3 Film leader at rewind	1 Wind in
	2 Leave out
4 DX memory	1 Off
	2 On
5 Shutter lock - no film	1 Unlocked
	2 Locked
6 Lens focus-hold button	1 Focus hold
	2 Continuous AF
	3 Depth-of-field preview
7 Program shift	1 Off
	2 PA (Aperture shift)
	3 Ps (Shutter-speed shift)
8 AF button	1 Spot focus priority
	2 AF-area selection
	3 Wide / spot focus area toggle
9 AEL button	1 Hold
	2 Toggle
10 AF illuminator	1 On
	2 Off
11 Flash metering	1 ADI
	2 TTL
12 Focus area illumination	1 0.3 sec. focus lock indication
	2 0.6 sec. focus lock indication
	3 Focus area selection only
13 Shutter lock - no lens	1 Locked
	2 Unlocked
14 Shutter lock - back open	1 Locked
	2 Unlocked
15 Date format (Date model)	1 Year / month / day
	2 Month / day / year
	3 Day / month / year

## CUSTOM 1 - AF/SHUTTER PRIORITY

Custom function 1 has two settings:

- 1 AF priority. Shutter will not release until the camera focuses.
- 2 Shutter-release priority. Shutter releases even if the focus cannot be confirmed. Use shutter-release priority when photographing moving subjects. When using the continuous-advance drive mode, the camera does not focus between exposures.

## CUSTOM 2 - FILM REWIND

Custom function 2 has two settings:

- 1 Automatic. The film is automatically rewound at the end of the roll.
- 2 Manual. The manual-rewind button must be pressed at the end of the roll to initiate rewind (p. 29).

## CUSTOM 3 - FILM LEADER

Custom function 3 has two settings:

- 1 Wind in. The film is completely rewound into the cartridge.
- 2 Leave out. The film leader is exposed after rewind. Turning the camera off during rewinding allows the film leader to be rewound into the cartridge by turning the camera on after the film transport motor has stopped.

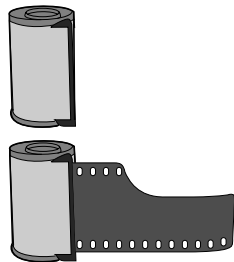

## CUSTOM 4 - DX MEMORY

Custom function 4 has two settings:

- 1 DX Memory Off. The film speed is set automatically to the ISO of DX-coded film. Non-DX-coded film is set to the ISO of the previous DX-coded roll.
- 2 DX Memory On. A change to the ISO setting of a DX-coded film is saved and applied to other DX-coded rolls with the same film speed. This is used when a particular film is consistently push or pull processed. To set film speed manually, see page 58.

## CUSTOM 5 - SHUTTER LOCK (FILM)

Custom function 5 has two settings:

- 1 Unlocked. Shutter can be released even if no film is in the camera.
- 2 Locked. Shutter cannot be released with no film in the camera; 0 blinks in the viewfinder and on the data panel as a warning when the shutter-release button is pressed.

## CUSTOM 6 - FOCUS-HOLD BUTTON

For lenses equipped with a focus-hold button. The operation of the focus hold-button can be customized:

- 1 Focus Hold. Pressing the focus-hold button on the lens locks the autofocus.
- 2 Continuous AF. Pressing and holding the focus-hold button activates continuous AF. See page 56 for more information on AF modes.
- 3 Depth-of-field preview. Pressing the focus-hold button stops down the lens to the set aperture to view the affect of depth of field on the image (p. 43).

## CUSTOM 7 - PROGRAM SHIFT

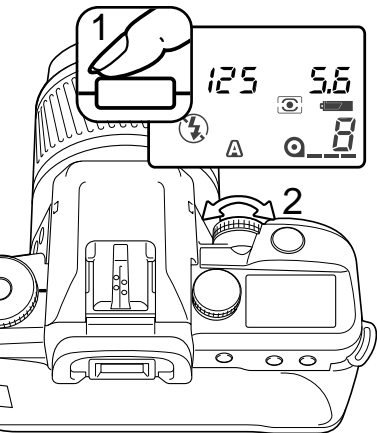

Program shift allows the aperture and shutter speeds set in full-auto program and program exposure modes to be changed without affecting the total exposure. When program shift is active, the autoflash mode is disabled (p. 24).

Press the shutter-release button partway down (1) to activate the exposure system.

When the exposure is displayed, turn the control dial (2) to change the aperture and shutter speed combination.

Custom function 7 has three settings:

- 1 Off. Autoflash is available.
- 2 PA. The aperture can be shifted and the shutter speed automatically compensates to provide the correct exposure.
- 3 Ps. The shutter speed can be shifted and the aperture automatically compensates to provide the correct exposure.

Fill flash can be used when program shift is selected, however the exposure cannot be shifted. Program shift is canceled when the flash is raised.

# CUSTOM 8 - AF BUTTON

The operation of the AF button can be customized:

- 1 Spot focus priority. When the AF button is pressed and held, the spot focus area is active. The local focus areas can be selected with the control dial. When the AF button is released, the wide focus area is active. See page 46.
- 2 Focus area selection. The focus area can be selected between the wide focus area, the spot focus area, or one of the eight local-focus areas. Press the AF button and turn the control dial to select the area. The area remains active when the AF button is released. The area must be reset manually, or by turning the mode dial to the full-auto program or subject program positions.
- 3 Wide / spot focus area toggle. Pressing the AF button switches between the wide focus area and spot focus area.

The shutter-speed display on the data panel and in the viewfinder indicates the active focus area when the AF button is pressed.

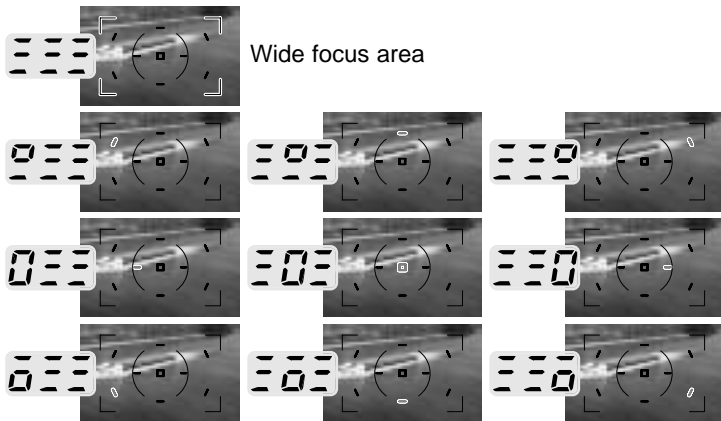

## CUSTOM 9 - AEL BUTTON

This custom function changes the operation of the AE lock button. Custom function 9 has two settings:

- 1 Hold. Press and hold the AEL button to lock the exposure, see page 44.
- 2 Toggle. Press the AEL button once to lock the exposure. Press it a second time to cancel the lock. The lock will remain in effect until canceled even after the exposure.

## CUSTOM 10 - AF ILLUMINATOR

The built-in flash is used as an AF Illuminator. When the scene is too dark for the camera to focus, the built-in flash fires a few short bursts when the shutter-release button is pressed partway down to provide the light necessary for the camera to focus.

Pressing the AF button also activates the AF illuminator. The range of the AF Illuminator is approximately 1 to 5 m ( 3.3 to 16.4 ft.). When an accessory flash is attached, the flash unit is used as the AF illuminator in place of the camera's built-in flash.

The AF illuminator will not fire in continuous AF mode or with flash cancel. The AF illuminator may not operate with focal lengths of 300mm or longer or with 3x-1x Macro Zoom.

Custom function 10 has two settings:

- 1 AF Illuminator On.
- 2 AF Illuminator Off. An attached accessory flash's AF illuminator is not canceled.

# CUSTOM 11 - FLASH METERING

The metering mode for both the built-in and accessory flash can be specified:

- 1 ADI Flash Metering. When the flash fires, ADI or pre-flash TTL metering will be employed. Flash metering changes according to the flash unit and lens being used, see below.

ADI (Advanced Distance Integration) metering uses the distance information from D series lenses in addition to TTL metering during the exposure. With the 5600HS (D), 3600HS (D), and 2500 (D) accessory flash units, a pre-flash is also used. With ADI metering, the exposure system is less influenced by background conditions or the subject's reflectance. Pre-flash TTL uses a pre-flash to determine the reflectance of the scene as well as controlling the flash output during the exposure.

- 2 TTL (Through The Lens) Flash Metering. The TTL flash metering system controls the flash during the exposure automatically. No pre-flash is used. To use flash or color meters, or neutral density filters, the flash mode must be set to TTL metering.

Flash	D series lens	Other lenses
Camera flash	ADI	TTL
Program/Maxxum 5600HS (D)* 3600HS (D)* 2500 (D)	ADI (with pre-flash)	Pre-flash TTL
Program/Maxxum 5400HS*	Pre-flash TTL	Pre-flash TTL
Other flash units	TTL	TTL

\* HSS (High Speed Sync.) must be active. If off, TTL metering is used.

## CUSTOM 12 - FOCUS AREA ILLUMINATION

During focus lock, the spot focus area or one of the local focus areas are illuminated to indicate the focus point. The areas are also illuminate when selected using the AF button (p. 46). Custom function 12 has three settings:

- 1 0.3 second focus lock indication. The active AF area used for focus is illuminated for 0.3 seconds.
- 2 0.6 second focus lock indication. The active AF area used for focus is illuminated for 0.6 seconds.
- 3 Focus area selection only. The focus areas are only illuminated when selected using the AF button.

## CUSTOM 13 - SHUTTER LOCK (LENS)

Custom function 13 has two settings:

- 1 Locked. Shutter can only be released when a lens is mounted on the camera.
- 2 Unlocked. Shutter can be released when no lens is mounted on the camera. Use this setting when attaching the camera to a telescope or microscope.

## CUSTOM 14 - SHUTTER LOCK (BACK)

Custom function 14 has two settings:

- 1 Locked. Shutter can only be released when the back of the camera is closed.
- 2 Unlocked. Shutter can be released when the back of the camera is open.



## CUSTOM 15 - DATE FORMAT (DATE MODEL)

The format of the imprinted date can be changed. Custom function 15 has three settings:

1 Year / Month / Day

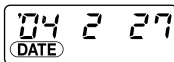

2 Month / Day / Year

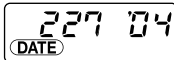

3 Day / Month / Year

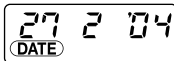

## CUSTOM FUNCTION RESET

All of the custom functions can be reset to their initial setting, 1. Custom 15 in the date model is not reset.

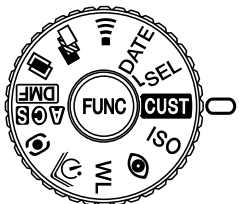

With the camera off, turn the function dial to the custom function position (CUST).

While pressing the function button (1), turn the camera on; clear (CLr) blinks on the data panel to confirm the operation. Release the function button.

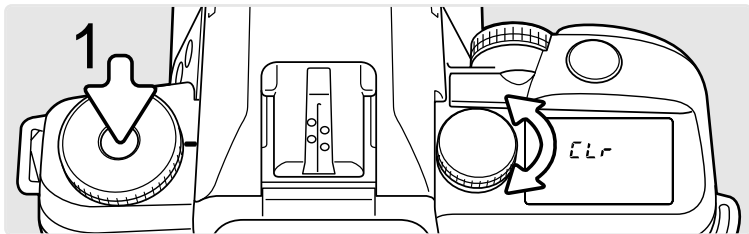

# ACCESSORY NOTES

This product is designed to work with accessories manufactured and distributed by Konica Minolta. Using accessories or equipment not endorsed by Konica Minolta may result in unsatisfactory performance or damage to the product and its accessories.

## LENS NOTES

Only Minolta A-mount lenses can be used with this camera. For the current line of our lenses, contact your Konica Minolta dealer.

This camera is sold by itself or with the following lens:

AF 28-100mm f/3.5-5.6 (D)	
Construction	10 elements in 8 groups
Angle of view	75° - 24°
Minimum focus distance	0.48m / 1.6ft
Maximum magnification	0.25X
Minimum aperture	f/22-38
Filter diameter	55mm
Dimensions	66mm (dia.) X 78mm (L) 2.6in. (dia.) X 3.1in. (L)
Weight	240g / 8.5oz.

Specifications are based on the latest information available at the time of printing and are subject to change without notice.

When the lens is not in use, always attach the lens cap to protect front element. Press the tabs on the lens cap to remove or attach.

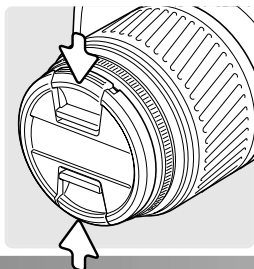

A lens hood improves image quality by reducing flare, non-image forming light.

Slide the lens hood onto the bayonet mount at the end of the lens. Turn the hood clockwise until it clicks into place.

The hood can be reverse mounted for storage. The lens cap can be attached with the hood mounted.

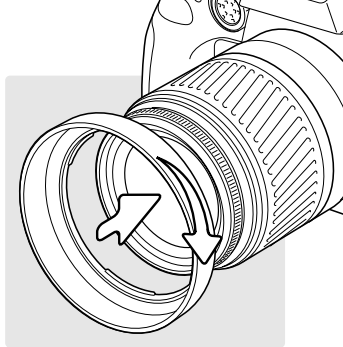

Lens shadowing occurs when the lens or lens hood blocks part of the output from the built-in flash. Lens shadowing appears as a semi-circular shadow at the bottom (horizontal pictures) or side (vertical pictures) of the image. Remove the lens hood before using the built-in flash.

Lens shadowing may occur with the following lenses at the shorter focal lengths:

- AF Zoom 28-70mm f/2.8G
- AF Zoom 17-35mm f/3.5G
- AF Zoom 28-135mm f/4.0-4.5
- AF Zoom 28-85mm f/3.5-4.5

The built-in flash can not be used with the following lenses:

- AF 300mm f/2.8 Apo G(HS)
- AF 600mm f/4.0 Apo G(HS)
- AF 300mm f/2.8 Apo G(D)SSM

When using a filter with a filter factor greater than 0, or the focus-range limiter or macro release on certain lenses, the proper exposure cannot be obtained with ADI or Pre-flash metering. Set custom function 11 to setting 2 and set the accessory flash to a flash mode that does not use a pre-flash.

## ACCESSORY FLASH NOTES

When using an accessory flash, the viewfinder flash signals are the same for the built-in flash (p. 25). The following flash units are compatible with this camera:

Program/Maxxum Flash 5600HS (D)

Program/Maxxum Flash 3600HS (D)

Program/Maxxum Flash 2500 (D)

Macro Twin Flash 2400

Macro Ring Flash 1200

Contact your Konica Minolta dealer for information on these products.

All Minolta i, si, and HS series flash units, and the Vectis SF-1 flash are compatible with this camera. The Flash Shoe Adapter FS-1100 is required to mount AF series flash units (4000AF, 2800AF, 1800AF, and Macro flash 1200AF). When the FS-1100 is used, the flash mode is set to fill flash and the AF illuminator is canceled. X-series flash units and flash units sold by other manufacturers cannot be used with this camera.

The flash mode of an accessory flash can be set with the camera.

Press and hold the flash-mode button (1) and turn the control dial (2) to select the flash mode. Release the button to complete the operation. The flash mode is displayed on the data panel.

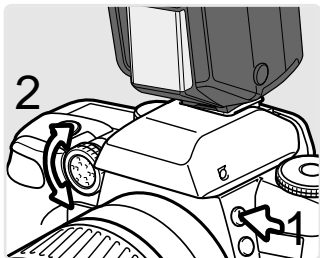

The following flash accessories can be used with this camera:

Off-camera Shoe OS-1100

Off-camera Cable OC-1100

PC Terminal Adapter

## HIGH SPEED SYNC. (HSS)

This camera is compatible with the High Speed Sync. (HSS) function in the Program/Maxxum Flash 5600HS (D), 5400HS, and 3600HS (D). This allows the camera to use its full range of shutter speeds up to 1/2000 second.

Attach a compatible flash unit to the camera. Set the flash unit to HSS. When the shutter speed exceeds 1/90 second, the High Speed Sync. indicator (H) is displayed on the data panel and in the viewfinder.

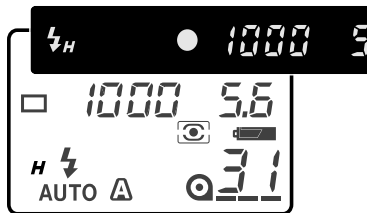

## WIRELESS CONTROLLER IR-1N

The camera can be permanently damaged if used with the Wireless Controller IR-1N.

The information in this manual is relevant for products available at the time of printing. Contact the nearest authorized Minolta Service facility to obtain compatibility information for products released after this date.

# TROUBLESHOOTING

Contact your nearest Konica Minolta Service Facility if the following information does not cover the problem or the condition continues.

Problem	Cause	Solution
Autofocus does not work when the shutter-release button is pressed partway down.	A special focusing situation is preventing the AF system from focusing (p. 22).	Use focus lock (p. 23) or manual focus (p. 48).
	Camera is set to manual focus.	Press the AF/MF button.
	Subject is too close.	Check the lens' minimum focus distance.
Shutter cannot be released.	Focus cannot be confirmed.	Use focus lock (p. 23) or manual focus (p. 48).
	Camera is attached to a microscope or telescope.	Set custom 13 to setting 2.
Flash fires when the shutter-release button is pressed partway down.	Flash was used as AF illuminator to assist the autofocus system.	To turn off the AF illuminator, set the flash mode to flash cancel or custom 10 to setting 2.
Picture is blurred.	Flash did not fire in a low-light situation and the shutter speed was slow.	Use fill flash, a tripod, or faster film.

Flash picture is too dark.	Subject is beyond flash range.	Make sure the subject is within the flash range.
When using the built-in flash, the bottom of the picture is dark.	Lens hood was attached or subject distance was less than 1m (3.3ft).	Remove the lens hood. To prevent lens shadowing, the subject must be at least 1m (3.3ft.) from the camera.
Err appears on the data panel.	Remove the batteries. Reinsert them after turning the camera off and on. If normal camera operation does not resume or the camera malfunctions repeatedly, contact an authorized Konica Minolta service facility.	

**CAUTION:** if the film was not rewound, opening the back cover with this method will fog the film; use a film changing bag, completely dark room, or place the camera under a thick blanket.

To remove the film from the camera in case of a malfunction, use the following procedure:

1. Turn the camera off.
2. Turn the function dial to the ISO position.
3. While pressing the function button and AEL button, turn the camera on. The film transport motor will activate for a second to release the film-chamber lock. The back cover can be opened. When the camera is open, gently pull the film off the take-up spool and rewind it back into the cartridge.

Contact an authorized Konica Minolta service facility.

# CARE AND STORAGE

## OPERATING CONDITIONS

- This camera is designed for use from -20° to 50°C (4 to 122 °F).
- Never leave your camera where it may be subjected to extreme temperatures such as in the glove compartment of a car.
- The data panel response time will be slow at cold temperatures. The display will temporarily darken at high temperatures, but will be restored when the temperature normalizes.
- This camera is not waterproof or splashproof. When using the camera in the rain, protect the camera and lens.
- Never subject the camera to extreme humidity.
- To prevent condensation from forming, place the camera in a sealed plastic bag when bringing it from cold environment to a warm one. Allow it to come to room temperature before removing it from the bag.
- The low-battery indicator may appear even with fresh batteries depending on the storage conditions. To restore camera power, turn the camera on and off several times.
- Battery capacity decreases at colder temperatures. Keep your camera and spare batteries in a warm inside pocket when shooting in cold weather. Batteries will regain some of their capacity when warmed to normal operating temperature.

## STORAGE

When storing your camera for extended periods:

- Always attach the protective caps.
- Store in a cool, dry, and well-ventilated area away from dust and chemicals such as moth balls. For long periods, place the camera in an airtight container with a silica gel drying agent.
- Periodically release the camera's shutter to keep it operating properly.
- Before using the camera after prolonged storage, check that it is operating properly.



## CLEANING

- If the camera or lens barrel is dirty, wipe it gently with a soft, clean, dry cloth. If the camera or lens comes in contact with sand, gently blow away loose particles - wiping may scratch the surface.
- To clean the lens surface, first brush away any dust or sand then gently wipe the lens with a cloth or tissue designed for optics. Use lens cleaning fluid if necessary.
- Never place lens fluid directly on the lens.
- Never touch the interior of the camera, especially the shutter and mirror, doing so may impair their alignment and movement.
- Dust on the mirror will not affect the exposure but may affect the focus. Use a blower brush to remove dust from or around the mirror.
- Never use compressed air to clean the camera's interior; it may damage sensitive internal components.
- Never use organic solvents to clean the camera.
- Never touch the lens surface with your fingers.

## BEFORE IMPORTANT EVENTS

- Check the camera's operation carefully, or take test photographs before an event or journey.
- Konica Minolta is not responsible for any loss that may occur due to an equipment malfunction.

## QUESTIONS AND SERVICE

- If you have questions about your camera, contact your local camera dealer or write to the Konica Minolta distributor in your area.
- Before shipping your camera for repair, please contact an authorized Konica Minolta service facility for instructions.

# TECHNICAL SPECIFICATIONS

Camera type:	35mm SLR with built-in flash, autoexposure, and action predictive autofocus.
Lens mount:	Minolta A-type bayonet mount
Viewfinder:	SLR roof mirror type, 90% field of view. Magnification: 0.7X
Shutter type:	Electronically-controlled, vertical-traverse, focal-plane type.
Shutter speeds:	30 - 1/2000s, bulb
Flash sync. speed:	1/90s
Focus system:	TTL phase-detection system, multi metering with crosshair type CCD line sensor metering cell. Autofocus and manual focus modes.
AF sensitivity range:	EV -1 to 18 (ISO 100)
AF illuminator:	Built-in with range of 1.0 - 5.0m (3.3 - 16.4 ft.). Automatically activated in low-light and low-contrast situations.
AF control:	Single-shot, continuous, automatic AF-mode selection, and DMF.
Exposure modes:	P, PA, Ps, A, S, M, and 5 Subject Program modes (Portrait, Landscape, Close-up, Sports, Night Portrait)
Metering:	TTL metering, direct TTL flash metering.
Metering cell:	14-segment honeycomb-pattern SPC for ambient light and 4-segment flash-metering SPC for flash.
Metering range:	14-segment metering: EV 1 - 20, Spot metering: EV 4 - 20 (ISO 100, f/1.4 lens)
Film-speed setting:	Automatic: ISO 25 - 5000 (DX-coded film) Manual: ISO 6 - 6400 in 1/3 Ev increments. Flash: ISO 25 - 1000.

Film loading:	Auto load
Rewind:	Auto and manual rewind.
Frame counter:	Shows number of exposures taken.
Flash guide number:	16 (ISO 100 in meters) 52 (ISO 100 in feet)
Flash coverage:	28mm focal length lens.
Power source:	Two CR2 lithium batteries
Battery performance:	

	Condition A		Condition B	
Flash use	20°C/68°F	-10°C/14°F	20°C/68°F	-10°C/14°F
0%	30 rolls	24 rolls	45 rolls	35 rolls
50%	14 rolls	11 rolls	18 rolls	14 rolls
100%	9 rolls	7 rolls	11 rolls	9 rolls

Based on 24 exposure rolls taken at a rate of two rolls per month. Battery performance varies with conditions.

Condition A: Minolta 28-100 f/3.5-5.6 lens focused from infinity to 2m (6.6 ft.) three times and the shutter-release button held partway down for ten seconds before each exposure.

Condition B: Minolta 28-100 f/3.5-5.6 lens focused from infinity to 2m (6.6 ft.) and the shutter-release button held partway down for five seconds before each exposure.

Dimensions: 135.0 (W) x 92.0 (H) x 66.5 (D) mm  
5.3 (W) x 3.6 (H) x 2.6 (D) in.

Weight : 375g (13.2oz) without camera battery.

Specifications and accessories are based on the latest information available at the time of printing and are subject to change without notice.

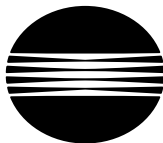

**KONICA MINOLTA**

**KONICA MINOLTA PHOTO IMAGING, INC.**

© 2004 Konica Minolta Photo Imaging, Inc. under the  
Berne Convention and the Universal Copyright Convention.



9222-2166-11 NI-B403  
Printed in China

## Free Manuals Download Website

<http://myh66.com>

<http://usermanuals.us>

<http://www.somanuals.com>

<http://www.4manuals.cc>

<http://www.manual-lib.com>

<http://www.404manual.com>

<http://www.luxmanual.com>

<http://aubethermostatmanual.com>

Golf course search by state

<http://golfingnear.com>

Email search by domain

<http://emailbydomain.com>

Auto manuals search

<http://auto.somanuals.com>

TV manuals search

<http://tv.somanuals.com>