

Thank you for purchasing the Minolta Dimâge RD 3000. Your new megapixel camera is a compact and lightweight, interchangeable lens SLR type digital still camera. Using revolutionary technology, your camera produces high-quality, high-resolution images quickly and easily. New and extraordinary features expand your image-capturing horizons.

- 2.7 million pixel dual CCD image sensor.
- Interchangeable lenses – cover focal lengths from 25 to 360 mm (35mm format equivalent).
- CompactFlash™ card removable media storage – so there is no limit on how many shots you can take.
- 2-inch colour LCD monitor – review images instantly.
- Real-time OS and multi-tasking speeds up image processing time.
- Prism-based infrared filtering – does not reduce the CCD's visible light sensitivity.
- Video-output – view camera images on the television.
- Sturdy, compact, lightweight body.
- Continuous drive mode – capture up to 5 frames at 1.5 frames per second with one press of the shutter-release button.
- PC terminal for sync-cord flash units.
- SCSI connector – a fast and convenient way to hook up directly to the computer.
- Uses AA-size NiMH batteries.

Please take the time to read through this instruction manual so you can enjoy all of its features.

For information on installing and operating the included software, please read the accompanying software instruction manual.

This manual contains information regarding products introduced before Jul., 1999. To obtain compatibility information for products released after this date, contact a Minolta Service Facility listed on the back cover of this manual.



Digital Camera: Dimâge RD3000



Tested To Comply  
With FCC Standards

FOR HOME OR OFFICE USE

This mark on your camera certifies that this camera meets the requirements of the EU (European Union) concerning interference causing equipment regulations. CE stands for Conformité Européenne (European Conformity).

This device complies with Part 15 of the FCC Rules. Operation is subject to the following two conditions: (1) This device may not cause harmful interference, and (2) this device must accept any interference received, including interference that may cause undesired operation.

Tested by the Minolta Corporation  
101 Williams Drive, Ramsey, New Jersey 07446, U.S.A.

This Class B digital apparatus complies with Canadian ICES-003.

Cet appareil numérique de la classe B est conforme à la norme NMB-003 du Canada.

Do not remove the ferrite cores from the cables.

- Digita™ and the Digita™ logo are licensed trademarks or registered trademarks of FlashPoint Technology Inc. in the U.S. and other countries.
- Other company names and product names are the trademarks and registered trademarks of their respective companies.

## CUTIONS FOR SAFE USE OF DIGITAL CAMERA RD3000.

### **WARNING**

Use caution, accidents may occur when using this product near young children.

Keep batteries or things that could be swallowed away from young children. Contact a doctor immediately if an object is swallowed.

Immediately remove the batteries and discontinue use if...

- the camera is dropped or subjected to an impact in which the interior is exposed.
- the product emits a strange smell, heat, or smoke.

Do not disassemble. Electric shock may occur if a high voltage circuit inside the camera is touched. Take your camera to a Minolta Service Facility when repairs are required.

Do not look directly at the sun through the viewfinder.

### **CAUTION**

The heat of the camera rises with extended periods of use. Use caution when handling the camera.

Thank you for purchasing the Minolta Dimâge RD 3000. Your new megapixel camera is a compact and lightweight, interchangeable lens SLR type digital still camera. Using revolutionary technology, your camera produces high-quality, high-resolution images quickly and easily. New and extraordinary features expand your image-capturing horizons.

- 2.7 million pixel dual CCD image sensor.
- Interchangeable lenses – cover focal lengths from 25 to 360 mm (35mm format equivalent).
- CompactFlash™ card removable media storage – so there is no limit on how many shots you can take.
- 2-inch colour LCD monitor – review images instantly.
- Real-time OS and multi-tasking speeds up image processing time.
- Prism-based infrared filtering – does not reduce the CCD's visible light sensitivity.
- Video-output – view camera images on the television.
- Sturdy, compact, lightweight body.
- Continuous drive mode – capture up to 5 frames at 1.5 frames per second with one press of the shutter-release button.
- PC terminal for sync-cord flash units.
- SCSI connector – a fast and convenient way to hook up directly to the computer.
- Uses AA-size NiMH batteries.

Please take the time to read through this instruction manual so you can enjoy all of its features.

For information on installing and operating the included software, please read the accompanying software instruction manual.

This manual contains information regarding products introduced before Jul., 1999. To obtain compatibility information for products released after this date, contact a Minolta Service Facility listed on the back cover of this manual.



Digital Camera: Dimâge RD3000



Tested To Comply  
With FCC Standards

FOR HOME OR OFFICE USE

This mark on your camera certifies that this camera meets the requirements of the EU (European Union) concerning interference causing equipment regulations. CE stands for Conformité Européenne (European Conformity).

This device complies with Part 15 of the FCC Rules. Operation is subject to the following two conditions: (1) This device may not cause harmful interference, and (2) this device must accept any interference received, including interference that may cause undesired operation.

Tested by the Minolta Corporation  
101 Williams Drive, Ramsey, New Jersey 07446, U.S.A.

This Class B digital apparatus complies with Canadian ICES-003.

Cet appareil numérique de la classe B est conforme à la norme NMB-003 du Canada.

Do not remove the ferrite cores from the cables.

- Digita™ and the Digita™ logo are licensed trademarks or registered trademarks of FlashPoint Technology Inc. in the U.S. and other countries.
- Other company names and product names are the trademarks and registered trademarks of their respective companies.

# TABLE OF CONTENTS

<b>FOR PROPER AND SAFE USE</b> .....	<b>2</b>
<b>BEFORE YOU BEGIN</b> .....	<b>3</b>
<b>TABLE OF CONTENTS</b> .....	<b>4</b>
 <b>INTRODUCTION</b>	
<b>NAMES OF PARTS</b> .....	<b>10</b>
<b>Camera Body</b> .....	<b>10</b>
<b>Left side of Body</b> .....	<b>12</b>
<b>Bottom of Body</b> .....	<b>12</b>
<b>Data Panel</b> .....	<b>13</b>
<b>Viewfinder</b> .....	<b>14</b>
<b>GETTING STARTED RIGHT AWAY</b> .....	<b>16</b>
<b>Preparation</b> .....	<b>16</b>
<b>Recording</b> .....	<b>17</b>
<b>Play</b> .....	<b>18</b>
<b>Deleting Images</b> .....	<b>18</b>
<b>PREPARATION</b> .....	<b>20</b>
<b>Holding Strap</b> .....	<b>20</b>
Attaching The Holding Strap .....	20
<b>Inserting Batteries</b> .....	<b>22</b>
Low Battery Warning .....	23
Auto Power Off .....	24
<b>Using the AC Adapter(AC-2)</b> .....	<b>25</b>
<b>Attaching and Removing the Lens</b> .....	<b>26</b>
Attaching the Lens .....	26
Removing the Lens .....	27
<b>Setting the Date/Time</b> .....	<b>28</b>
<b>Diopter Adjustment</b> .....	<b>31</b>
<b>Compact Flash Card</b> .....	<b>32</b>
Inserting the Compact Flash Card .....	32
Removing the Compact Flash Card .....	33

# TABLE OF CONTENTS

## RECORDING

<b>BASIC OPERATION</b> .....	<b>36</b>
Taking Pictures in Automatic Mode .....	36
Selecting the Record Setting .....	38
Quick View .....	39
<b>Image Quality Selection</b> .....	<b>40</b>

<b>FOCUS DETAILS</b> .....	<b>42</b>
<b>Focus Signals</b> .....	<b>42</b>
<b>Special Focusing Situations</b> .....	<b>43</b>
<b>Focus Hold</b> .....	<b>44</b>
<b>Direct Manual Focus (DMF)</b> .....	<b>45</b>
<b>Manual Focus</b> .....	<b>46</b>

<b>EXPOSURE</b> .....	<b>47</b>
<b>Exposure Compensation</b> .....	<b>47</b>
<b>Spot Metering</b> .....	<b>49</b>
<b>Exposure Modes</b> .....	<b>51</b>
P Mode – Programmed Exposure .....	51
A Mode – Aperture Priority .....	52
S Mode – Shutter Priority .....	54
M Mode – Manual Operation .....	56

# TABLE OF CONTENTS

<b>ADDITIONAL FEATURES</b> .....	<b>58</b>
<b>White Balance</b> .....	<b>58</b>
Custom White Balance – Creating a Setting .....	60
<b>Continuous Drive Mode</b> .....	<b>62</b>
<b>Self-timer</b> .....	<b>66</b>
<b>Remote Control (Sold Separately)</b> .....	<b>68</b>
Remote Control Mode .....	68
Focus Hold in Remote Control Mode .....	70
Changing the Remote Control Battery .....	71
<b>Program-reset button</b> .....	<b>72</b>
<b>Counter button</b> .....	<b>73</b>
<b>Changing ISO Sensitivity</b> .....	<b>74</b>
<b>Formatting a Compact Flash Card</b> .....	<b>76</b>
<b>FLASH</b> .....	<b>78</b>
<b>Using Flash</b> .....	<b>78</b>
Attaching an Accessory Flash .....	78
Flash Signals .....	79
<b>PC Terminal</b> .....	<b>80</b>
<b>Using Flash in P, A, S, and M Modes</b> .....	<b>81</b>
<b>Slow Shutter Sync</b> .....	<b>82</b>
<b>Flash Compensation</b> .....	<b>84</b>
<b>Wireless/Remote Off-camera Flash</b> .....	<b>85</b>

# TABLE OF CONTENTS

## PLAY

<b>VIEWING IMAGES</b> .....	<b>88</b>
<b>Viewing Full Screen</b> .....	<b>88</b>
<b>Viewing AN IMAGE Index</b> .....	<b>89</b>
<b>CHANGING THE INDEX DISPLAY</b> .....	<b>93</b>
<b>DELETING A SINGLE IMAGE</b> .....	<b>94</b>
<b>CLEARING UNPROTECTED IMAGES</b> .....	<b>96</b>
<b>PROTECTING IMAGES</b> .....	<b>98</b>
<b>UNPROTECTING IMAGES</b> .....	<b>100</b>
<b>ADJUSTING THE LCD MONITOR BRIGHTNESS/CONTRAST</b> .....	<b>102</b>
<b>CHECKING FLASH CARD STATUS</b> .....	<b>105</b>
<b>VIDEO OUT</b> .....	<b>107</b>
<b>REPLACING THE CLOCK BACKUP BATTERY</b> .....	<b>108</b>
<b>CLEANING THE LENS IN THE RELAY OPTICAL SYSTEM</b> .....	<b>110</b>

## APPENDIX

<b>ACCESSORY INFORMATION</b> .....	<b>114</b>
Lenses .....	114
Flashes .....	114
Other .....	114
<b>File Size/Card Capacity</b> .....	<b>116</b>
<b>Camera Warnings</b> .....	<b>117</b>
<b>Troubleshooting</b> .....	<b>120</b>
<b>Care and Storage</b> .....	<b>122</b>
<b>Technical Details</b> .....	<b>124</b>





# INTRODUCTION

# NAMES OF PARTS

## CAMERA BODY

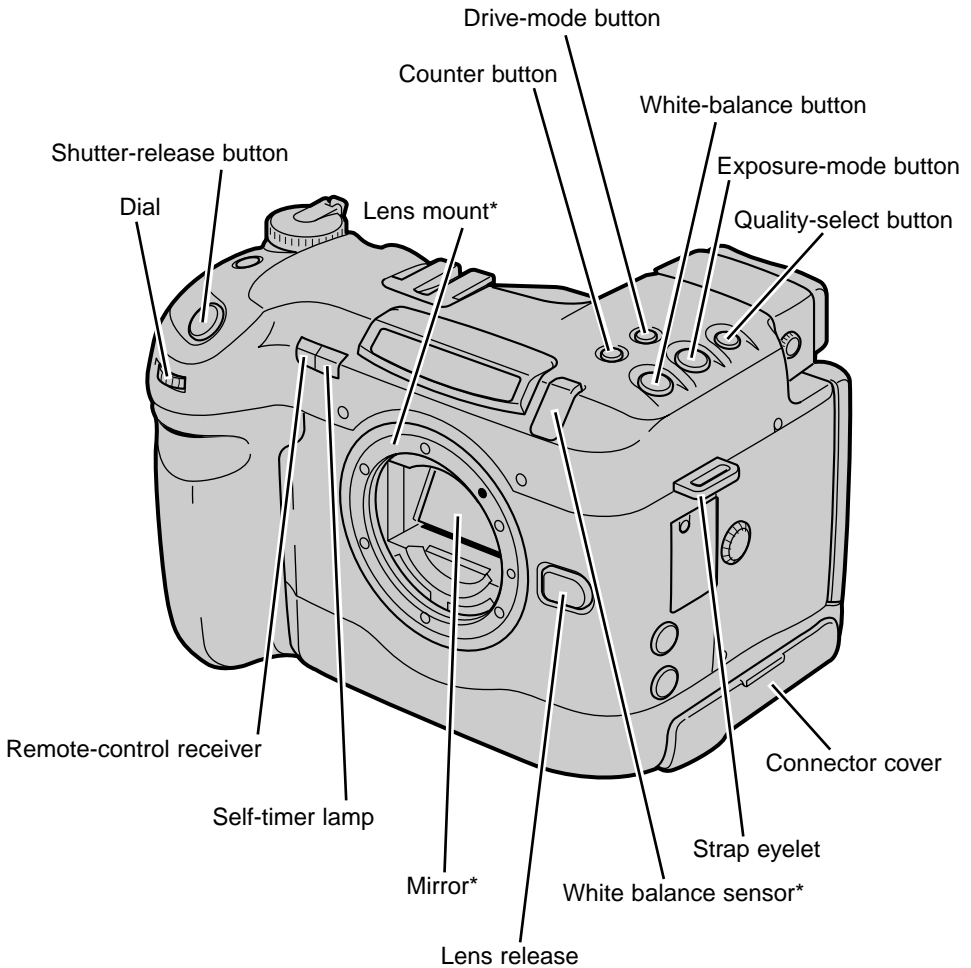

\*Do not touch.

# NAMES OF PARTS

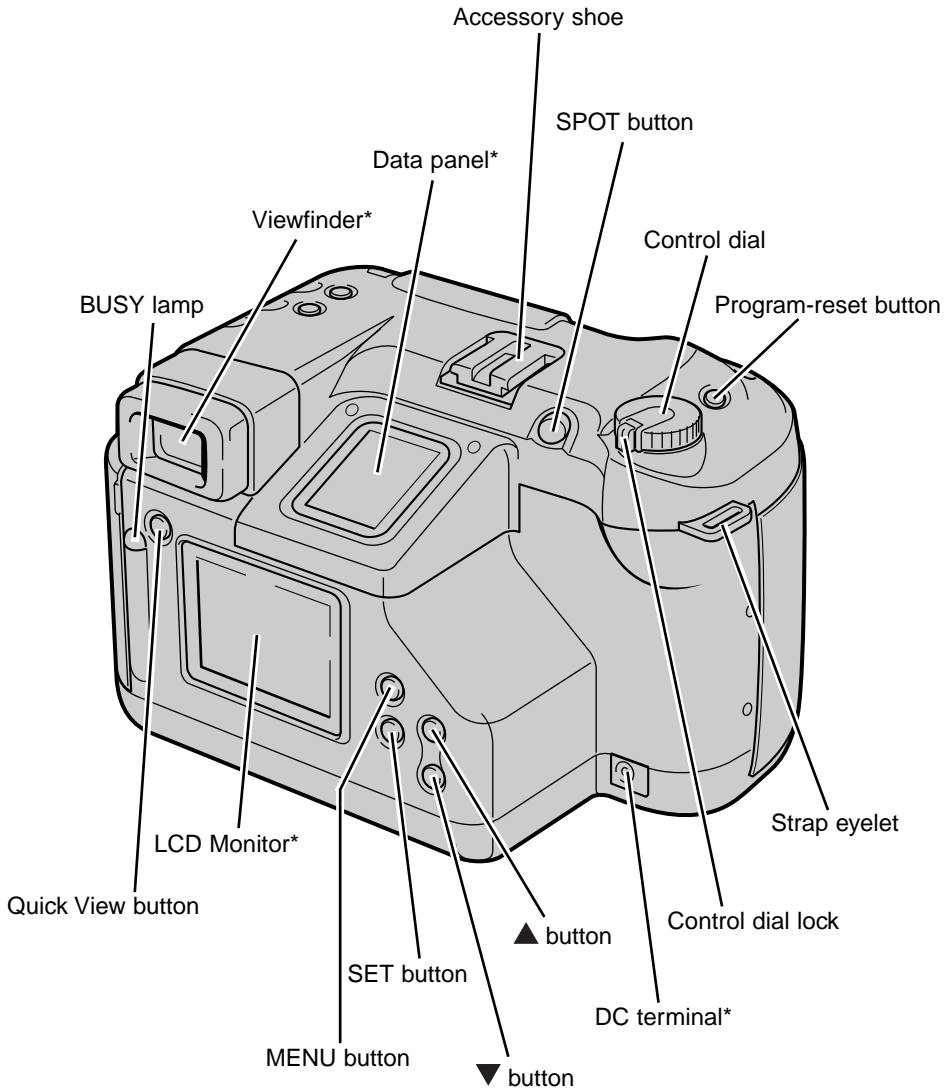

# NAMES OF PARTS

## LEFT SIDE OF BODY

With connector cover open

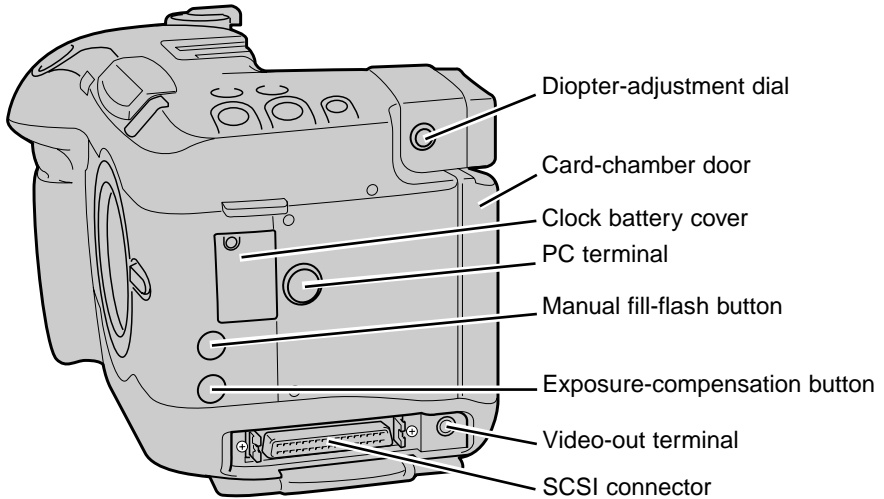

## BOTTOM OF BODY

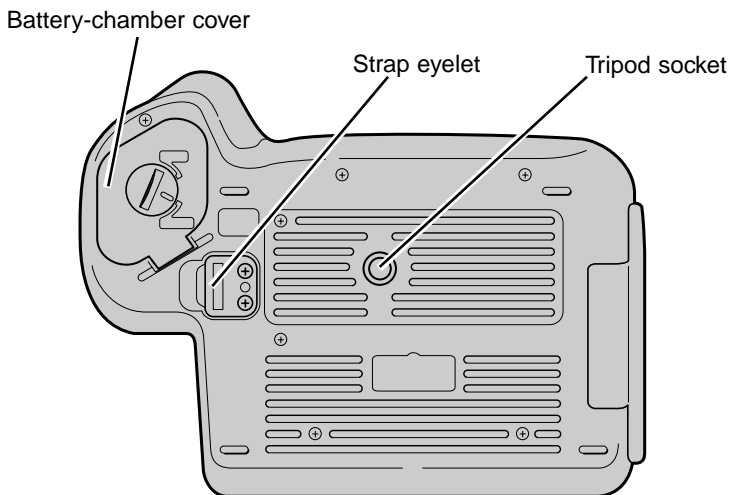

# NAMES OF PARTS

## DATA PANEL

The following diagram shows all items displayed to aid the explanation.

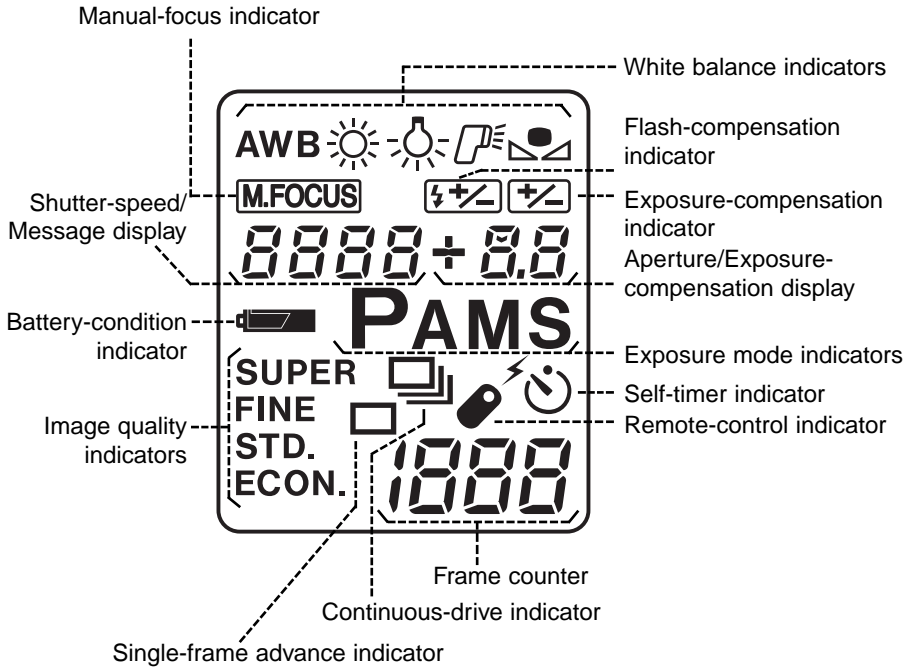

# NAMES OF PARTS

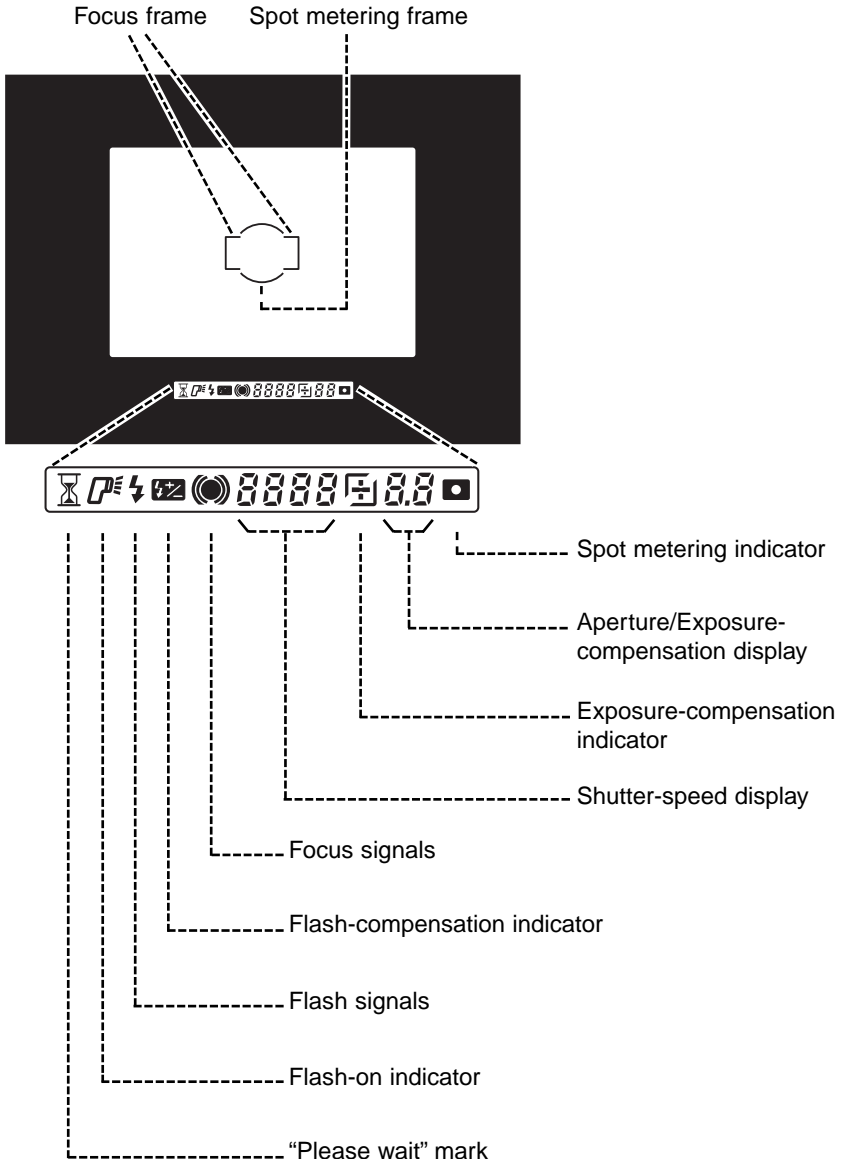

## VIEWFINDER

The following diagram shows all items displayed to aid the explanation.



## NAMES OF PARTS





Please wait mark 

 LIT	WAIT. SHUTTER LOCKED.
 EXTINGUISHED	READY TO SHOOT.

Focus signals 

● LIT	IN FOCUS.
 LIT	IN FOCUS. FOCUS CHANGES WITH MOVEMENT OF SUBJECT.
( ) LIT	FOCUSING. SHUTTER LOCKED.
● BLINKING	NOT FOCUSED. SHUTTER LOCKED.

Flash-on indicator , Flash signals 

 LIT	READY FOR FLASH PHOTOGRAPHY.
 AND  LIT	FLASH CHARGED.
 BLINKING (AFTER TAKING PHOTO)	FLASH OUTPUT WAS SUFFICIENT TO PROVIDE CORRECT EXPOSURE.

## GETTING STARTED RIGHT AWAY

### PREPARATION

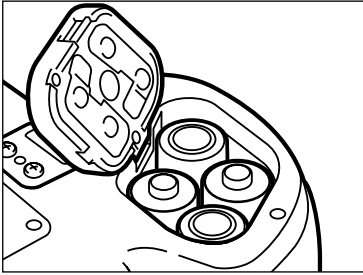

- 1** Insert the batteries or connect the AC adapter (see pages 22, 25).

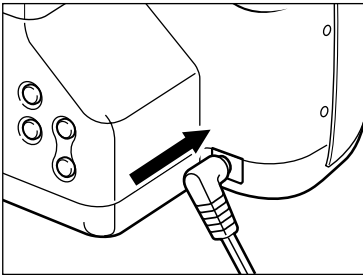

- 2** Attach the lens (see page 26).

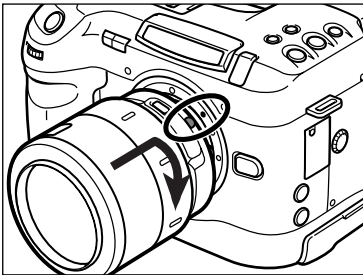

- 3** Insert the compact flash card (see page 32).

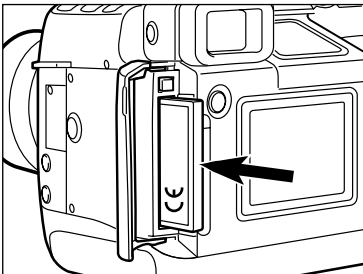



## RECORDING

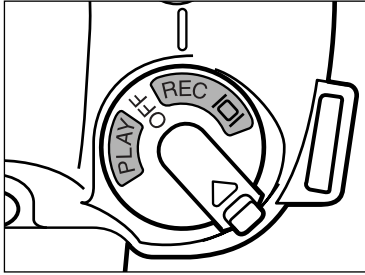

- 1 Turn the Control dial to REC or ID.

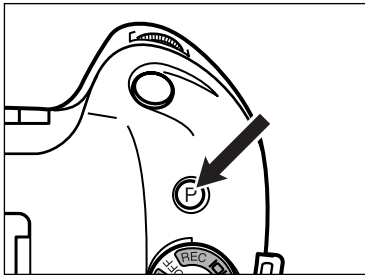

- 2 Press the Program-reset button.
  - This puts the camera in full-auto mode.



- 3 Frame the image in the viewfinder.
  - Place the focus frame on your subject.

- 4 Press the shutter-release button partway down.
  - Autofocus will activate and ● will glow in the viewfinder if focus is confirmed and locked.

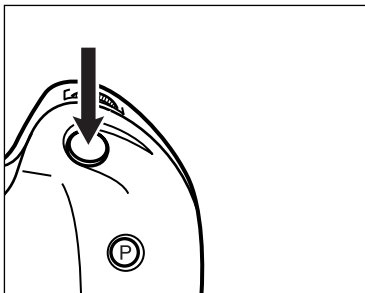

- 5 Press the shutter release button all-the-way down to take the picture.
  - The busy lamp and the frame counter in the data panel will blink while the recorded image is being written to memory.
  - In ID, the camera will display the image in the LCD monitor. In REC, press the Quick View button to see a brief display of the image.

## GETTING STARTED RIGHT AWAY

### PLAY

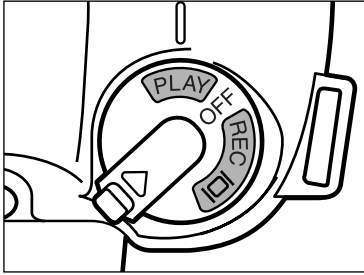

**1** Turn the Control dial to **PLAY**.

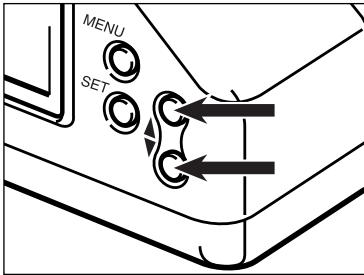

**3** Press the ▲ or ▼ button to scroll through the images.

### DELETING IMAGES

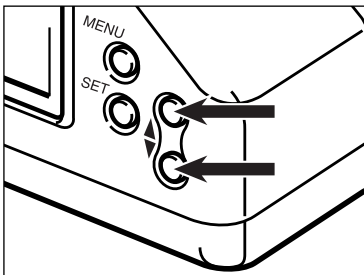

**1** Turn the Control dial to **PLAY**.

**2** Select the desired image.

- Press the ▲ or ▼ button until the image appears in the LCD monitor.

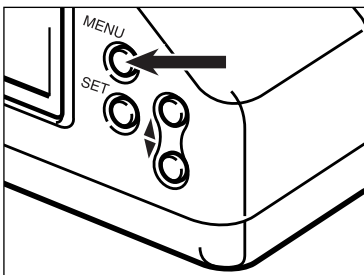

**3** Press the **MENU** button.

## GETTING STARTED RIGHT AWAY

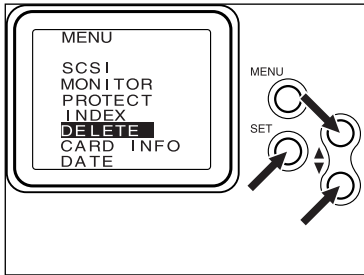

**4** Press the ▼ button until DELETE is highlighted.

**5** Press the SET button.

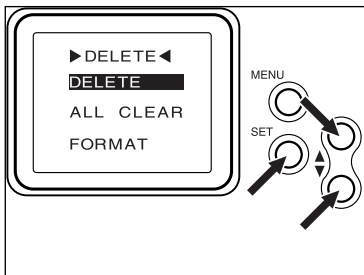

**6** Press the ▼ button until DELETE is highlighted.

**7** Press the SET button.  
• A confirmation screen will appear.

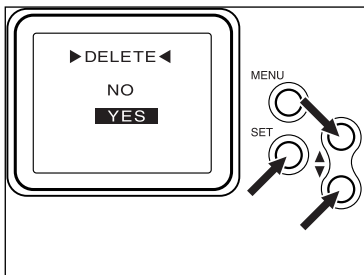

**8** Press the ▼ button until YES is highlighted.

**9** Press the SET button.  
• The LCD monitor will return to the PLAY screen after the image is deleted.

## PREPARATION

### HOLDING STRAP

Use the Holding Strap HC-RD1 for a more secure grip on the camera.

### ATTACHING THE HOLDING STRAP

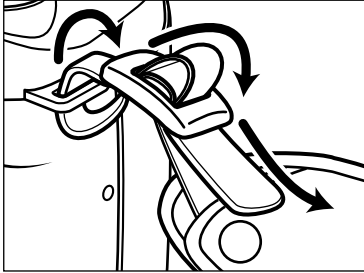

- 1 Pass the short tip of the holding strap through the camera's upper strap eyelet, then through the strap eyelet on the holding strap.

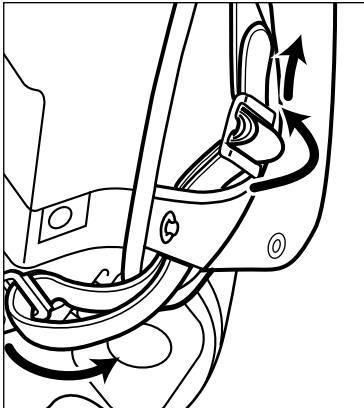

- 2 Pass the long tip of the holding strap through the camera's bottom eyelet, then through the buckle on the holding strap.

## PREPARATION

- The holding strap may be fitted to three locations on this camera. Use the strap eyelet at the left side of the back of the camera when attaching the camera neck strap or wide strap (available separately) designed for Minolta single-lens reflex (SLR) cameras.

## PREPARATION

### INSERTING BATTERIES

Fully charge all four of the supplied NiMH batteries before use.

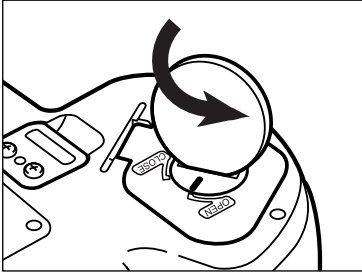

**1** Using a coin or similar object, turn the battery-chamber lock counter-clockwise.

**2** Open the battery chamber.

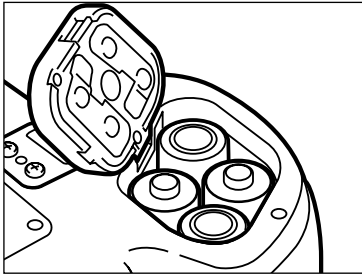

**3** Insert the batteries as indicated by the + and - marks.

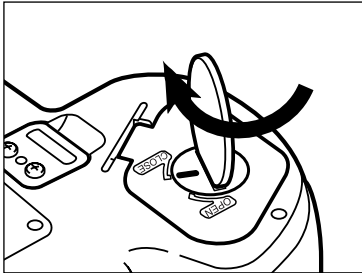



**4** Close the cover, then turn the battery-chamber cover to **CLOSE** to lock it.

- To prevent damage to the cover, do not set the camera down on a surface with the cover open.

## LOW BATTERY WARNING

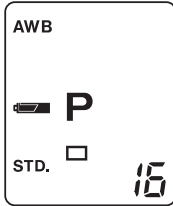
Your camera is equipped with an automatic battery-condition indicator.



**Full-Battery symbol**  – Each time the camera is turned on, the battery-condition indicator will briefly appear in the data panel.  indicates the battery power is full.

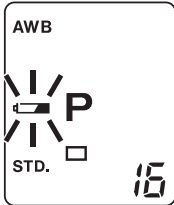

**Blinking low battery**  – Power is low, but all functions are operational. The battery will have to be replaced very soon.

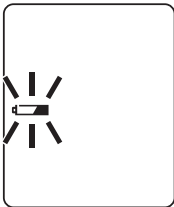

**Blinking low-battery alone and shutter locks** – Power is insufficient for camera operation.

- If no display appears, replace the batteries or check that they are inserted correctly.

## ***AUTO POWER OFF***

### **Control Dial set to PLAY**

To save power, the LCD monitor will shut down after approximately 10 minutes if the camera is not used (unless the camera is connected to the PC). Press the Quick View button to switch on the monitor again.

### **Control Dial set to REC or**

The Auto Power Off function does not work with this setting. If the camera is left unused for more than 8 minutes with a compact flash card warning (Card Full, Card Error, Non-compatible Card) on the data panel, the panel is shut down. Return the Control Dial to the OFF position, and then turn it to REC or .



## PREPARATION

### USING THE AC ADAPTER (AC-2)

Use the AC Adapter AC-2 allows the camera to receive power from an electrical outlet. Use of the AC adapter is recommended to conserve batteries during periods of heavy use. It is also recommended when interfacing the camera with the computer.

**Always turn the Control Dial to OFF, and switch the digital camera power supply off, before changing from batteries to AC adapter or vice versa. Do not change the power supply while the camera is ON.**

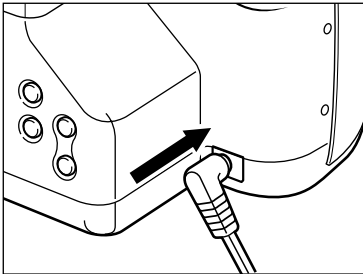

**1** Insert the mini plug into the camera's AC terminal.

**2** Insert the AC plug into an electrical outlet.

## PREPARATION

### ATTACHING AND REMOVING THE LENS

#### ATTACHING THE LENS

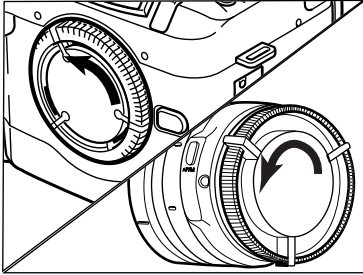

- 1 Remove the camera body cap and rear lens cap as shown.

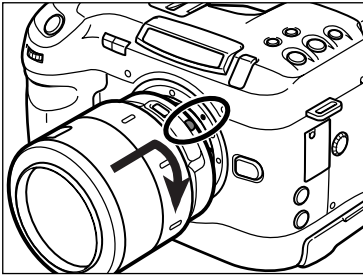

- 2 Align the red mounting dot on the lens with the red dot on the mount.
- 3 Turn the lens clockwise until it clicks.

- Do not insert the lens at an angle.
- Do not press the lens release when attaching the lens.

## PREPARATION

### REMOVING THE LENS

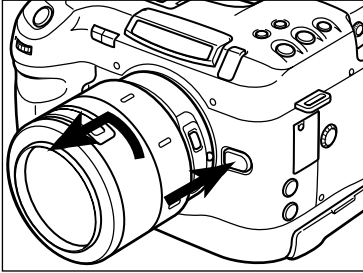

- 1** Press the lens release and turn the lens counter-clockwise until it stops.
- 2** Gently remove the lens from the mount and replace the caps.

- Do not force the lens if it does not turn smoothly.
- Do not touch the inside of the camera, especially the lens contact and mirror.
- Remove dust, dirt, and moisture from the lens mount area before attaching or removing a lens.

## PREPARATION

### SETTING THE DATE/TIME

This camera records the date and time an image was captured. For your reference, set the date and time for accuracy.

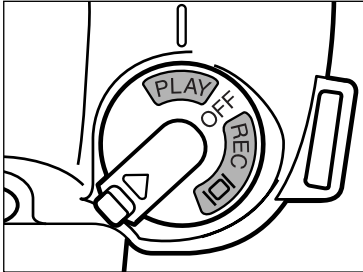

- 1** With the Control dial lock button pushed in the  $\triangle$  direction, turn the Control dial to the right to the PLAY position.

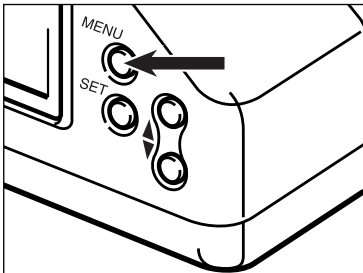

- 2** Press the MENU button on the back of the camera.
  - The top menu will appear.

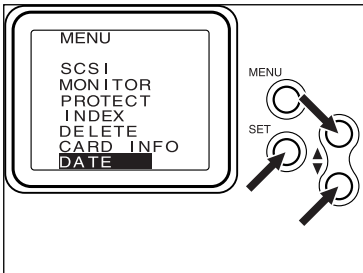

- 3** Press the  $\blacktriangle$  or  $\blacktriangledown$  button a number of times to highlight DATE, and press the SET button.
  - The DATE menu will appear.

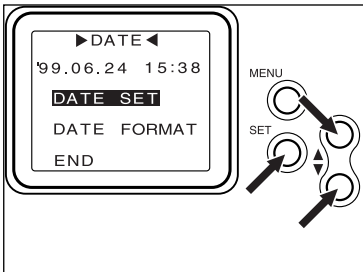

- 4** Press the  $\blacktriangle$  or  $\blacktriangledown$  button to highlight DATE SET on the DATE menu, and press the SET button.
  - The DATE SET menu will appear.
  - Skip this adjustment if the date and time are correct, and go directly to [8].

## PREPARATION

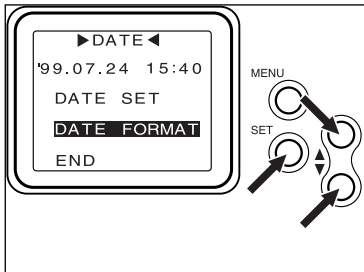
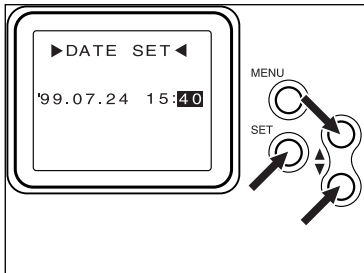
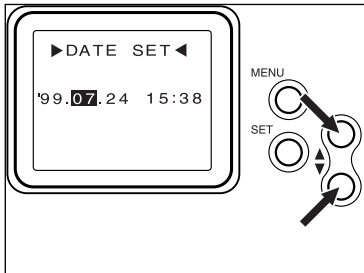
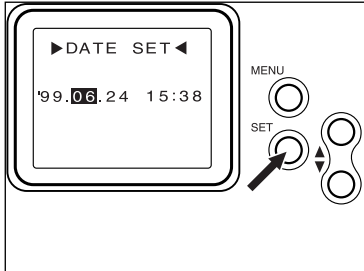

- 5** Press the SET button as many times as required to highlight the value to be changed.

- Press the SET button repeatedly to move the highlight to year → month → day → hour → minute.

- 6** Press the ▲ or ▼ button to adjust the setting.

- 7** Once the Minute value has been changed, press the SET button.

- The internal clock begins operation, and the system returns to the DATE menu.

- 8** Press the ▲ or ▼ button to highlight DATE FORMAT on the DATE menu, and press the SET button.

- The DATE FORMAT menu will appear.
- Skip this adjustment if the date format is correct, and go directly to [11].

## PREPARATION

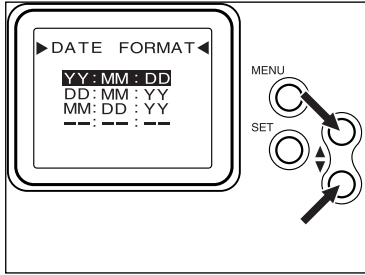

- 9** Press the ▲ or ▼ button to highlight the desired date format.

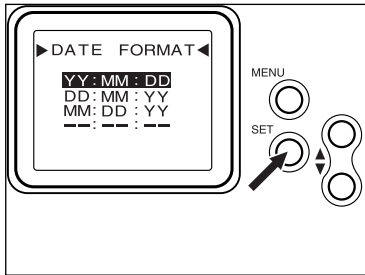

- 10** Press the SET button.
- The LCD monitor returns to [1].

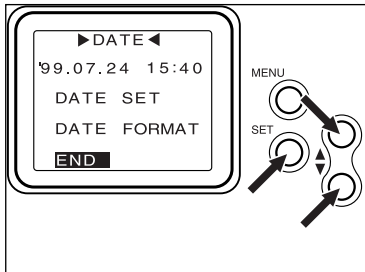

- 11** Press the ▲ or ▼ button to highlight END on the DATE menu, and press the SET button.
- The LCD monitor returns to [1].

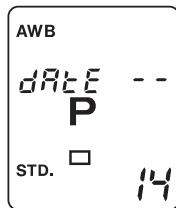

The clock backup battery is low if the item at left appears on the data panel. Read the section on page 108, and then replace the battery.

## PREPARATION

### DIOPTER ADJUSTMENT

If you are near or far sighted, you can use this control to adjust the eyepiece for your eyesight. The diopter adjustment range is from -4 to +2 dioptres.

### ADJUSTING THE DIOPTER

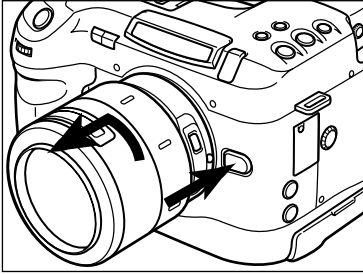

- 1** Remove the lens (see page 27), and direct the camera body towards the light.

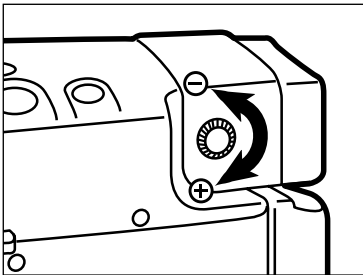

- 2** Look through the viewfinder and turn the viewfinder dial until the focus frame is clearly visible.

## PREPARATION

### COMPACT FLASH CARD

Your camera requires a compact flash card to be inserted before capturing images.

- Always ensure that the BUSY lamp is extinguished or not blinking before inserting or removing the compact flash card from the camera.
- The data in the card will be lost, or the card itself may be damaged, if the compact flash card is removed while the BUSY lamp is lit.

### INSERTING THE COMPACT FLASH CARD

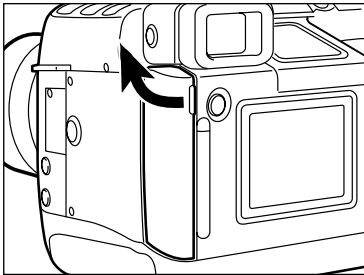

**1** Open the card-chamber door.

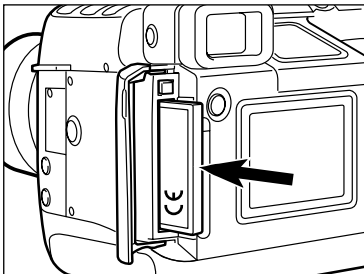

**2** Insert the compact flash card into the card slot, pushing it in until the card-release lever pops out.

- Insert the card so the back label faces away from the camera.
- Push the card in straight, not at an angle.
- Wrong direction: If the card stops mid-way, confirm the direction of the card. Do not force the card.

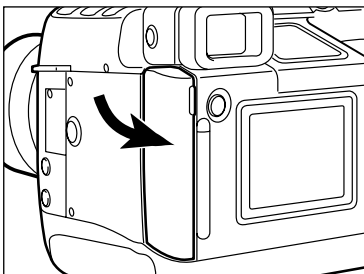

**3** Close the card-chamber door.



## REMOVING THE COMPACT FLASH CARD

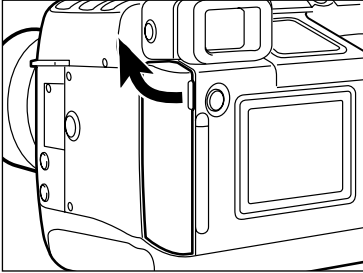

**1** Open the card-chamber door.

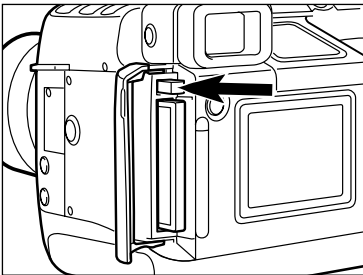

**2** Press the card-release button to eject the card.

**3** Pull the memory card straight out.

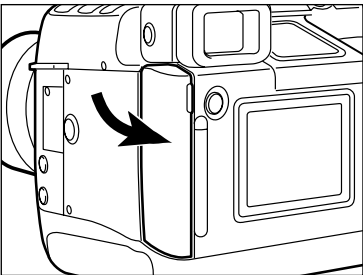

**4** Close the card-chamber door after removing the card.



# RECORDING

## BASIC OPERATION

### TAKING PICTURES IN AUTOMATIC MODE

Full Auto mode is the camera's standard operating mode and is suited for use in almost any situation. When the Program-reset button is pressed, the camera is returned to fully-automatic operation. See page 72.

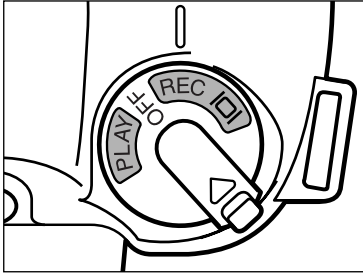

- 1 With the Control dial lock button pushed in the  $\triangle$  direction, turn the Control dial to REC or P.

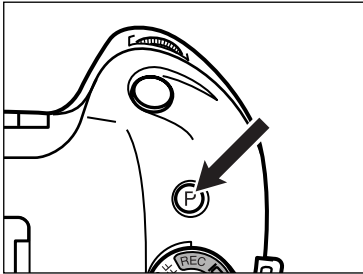

- 2 Press the Program-reset button to set the camera to Full Auto mode.

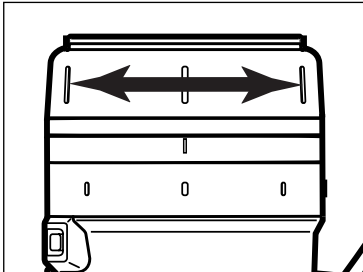

- 3 Turn the zoom ring on the lens until the subject is the desired size in the viewfinder (this applies only to the zoom lens).



- 4 Center your subject in the focus frame [ ] and press the shutter-release button partway down to activate autofocus. ● or (●) will glow when the subject is in focus.



## BASIC OPERATION

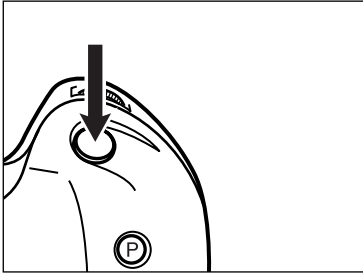

**5 Press the shutter-release button all-the-way down to take the picture.**

- The images taken are saved to the compact flash card when photography is complete. While the images are being saved to the compact flash card the BUSY lamp is lit, and the frame counter on the data panel blinks. To prevent loss of image data, do not remove the AC adapter plug from the socket, or remove the compact flash card from the camera, until all the images have been saved.
- When all the images have been saved to the compact flash card the BUSY lamp is extinguished, and the frame counter on the data panel stops blinking.

	SAVING IMAGES	IMAGES SAVED
BUSY LAMP		
DATA PANEL		

## SELECTING THE RECORD SETTING

This camera has two settings for recording.

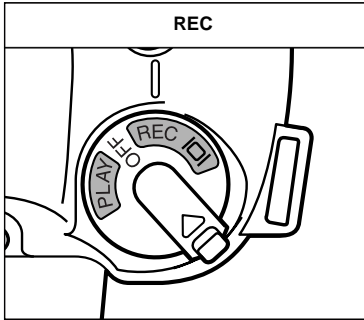

Images are saved in the compact flash card as they are taken, without being displayed on the LCD monitor.

Use this mode to take large numbers of images when the light source and the photography conditions are relatively stable. Press the QUICK VIEW button to display the previous picture taken on the LCD monitor for approximately 8 seconds.

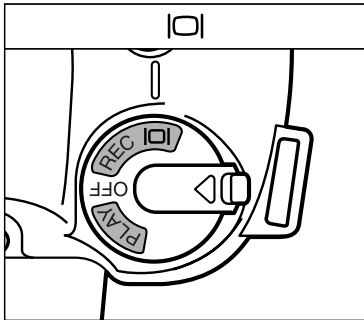

Each image is saved in the compact flash card as it is taken, and then displayed automatically on the LCD monitor for approximately 8 seconds.

Use this mode to check each image as it is taken.

## QUICK VIEW

The quick view button allows you see a preview of the captured image after it has been recorded.

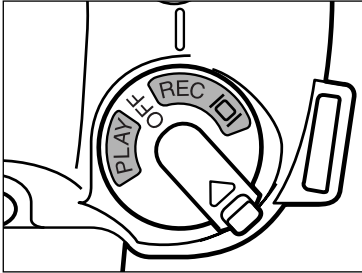

**1** In REC, take the picture.

**2** Wait until the image has been written to the compact flash card.

- The busy lamp and the counter display in the data panel will stop blinking.

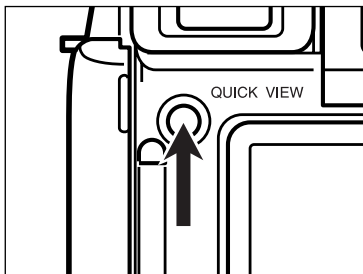

**3** Press the QUICK VIEW button.

- The recorded image will appear in the LCD monitor for approximately 8 seconds.

# BASIC OPERATION

## IMAGE QUALITY SELECTION

This digital camera supports four image quality modes – super-fine (SUPER FINE), fine (FINE), standard (STD.), and economy (ECON.).

Image quality is related to the rate of compression of the image. The rate of compression increases, and image quality decreases, in the order super-fine → fine → standard → economy.

The lower the rate of compression of the image, the higher its quality. If image quality is important, use the super-fine or fine mode. Note, however, that as the rate of image compression is low (no compression in the super-fine mode), the number of images able to be saved in the compact flash card will be less than in the economy or standard modes.

If economic use of the compact flash card is important (the need to save as many images as possible in it), use the economy or standard modes. Note, however, that as the rate of image compression is high, the quality of the images will be lower than in the super-fine or fine modes.

The rate of compression, the image recording format, and the number of images which may be saved in a 30MB compact flash card is shown below for the four image quality modes.

	<b>SUPER-FINE (SUPER FINE)</b>	<b>FINE (FINE)</b>	<b>STANDARD (STD.)</b>	<b>ECONOMY (ECON.)</b>
<b>RATE OF COMPRESSION</b>	Uncompressed	Approx. 1/5	Approx. 1/10	Approx. 1/15
<b>IMAGE RECORDING FORMAT</b>	Exif2-TIFF	Exif2-JPEG		
<b>NUMBER OF IMAGES WHICH MAY BE SAVED IN A 30MB COMPACT FLASH CARD</b>	Approx. 3pics	Approx. 17pics	Approx. 33pics	Approx. 52pics

- The number of images for every image quality are approximate values only. The actual numbers will vary with the scenes photographed.



## BASIC OPERATION

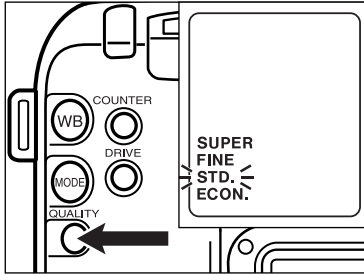

**1** In REC or , press and hold the **QUALITY** button.

- The image quality options will appear in the data panel.



**2** Turn the front dial until the desired quality setting blinks.

- Both SUPER and FINE blink when the super-fine mode is selected.

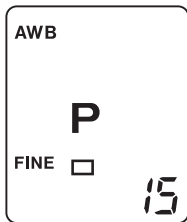

**3** Release the **QUALITY** button to set the change.

- Image quality may be changed while the capacity of CF card remains. One compact flash card may contain images of various image qualities.
- The image quality cannot be changed while the images are being saved to the compact flash card.
- The image quality setting is maintained when power is switched off (Control dial set to OFF).
- Changing the image quality will affect the remaining number of images which may be stored in the card. Selecting the super-fine or fine modes, in particular, will dramatically reduce this number. Press the COUNTER button to check the remaining number of images which may be stored in the card (see page 73).



# FOCUS DETAILS

## FOCUS SIGNALS

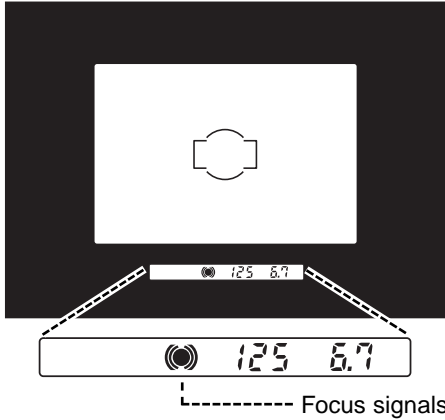
When the camera is set to autofocus (AF) mode, pressing the shutter-release button partway down will activate the autofocus system and one of the signals below will appear at the base of the viewfinder. In autofocus mode, the shutter will not release until the focus is confirmed.



Focus signals 

● LIT	In focus.
 LIT	In focus. Focus changes with movement of subject.
 LIT	Focusing. Shutter locked.
● BLINKING	Not focused. Shutter locked. Focus is not possible (shutter locked). Your subject is too close or is one of the special focusing situations described on the next page.

## SPECIAL FOCUSING SITUATIONS

In situations like those described below it may be difficult or impossible for the camera to focus accurately; you may need to use focus hold, direct-manual focus, or manual focus.

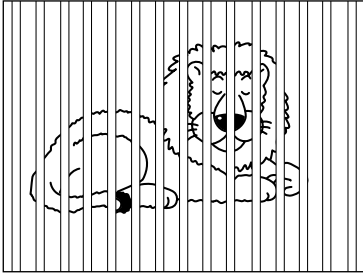

If two subjects at different distances overlap in the focus frame [ ].

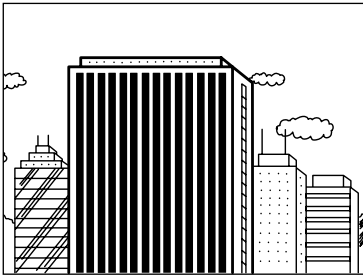

If a subject composed of alternating light and dark lines completely fills the focus frame [ ].

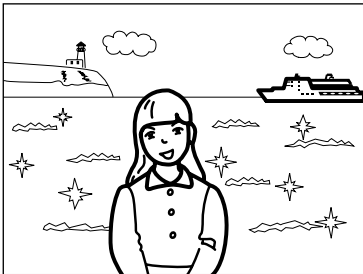

If the subject within the focus frame [ ] is very bright, or low in contrast.

## FOCUS HOLD

Focus hold should be used when you want to take a picture with your subject outside the focus frame [ ] or when autofocus is difficult to confirm.



- 1 Center your subject in the focus frame [ ] and press the shutter-release button partway down.

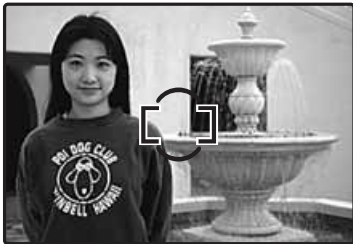

- 2 Continue to hold the shutter-release button partway down while you recompose your picture.

- 3 Press the shutter-release button all-the-way down to take the picture.

• Focus hold can only be used when • appears in the viewfinder.

### DIRECT MANUAL FOCUS (DMF)

DMF lets you adjust the focus manually without taking the camera out of autofocus mode.

- 1** With the camera in the autofocus mode, press the shutter-release button partway down to activate autofocus.

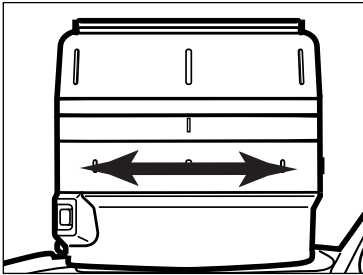

- 2** Without releasing the shutter-release button adjust the focus manually using the focusing ring on the lens.

- 3** Press the shutter-release button all-the-way down to take the picture.
  - will appear in the viewfinder to indicate when the subject in the focus frame is in focus.

- This function cannot be used on lenses without a focusing ring.
- Turning the focus ring will not change the focus unless the shutter button is pressed lightly at the same time.
- The focus icon ● is lit when the subject is in focus in the frame [ ].
- This function cannot be used if (●) or (C) are lit (i.e. when the subject is moving).

## MANUAL FOCUS

When autofocus is not suitable and focus hold is not possible, focus the lens manually. The autofocus system will monitor focus and indicate when a subject in the focus frame [ ] is in focus.

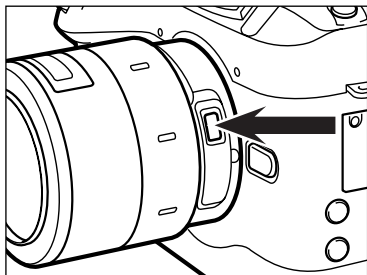

- 1 Press the focus-mode button, **M.FOCUS** will appear in the data panel.

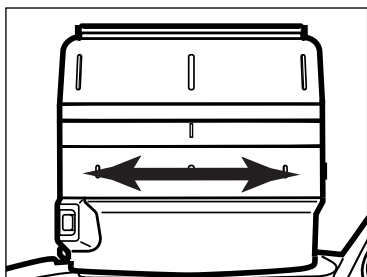
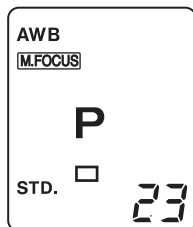

- 2 Turn the lens focusing ring until your subject appears sharp and focused.

- ● will appear in the viewfinder to indicate when the subject in the focus frame is in focus.
- The Minolta V lenses 28-56 mm f/4-5.6 2X zoom lens and the 25-150 mm f/4.5-6.3 4X zoom lens are autofocus only, manual focus is not possible.

## EXPOSURE COMPENSATION

This function lets you compensate exposure up to +/- 3 EV in 1/2 EV increments in situations where the camera's metering system may not be able to accurately determine exposure. More exposure is recommended for very bright scenes, such as snow or beach scenes. Less exposure is recommended when the scene is composed of mostly darker tones.



Over Exposure



Under Exposure



Metered Exposure

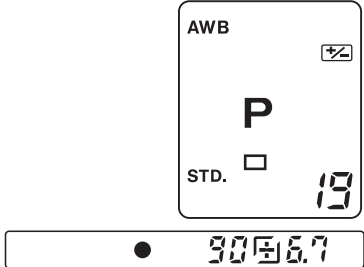
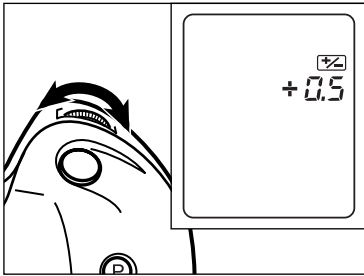
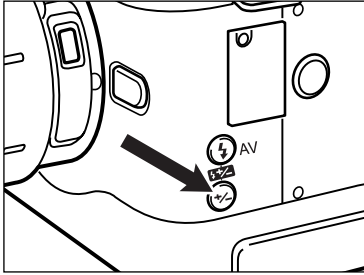

- 1 Press and hold the exposure-compensation button, then turn the front dial until the compensation value you want appears in the data panel.

- 2 Release the exposure-compensation button to enter the setting.
  - will remain in the data panel and viewfinder as a reminder that exposure compensation is set.
  - To cancel exposure compensation, perform the above procedure and select 0.0, or press the program-reset button.





## SPOT METERING

The standard metering mode for this camera uses a fourteen segment honeycomb pattern metering system to determine the correct exposure. When the exposure needs to be set according to a very small part of the scene, spot metering lets you use a single metering segment to determine correct exposure. When selected, only the center segment of the honeycomb pattern is used to read the brightness of the subject in the spot circle in the center of the viewfinder.

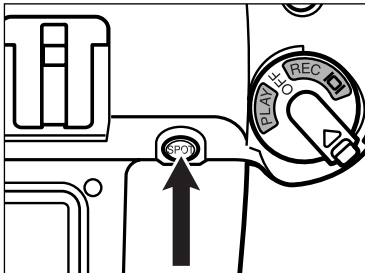

- 1 Move the area of the subject to be exposed into the spot metering frame.



- 2 Press and hold the SPOT button.
  -  will appear in the viewfinder.
  - Exposure will be locked until the spot button is released.



- 3 Recompose the picture, then press the shutter-release button all-the-way down to take the picture.



## EXPOSURE

- Press and hold the SPOT button to take pictures continuously with the same exposure.
- When the flash is used (L<sup>Fl</sup> lit in the viewfinder), pressing and holding the SPOT button will result in the slow-shutter sync facility being set (see page 82).
- When the  icon blinks the subject is either too bright or too dark for the metering range, and the correct exposure will not be possible.

## EXPOSURE MODES

This camera has four different exposure modes: Aperture-priority, Shutter-priority, Manual, and Program. The exposure modes allow you to tailor the degree of camera control needed to capture the desired image.

	MODE	EXPLANATION
<b>P</b>	Program Exposure Mode	Camera selects aperture and shutter speed
<b>A</b>	Aperture Priority Mode	Manually select aperture
<b>S</b>	Shutter Priority Mode	Manually select shutter speed
<b>M</b>	Manual Exposure	Manually select aperture and shutter speed

### **P MODE – PROGRAMMED EXPOSURE**

P mode is ideal when you want to give your full attention to the subject and give the camera control over exposure. For additional information on P mode, refer to Taking Pictures in Full Auto Mode.

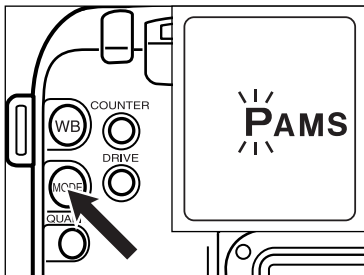

- 1** In REC or , press and hold the **MODE (exposure-mode) button**.
  - PAMS will appear in the data panel.

- 2** Turn the front dial until **P** blinks in the data panel, then remove your finger from the **MODE button**.
  - The camera is also returned to P mode when the Program-reset button is pressed.

## A MODE – APERTURE PRIORITY

In A mode, you select the aperture and the camera automatically sets the shutter speed required for proper exposure. A mode should be used when you want to control the range of sharpness (depth-of-field) in an image.

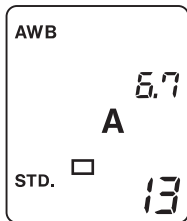
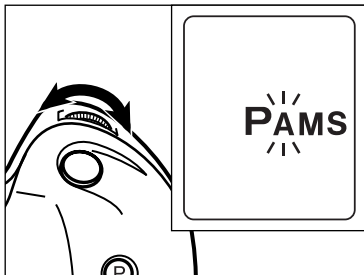
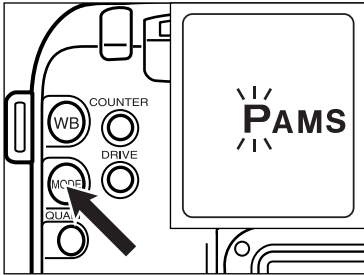

**1** In REC or , press and hold the **MODE** button.

- PAMS will appear in the data panel.
- The currently set exposure mode blinks on the data panel.

**2** Turn the front dial until **A** blinks in the data panel, then remove your finger from the **MODE** button.

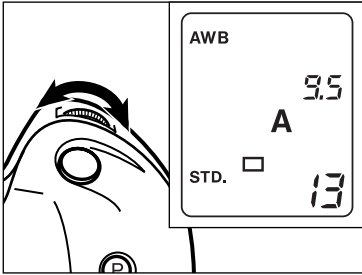

### 3 Turn the front dial to select the aperture.

- In the viewfinder, only the plane on which the camera is focused will appear sharp. The photographed image will have a depth-of-field corresponding to the aperture used.
- While the aperture range differs with the lens selected, the maximum aperture is F6.7, and the minimum aperture is F22.
- If 2000 or 2" (2 seconds) blinks, the required setting is beyond the camera's shutter speed range, and the image will be either under or over-exposed. Change the aperture value until the blinking stops.

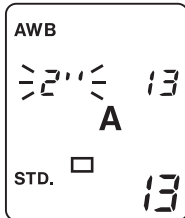

- With photography in the A mode, image quality may be degraded at shutter speeds slower than 1/2 second.
- To end photography in the A mode, repeat the operation described on the previous page to display P on the data panel, or press the Program-reset button.
- Changing the aperture value does not change the value in the viewfinder, however the effects of the change are reflected on the CCD and in the saved images.
- See page 81 for use of the flash in the A mode.

## S MODE – SHUTTER PRIORITY

In S mode, you select the shutter speed and the camera automatically sets the aperture required for proper exposure. This mode is useful when you want to control subject blur.

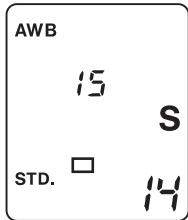
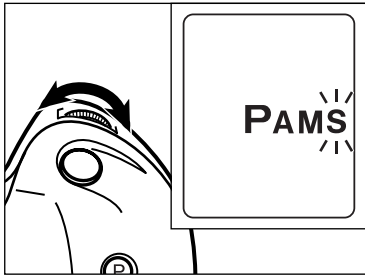
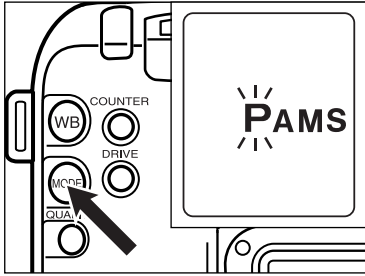

**1** In REC or , press and hold the **MODE** button.

- PAMS will appear in the data panel.
- The currently set exposure mode blinks on the data panel.

**2** Turn the front dial until **S** blinks in the data panel, then remove your finger from the **MODE** button.

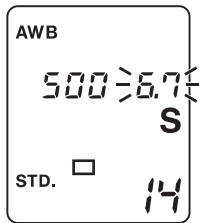
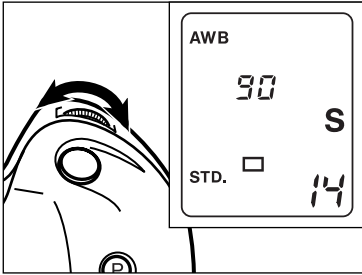

### 3 Turn the front dial to select the shutter speed.

- The shutter speed range is 1/2000~2 seconds.
- If the aperture display in the data panel blinks, the required setting is outside the aperture range of the lens. Turn the control dial until the blinking stops.
- If the aperture value blinks the required setting is beyond the camera's shutter speed range, and the image will be either under or over-exposed. Change the shutter speed until the aperture value stops blinking.
- Numbers such as 90 and 500 on the data panel indicate shutter speeds of 1/90th of a second, or 1/500th of a second respectively. Numbers such as 0.7 or 2 indicate 0.7 seconds and 2 seconds respectively.

- With photography in the S mode, image quality may be degraded at shutter speeds slower than 1/2 second.
- To end photography in the S mode, repeat the operation described on the previous page to display P on the data panel, or press the Program-reset button.
- See page 81 for use of the flash in the S mode.

## M MODE – MANUAL OPERATION

In M mode, you have full control of the exposure. You select both the shutter speed and the aperture. The viewfinder data panel will tell you if the exposure you have selected is over, under, or the same as the metered exposure.

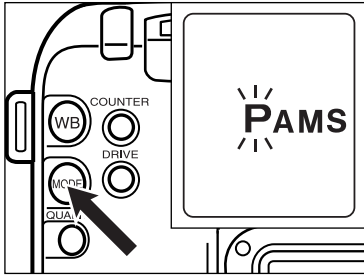

**1** In REC or , press and hold the **MODE** button.

- PAMS will appear in the data panel.
- The currently set exposure mode blinks on the data panel.

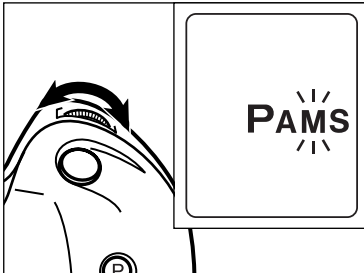

**2** Turn the front dial until M blinks in the data panel, then remove your finger from the **MODE** button.

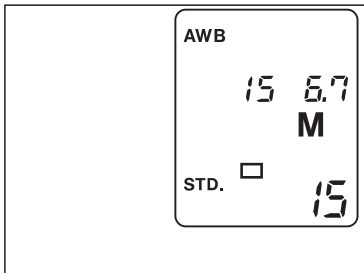

**3** Turn the front dial to select the **shutter speed**.

- The shutter speed range is 1/2000~30 seconds.

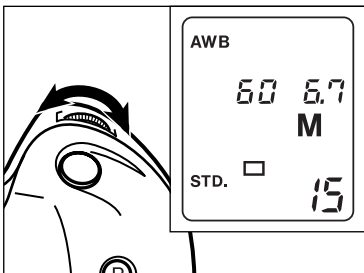



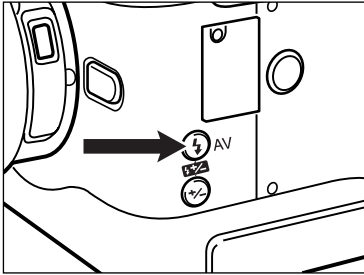

**4** While pressing the manual fill-flash button, turn the front dial to select the aperture.

- While the aperture range differs with the lens selected, the maximum aperture is F6.7, and minimum aperture is F22.

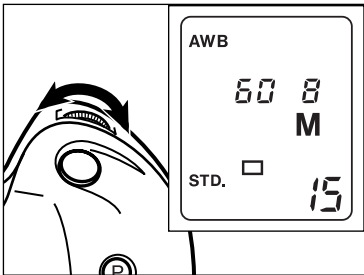

## Metering in Manual Mode

In the manual mode, the meter index will show you how the exposure you have set compares with the camera's meter reading. The + indicator tells you when your exposure is over, the – indicator tells you when your exposure is under. If neither indicator appears, the camera's meter reading agrees with the exposure you have set. Press the shutter-release button partway down to activate the meter.



Optimum exposure



The image will be over-exposed



The image will be under-exposed

- With photography in the M mode, image quality may be degraded at shutter speeds slower than 2 seconds.
- To end photography in the M mode, repeat the operation described on the previous page to display P on the data panel, or press the Program-reset button.
- See page 81 for use of the flash in the M mode.

## WHITE BALANCE

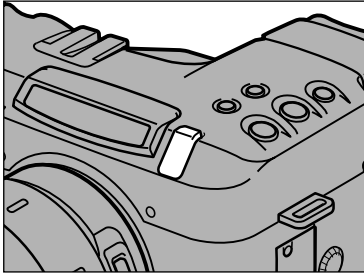





White Balance sensor

White Balance is the camera's ability to make different types of lighting appear neutral. The camera's Auto White Balance setting is appropriate for most situations.

However, manual white balance is necessary when the light source illuminating the white balance sensor is different than the light source illuminating the subject.

- For example, if the camera is in a room lit by a household lamp and the subject is outside lit by direct sunlight, then manually set the white balance to daylight mode.
- Auto White Balance may not work properly when the sensor is lit by morning or evening sunlight. Manually set the white balance to daylight mode.

This camera has five white balance modes:

ICON	MODE	EXPLANATION
<b>AWB</b>	Auto White Balance	The Auto setting will detect the type of light and adjust the white balance accordingly.
	Daylight	For outdoor/sunlight illuminated subjects.
	Tungsten	For incandescent lighting, such as the filament light bulbs in household lamps.
	Flash	Select this setting when using a non-dedicated attached accessory flash or PC mounted flash. Auto White Balance should be used for dedicated flash units.
	Custom	Create a white balance setting for a special lighting situation.

## ADDITIONAL FEATURES

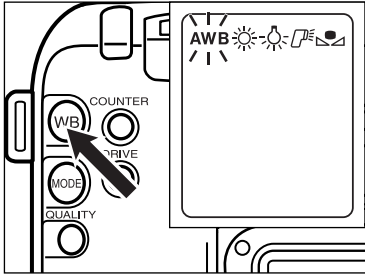

- 1 In REC or  mode, press and hold the WB (White-Balance) button.

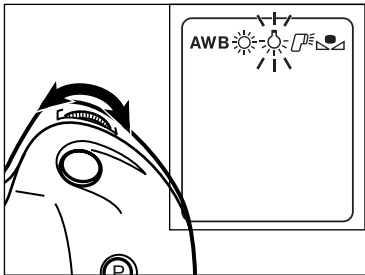

- 2 Turn the front dial until the icon for desired setting blinks, then remove your finger from the WB button.
  - The white-balance mode icon will appear in the data panel.

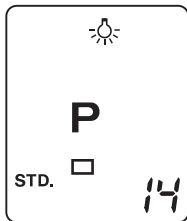



- The white-balance selection remains until another white-balance mode is selected or the program button is pressed. Turning the camera off does not reset the white balance selection.

## ADDITIONAL FEATURES

### CUSTOM WHITE BALANCE – CREATING A SETTING

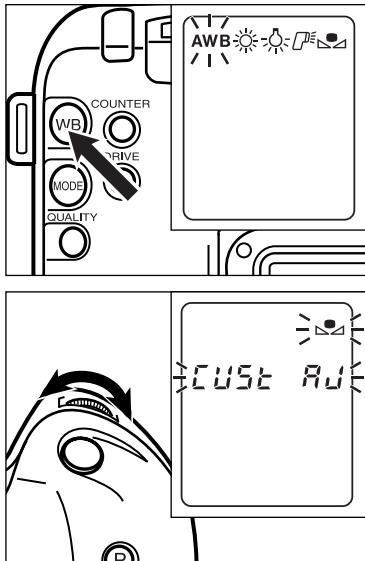
Create a custom white balance setting that can be selected again and again or changed at any time.



- 1** In REC or  mode, press and hold the WB button.
- 2** Turn the front dial until  and *CUST AW* blink in the data panel, then remove your finger from the WB button.
- 3** Focus on a white piece of paper large enough to fill the viewfinder frame.

## ADDITIONAL FEATURES

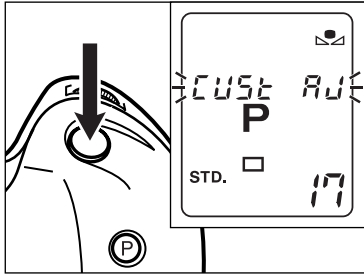

### 4 Press the shutter-release button all-the-way down.

- The shutter will release, but the camera does not record an image. *CUST AW* will appear briefly in the data panel and viewfinder.

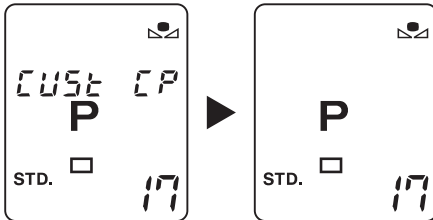

*CUST CP* will appear on the data panel, and in the viewfinder, if the white balance custom setting is satisfactory, and then return to the normal photography display.

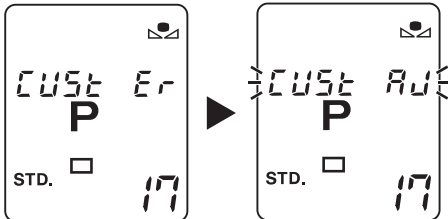

When the white balance cannot be set correctly, for example when the selected setting is outside the custom setting range for the camera, *CUST Er* will appear on the data panel, and in the viewfinder, and the system will then return to the condition prior to [4].

Reset to a new custom setting, or exit white balance setup by turning the dial while pressing the WB button.

- The display will change from *CUST AW* to *CUST CP* or *CUST Er* within 2 or 3 seconds. Do not make any other selections during this time.
- Custom setting is also possible for flash lighting.
- The correct white balance may not be obtainable with custom settings for subjects under bright florescent lighting.

## ADDITIONAL FEATURES

### CONTINUOUS DRIVE MODE

In this mode, the camera continuously takes pictures as fast as 1.5 frames per second. Up to five frames can be captured with one press of the shutter-release button.

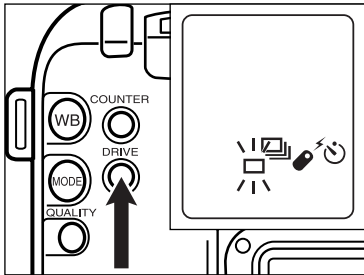

- 1 Press and hold the DRIVE (drive-mode) button.**

- The drive-mode icons will appear in the data panel.

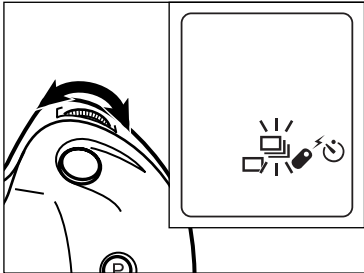

- 2 Turn the front dial until  blinks.**

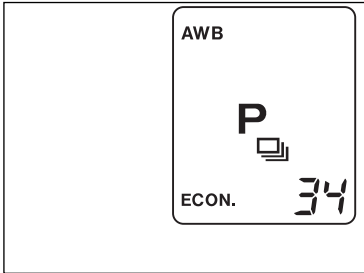

- 3 Release the DRIVE button.**

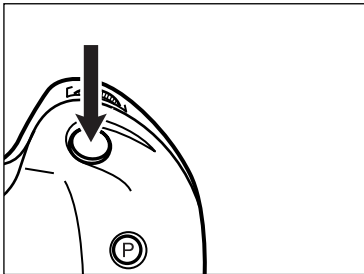



- 4 Press and hold the shutter-release button.**

- Up to five pictures may be taken while holding down the shutter-release button.



## ADDITIONAL FEATURES

The camera has a 5-frame internal image memory in which images are temporarily saved until being transferred to the compact flash card in the order in which they were taken.

The  icon is lit in the viewfinder when this image memory is full to indicate that no more pictures may be taken. When images in the image memory are transferred to the compact flash card and space becomes available, the  icon is extinguished and more pictures may then be taken.



More pictures may be taken when the  icon is extinguished.

Note that since the  icon is extinguished when enough space becomes available for one frame in the image memory, even though the  icon is extinguished, it may not be possible to take five pictures in quick succession.

During continuous photography the speed at which images are saved from the image memory to the compact flash card may result in a delay between shutter operation and recording of the image taken.

Note that the number blinking in the frame counter is the number of the frame currently being saved to the compact flash card, not the number of the frame currently being taken.

When the COUNTER button is pressed while images are being saved to the compact flash card, the number of images remaining in the image memory is shown in the shutter speed section of the data panel.

## ADDITIONAL FEATURES

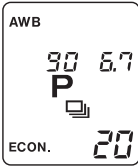

For example, if four successive frames are taken beginning from the status shown at left, the display will change as shown below.

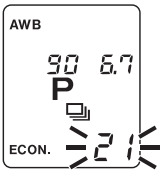

The 21st frame is being saved...

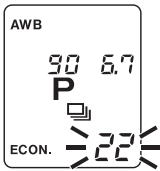

The 22nd frame is being saved...

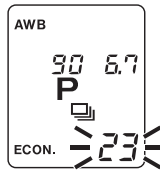

The 23rd frame is being saved...

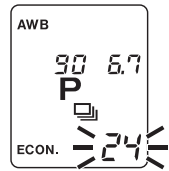

The 24th frame is being saved...





The 24th frame is saved.

When the COUNTER button is pressed the number of frames yet to be saved to the compact flash card from the image memory is shown in the shutter speed section of the data panel.



## ADDITIONAL FEATURES

- Pictures cannot be taken continuously while  appears on the data panel.
- Either select the frame photography icon  with [1] to [3] on page 66, or press the Program-reset button, to clear continuous photography.
- When using the flash, pictures may be taken without waiting for the flash to finish charging.
- The focus is automatically adjusted (however the shutter is not released until the focus has been adjusted) if the distance to the subject changes while holding down the shutter button.

## ADDITIONAL FEATURES

### SELF-TIMER

The self-timer will delay the release of the shutter for approximately 10 seconds after you press the shutter-release button.

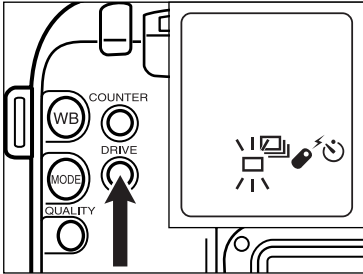

- 1 Place the camera on a tripod, then press and hold the DRIVE (drive-mode) button.**
  - The drive-mode icons will appear in the data panel.

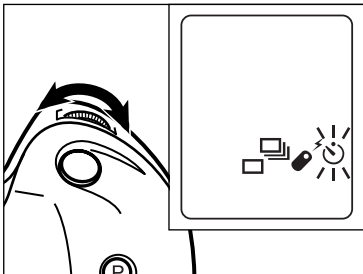

- 2 Turn the front dial until  blinks.**

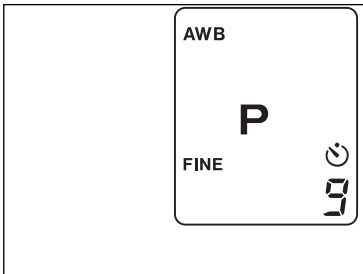

- 3 Release the DRIVE button.**

- 4 Arrange the camera and subject positions, and compose your picture.**

## ADDITIONAL FEATURES

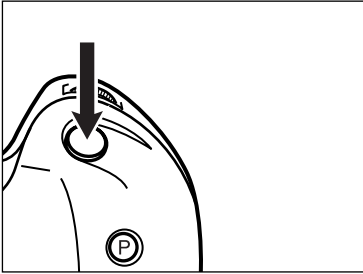

- 5 Press the shutter-release button all-the-way down to start the timer. The self-timer lamp on the front of the camera will blink, then glow just before the shutter releases.**

- The self-timer mode will automatically cancel after the exposure is made.
- Do not press the shutter-release button while standing in front of the camera.
- If you want to take a picture with your subject outside of the focus frame, use focus hold. See page 44.
- To stop the countdown, press the DRIVE button while turning the Front dial once. To cancel the self-timer before the shutter releases, turn the main switch to switch the camera off or press the program-reset button.

### ATTACHING THE EYEPiece CAP

Attach the eyepiece cap if there is a bright light source behind the camera. The eyepiece cap prevents exposure problems caused by stray light from entering the eyepiece.

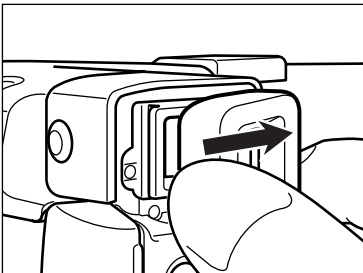

- 1 Remove the eyepiece cup.**

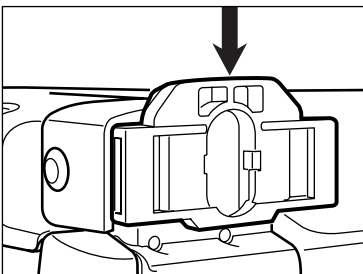

- 2 Slide the eyepiece cap on.**

## ADDITIONAL FEATURES

### REMOTE CONTROL (SOLD SEPARATELY)

The IR Remote Control RC-3 allows remote camera operation up to 5m away.

- The remote control may not operate with backlit subjects or under fluorescent light.
- Remote control is not cleared after a photograph is taken, and photography can therefore be continued.
- To save power, remote-control mode is canceled if the remote control is not operated for more than 8 minutes.

### REMOTE CONTROL MODE

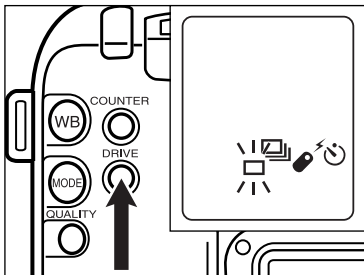

- 1 Place the camera on a tripod, then press and hold the DRIVE (drive-mode) button.**

- The drive-mode icons will appear in the data panel.

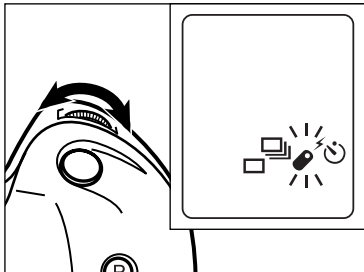

- 2 Turn the front dial until  blinks.**

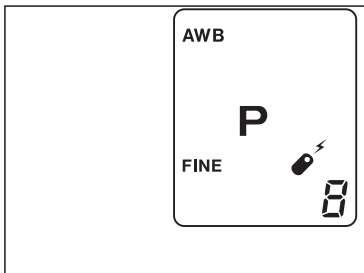

- 3 Release the DRIVE button.**

## ADDITIONAL FEATURES

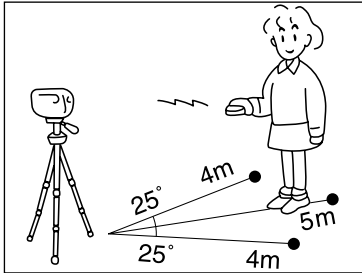

- 4** Arrange the camera and subject positions, and compose your picture.

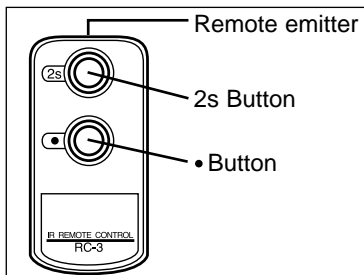

- 5** Point the remote emitter toward the front of the camera and press the • or 2s button.

- If the • button is pressed, the lamp on the front of the camera will blink once and take the picture.
- If the 2s button is pressed, the lamp on the front of the camera will blink for two seconds before the picture is taken.
- To cancel, reset the drive-mode, press the program-reset button, or turn the camera off.

## ADDITIONAL FEATURES

### FOCUS HOLD IN REMOTE CONTROL MODE

When your subject is not centered in the focus frame, use manual focus or focus hold.

- 1 Set the camera to the remote-control mode.

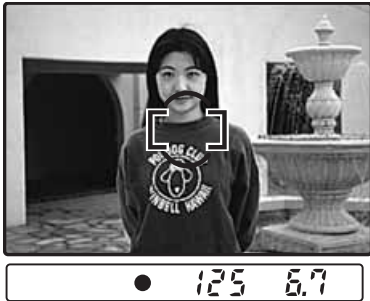

- 2 Center your subject in the focus frame, then press the shutter-release button partway down.

- 3 Release the shutter button when the focus signal ● in the viewfinder is lit (i.e. focus has been adjusted).

- The focus icon is extinguished when the shutter button is released, however the focus remains set.

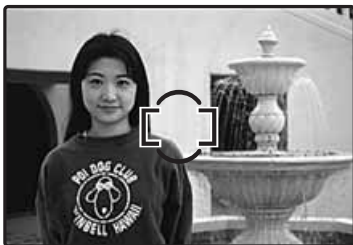

- 4 Recompose the picture.

- 5 Point the remote toward the front of the camera and press the ● or 2s button.

- The focus remains set after photography is complete. It is cleared by any operation of the camera (eg pressing a button).
- Photography is also possible using manual focusing.

### CHANGING THE REMOTE CONTROL BATTERY

The remote control uses a 3V lithium battery (CR2032). When pressing the remote-control buttons does not release the shutter, the battery must be replaced. A new battery should be sufficient for around ten years of operation.

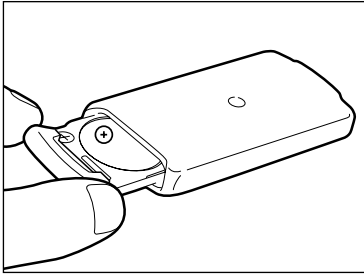

- 1** Pull out the battery chamber and remove the old battery.

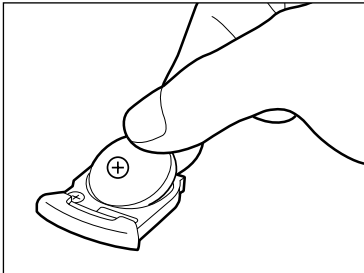

- 2** Insert a new battery into the battery chamber with its plus side up.

- 3** Slide the battery chamber back into the remote control.

 **WARNING**

**KEEP BATTERIES THAT COULD BE SWALLOWED AWAY FROM YOUNG CHILDREN. CONTACT A DOCTOR IMMEDIATELY IF A BATTERY IS SWALLOWED.**

## ADDITIONAL FEATURES

### PROGRAM-RESET BUTTON

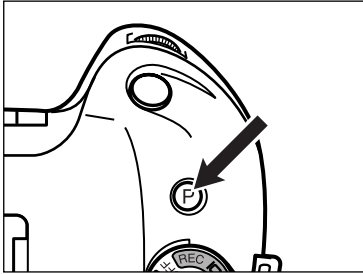

Pressing the Program-reset button is a quick way to return the camera to fully automatic operation.

FUNCTION	P MODE SETTING	PAGE
Exposure Mode	P (Programmed Autoexposure)	51
Focus Mode	Auto Focus Mode	42
White Balance	AWB (Auto White Balance)	58
Drive-mode	Single-frame Advance	—
Self-timer	Cleared (both before and during)	66
Exposure Compensation	0.0	47
Flash Compensation	0.0	84

The following settings are unaffected by pressing the Program-reset button.

- Image quality
- ISO sensitivity



## ADDITIONAL FEATURES

### COUNTER BUTTON

This display allows the user to determine the space remaining in the compact flash card as a guide to the number of frames which may be saved.

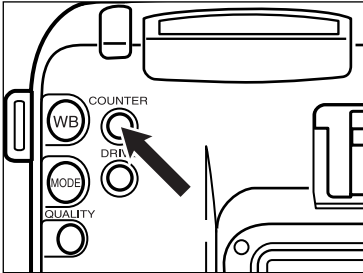

**1 Press and hold the COUNTER button.**

- The following is displayed on the data panel.
- Release the COUNTER button to return to normal display.

**When not saving to the compact flash card.**



Space remaining in the compact flash card (approximately 7MB in the example at left).

Number of frames in the image memory yet to be saved to the compact flash card (three frames in the example at right).

Approximate number of remaining frames which may be taken in the currently selected mode (standard mode in the example at left).

Currently selected image quality mode (the standard mode in the example above).

**When saving to the compact flash card.**

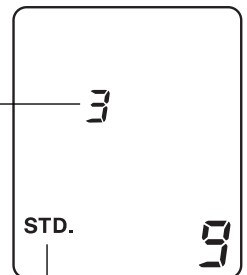

- The displayed value for the remaining number of frames which may be saved is only a guide. The actual number will depend on the scenes photographed.
- The remaining number of frames which may be saved changes with image quality. This number may change dramatically when the super-fine or fine mode is selected. Before using the camera, press the COUNTER button to check the remaining number of frames which may be saved.

## ADDITIONAL FEATURES

### CHANGING ISO SENSITIVITY

The CCD used in this camera has a sensitivity of ISO200 when shipped from the factory. It may be set to ISO800 if required.

This will improve camera performance by letting you use it in dark, indoor locations with high shutter speeds, thus eliminating camera shake, and in the A mode (aperture priority) with smaller apertures, thus ensuring a wider depth of field.

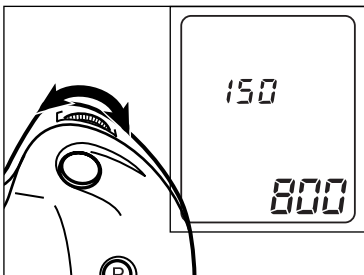
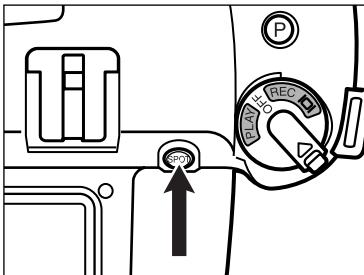
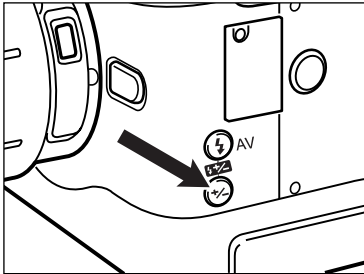

**1 Press and hold the exposure compensation button, then press the SPOT button.**

- The current ISO sensitivity will appear on the data panel.
- Continue pressing both the exposure compensation and SPOT buttons until setting is complete.

**2 With both buttons held down, turn the dial to display '800' in the frame counter.**

- The value in the frame counter alternates between 200 and 800 with each click of the dial.

### **3 Release both the exposure compensation and SPOT buttons.**

- The ISO sensitivity selected in [2] is now set.
  - To return to the ISO200 value, display 200 in the frame counter in [2] and release both buttons.
- 
- Changing to ISO800 sensitivity does not change the CCD, but rather amplifies the video signal electronically. As is the case with a gain up in a video camera, the noise component of the signal is also amplified. The image therefore assumes a speckled appearance, and image quality is degraded in comparison to that when ISO200 is selected.

## ADDITIONAL FEATURES

### FORMATTING A COMPACT FLASH CARD

Formatting a Compact Flash card removes all protected and unprotected images from the card.

The standard accessory cards are pre-formatted. Compact Flash cards purchased separately may need formatting.

**This deletes all write-protected images. Take extreme care when formatting.**

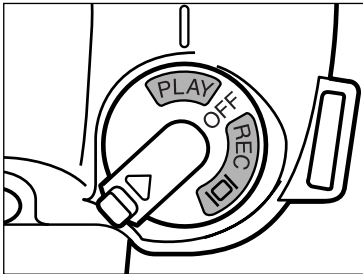

**1** Turn the Control dial to **PLAY**.

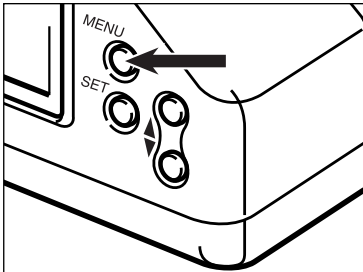

**2** Press the **MENU** button.

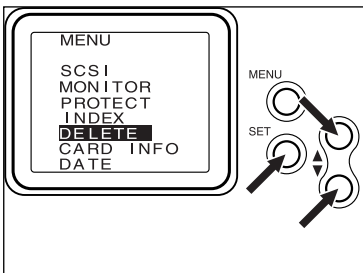

**3** Press the **▼** button until **DELETE** is highlighted, then press the **SET** button.

## ADDITIONAL FEATURES

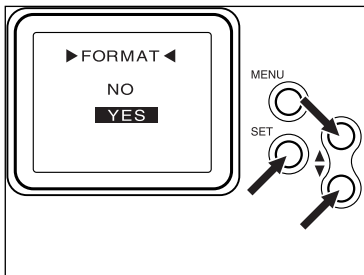
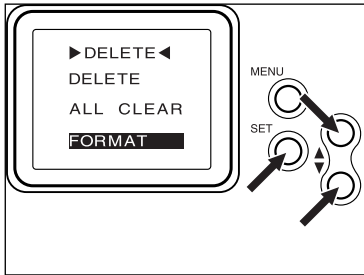

- 4** Press the ▼ button until **FORMAT** is highlighted, then press the **SET** button.

- A confirmation screen will appear.

- 5** Press the ▼ button until **YES** is highlighted, then press the **SET** button.

- The LCD monitor will return to the **PLAY** screen after the card is formatted.

## USING FLASH

Your camera has a Minolta standard accessory shoe for attaching dedicated flash units (Accessory Information p.114).

Flash units can also be attached to the camera using a sync cord via the PC terminal.

The accessory flash's AF illuminator will be activated when necessary.

### Accessory Flash Notes

- To use a 1000 series AF flash unit, the Flash Shoe Adapter FS-1100 must be attached to the camera. When the flash is on, the flash will fire each time the shutter is released. At no time will the flash's AF illuminator activate.
- The 5400HS, 5400xi, 3500xi, 3200i, and 5200i flashes zoom according to the focal length of the lens.
- For the 5400HS, 5400xi, and 5200i flashes, the flash range and coverage angle displays on the flash may not display focal lengths accurately.
- The flash range diagrams in the 3500xi and 3200i flash units are applicable for focal lengths with this camera.

## ATTACHING AN ACCESSORY FLASH

This camera has a Minolta standard accessory shoe.

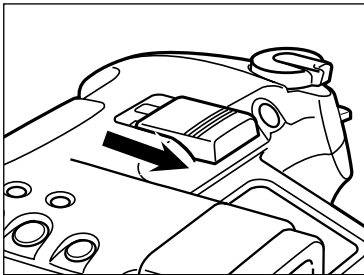

- 1 Remove the cap from the accessory shoe.

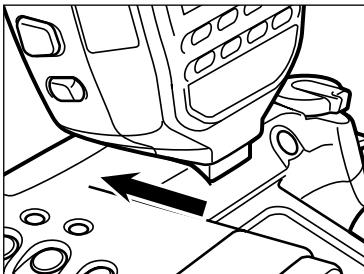





- 2 Align the flash's mounting shoe with the camera's accessory shoe, then slide the flash forward until it locks firmly in place.

# FLASH

## FLASH SIGNALS

When the shutter-release button is pressed partway down, the necessary flash signals will appear.

Flash-on indicator , Flash signals 

 LIT	FLASH CHARGING.
 AND  LIT	FLASH CHARGED.
 BLINKING (AFTER TAKING PHOTO)	FLASH OUTPUT WAS SUFFICIENT TO PROVIDE CORRECT EXPOSURE.

## PC TERMINAL

This camera is equipped with a PC connector which enables you to connect PC-capable flash units with a flash sync cord.

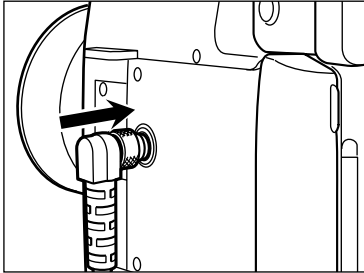

**Set the exposure mode to M, then set the shutter to 1/125 or slower.**

**Manually set white balance to the flash mode (see page 58).**

- Turn the flash unit off before connecting the sync cord to the PC terminal or the flash unit may fire unexpectedly while connecting.
- Your camera's PC terminal is compatible with both center-positive and center-negative flash units.
- Flash units with an extremely low trigger voltage may not work with the camera. If your flash has a low trigger voltage, contact a Minolta Service Facility.



## USING FLASH IN P, A, S, AND M MODES

### P Mode Flash

When a programmable flash is attached and power is ON it will fire automatically when flash becomes necessary. Shutter speed and aperture value are determined automatically.

The Flash-on indicator  $\square^{FE}$  is lit in the viewfinder when the flash is fired. The flash will not fire when the Flash-on indicator  $\square^{FE}$  is extinguished, or when the flash power supply is OFF.

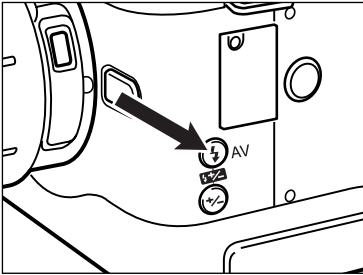

If the flash is to be used with each picture, press the shutter button while holding down the manual fill-flash button.

### A Mode Flash

When an attached accessory flash is on, it will fire each time a picture is taken. The attached accessory flash will not fire when OFF. The camera will automatically set the shutter to 1/125 (the flash sync speed). Refer to the accessory flash manual to determine the aperture and the flash range. While the aperture range differs with the lens selected, the maximum aperture is F6.7, and minimum aperture is F22.

### S Mode Flash

When an attached accessory flash is ON, it will fire each time you take a picture. The attached accessory flash will not fire when OFF.

- Flash operation in the S mode is the same as P mode. The camera automatically sets the aperture and the shutter speed.

### M Mode Flash

When an attached accessory flash is on, it will fire each time you take a picture. The attached accessory flash will not fire when OFF.

- Refer to the accessory flash manual to determine the aperture setting and the flash range.
- In manual mode, you select both the aperture and the shutter speed for each exposure. While the aperture range differs with the lens selected, the maximum aperture is F6.7, and minimum aperture is F22.
- The shutter speed can not be set faster than 1/125th of a second when using flash.

## SLOW-SHUTTER SYNC

In P and A modes, slow-shutter sync sets a slower shutter speed to increase the background or ambient lighting exposure in a flash picture. Flash output will automatically be decreased to maintain a correct exposure of your subject.



With Slow-Shutter Sync



Without Slow-Shutter Sync

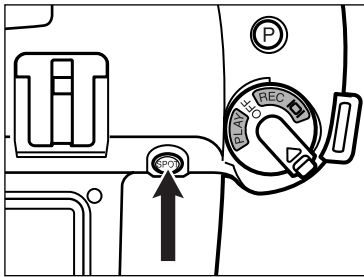

**1** Frame your subject.

**2** While pressing the **SPOT** button, press the shutter-release button all-the-way down to take the picture.



## FLASH

- If the background is bright or a small aperture is set (in A mode), the shutter speed may not be reduced.
- Use a tripod if the shutter speed becomes too slow to allow sharp, hand-held pictures after you press the SPOT button.

## FLASH COMPENSATION

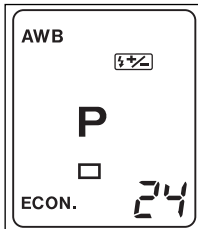
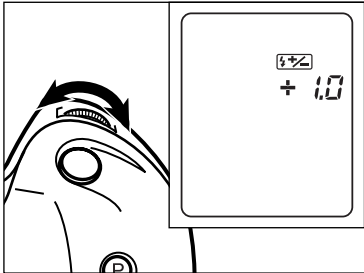
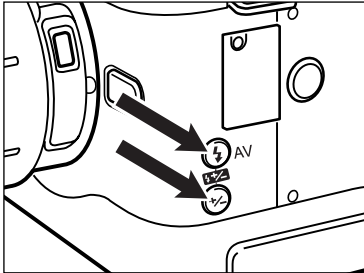
This function enables you to bias the output of an accessory flash as much as + or – 3 EVs in 0.5 EV increments.



- 1 Press and hold the Exposure-compensation button and the manual fill-flash button.
- 2 Turn the Front dial until the desired compensation factor appears in the data panel and viewfinder, then release the buttons.
- 3
  -  will remain in the data panel.
  -  will remain in the viewfinder.
  - Flash compensation does not operate with flash units connected to the PC terminal.

- Check the compensation amount by pressing the flash-compensation and exposure-compensation buttons.
- Cancel flash compensation by resetting it to 0.0 or pressing the Program-reset button.
- Use exposure compensation when the exposure level for the overall image is to be compensated for both flash and normal illumination (see page 47). If flash compensation is also set in this case the light from the flash will be subject to dual compensation. The desired result will not be obtained if the sum of the exposure compensation and flash compensation values is less than -3.0 or greater than +3.0.

## WIRELESS/REMOTE OFF-CAMERA FLASH

The separately available 5400HS or 5400xi programm flash units are necessary for Wireless/Remote off-camera flash photography.



Photo 1  
Normal Flash

A flat, lifeless photograph may result when the flash is attached to the camera. In such cases, remove the flash from the camera and reposition it to provide shadows to provide a three-dimensional feel to the photograph (see Photo 2).

Photo 3 was taken using two programm flash units distant from the camera and providing flash illumination in a ratio of 2:1. This has resulted in gentle transitions from light to dark, with natural shadows.



Photo 2  
Wireless/Remote Flash

The camera and flash must normally be connected by cable in such cases. This camera permits transmission of signals to flash units using light from the flash rather than cables. The camera automatically determines the optimum exposure.



Photo 3  
Wireless/Remote Ratio Flash

Wireless/Remote off-camera flash is used as follows:

**1 Wireless/Remote off-camera flash photography with a program flash unit attached to the camera, and the camera supplying the flash signal.**

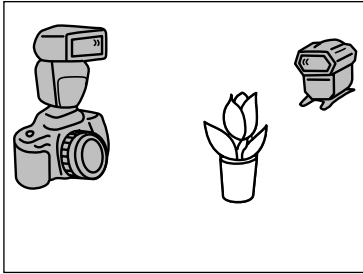

This illustration shows a single-lens reflex camera. The digital camera is used in exactly the same way.

The 5400HS or 5400xi programm flash units must be attached to the camera for Wireless/Remote off-camera flash photography (ie two program flash units are required).

See the 5400HS or 5400xi manual for details.

- The 5400xi manual shows the Dynax 9xi body, however it may also be used with this camera. The AE-lock button is used for test illumination with the Dynax 9xi, however the SPOT button is used for this purpose with this camera.

**2 Wireless/Remote off-camera flash photography with the Wireless Remote Flash Controller (separately available) supplying the flash signal.**

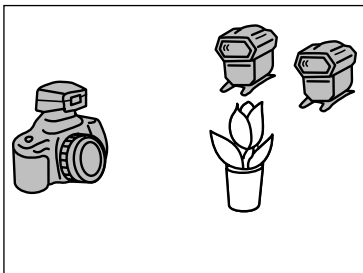

This illustration shows a single-lens reflex camera. The digital camera is used in exactly the same way.

The Wireless Remote Flash Controller may be attached to the camera in place of the built-in flash for Wireless/Remote off-camera flash photography. Using the Wireless Remote Flash Controller allows illumination with two or more distant programm flash units, and proportional illumination control of each.

See the Wireless Remote Flash Controller manual for details.

- The Wireless Remote Flash Controller is sold as a Dynax 9xi accessory, however it may also be attached to this camera. The AE-lock button is used for test illumination with the Dynax 9xi, however the SPOT button is used for this purpose with this camera.

**PLAY**

## VIEWING IMAGES

The captured images are displayed in the LCD monitor in Play mode. It is possible to view the images full-screen or view them in index form.

### VIEWING FULL SCREEN

View one full-frame image at a time.

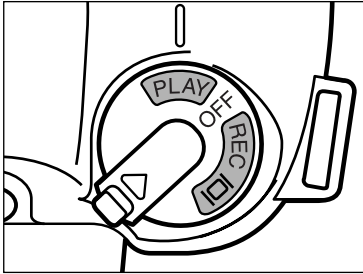

- 1 With the Control dial lock button pushed in the  $\triangle$  direction, turn the Control dial to the right to the PLAY position.**

- After a short wait the last image recorded is displayed on the LCD monitor.

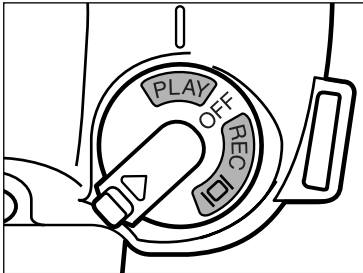

- 2 Press the  $\blacktriangle$  and  $\blacktriangledown$  buttons to scroll through the images.**

- The  $\blacktriangle$  button scrolls forward, the  $\blacktriangledown$  button scrolls backward.
- The image appears on the LCD monitor, it will be rough while the camera is reading from memory, then a clear image will appear.

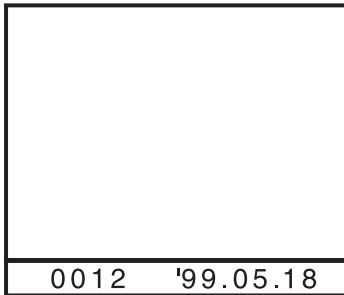
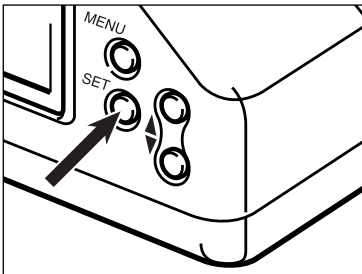
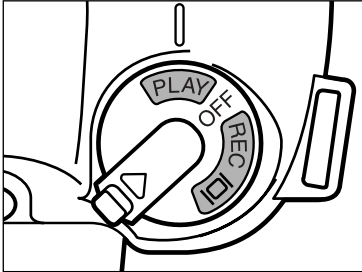

Image frame No.      Image record date



## VIEWING AN IMAGE INDEX

This function displays four or nine frames on the LCD monitor simultaneously, and is therefore a convenient way to find the desired image.



- 1 With the Control dial lock button pushed in the  $\triangle$  direction, turn the Control dial to the right to the PLAY position.**

- After a short wait the last image recorded is displayed on the LCD monitor.

- 2 Press the SET button on the back of the camera.**

- The LCD monitor changes from single-frame play to index play. The monitor is divided into a four or nine-image index depending upon which was selected during previous index play.
- The red border appears around the image displayed before the SET button was pressed.
- When changing from single-frame play to index play, in addition to the image displayed before the SET button was pressed, three or eight images are transferred to the image memory one-by-one. A short wait is required before they are displayed. Once the images are in the image memory they may be selected immediately.

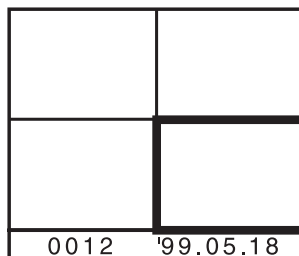
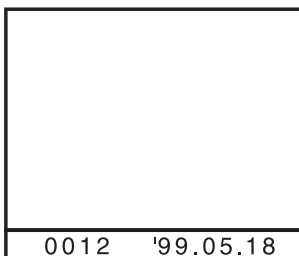

## VIEWING IMAGES

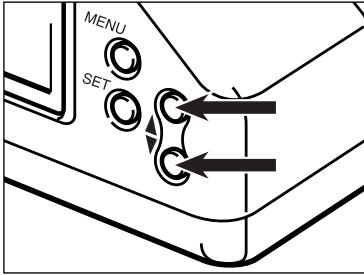

**3** Use the ▲ or ▼ button on the back of the camera to move the border to the image to be viewed.

- Pressing the ▲ button moves the border to the previous image. Pressing the ▼ button moves the border to the next image.
  - The image will appear coarse immediately after it is selected, however it will gradually become clear as it is read from the memory.
- 
- When the border is on the image at bottom-right, pressing the ▼ button displays the next four or nine frames.
  - When the border is on the image at top-left, pressing the ▲ button displays the previous four or nine frames.
  - When the next or previous four or nine frames are not already in the image memory they are read into it one-by-one. A short wait is required before they are displayed.
  - The diagram below includes frame numbers for the purposes of clarity in explaining the changes on the LCD monitor. These numbers do not appear during index play.

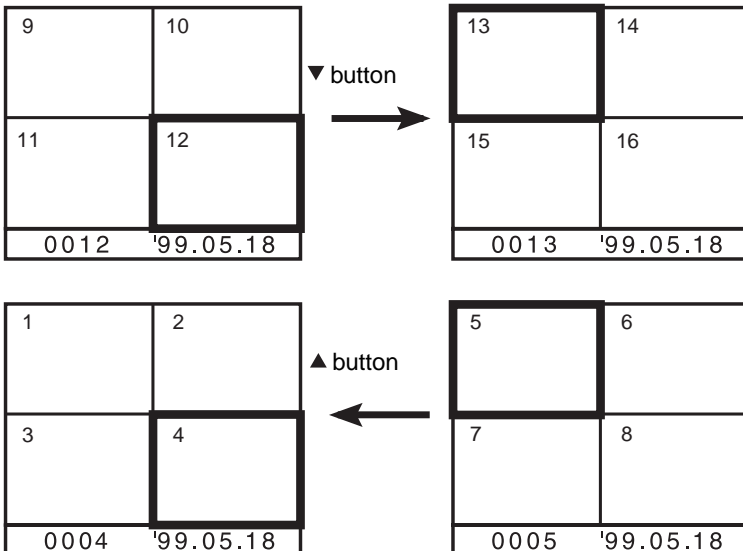

## VIEWING IMAGES

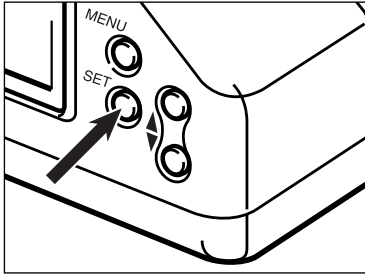

### 4 Press the SET button on the back of the camera.

- The LCD monitor changes from index play to single-frame play.
- The image enclosed in the red border appears on the LCD monitor.
- The diagrams below, and on the next page, include frame numbers for the purposes of clarity in explaining index play. These numbers do not appear during index play.

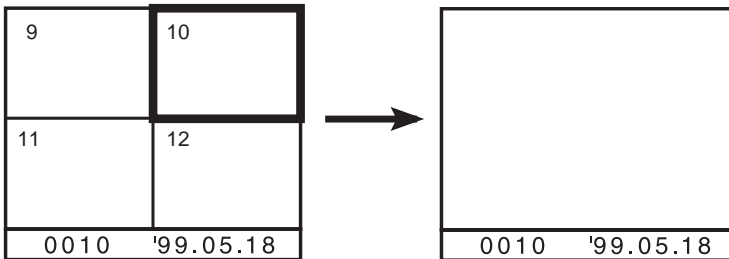

## VIEWING IMAGES

Index play displays pages of four or nine frames.

If, as shown in the example below, the nine-frame index play is selected when the seventh frame is displayed, the nine-frame page containing the seventh frame is displayed.

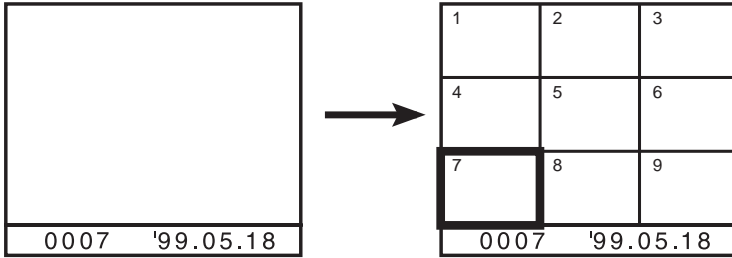

The LCD monitor is blank if there is no image data.

If, for example, only 25 frames have been saved in the compact flash card, the 26th and later frames will be displayed as black on the LCD monitor.

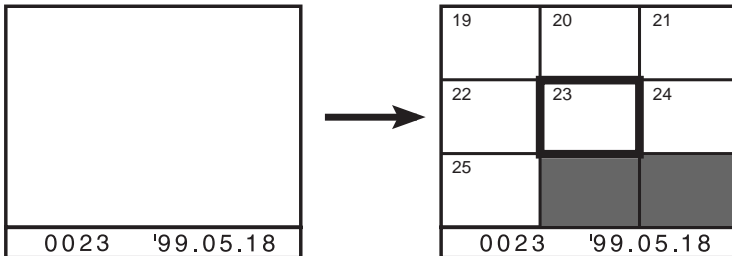

## CHANGING THE INDEX DISPLAY

Set the index display to a 4-image index or 9-image index.

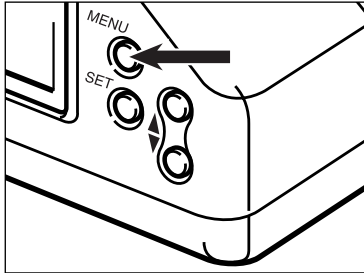

- 1 Press the MENU button on the back of the camera.**

- The top menu will appear.

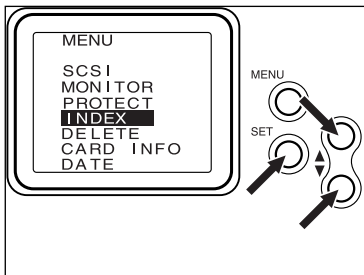

- 2 Press the ▲ or ▼ button as required to move the highlight to INDEX, and then press the SET button.**

- The INDEX menu will appear.

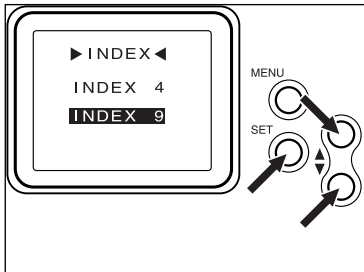

- 3 Press the ▲ or ▼ button as required to move the highlight to INDEX 4 (four-image index) or INDEX 9 (nine-image index), and then press the SET button.**

- Index play uses the selected setting. Press the SET button again to select single-frame play.

## DELETING A SINGLE IMAGE

Delete a single, unprotected image from the compact flash card in the camera.

As a deleted image cannot be recovered, care is required when deleting images. Important images can be write-protected to prevent accidental deletion (see page 98).

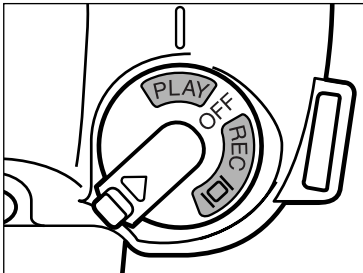

**1** Turn the Control dial to **PLAY**.

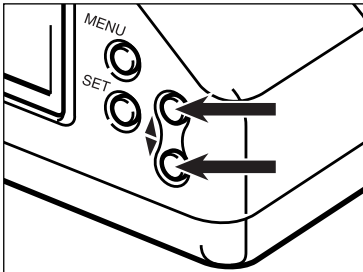

**2** Select the desired image.

- Press the ▲ or ▼ button until the image appears in the LCD monitor. In Index display, press the ▲ or ▼ button until a border appears around the desired image.

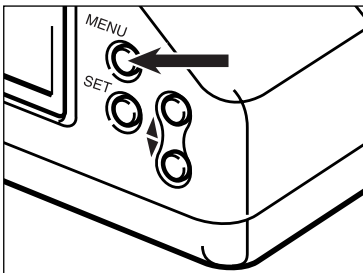

**3** Press the **MENU** button.

## DELETING A SINGLE IMAGE

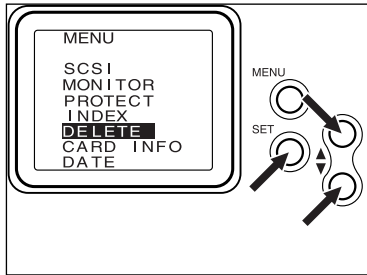

- 4** Press the ▼ button until **DELETE** is highlighted, then press the **SET** button.

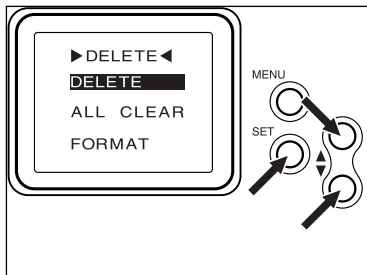

- 5** Press the ▼ button until **DELETE** is highlighted, then press the **SET** button.
- A confirmation screen will appear.

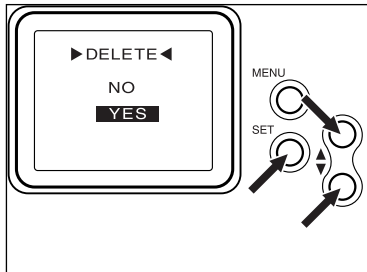

- 6** Press the ▼ button until **YES** is highlighted, then press the **SET** button.
- The LCD monitor will return to the **PLAY** screen after the image is deleted.
- 7** Repeat [2] to [6] if you have other images to be deleted.

## CLEARING UNPROTECTED IMAGES

Clearing removes all unprotected images from the compact flash card in the camera.

**AS A DELETED IMAGE CANNOT BE RECOVERED, CARE IS REQUIRED WHEN DELETING IMAGES.**

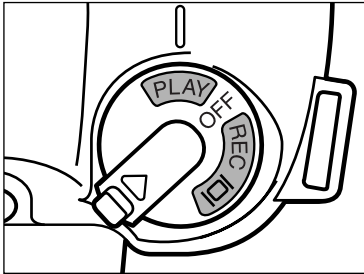

**1** Turn the Control dial to PLAY.

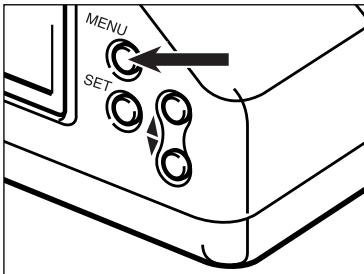

**2** Press the MENU button.

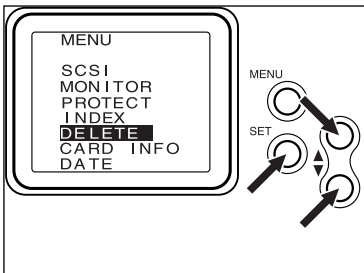

**3** Press the ▼ button until DELETE is highlighted, then press the SET button.



## CLEARING UNPROTECTED IMAGES

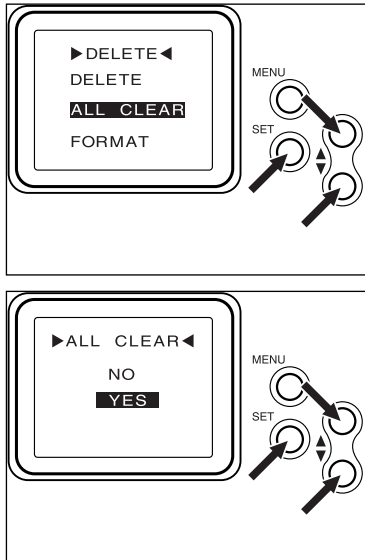

- 4** Press the ▼ button until **ALL CLEAR** is highlighted, then press the **SET** button.

- A confirmation screen will appear.

- 5** Press the ▼ button until **YES** is highlighted, then press the **SET** button.

- The LCD monitor will return to the **PLAY** screen after the image is deleted.

- Protected images will remain on the compact flash card after clearing.

## PROTECTING IMAGES

Important images can be write-protected to guard them from accidental deletion. Protected images cannot be removed from the CF card in the camera by Using the Delete or Clear All functions.

**PROTECTED IMAGES WILL BE REMOVED WHEN THE FORMAT FUNCTION IS USED.**

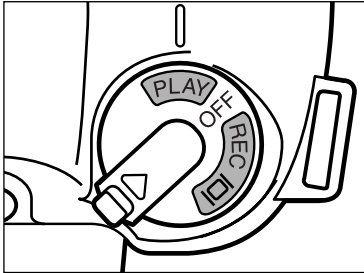

**1 Turn the Control dial to PLAY.**

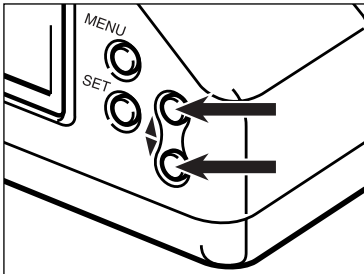

**2 Select the desired image.**

- Press the ▲ or ▼ button until the image appears in the LCD monitor. In Index display, press the ▲ and ▼ buttons until a border appears around the desired image.

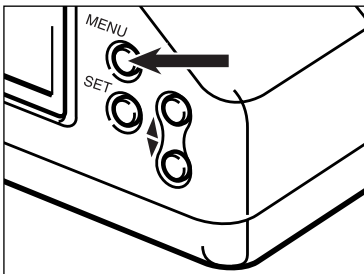

**3 Press the MENU button.**

## PROTECTING IMAGES

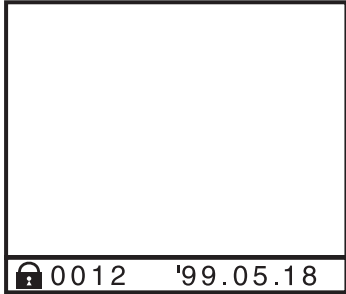
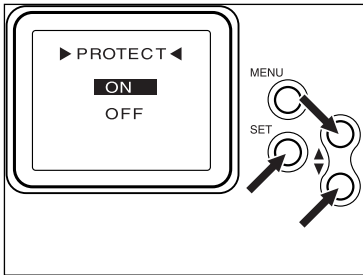
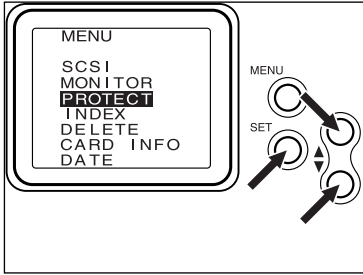

Protect icon

- 4 Press the ▼ button until **PROTECT** is highlighted, then press the **SET** button.

- The PROTECT menu will appear.

- 5 Press the ▼ button until **ON** is highlighted, then press the **SET** button.

- The camera will return to the Play screen and  will appear in the information bar when the image is selected.

- 6 Repeat steps [2] to [5] for any other images to be write-protected.

## UNPROTECTING IMAGES

- 1** Display the images for which write-protect is to be cleared with steps [1] to [2] on page 98.

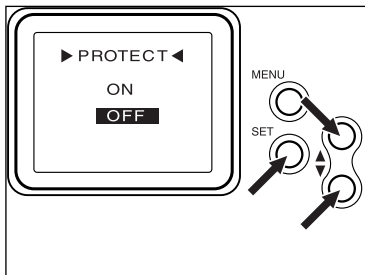

- 2** Select the Protect menu with steps [3] to [4] (see pages 98, 99), highlight OFF with step [5] , and press the SET button.
  - This clears write-protect for the displayed image.
  - The write-protect icon at the bottom left of the LCD monitor disappears.
- 3** Repeat [1] to [2] for any other images for which write-protect is to be cleared.

## PROTECTING IMAGES

When an attempt is made to delete a write-protected image, PROTECT appears on the LCD monitor as shown below to indicate that the image cannot be deleted.

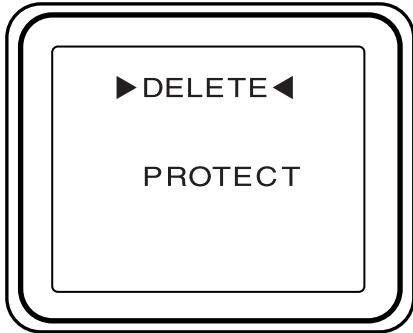

## ADJUSTING THE LCD MONITOR BRIGHTNESS/CONTRAST

The camera's LCD monitor brightness and contrast can be adjusted to compensate for varying lighting conditions and viewing angles.

- Changing the LCD brightness/contrast does not affect the brightness/contrast of recorded images.

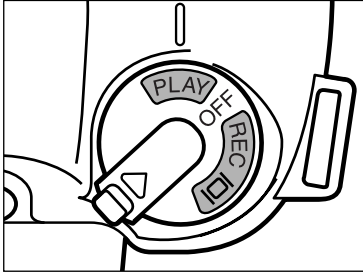

- 1** With the Control dial lock button pushed in the  $\triangle$  direction, turn the Control dial to the right to the PLAY position.

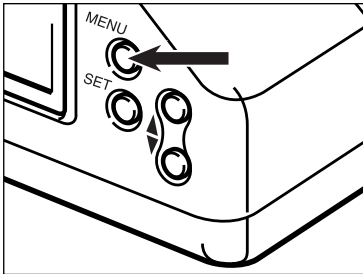

- 2** Press the MENU button on the back of the camera.
  - The top menu will appear.

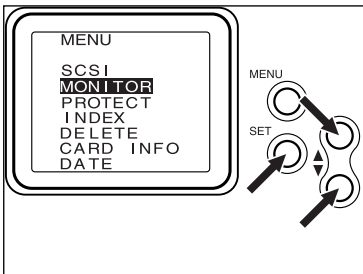

- 3** Press the  $\blacktriangle$  or  $\blacktriangledown$  button a number of times to highlight MONITOR, and press the SET button.
  - The LCD monitor BRIGHTNESS/CONTRAST menu will appear.

## ADJUSTING THE LCD MONITOR BRIGHTNESS/CONTRAST

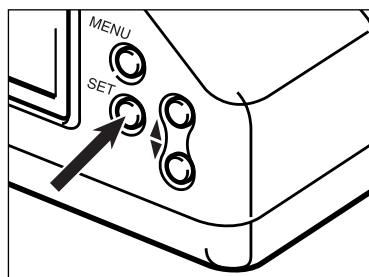
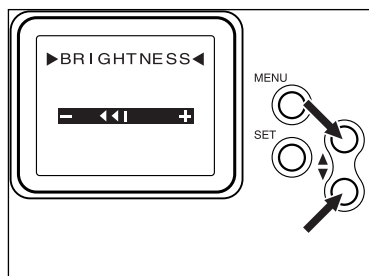
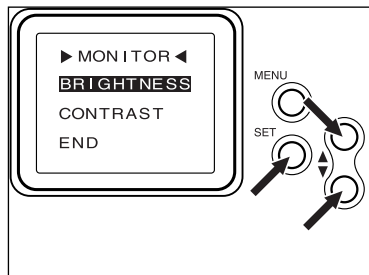

- 4 Press the ▲ or ▼ button to highlight **BRIGHTNESS** on the LCD monitor **BRIGHTNESS/CONTRAST** menu, and press the **SET** button.

- The **BRIGHTNESS** menu will appear.
- Skip this adjustment if brightness is satisfactory, and go directly to [7].

- 5 Press the ▲ or ▼ button to **adjust the brightness of the LCD monitor**.

- Pressing the ▲ button increases the brightness of the LCD monitor. Pressing it once increases by one the number of ▶ symbols in the right of the bar.
- Pressing the ▼ button decreases the brightness of the LCD monitor. Pressing it once increases by one the number of ◀ symbols in the left of the bar.
- Brightness may be adjusted up to four ▶ or ◀ symbols.

- 6 Press the **SET** button when the **desired brightness is reached**.

- The system returns to the LCD monitor **BRIGHTNESS/CONTRAST** menu.

## ADJUSTING THE LCD MONITOR BRIGHTNESS/CONTRAST

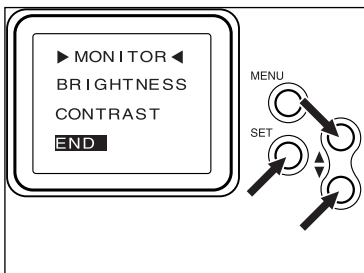
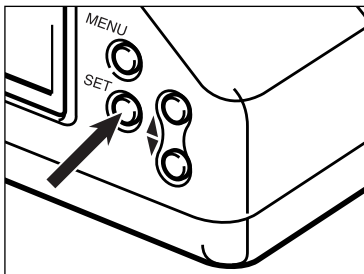
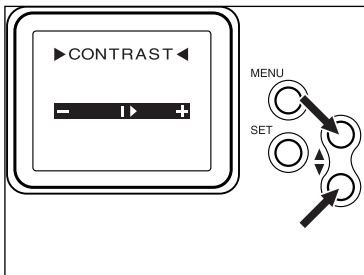
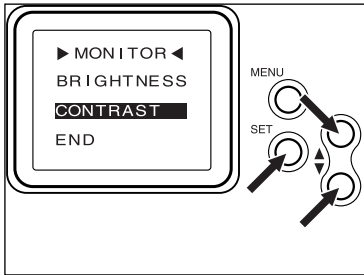

- 7** Press the ▲ or ▼ button a number of times to highlight CONTRAST, and press the SET button.
- The LCD monitor CONTRAST menu will appear.
  - Skip this adjustment if contrast is satisfactory, and go directly to [10].

- 8** Press the ▲ or ▼ button to adjust the contrast of the LCD monitor.
- Pressing the ▲ button increases the contrast of the LCD monitor. Pressing it once increases by one the number of ► symbols in the right of the bar.
  - Pressing the ▼ button decreases the contrast of the LCD monitor. Pressing it once increases by one the number of ◀ symbols in the left of the bar.
  - Contrast may be adjusted up to four ► or ◀ symbols.

- 9** Press the SET button when the desired contrast is reached.
- The system returns to the LCD monitor BRIGHTNESS/CONTRAST menu.

- 10** Press the ▲ or ▼ button to highlight END, and press the SET button.
- The LCD monitor returns to the menu on page 102.



## CHECKING FLASH CARD STATUS

A CF card information screen is available to give information about the amount of card memory used, the amount available, and estimates on the number of images that can fit in the remaining space.

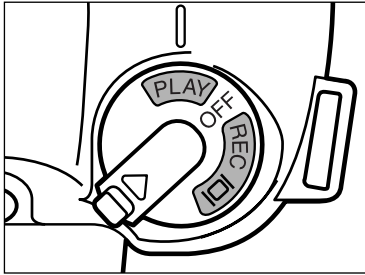

**1** Turn the Control dial to **PLAY**.

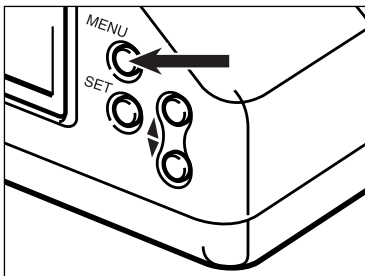

**2** Press the **MENU** button.

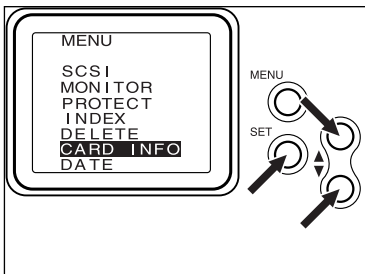

**3** Press the **▼** button until **CARD INFO** is highlighted, then press the **SET** button.

- The Card Info menu will appear.

## CHECKING FLASH CARD STATUS

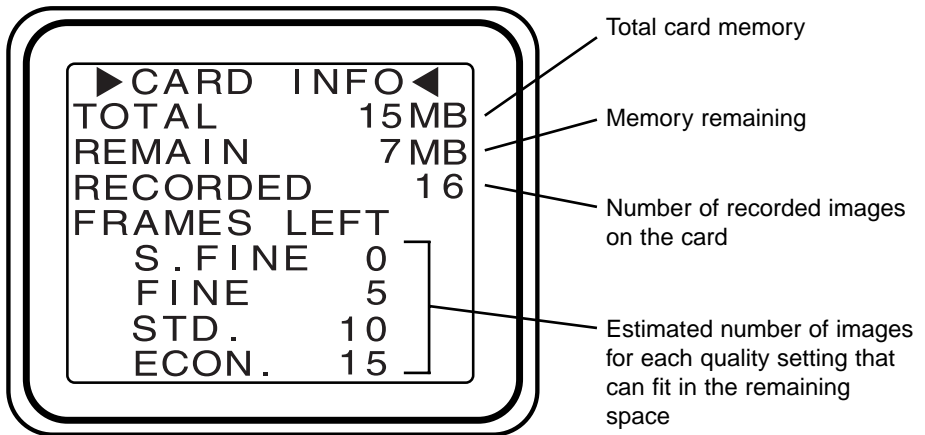

- The displayed value for the remaining number of frames which may be displayed is only a guide. Depending on the scenes photographed, it may not be possible to display this number of frames in practice.

### 4 Press the SET button on the back of the camera, or press the MENU button.

- The LCD monitor returns to the normal play screen when the SET button is pressed. The top menu screen appears when the MENU button is pressed.

## VIDEO OUT

It is possible to view images in the camera on your television. This camera has a video-out terminal which allows you to connect the camera to your television using the Video Cable VC-EX1.

- 1 Turn off the television and the camera.**
  - 2 Open the terminal cover on the camera.**
  - 3 Insert the mini plug end of the Video Cable VC-EX1 into the camera's video out terminal.**
  - 4 Plug the other end of the video cable into the video input terminal on the television.**
  - 5 Turn the television and the camera on.**
  - 6 Turn the camera's Control dial to PLAY.**
  - 7 Change the television to the video channel.**
    - The camera's Play mode display will appear on the television screen.
  - 8 Scroll through the images as instructed in the Viewing Images section (see page 88).**
- The camera's LCD monitor turns off when the camera is attached to the television.

## REPLACING THE CLOCK BACKUP BATTERY

The clock in this camera uses a 3V lithium battery (CR2025). If this battery is exhausted the clock settings in the camera will be lost when the main camera batteries are removed.

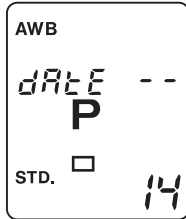

If this battery is exhausted the display at left appears on the data panel when camera power is switched on, or when the shutter button is lightly pressed. In this case, replace the clock backup battery as described below.

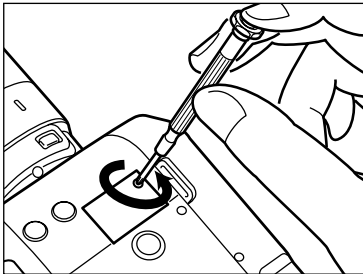

- 1 Remove the screw from the clock battery cover with a small Phillips screwdriver, and open it.**

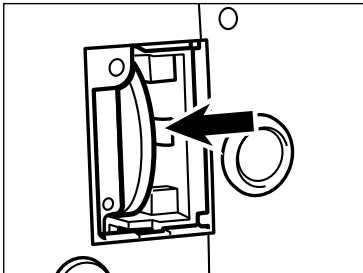

- 2 Remove the old battery.**
  - Push the battery out of the recess slightly (diagram at top left) and remove it (diagram at bottom left).

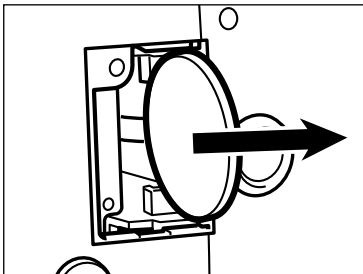

## REPLACING THE CLOCK BACKUP BATTERY

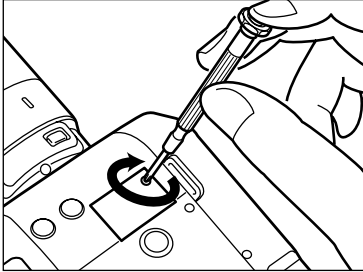
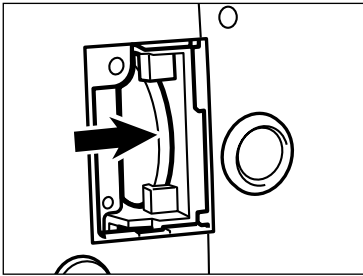
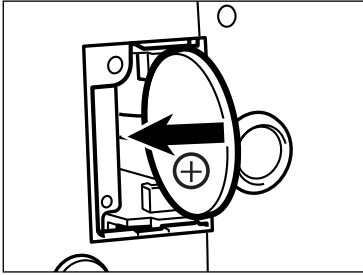

### 3 Insert the new battery.

- Press the battery into the recess until a click is heard (diagram at bottom left), ensuring that the + sign is on the left (diagram at top left).

### 4 Close the clock battery cover.

- The date and time will need to be reset (see page 28).

## CLEANING THE LENS IN THE RELAY OPTICAL SYSTEM

If dirt appears on the image on the screen, clean the lens in the relay optical system with the following procedure.

- The **bulb** function of this camera is used to clean the lens in the relay optical system. It is not to be used for extra-long exposures.
- Use of the **bulb** function requires considerable power from the battery, and it is therefore recommended that the AC adaptor be used with the camera when cleaning the lens in the relay optical system.

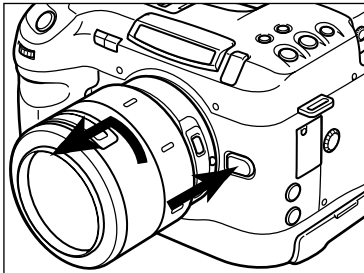

**1** Remove the lens.

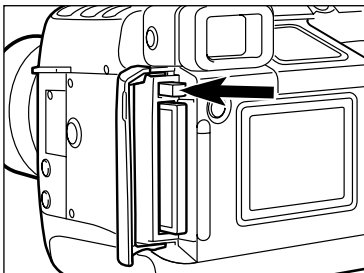

**2** Press in the card removal lever and remove the compact flash card.

- The **bulb** function cannot be set in step [4] unless the card is removed from the camera.

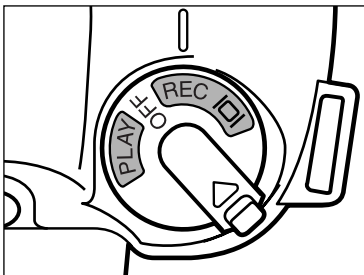

**3** With the Control dial lock button pushed in the  $\triangle$  direction, turn the Control dial to the left to the REC or  $\square$  position.

## CLEANING THE LENS IN THE RELAY OPTICAL SYSTEM

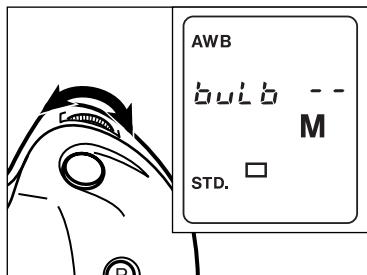

- 4 Select the **M (Manual)** mode (see page 56), turn the dial to display *bulb* in the shutter speed section of the data panel.

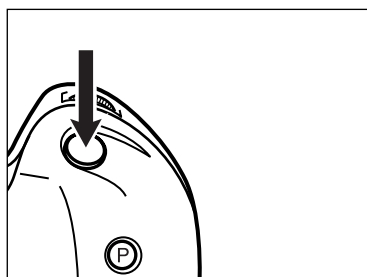

- 5 Gently press the shutter-release button and release it.

- The mirror remains raised, and the shutter curtain remains open, revealing the lens in the relay optical system.

- 6 Gently clean the lens with a blower or a cotton bud.

- Rub the lens gently.
- Do not use a blower powered with a gas bottle.
- Do not switch off the camera power supply, or remove the AC adaptor plug from the socket, when cleaning the lens.
- Do not use cleaners or organic solvents such as thinners or benzene under any circumstances.
- Do not touch the shutter curtain or mirror.
- If the dirt cannot be removed, or is difficult to remove, contact an authorized Minolta Service Facility listed on the back cover of this manual.

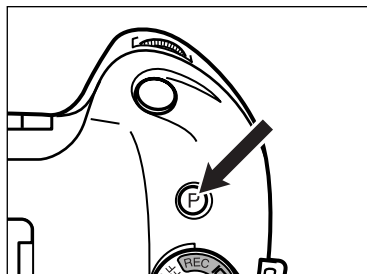

- 7 Press the program set button after cleaning is complete.

- The *bulb* function is cleared.





# APPENDIX

## ACCESSORY INFORMATION

This camera is designed to work specifically with lenses, flash units, and other accessories manufactured and distributed by Minolta. Using incompatible accessories with this camera may result in unsatisfactory performance or damage to the camera and accessories.

### Lenses

\* 35mm equivalents listed in parenthesis.

V Lens 22-80 f/4 - 5.6 (33-120mm)

V Lens 80-240 f/4.5 - 5.6 APO (120-360mm)

V Lens 28-56 f/4 - 5.6 (42-84mm)

V Lens 50mm f/3.5 Macro (75mm)

V Lens 25-150 f/4.5-6.3 (38-225mm)

V Lens 17mm f/3.5 RD (25mm) - incompatible with the Vectis S-1/S-100

### Flashes

- All Minolta i, si, and HS series flash units, as well as the Vectis SF-1 flash, are compatible with this camera. With these flash units, the flash will fire only when necessary when it is on and the camera is in P mode.
- For AF series flash units (4000AF, 2800AF, 1800AF, and Macro flash 1200AF), the flash Shoe Adapter FS-1100 is required. When the flash is on, it will fire every time the shutter is released. The AF illuminator will not activate.
- X-series flash units can only be used when connected to the camera's PC terminal by a sync cord.

### OTHER:

#### CompactFlash Cards RM-8C/RM-16C/RM-32C

#### Eyepiece Cup EP-RD1

#### PC Card Adapter CA-1C

This adapter allows Compact Flash card to be used in PCMCIA card drives (ATA PCMCIA Type II standard). This is convenient for quick data transfer.

#### PCMCIA Card Drive CD-10

The PCMCIA card drive is an external drive for your computer that reads and records PCMCIA cards. Compact Flash cards used in the camera can be used in this drive with the aid of the PC Card Adapter CA-1C. It is a convenient way to bring your images into your computer and it reduces wear on the camera.

### **Not Compatible**

Close-up Diffuser CD-1000

Eyepiece Connector 1000

Wireless Controller IR-1N

## FILE SIZE/CARD CAPACITY

The file size of the image is determined by the selected image Quality (see page 40). There are four image Quality (compression ratio) options; Super Fine, Fine, Standard, and Economy.

### ***IMAGE QUALITY AND FILE SIZE***

QUALITY	COMPRESSION RATIO	FILE SIZE (APPROXIMATE)
SUPER FINE	1:1	8000 KB
FINE	1:5	1500 KB
STANDARD	1:10	850 KB
ECONOMY	1:15	550 KB

### ***CARD CAPACITY***

QUALITY	Approximate Card Capacity 30MB CF Card
SUPER FINE	3 IMAGES
FINE	17 IMAGES
STANDARD	33 IMAGES
ECONOMY	52 IMAGES

- The file size and the card capacity for every image quality are approximate values only. The actual values will vary with the scenes photographed.

## CAMERA WARNINGS

MODE	DISPLAY	CAUSE	ACTION	PAGE
<b>P</b>	Shutter speed and aperture blink	Light level is beyond the range of available shutter speeds and apertures.	In bright light, attach a neutral density (ND) filter, use film with lower film speed, or reduce the overall brightness of your surroundings.  In low-light, use flash or another light source to increase the brightness of your surroundings	-
<b>A</b>	2000 or 2" blinks	Required shutter speed is beyond the range of the camera.	Select a larger/smaller aperture until the display stops blinking.	53
<b>S</b>	Maximum or Minimum aperture blinks	Required aperture is beyond the range of the lens	Select a faster/slower shutter speed until the display stops blinking.	55
<b>SPOT</b>	 blinks in the viewfinder	Light level is below the camera's minimum metering range.	Increase the brightness, cancel spot metering.	49
<b>ALL</b>	LEnS - - appears	Lens is not attached or is attached improperly.	Attach the lens, or disconnect and reattach the lens.	26

## CAMERA WARNINGS

MODE	DISPLAY	CAUSE	ACTION	PAGE
ALL	CArd and the frame counter appears.	The compact flash card is full.	Use one of the following options to reclaim space: <ul style="list-style-type: none"> <li>• Delete unwanted images.</li> <li>• Transfer images to a PC hard drive, then Clear or Format the card.</li> <li>• Clear or Format the card.</li> <li>• Use a new compact flash card.</li> <li>• Select a lower compression ratio.</li> </ul>	76 94 96
ALL	CArd appears and - - blinks in the frame counter.	The compact flash card is not formatted for this camera.	Format the compact flash card using this camera.	76
ALL	CArd appears and Er blinks in the frame counter.	Card error.	<ol style="list-style-type: none"> <li>1. Turn the camera off.</li> <li>2. Remove the compact flash card.</li> <li>3. Wait a few minutes, then reinsert the compact flash card and close the card-chamber cover.</li> <li>4. Turn the camera on.</li> </ol> <ul style="list-style-type: none"> <li>• If the icon still appears, turn the camera off and contact a Minolta Service Facility listed on the back cover of this manual.</li> </ul>	—
ALL	CArd appears with no frame counter.	There is no compact flash card in the camera.	Insert a compact flash card into the camera.	32

## CAMERA WARNINGS

MODE	DISPLAY	CAUSE	ACTION	PAGE
ALL	CUSr Er appears	There was an error creating the custom White Balance setting.	Try again.	60
ALL	dAtE - - briefly appears	The clock battery power is low.	Change the clock battery.	108

## TROUBLESHOOTING

Refer to these pages to determine the cause of a problem you are experiencing with your camera. If the information does not cover the problem which you are experiencing or the condition continues, contact your nearest Minolta Service Facility.

PROBLEM	CAUSE	SOLUTION
<b>NO DISPLAY APPEARS WHEN THE CAMERA IS SWITCHED ON</b>	Batteries are loaded incorrectly	Remove and reinsert the batteries.
	Batteries are exhausted	If the camera battery is exhausted, install a new battery.
	Camera malfunction	Turn the camera off, then remove and reinsert the batteries.  If normal operation does not resume or the camera malfunctions repeatedly, contact an authorized Minolta Service Facility.
<b>AUTOFOCUS DOES NOT WORK WHEN SHUTTER-RELEASE BUTTON IS PRESSED PARTWAY DOWN</b>	Situation is unsuitable for autofocus	Use focus hold or manual focus.
	Camera is set to the manual focus mode	Set to the autofocus mode by pressing the focus mode button.
	Subject is too close	Check the minimum focus distance for your lens.
<b>SHUTTER CAN NOT BE RELEASED</b>	Focus can not be confirmed	Use focus hold, or manual focus.
<b>FLASH PICTURE IS TOO DARK</b>	Subject is beyond flash range	Make sure the subject is within the flash range.



## CLEARING THE RELEASE LOCK

This camera is designed so that, when the compact flash card is inserted in the camera, the shutter does not operate until the lens is attached. When a lens other than those noted on P114, for example the astronomical telescope, is fitted this function must be cleared.

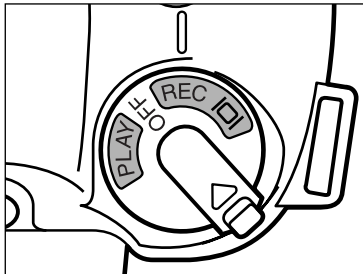
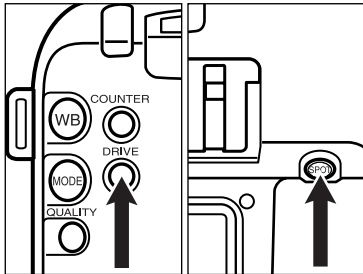

- 1 With the **DRIVE** button and the **SPOT** button pressed, turn the dial to **REC** or **|◻|**.

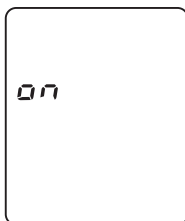

- 2 Release the two buttons if **OFF** appears on the data panel.
  - The release lock is cleared when the compact flash card is inserted while the lens is not fitted.
- To activate the release lock with the compact flash card inserted and the lens not fitted, use the same operation to display **ON** in the data panel and release both buttons.

### Cleaning

- If the camera or lens barrel is dirty, wipe it gently with a soft, clean, dry cloth.  
If the camera or lens comes in contact with sand, gently blow away loose particles – wiping may scratch the surface.
- To clean the lens surface, first brush away any dust or sand then, if necessary, moisten a lens tissue with lens cleaning fluid and gently wipe the lens in a circular motion, starting from the center.
- Never place lens fluid directly on the lens.
- Never touch the interior of the camera, especially the shutter and mirror.  
Doing so may impair their alignment and movement. Dust on the mirror will not affect the picture quality.
- Never use compressed air to clean the camera's interior, it may cause damage to sensitive interior parts.
- Never use organic solvents to clean the camera.
- Never touch the lens surface with your fingers.

### Storage

When storing your camera for extended periods, please follow these guidelines:

- Always attach the protective caps.
- Store in a cool, dry, and well-ventilated area away from dust and chemicals such as moth balls. For very long periods, place the camera in an airtight container with a silica gel drying agent.
- Periodically release the camera's shutter to keep it operating properly.
- Before using after prolonged storage, always check the camera's operation to make sure it is functioning properly.

### Before Important Events

- Always check camera operation carefully, or take test photographs.
- Minolta is not responsible for damages incurred by equipment malfunction.

### Questions and Service

- If you have questions about your camera, contact your local camera dealer or write to the Minolta distributor in your area.
- Before shipping your camera for repair, please contact an authorized Minolta Service Facility for details.

### LCD Monitor Care

The LCD monitor is a precision device with a pixel efficiency of 99.98%. Less than 0.02% of the pixels are dysfunctional.

- Do not apply pressure on the surface of the LCD monitor. Permanent damage may occur.
- In low temperatures, the LCD monitor will temporarily darken. When the camera warms-up, normal display will be restored.
- If the ▲ or ▼ buttons are pressed rapidly during playback, images may appear to overlap. This is normal and the image data is not changed.
- If the LCD monitor surface is dirty, first blow away dust or sand, then gently wipe it with a soft, clean, dry cloth.
- If the LCD display blinks continuously or no longer works at all, it is time to replace the monitor. Take the camera to your dealer or contact a Minolta Service Facility listed on the back cover of this manual.

# TECHNICAL DETAILS

## TYPE

SLR type digital camera with interchangeable lenses.

## CCDs

Two 1/2 inch 1.5 million pixel, progressive CCDs

Final Resolution: approx. 2.7 million

Filter: Primary colour, low-pass filter

Bit Depth: 24 bit colour

## IMAGE SIZE

1984 x 1360 pixels, Aspect Ratio: 1: 1.45

## AD CONVERSION

10 bit (8-bit output)

## EXPOSURE

Metering: 14-segment honeycomb-pattern metering, Spot metering selectable

Range: 14-segment honeycomb-pattern metering: EV 3-20

Spot metering: EV 6-20 (ISO200, f/3.5 lens)

Exposure Compensation: +/- 3 EVs in 1/2 EV increments.

Flash compensation: +/- 3 EVs in 1/2 EV increments.

ISO Equivalent: approx. ISO200/800 selectable

## SHUTTER

Type: CCD electronic shutter control and vertical traverse focal-plane shutter.

Range: P/A/S mode: 1/2000 - 2 sec.

M mode: 1/2000 - 30 sec.

Flash Sync: 1/125 sec. or slower

## LENS MOUNT

Minolta V mount (not all Vectis lenses compatible)

## AUTOFOCUS

Type: TTL phase-detection system

Sensor: One CCD line sensor

Focus Modes: Autofocus/Manual focus

## WHITE BALANCE

Automatic white balance setting. Manual setting available (daylight, tungsten, flash, custom)

## IMAGE STORAGE

Recording Media: CompactFlash Card

File Format: EXIF 2.0 (TIFF, JPEG)

Compression Ratio: SUPER FINE (TIFF 1:1), FINE (JPEG 1:5),  
STANDARD (JPEG 1:10), ECONOMY (JPEG 1:15)

# TECHNICAL DETAILS

## VIEWFINDER

Type:	SLR type, TTL replay-optical finder with acute matte
Field of view:	approx. 94% x 95%
Magnification:	0.8x
Diopter:	-4 to +2 diopters
Eye relief:	high eyepoint, 25 mm from the eyepiece lens

## DRIVE MODE

Single-frame advance, continuous advance (approximately 1.5 frames/second, up to 5 frames), Self-timer (approx.10 second delayed release), Remote -control (Ir, RC-3 sold separately)

## LCD MONITOR

Type:	2 inch, low temperature, poly-silicon, colour TFT LCD module.
Pixels:	approximately 110,000

## FLASH

Accessory shoe:	Minolta standard shoe
Minolta dedicated units:	Dynax/Maxxum flash units, Vectis flash units

## INTERFACE

Video Output:	NTSC
Digital:	SCSI 2

## POWER

Battery:	Camera power – Four AA-size Ni-MH batteries, Internal clock – One CR2025 3V lithium battery
Battery Performance:	Approximately 130 frames (based on Minolta's standard test method)
AC Power:	AC Adapter AC-2

## DIMENSIONS

(WxHxD)	150 x 117 x 101 mm
---------	--------------------

WEIGHT	Body: 910 g
--------	-------------

Specifications and accessories are based on the latest information available at the time of printing and are subject to change without notice.

A large, empty rectangular box with rounded corners, intended for writing a memo. The box is outlined in black and occupies most of the page area below the header and above the footer.

A large, empty rectangular box with rounded corners, intended for writing a memo. The box is outlined in black and occupies most of the page area below the header and above the footer.

**Minolta Co., Ltd.**

**3-13, 2-Chome, Azuchi-Machi, Chuo-Ku, Osaka 541-8556, Japan**

**Minolta Corporation**  
**Head Office**  
**Los Angeles Branch**  
**Minolta Canada Inc.**  
**Head Office**

101 Williams Drive, Ramsey, New Jersey 07446, U.S.A.  
11150 Hope Street Cypress, CA 90630, U.S.A.

369 Britannia Road East, Mississauga, Ontario L4Z 2H5, Canada

**Minolta GmbH**  
**Minolta France S.A.**  
**Minolta (UK) Limited**  
**Minolta Austria Ges. m.b.H.**  
**Minolta Camera Benelux B.V.**  
**Belgium Branch**  
**Minolta (Schweiz) AG**  
**Minolta Svenska AB**  
**Finland Branch**  
**Minolta Portugal Limitada**  
**Minolta Hong Kong Limited**  
**Minolta Singapore (Pte) Ltd.**

Kurt-Fischer-Strasse 50, D-22923 Ahrensburg, Germany  
365 Route de Saint-Germain, F-78420 Carrieres-Sur-Seine, France  
Rooksley Park, Precedent Drive, Rooksley, Milton Keynes, MK13 8HF, England  
Amalienstrasse 59-61, A-1131 Wien, Austria  
Zonnebaan 39, P.O. Box 6000, NL-3600 HA Maarssen, The Netherlands  
Kontichsesteenweg 38, B-2630 Aartselaar, Belgium  
Riedstrasse 6, CH-8953 Dietikon, Switzerland  
P.O.Box 9058, Albygatan 114, S-17109 Solna, Sweden  
Niittykatu 6 PL 37, SF-02201 Espoo, Finland  
Rua Afonso Lopes Vieira 55-B, P-1700 Lisboa, Portugal  
Room 208, 2/F, Eastern Center, 1065 King's Road, Quarry Bay, Hong Kong  
10, Teban Gardens Crescent, Singapore 608923

© 1999 Minolta Co., Ltd. under the Berne  
Convention and Universal Copyright Convention

9222-2757-31 P-A906

Printed in Japan



MINOLTA

**DIGITAL CAMERA**

***Dimâge***  
***RD 3000***

**E**

**CAMERA INSTRUCTION MANUAL**



## Free Manuals Download Website

<http://myh66.com>

<http://usermanuals.us>

<http://www.somanuals.com>

<http://www.4manuals.cc>

<http://www.manual-lib.com>

<http://www.404manual.com>

<http://www.luxmanual.com>

<http://aubethermostatmanual.com>

Golf course search by state

<http://golfingnear.com>

Email search by domain

<http://emailbydomain.com>

Auto manuals search

<http://auto.somanuals.com>

TV manuals search

<http://tv.somanuals.com>