

VECTIS 100 BF



Thank you for purchasing this Minolta camera. Your camera is an easy to operate lens shutter camera from Minolta's line of Advanced Photo System™ cameras.

This manual is designed to help you understand the operation of your camera and its functions. Please familiarize yourself with the names of the controls and their locations on the camera, then read this manual thoroughly.

Read and understand all warnings and cautions before using this product.

WARNING

Batteries may become hot or explode due to improper use.

- Use only the batteries specified in this instruction manual.
- Do not install the batteries with the polarity (+/-) reversed.
- Do not subject batteries to fire or high temperatures.
- Do not attempt to recharge, short, or disassemble.
- Tape over lithium battery before disposal. Follow local codes for battery disposal.

Use caution, accidents may occur when using this product near young children.

Keep batteries or things that could be swallowed away from young children. Contact a doctor immediately if an object is swallowed.

Immediately remove the batteries and discontinue use if...

- the camera is dropped or subjected to an impact in which the interior is exposed.
- the product emits a strange smell, heat, or smoke.

Do not disassemble. Electric shock may occur if a high voltage circuit inside the camera is touched. Take your camera to a Minolta Service Facility when repairs are required.

OPERATING TEMPERATURE AND CONDITIONS

- This camera is designed for use for -5°C to 40°C (23°F to 104°F).
- Never leave your camera where it may be subjected to extreme temperatures such as the glove compartment of a car.
- At colder temperatures, the data panel response time will be slow; at higher temperatures, the display will temporarily darken, but will restore when the temperature normalizes.
- Never subject your camera to extreme humidity.
- To prevent condensation from forming, place the camera in a sealed plastic bag when bringing it from the cold exterior to a warm building. Allow it to come to room temperature before removing it from the bag.
- When photographing in cold weather, we recommend that you keep the camera and spare batteries inside your coat to keep them warm when you are not shooting. Cold batteries will regain some of their charge when they warm up.
- This camera is not waterproof, dust-proof, or sand-proof; take care when using it at the beach or near water. Costly or irreparable damage may occur.

Advantages of the Advanced Photo System

Easier to load...

Advanced Photo System cameras use the new IX240 type film. This new film features drop-in-loading to make loading your camera simple, the first time, every time. Indicators on the cassette tell you and your camera if the film is unexposed, partially exposed, exposed, or processed.

VEI, Visual Exposure Indicators

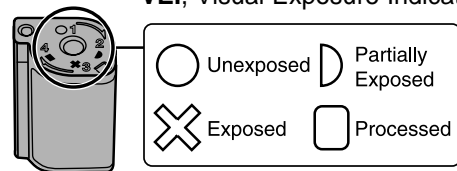

- This camera will only load film with the Unexposed ● mark current.
- DEP, Double Exposure Prevention, prevents the camera from accepting exposed film.

SPECIFICATIONS

Camera Type:	IX240 Lens shutter camera
Lens:	24mm f/4.5
Focusing Range:	0.8m - ∞ (2.6 ft. - ∞)
Film Speed Setting:	Automatic setting for ISO100, 200/400
Metering Range (ISO 200):	EV6 - EV16
Flash Range (ISO 200):	0.8 - 5.6m (2.6 - 18.2 ft.)
Battery:	CR2 (3V) lithium battery x 1
Battery performance:	Approx. 12 rolls with a CR2 lithium cell (based on Minolta's standard test method, using 25 exposure film with flash on for 50% of the exposures).
Viewfinder:	Magnification 0.64X
Dimensions WxHxD:	110 x 63.5 x 39mm (4.4 x 2.5 x 1.5 in.)
Weight:	155g (5.5 oz.)

Specifications are based on the latest information available at the time of printing and are subject to change without notice.

This device complies with Part 15 of the FCC Rules. Operation is subject to the following two conditions: (1) This device may not cause harmful interference, and (2) this device must accept any interference received, including interference that may cause undesired operation. Changes or modifications not approved by the party responsible for compliance could void the user's authority to operate the equipment. This equipment has been tested and found to comply with the limits for a Class B digital device, pursuant to Part 15 of the FCC Rules. These limits are designed to provide reasonable protection against harmful interference in a residential installation. This equipment generates, uses and can radiate radio frequency energy and, if not installed and used in accordance with the instructions, may cause harmful interference to radio communications. However, there is no guarantee that interference will not occur in a particular installation. If this equipment does cause harmful interference to radio or television reception, which can be determined by turning the equipment off and on, the user is encouraged to try to correct the interference by one or more of the following measures:

- Reorient or relocate the receiving antenna.
- Increase the separation between the equipment and the receiver.
- Connect the equipment to an outlet on a circuit different from that to which the receiver is connected.
- Consult the dealer or an experienced radio/TV technician for help.

This Class B digital apparatus meets all requirements of the Canadian Interference-Causing Equipment Regulations.



This mark on the bottom of your camera certifies that this camera meets the requirements of the EU (European Union) concerning interference causing equipment regulations. CE stands for Conformité Européenne (European Conformity).

New processing...

In addition to returning your prints in the format you selected, certified photofinishers will return your Advanced Photo System film in its original cassette with an index print. To order reprints, simply choose the images you want from the index print. No more searching through negatives to find the right frame.

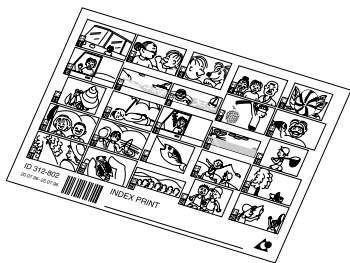

Advanced Photo System™ is a trademark of the five system developing companies.

New print formats...

Classic C print, wider H print, and panorama P print formats are available with Advanced Photo System cameras.



To receive the best possible prints, take your film to a photolab displaying the Certified Advanced Photo System logo. Photofinishers displaying this logo have been certified according to Advanced Photo System guidelines.



NAMES OF PARTS

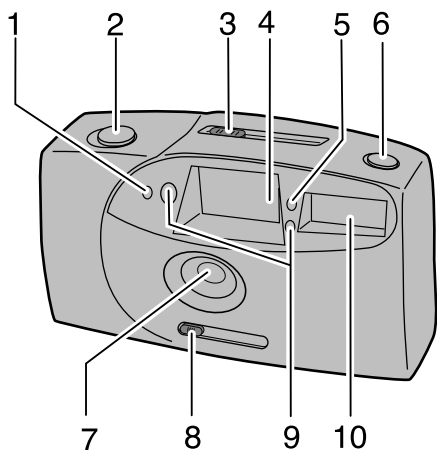

BODY TOP and FRONT

1. Meter window*
2. Shutter-release button
3. Format switch
4. Viewfinder window*
5. Self-timer/Red-eye reduction lamp
6. Self-timer button
7. Lens*
8. Lens-cover/Main switch
9. AF windows*
10. Flash*

* Do not touch

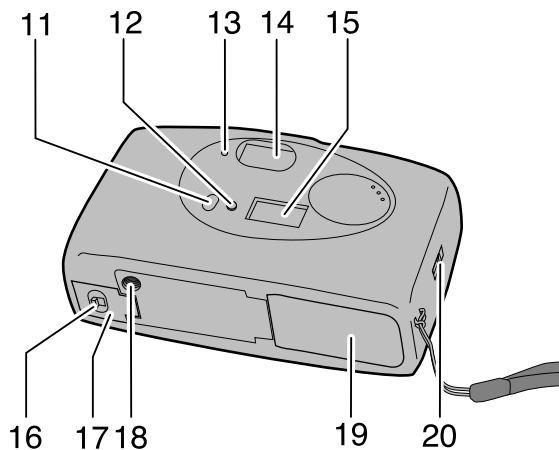

BODY BACK and BOTTOM

11. Mode button
12. Manual-rewind button
13. Flash-ready lamp
14. Viewfinder*
15. Data panel
16. Battery-chamber release
17. Battery-chamber door
18. Tripod socket
19. Film-chamber door
20. Film-chamber release

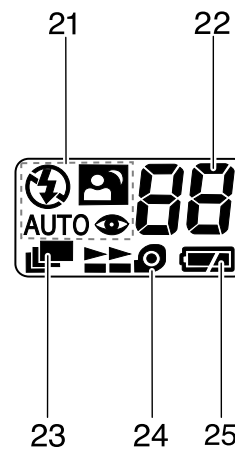

DATA PANEL

21. Flash mode indicators
22. Frame counter
23. Continuous drive indicator
24. Film-transport indicators
25. Battery-condition indicator

BASIC OPERATION

Step 1 INSERTING THE BATTERY

Your camera uses one 3-volt CR-2 lithium battery to supply power for all camera operations.

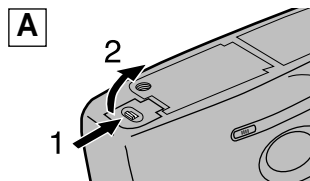

1. Slide the battery-chamber release in the direction indicated and open the battery chamber (A).

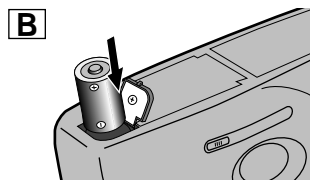

2. Insert the battery into the chamber with the - side entering first (B).
3. Close the battery-chamber cover until it clicks.
• To save power, your camera will shut down if it is not operated for more than five minutes. Close, then open the lens cover again to restore power.

CHECKING THE BATTERY POWER

Battery-condition indicator appears even with the camera off (C).



- : Power is sufficient for all camera operations.
 - : Power is sufficient, but the battery will have to be replaced soon.
 - : Replace the battery. The shutter will lock until the battery is replaced.
- No display: Replace battery or confirm it is inserted correctly.

- The frame counter is resets to 0 when you replace the battery if film is in the camera.

Step 2 LOADING THE FILM

Your camera uses IX240 type ISO100-400 speed film designed for use in Advanced Photo System cameras.

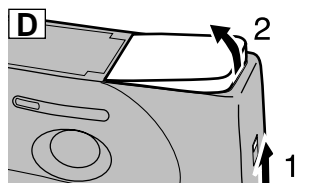

1. Turn the camera upside down and slide the film-chamber release in the direction indicated and open the film-chamber door (D).

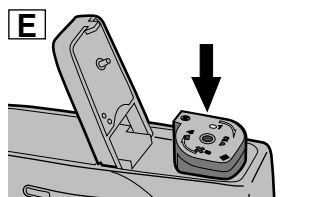

2. Insert the film cassette into the film chamber (E).
• This camera will only load film with the ● mark current.

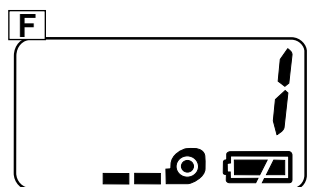

3. Close the film-chamber door until it clicks.
• The film will advance to the first frame, then and will appear in the data panel (F).
• If blinks in the data panel, open the chamber, then remove the film.
- Your camera cannot load a cassette if the current VEI (Visual Exposure Indicators) is , , or .- If a processed (VEI) or partially exposed (VEI) cassette was loaded into this camera, the VEI has been changed to .

Step 3 FULL AUTO OPERATION

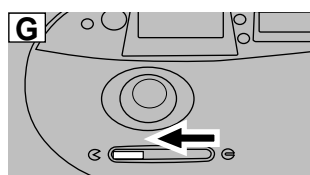

1. Slide the lens cover switch to to open the lens cover and turn the camera on (G).

2. Use the format switch to choose the print format (H).

- The viewfinder changes to match your selection.

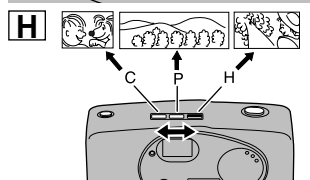

Hold the camera steady, making sure your fingers do not cover the flash. If you are taking a vertically framed picture, turn the camera so the flash is on top.

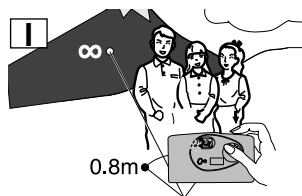

- Make sure the subject is within the focus distance of 0.8m - ∞ (2.6 ft. - ∞) (I).

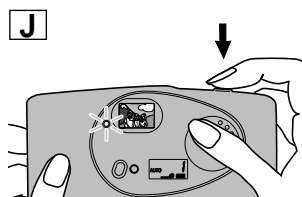

3. Center your subject in the focus frame, then press the shutter-release button partway down.

- If blinks in the data panel with the shutter-release button pressed partway down, and the green flash lamp blinks the flash is charging (J).

4. When the green flash lamp glows, press the shutter-release button all-the-way down to take the picture.

- After use, slide the main switch to to close the lens cover and turn the camera off.

FOCUS HOLD

When your subject is located outside the focus frame, you can first lock focus on your subject, then recompose the picture as desired.



1. Center your subject in the focus frame , then press the shutter-release button partway down (K).

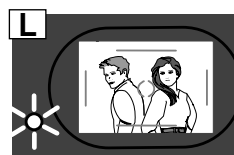

2. Without lifting your finger, recompose the picture, then press the shutter-release button all-the-way down to take the picture (L).

- Lift your finger from the shutter-release button to cancel focus hold.

Step 4 REWINDING THE FILM

AUTOMATIC REWIND

Your camera automatically rewinds the film into the cassette after the last exposure.

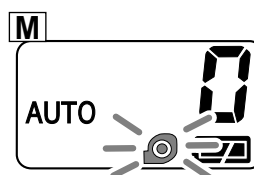

1. Wait for the film to completely rewind into the cassette.

- The frame counter will count down during rewind.
- will appear in the frame counter and will blink when the film is rewound (M).

2. Turn the camera upside-down and press the film-chamber release.

3. Open the film-chamber door and remove the film.

- The film's VEI indicator will be .

MANUAL REWIND

Use manual rewind to rewind the film before the roll is finished.

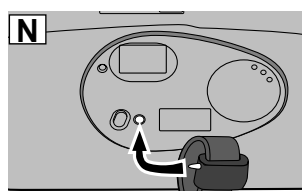

1. Gently press the manual rewind button key on the camera strap or similar object (N).





- Start rewind manually if automatic rewind does not start after you take the number of exposures specified on the film cassette. Additional exposures may overlap.

2. Follow steps 1- 3 from automatic rewind.

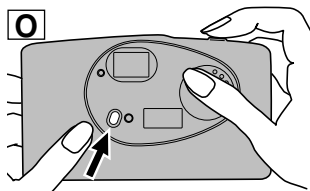
ADVANCED OPERATION

USING THE MODE BUTTON



The following modes can be selected:
Autoflash (**AUTO**),
Autoflash with red-eye reduction (**AUTO** ),
Manual fill flash (),
Flash cancel (),
Night portrait (),
Continuous mode () (**O**) (**P**).

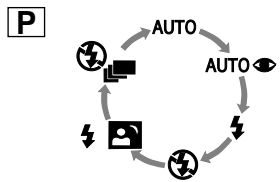

When you turn the camera on, the built-in flash is set to autoflash (**AUTO**).

- The range of the built-in flash depends on the film speed you are using. To ensure proper exposure, make sure your subject is within the flash range (**Q**).
ISO 200 0.8 - 5.6m (2.6 - 18.2 ft.)

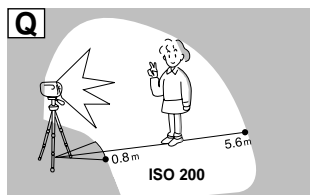



AUTO AUTOFLASH

The flash will fire automatically when the light level is low.

AUTO AUTOFLASH WITH RED-EYE REDUCTION

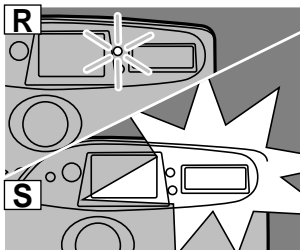
Use the red-eye reduction mode to reduce the red-eye effect when photographing in low light situations. The red-eye reduction lamp will glow for a moment before the flash fires and the picture is taken (**R**), (**S**). The flash will fire automatically when the light level is low.



Press the mode button until **AUTO**  appears in the data panel.

- The flash mode remains selected after the shutter is released.

MANUAL FILL-FLASH

The flash will fire with every shutter release, regardless of lighting. This can be used to reduce harsh, unflattering shadows on your subject's face.

Press the mode button until  appears in the data panel.

- The flash mode remains selected after the shutter is released.

FLASH CANCEL

With flash-cancel, the flash will not fire. This mode should be used when photographing twilight scenes, subjects that are beyond the flash range, or when flash photography is prohibited.

Press the mode button until  appears in the data panel.

- Shutter speeds may be slow when the flash is canceled. Use of a tripod is recommended.
- The flash mode remains selected after the shutter is released.

NIGHT PORTRAIT MODE

In night portrait mode, the camera balances the flash and existing light exposure so you can take beautiful pictures of people at sunset or at night. The flash is set to manual fill-flash.

Press the mode button until  appears in the data panel.

- The shutter speed will be slow. Use of a tripod is recommended.
- The flash mode will return to autoflash **AUTO** after the shutter is released.

CONTINUOUS-DRIVE MODE

In this mode, the camera continuously takes picture and advances the film as long as the shutter-release button is held down.

- This mode is recommended for use only in brightly lit scenes. Use in low-light situation may result in underexposure.
- Press the flash-mode button until  is displayed in the data panel.
 - Flash cancel and faster shutter speed is automatically selected.
 - Press and hold the shutter-release button all the way down.
 - The camera will release the shutter and advance the film as long as the shutter-release button is held down (**T**).
 - Continuous-drive mode remains selected after the series is complete.

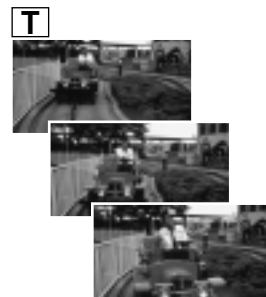

SELF-TIMER

The self-timer delays release of the shutter for approximately 10 seconds after you press the self-timer button.

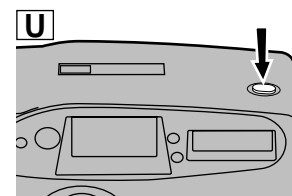

- Place the camera on a tripod, then center your subject in the focus frame.
- Press the self-timer button to activate the self-timer (**U**).

- The self-timer lamp will glow, then blink rapidly before the shutter is released (**V**).
- To cancel the self-timer, press the shutter-release button, the self-timer button, or turn the camera off.
- The self-timer is automatically canceled after the shutter releases.
- Do not press the self-timer button while standing in front of the camera.
- The self-timer does not operate in continuous-drive mode.

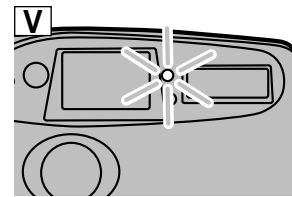

CARING FOR YOUR CAMERA

CLEANING

- Keep the AF and meter windows clean or the focus and/or exposure may not be accurate.
- If the camera body is dirty, gently wipe it clean with a soft, clean, dry cloth.
- To clean the lens surface, first brush away any dust or sand then, if necessary, moisten a lens tissue with lens cleaning fluid and gently wipe the lens in a circular motion, starting from the center.
- Never place lens fluid directly on the lens.
- Never touch the lens surface with your fingers.
- Never use alcohol or solvents to clean the camera.

BEFORE IMPORTANT EVENTS

- Check camera operation carefully or take test photographs.
- Minolta is not responsible for any loss which may occur due to an equipment malfunction.

STORAGE

When storing the camera for extended periods of time, please follow these guidelines,

- Store the camera in a cool, dry, well-ventilated area away from dust and chemicals. For very long periods, place the camera in an airtight container with a silica gel drying agent.
- Before using after prolonged storage, always check the camera's operation to make sure it is functioning properly.

QUESTIONS AND SERVICE

- If you have questions about your camera, contact your local camera dealer or write to the Minolta distributor in your area.
- Do not open the film chamber or forcefully remove the cassette if the film cannot be rewound. Contact an authorized Minolta Service Facility.
- Before shipping your camera for repair, please contact an authorized Minolta Service Facility for details.

Free Manuals Download Website

<http://myh66.com>

<http://usermanuals.us>

<http://www.somanuals.com>

<http://www.4manuals.cc>

<http://www.manual-lib.com>

<http://www.404manual.com>

<http://www.luxmanual.com>

<http://aubethermostatmanual.com>

Golf course search by state

<http://golfingnear.com>

Email search by domain

<http://emailbydomain.com>

Auto manuals search

<http://auto.somanuals.com>

TV manuals search

<http://tv.somanuals.com>