



KONICA MINOLTA

PagePro 1350W



Technical guide

www.konicaminolta.com/printer

The essentials of imaging

PagePro 1350W



Trademark Statement

All rights reserved. Specifications are subject to change without notice. The Konica Minolta logos, used trademarks, are trademarks or registered trademarks of Konica Minolta Holdings, Inc. All other trademarks or registered trademarks are the property of their respective owners or manufacturers.

Version 1.0 - November 2004

© 2004 Konica Minolta Holdings, Inc.

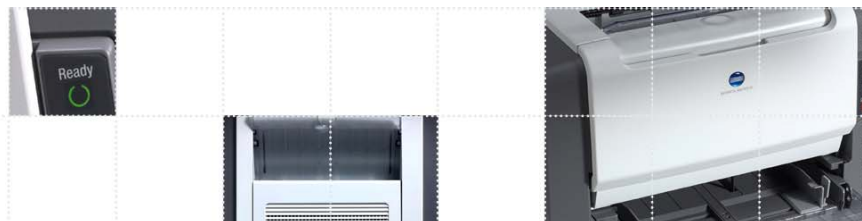

Contents

Introduction	4
Specs at a glance	5
Engine	6
<i>Duty cycle</i>	6
<i>Print speeds</i>	6
<i>First page out time</i>	6
<i>Physical dimensions</i>	7
<i>Operating environment conditions</i>	7
Controller	9
<i>Printer memory</i>	9
<i>Host computer requirements</i>	9
Paper handling	10
<i>Print media</i>	10
<i>Non-printable regions</i>	10
<i>Supported media sizes</i>	11
<i>Paper path</i>	12
Printer control	13
<i>Printer driver</i>	13
<i>Status Display</i>	14
<i>Printer control panel</i>	15
<i>Cancel button</i>	15
Consumables	16
<i>Toner cartridge</i>	16
<i>OPC drum cartridge</i>	16
On-line support	23
Information	24

PagePro 1350W

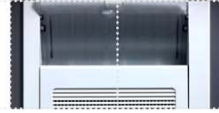

Introduction

The PagePro™ 1350W is a simple-to-use, low-cost, reliable printing solution for users needing to print professional business documents efficiently.



The PagePro 1350W is a compact yet very fast personal laser printer. At 20 pages per minute, this printer rivals the speed and print quality of much larger laser printers that customers may have used in the past. Most printers of comparable size to the PagePro 1350W cannot match its speed.

KONICA MINOLTA has designed the PagePro 1350W to be extremely easy to use. It functions seamlessly with computers running Windows XP, 2000, Me, and 98SE. It includes all drivers and utilities necessary for installing and operating the printer in any small or medium-sized office, including home offices. Maintaining the PagePro 1350W is simple and straightforward. The toner cartridge and photoconductive drum (OPC) are separately replaceable for more economic use.

This *Technical Guide* is intended for use by KONICA MINOLTA sales personnel and our reseller partners. It includes complete information about the PagePro 1350W and provides helpful data that can help sales personnel explain the features of the printer to customers



PagePro 1350W



Specs at a glance

[*An overview of the PagePro 1350W printer features*](#)

The PagePro 1350W is based on the Minolta NC-L701L laser printer engine. The engine features selectable resolutions of 600 x 600, 1200 x 600, and 1200 x 1200 dpi. (At 1200 x 1200 dpi, the print speed reduces by approximately half.)

Print method	Electrophotographic monochrome laser
Processor	Naltec N-1
Paper size	Up to A4
Print speed	Up to 20 pages per minute
Paper input	150 sheet multipurpose tray
Paper output	100 sheet face-down tray
Print resolution	True 1200x1200 dpi
Memory	8 MB on controller board
Interfaces	<ul style="list-style-type: none">▪ Bidirectional IEEE 1284 parallel▪ USB 1.1
First page out	13 seconds or less
Print media types	Plain paper, thick stock, OHP transparencies, laser-quality labels, envelopes
Duty cycle	Up to 15,000 prints per month
Software utilities	Printer drivers for Windows XP, 2000, ME and 98SE
Warranty	One year swap service (local law applies)
Special features	<ul style="list-style-type: none"><input type="checkbox"/> Midnight mode for silent printing<input type="checkbox"/> Hooks for convenient cable leading<input type="checkbox"/> Paper trays fixable in different positions

PagePro 1350W

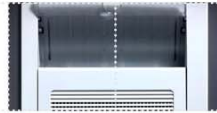

Engine

Excellent print quality and durability are hallmarks of the PagePro 1350W print engine.



The PagePro 1350W is based on the Minolta NC-L701L laser printer engine. The engine features selectable resolutions of 600 x 600, 1200 x 600, and 1200 x 1200 dpi. (At 1200 x 1200 dpi, the print speed reduces by approximately half.)

Duty cycle

15,000 prints (A4 size) per month maximum.

Print speeds by page size and resolution

Page size*	600x600 dpi 1200x600 dpi	1200x1200 dpi
Letter	16 ppm	8 ppm
Legal	12 ppm	6 ppm
A4	16 ppm	8 ppm
A5	16 ppm	8 ppm
B5	16 ppm	8 ppm

* Normal paper

Note: print speeds for 1200x600 dpi are the same as 600x600 dpi

First page out times

Page size*	600x600 dpi 1200x600 dpi	1200x1200 dpi
Letter	13 seconds	22 seconds
Legal	14 seconds	24 seconds
A4	13 seconds	22 seconds
A5	13 seconds	22 seconds
B5	13 seconds	22 seconds

* Normal paper

Note: First page out time for 1200x600 dpi is the same as 600x600 dpi



The PagePro 1350W produces high quality prints like the one above at full speed in both 600 dpi and 1200 x 600 dpi resolutions. Get 1200 x 1200 dpi resolution prints at 8 ppm.

PagePro 1350W

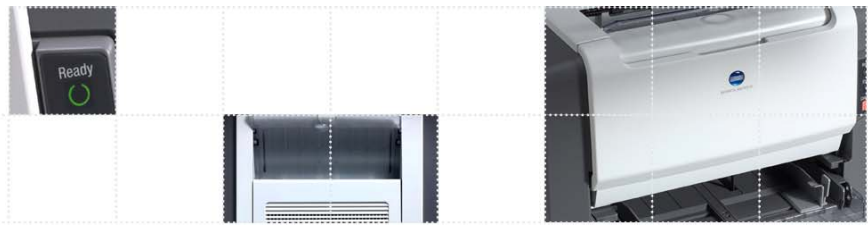

Physical dimensions

Packaging		
Width	Depth	Height
496 mm (19.5")	396 mm (15.6")	393 mm (15.5")
Printer (multipurpose tray extended)		
Width	Depth	Height
386.8 mm (15.2")	405 mm (15.9")	348 mm (13.7")
Weight		
Shipping	9.3 kg (20.5 lbs)	
Printer w/ consumables	7.8 kg (17.2 lbs)	
Printer w/o consumables	7 kg (15.4 lbs)	

Operating environment conditions

Power supply	100/120VAC, 50/60 Hz
Power consumption	<ul style="list-style-type: none">• 900W maximum• 400W or less (printing)• 15W (Energy Saver)
Temperature (operating)	10° -35° C (50°-95° F)
Humidity (operating)	15 - 85% RH
Noise	<ul style="list-style-type: none">• 54 dB (printing)• 52 dB (Midnight Mode)• 35 dB (standby)

Use the Status Display to enable "Midnight Mode" quieter printing for all times or selected times during the day:

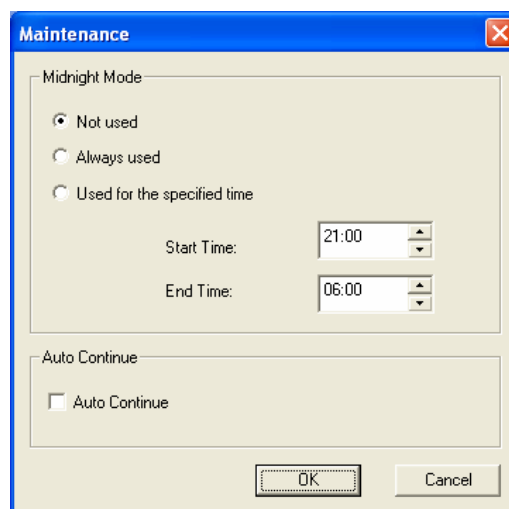



Clearance dimensions
(side view)

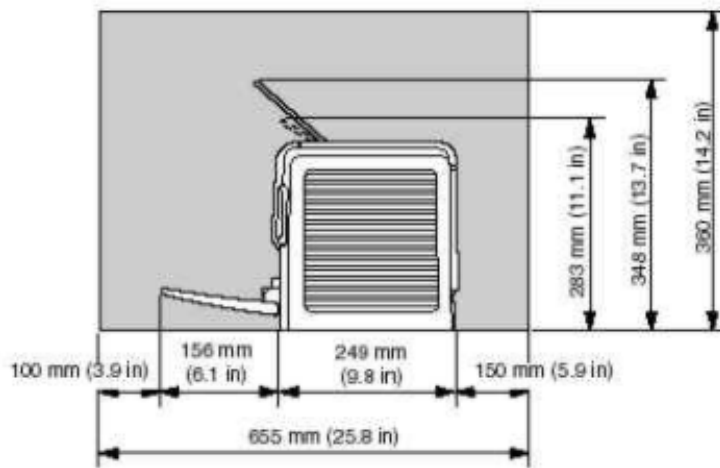

Clearance dimensions
(top view)

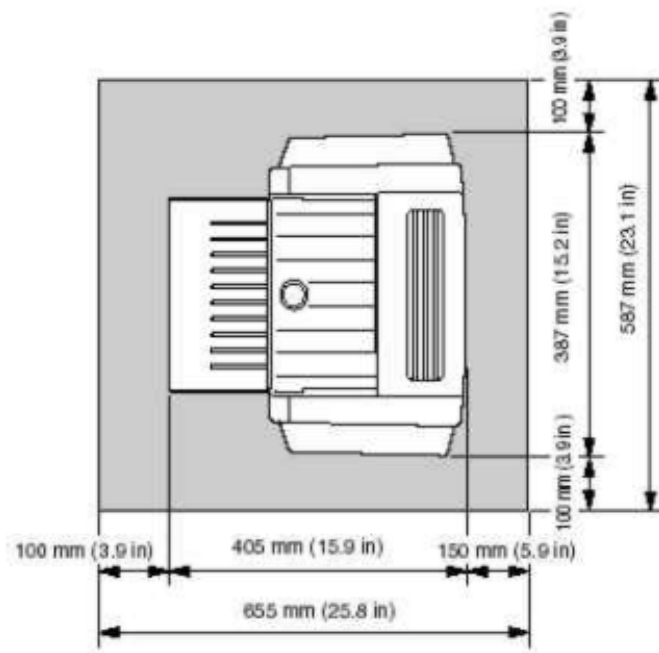



Controller

The PagePro 1350W uses the power of the Windows operating system to deliver great performance for less cost.

The PagePro 1350W supports the Graphical Display Interface (GDI) for Windows and, as such, utilizes the power of the host computer's Pentium-class CPU for processing documents prior to printing. The printer's controller features a Naltec N-1 ASIC for imaging the document.



Printer memory

The PagePro 1350W includes 8 MB of RAM on the controller. This memory is sufficient for printing all supported page sizes at all supported resolutions. There is no need for installing additional memory in the printer. Increasing memory of the host computer may improve transmission speed and overall performance of the printer.

Host computer requirements

PC Hardware	300 MHz Pentium-class CPU
Operating System	<ul style="list-style-type: none">• Windows XP• Windows 2000• Windows ME• Windows 98 SE
PC memory	<ul style="list-style-type: none">• 128 MB (XP)• 64 MB (2000)• 32 MB (ME)• 16 MB (98 SE)
Hard disk space	36 MB or more
CD-ROM	For installation of drivers and utilities
Interface	USB 1.1 IEEE 1284 parallel (ECP, Nibble, or compatible)

PagePro 1350W

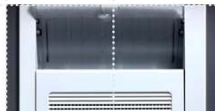

Paper handling

The PagePro 1350W supports a wide range of paper sizes to meet the needs of busy offices.

The PagePro 1350W includes a 150-sheet multipurpose tray for paper and other print media. The tray accommodates all supported page sizes up to 216 mm x 356 mm.



The multipurpose tray holds up to 150 sheets of paper.

Print media

The PagePro 1350W supports a range of print media to handle a variety of applications.

Supported media		
Normal paper	60 – 90 gsm	16 – 24 lb
Recycled paper	60 – 90 gsm	16 – 24 lb
OHP transparency	*	*
Envelopes	*	*
Letterhead	60 – 90 gsm	16 – 24 lb
Labels (sheet)	*	*
Thick stock	90 – 163 gsm	24 – 90 lb

** Must be certified for laser printer and capable of withstanding fusing temperature of 205° C (401° F)*



The output tray must be fully extended for proper stacking and full 100-sheet capacity.

Non-printable regions

The PagePro 1350W has a non-printable area of 4mm (0.16") from all page edges.

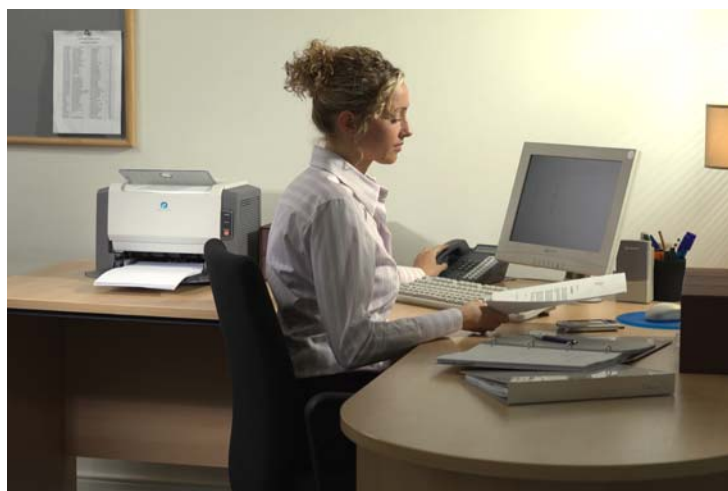

PagePro 1350W

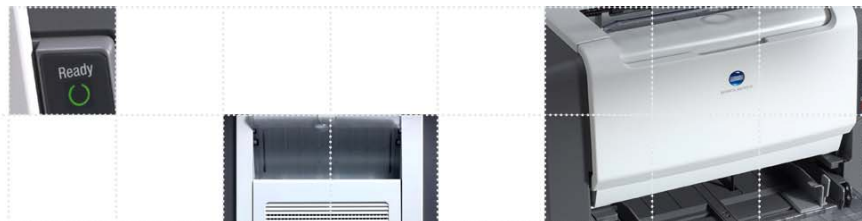

The PagePro 1350W's design motto was "Easy to own, easier to use".

Supported media sizes

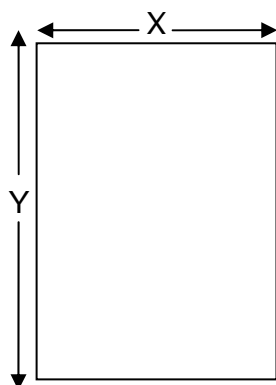

The table at right refers to X and Y dimensions of the media as diagrammed above.

Cut sheet	x-dimension	y-dimension
A4	210 mm	297 mm
B5 (JIS)	182 mm	257 mm
A5	148 mm	210 mm
Legal	8.5"	14"
Letter	8.5"	14"
G. Letter	8"	10.5"
Statement	5.5"	8.5"
Executive	7.25"	10.5"
Folio	210 mm	330 mm
Letter plus	8.5"	12.69"
UK Quarto	8"	10"
Foolscap	8"	13"
G. Legal	8.5"	13"
Chinese 16K	185 mm	260 mm
Chinese 32K	130 mm	185 mm
16K	195 mm	270 mm
Custom	76 mm (min) 216 mm (max)	127 mm (min) 356 mm (max)
Envelope		
B5 (ISO)	176 mm	250 mm
#10	4.125"	9.5"
C5	162 mm	229 mm
DL	110 mm	220 mm
Monarch	3.875"	7.5"
C6	114 mm	162 mm
Cho #3	120 mm	235 mm
Cho #4	90 mm	205 mm
Postcard		
Japanese postcard	100 mm	148 mm
Double postcard	148 mm	200 mm

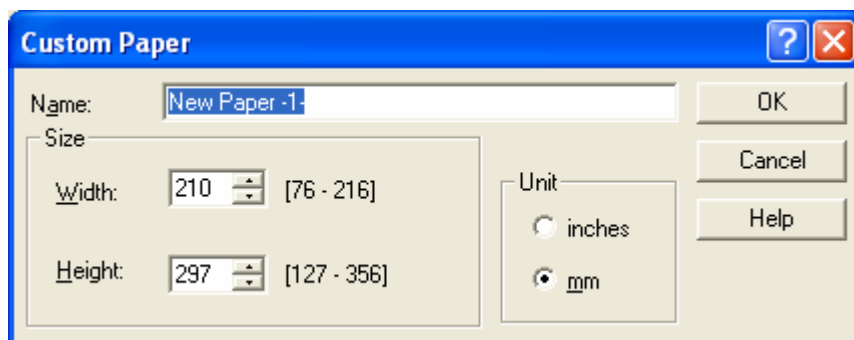

Define custom page sizes from the PagePro 1350W driver

PagePro 1350W



Paper path

The PagePro 1350W handles both standard weight and thick stock through the paper path.

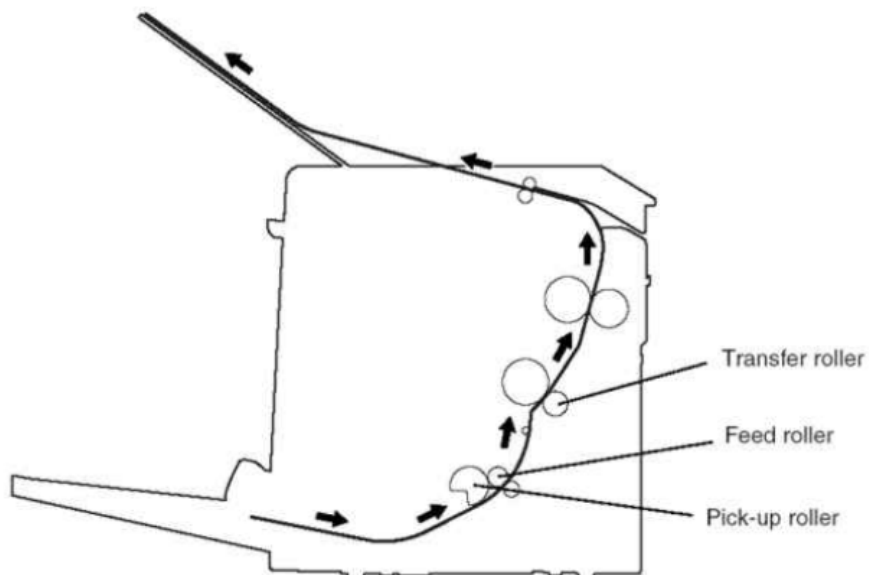

Lift the printer's rear cover to remove a paper jam.



PagePro 1350W



Printer control

The drivers and utilities included with the PagePro 1350W give the user complete control of all printer functions.

The PagePro 1350W offers these convenient tools for printer control included on a CD-ROM shipped with the printer:

- Printer drivers for all supported version of Windows
- User documentation (PDF format)
- Status Display

Printer driver

The driver for the PagePro 1350W is very easy to use – see below for descriptions of each tab.

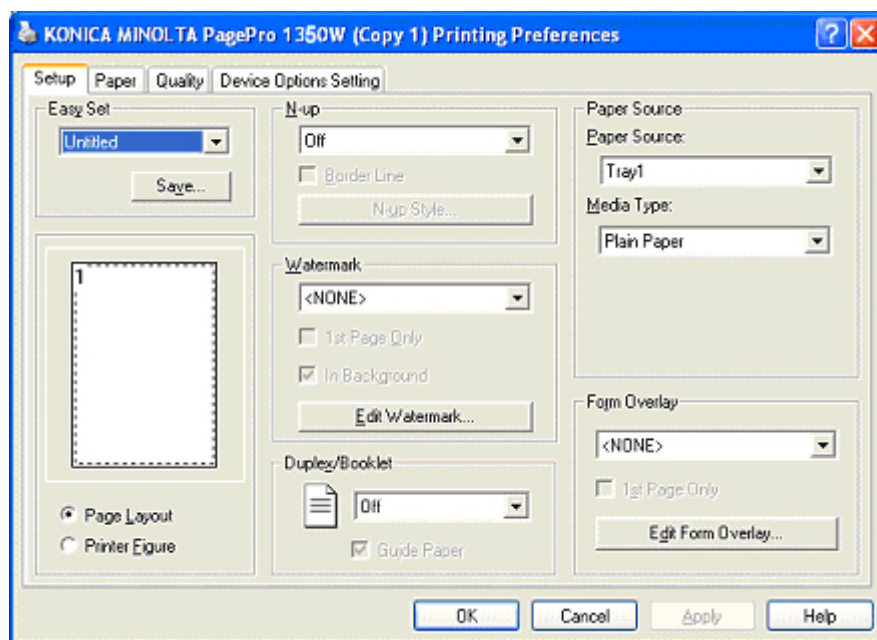

The PagePro 1350W features a tabbed layout that conforms to Microsoft standards making it very simple to understand. Use Easy Set to save often-used settings for various documents.

PagePro 1350W

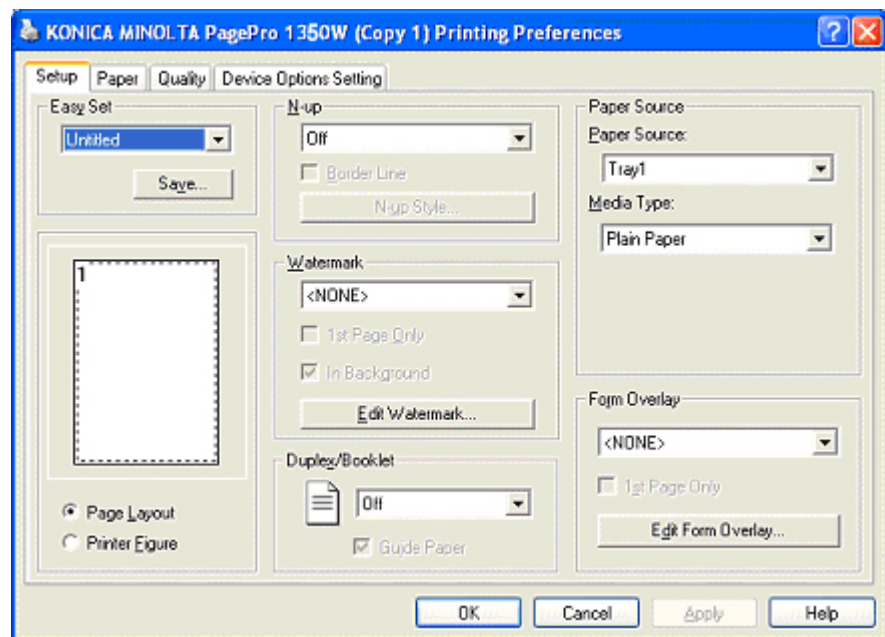

All paper handling settings are found under the “Paper” tab.

Status Display

The Status Display provides detailed information about the printer including current levels for consumables and explanations of any errors that may occur.

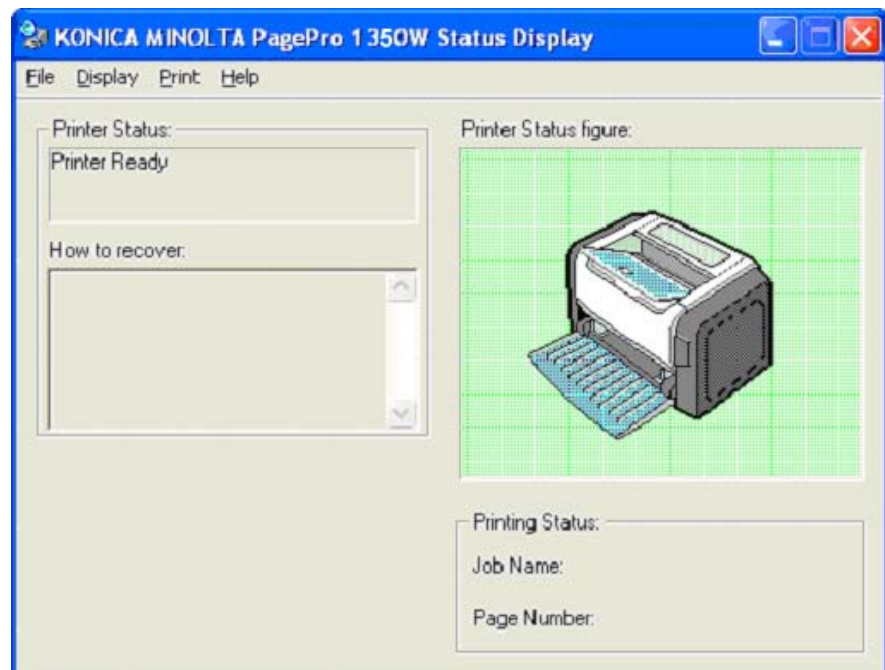

The Status Display automatically establishes communication with the printer whenever the host PC powers on.

PagePro 1350W



Printer control panel

The PagePro 1350W has two LEDs that indicate the status of the printer.



Ready	Error	Printer condition
Off	Off	Printer power off
On	Off	Printer ready
On	On	Initializing (or cancelling job)
Off	On	Printer cover open
Blink	Blink	Communication error
Off	Slow blink	Paper out
Off	Blink	Paper jam
Off	Rapid blink	Service call required
Rapid blink	Rapid blink	Paper size error (or waiting for manual duplex)
Blink	Off	Printing
Rapid blink	Off	Warming up
Slow blink	Off	Power save
On	Slow blink	Toner cartridge low
On	Blink	Toner cartridge empty
On	Rapid blink	Incorrect toner cartridge installed

Cancel button

Press and hold the **Cancel** button for more than 5 seconds to cancel the current job. In the event of a paper mismatch error (a paper size requested by the job is not loaded in the printer) or when manually duplex printing (using the PagePro 1350W driver), press the **Cancel** button for less than 5 seconds after reloading paper in the printer.

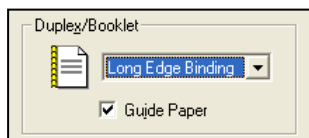

Select duplex printing for manually printing on both sides of the page. Use the **Cancel** button as directed.



Consumables

PagePro 1350W consumables are easy to replace and help keep printing costs down.



Toner cartridge

The PagePro 1350W includes a starter cartridge that holds enough toner for an average of 1,500 prints (5% coverage, A4-size, continuous printing). Two different replacement toner cartridges are available:

- Standard capacity (3,000 A4-size pages)
- High capacity (6,000 A4-size pages)

OPC drum cartridge

The printer includes one full-capacity OPC cartridge

- 20,000 pages (5% coverage, A4-size, continuous printing)

Use the Status Display to check the current level of toner in the PagePro 1350W. Click on "Order Supplies" to connect directly to the Q-Shop, Konica Minolta's site for purchasing consumables (Internet connection must be enabled)

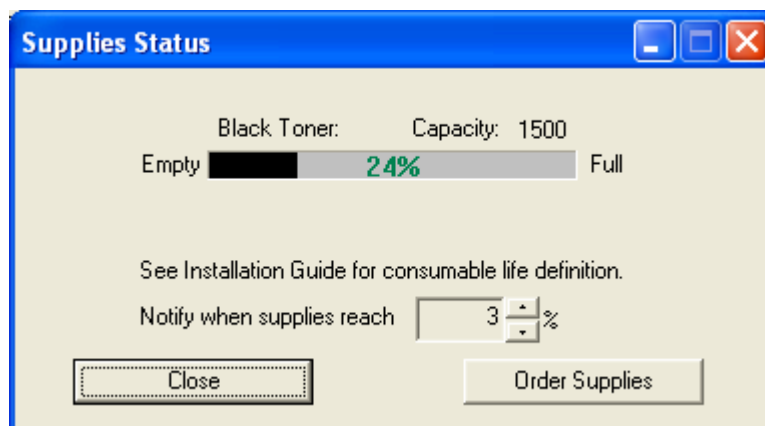

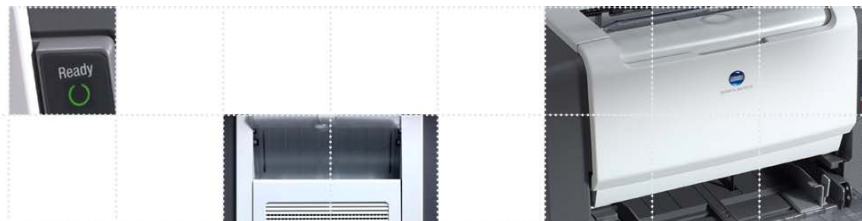

On-line Support

Konica Minolta provides the following on-line tools for marketing, sales, and end-user support:

GLOBAL SITE

Visit

<http://printer.konicaminolta.com/>
for the latest news, updates and drivers for the PagePro 1350W, and information about other printers.



PRODUCT CONFIGURATOR

To configure your PagePro 1350W to suit your specific printing requirements, use our Product Configurator – located at <http://printer.konicaminoltaeurope.com/configurator>



COMPARISON TOOL

For competitive product specification overviews and competitive knock-offs visit our product comparison tool at <http://printer.konicaminoltaeurope.com/comparison>



AWARDS SITE

A collection of some of the many awards our printers have won is available on: <http://printer.konicaminoltaeurope.com/awards>

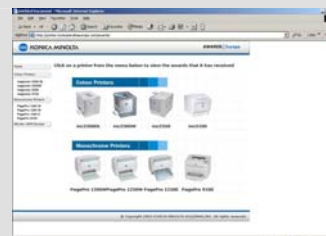

TCO CALCULATOR

Calculate the total cost of ownership of a printer, based on your own printing behaviour, at: <http://printer.konicaminoltaeurope.com/tco>

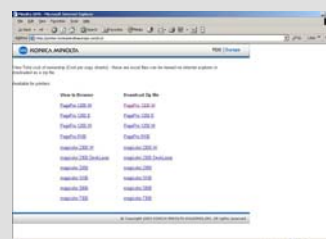

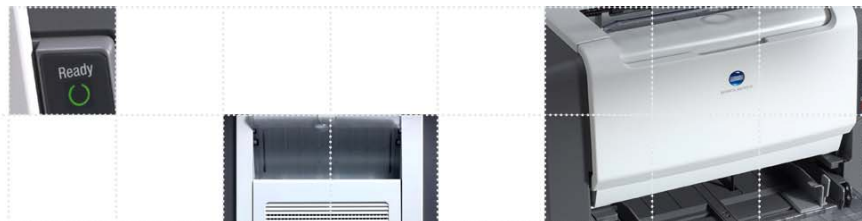

Information

Belgium and Luxemburg

Konica Minolta
Printing Solutions Europe B.V.
Tel: (+32) 2 – 479 64 23
Fax: (+32) 2 – 479 97 42

Denmark

Konica Minolta
Business Solutions Denmark a/s
Tel: (+45) 72 – 21 21 21
Fax: (+45) 72 – 21 21 22

Finland

Renatus OY
Tel: (+358) 9 4 20 61
Fax: (+358) 9 4 20 62 00

France

Konica Minolta
Printing Solutions France S.a.r.l
Tel: (+33) 01-41-07-93-93
Fax: (+33) 01-40-83-01-10

Germany and Austria

Konica Minolta
Printing Solutions Deutschland
GmbH
Tel: (+49) 89/63 02 67-0
Fax: (+49) 89/63 02 67-67

Italy

Konica Minolta
Business Solutions Italia S.p.a
Tel: (+39) 02 39 011 1
Fax: (+39) 02 39 011 219

Middle East

Konica Minolta
Printing Solutions Europe B.V.
Tel: (+97) 1 4 335 2574
Fax: (+97) 1 4 335 2573

Norway

Konica Minolta
Business Solutions Norway AS
Tel: (+47) 2 27 89 800
Fax: (+47) 2 27 89 850

Portugal

Konica Minolta
Business Solutions Portugal Lda
Tel: (+351) 217 81 47 00
Fax: (+351) 217 81 47 91

South Africa

Konica Minolta
Printing Solutions Europe B.V.
Tel: (+27) 011 – 249 4000
Fax: (+27) 011 – 249 4039

Spain

Konica Minolta
Business Solutions Spain S.A.
Tel: (+34) 91 327 73 00
Fax: (+34) 91 327 09 00

Sweden

Konica Minolta Business Solutions
Nordic AB
Tel: (+46) 8 – 622 51 00
Fax: (+46) 8 – 622 51 24

Switzerland

Konica Minolta Printing Solutions
B.V.
Tel: (+41) 1/740 96 40
Fax: (+41) 1/740 94 70

The Netherlands

Konica Minolta Printing Solutions
B.V.
Tel: (+31) 30 – 248 1200
Fax: (+31) 30 – 248 1211

United Kingdom and Ireland

Konica Minolta
Printing Solutions (UK) Ltd.
Tel: (+44) 1784 – 442255
Fax: (+44) 1784 – 461641

For all other countries

Konica Minolta
Printing Solutions Europe B.V.
Tel: (+31) 30 – 248 1200
Fax: (+31) 30 – 248 1211

Free Manuals Download Website

<http://myh66.com>

<http://usermanuals.us>

<http://www.somanuals.com>

<http://www.4manuals.cc>

<http://www.manual-lib.com>

<http://www.404manual.com>

<http://www.luxmanual.com>

<http://aubethermostatmanual.com>

Golf course search by state

<http://golfingnear.com>

Email search by domain

<http://emailbydomain.com>

Auto manuals search

<http://auto.somanuals.com>

TV manuals search

<http://tv.somanuals.com>