



FRS/Weather

Model: FRS-1000

Base Station With NOAA Weather Alert

Owner's Manual



For Customer Service
Visit Our Website At
www.audiovox.com
Product Information, Photos,
FAQ's, Owner's Manuals

Customer Service/Service
1-800-290-6650

© 2001 Audiovox Electronics Corp., Hauppauge, NY 11788



CAUTION

NEVER ATTEMPT TO CHARGE ALKALINE OR DRY CELL BATTERIES. WHEN RECHARGING, USE ONLY THE RECHARGEABLE BATTERIES SUPPLIED WITH YOUR TRANSCEIVER. USE OF OTHER BATTERIES WILL CAUSE DAMAGE TO YOUR FRS-1000 WEATHER RADIO TRANSCEIVER. OTHER TYPES OF BATTERIES MAY BURST CAUSING PERSONAL INJURY.

AVOID INSTALLING THE FRS-1000 TRANSCEIVER IN AN AREA WHERE IT MAY BE SUBJECTED FOR PROLONGED PERIODS OF TIME TO DIRECT SUNLIGHT OR TEMPERATURES BELOW -4° F (-20° C) OR ABOVE 140° F (60° C).

KEEP THE ANTENNA AT LEAST 1 INCH (2.5 cm) AWAY FROM YOUR HEAD AND BODY. DO NOT USE YOUR FRS-1000 RADIO TRANSCEIVER WITH A DAMAGED ANTENNA.

Family Radio Service:

The Family Radio Service (FRS) 2-way base (fixed) station "transceiver" ("transmitter and receiver") radio has been designed for family and friends to keep in touch without the need for a license.

It provides safety and convenience indoors for two-way radio operation between home base and other mobile FRS units, and operates on Family Radio Service designated frequencies.

The FCC has established the license free, short -range two- way radio service for family and individual recreational use.

The optimal range for this 2-way radio is approximately 2 miles in open areas; less in areas with buildings, dense foliage, and mountains.

Model FRS-1000

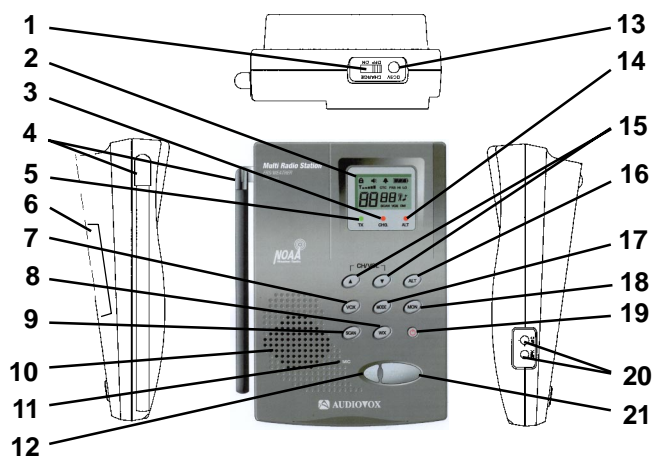

- | | |
|---|--|
| 1. Battery CHARGE On/Off Switch | 12. CALL Button |
| 2. Liquid Crystal Display (LCD) | 13. DC12V Power Jack |
| 3. Alert (ALT) LED (Red) | 14. Charging (CHG.) LED (Red) |
| 4. Antenna (Retractable) | 15. Up/Down Channel/Volume Buttons |
| 5. Transmit LED (Green) | 16. Weather Alert Button |
| 6. Battery Door | 17. MODE Button |
| 7. Voice-Operated Transmission (VOX) Button | 18. LCD Backlight/Monitor (L/MON) Button |
| 8. Weather/FRS Button | 19. Power On/Off and Function Set Button |
| 9. SCAN/Lock Button | 20. External Speaker(SPK)/Microphone (MIC) Jacks |
| 10. Built-in Speaker | 21. Push-To-Talk (PTT) Button |
| 11. Built-in Microphone | |

Model FRS-1000 DISPLAY

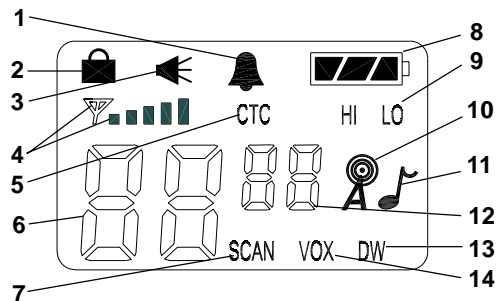

1. **Button (Key) Tone Beep On/Off Indicator:** This icon appears when the beep key tone is on, and disappears when tone is not in use.
2. **Key Lock Indicator:** Icon appears when keypad is locked. This function disables keys such as channel up/down and MODE.
3. **Monitor Indicator:** Icon appears when the Monitor (L/MON) button is pressed and the channel monitor function is activated.
4. **Signal Strength Indicator:** Icon appears when a signal is being received. The icon consists of five bars to indicate the received signal level. The icon also represents transmit signal power when transmitting.
5. **Continuous Tone Coded Squelch System (CTCSS) Indicator:** Icon appears when the CTCSS tone function is active.
6. **Large Segment Display:** Indicates the FRS channel number in use.
7. **Scan Indicator:** This function allows the user to scan a channel and/or a tone code every .5 second to search for a valid signal.
8. **Battery Level Indicator:** Icon indicates the battery charge level.
9. **HI/LO Indicators:** Appropriate icon appears when the transmit power is set to desired output power.

10. **Weather Mode Indicator:** Icon appears steady when weather mode is active; it flashes when weather alert is active in the FRS mode.
11. **Roger Beep Tone Indicator:** Icon appears when the roger beep tone is enabled, signifying transmission has been terminated. Icon disappears when tone is disabled.
12. **Small Segment Display:** Displays the CTCSS tone option for a given channel from (01-38).
13. **Dual Watch Mode Indicator:** Icon appears when dual watch mode is active.
14. **Voice Activated Transmission (VOX) Indicator:** This function allows hands-free conversation. The icon appears when the VOX mode is activated.

Powering the transceiver:

The primary power source for Your FRS-1000 base station is the AC wall adapter. The FRS-1000 is also supplied with a battery back-up, should you experience loss of household current. The FRS-1000 will automatically switch to battery back-up when AC power is interrupted. The rechargeable batteries, Part Number FRSRBAT, are charged in the radio transceiver using the AC power adapter, which is also supplied with the unit.

Installing the Back-Up Batteries:

The four AA batteries are installed in the compartment at the right rear of the transceiver; the compartment is fitted with a removable cover. Install the batteries as follows:

1. Press down with the thumb at the arrow, and slide the battery cover off the side of the unit.
2. Insert the four AA rechargeable batteries, Part Number FRSRBAT, provided. (Alternate positive ends (+) as shown in battery compartment layout.) Replace the cover.

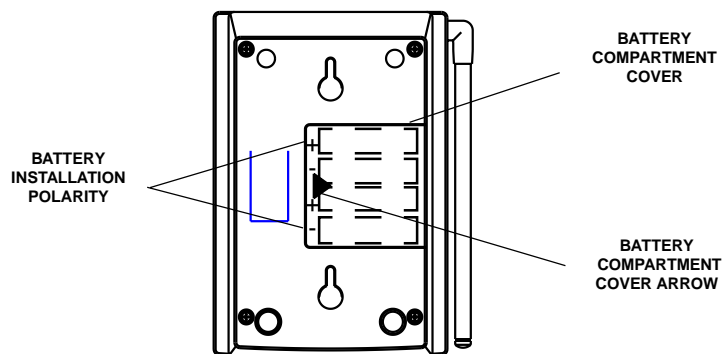

The following guidelines will improve performance and provide longer operating times for the FRS-1000:

1. Do not mix old and new batteries.
2. Do not mix alkaline, standard (carbon-zinc) or rechargeable (Ni-MH) batteries.
3. If the unit is not to be used for an extended period of time, remove the batteries. Old or leaking batteries can cause damage to the unit and will void the warranty.

Charging FRS-1000 Batteries P/N FRSRBAT:

The rechargeable batteries, Part Number FRSRBAT, supplied with the unit, are charged by connecting the AC Adapter plug to the **DC12V** jack on the top of the unit, and setting the **CHARGE** switch to the **ON** position. Use only the AC Wall Adapter, Part Number FRS1-AD, that is supplied with the base unit. The **CHG.** LED indicator below the LCD display lights **red** during battery charge operation.

The battery charge indicator icon displays the battery charge level when the AC adapter is unplugged. When the AC adapter is connected and in use, the indicator icon will indicate a full charge as shown below.



Full Battery - three segments are illuminated.

Low Battery - one segment is illuminated.

Approximately 20–24 hours are required to fully charge the batteries. The red LED charging indicator (14) will light whenever the batteries are charging. A flashing red LED charging indicator denotes batteries are not installed. You must set the CHARGE switch to the OFF position, when using any batteries other than the ones provided. Failure to do this may cause damage to batteries resulting in personal injury and/or damage to the unit.

Caution: The charging adapter is intended for use with the supplied rechargeable Ni-MH batteries Part Number FRSRBAT. Do not attempt to recharge any other type batteries.

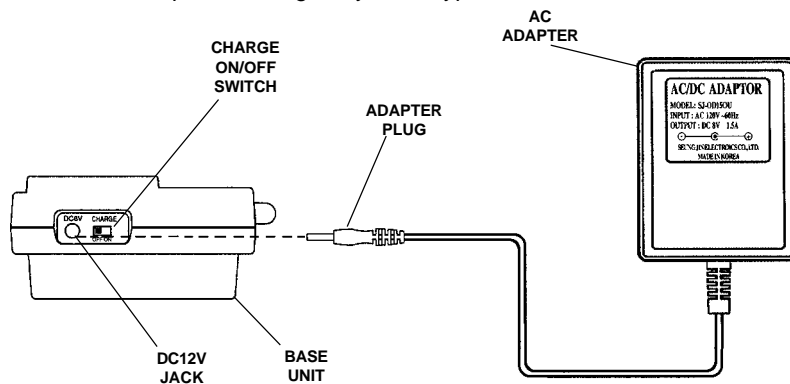

FRS-1000 OPERATIONAL MODES

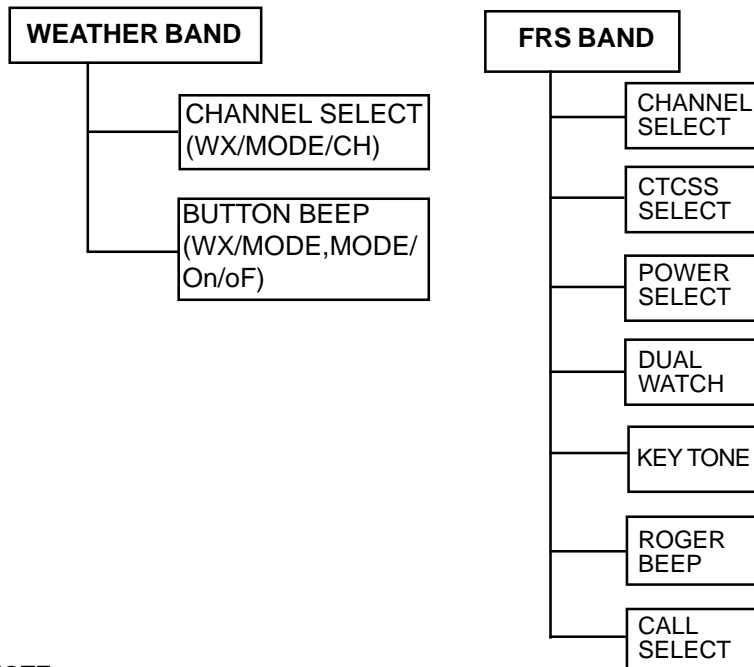

NOTE:



To switch between FRS and Weather Band modes, momentarily press the FRS/WX button. To differentiate between operating modes, look for **HI** or **LO** indication below the battery power level indicator when in FRS mode. In Weather Band mode, these indications are not present. Refer to the appropriate section of this manual for detailed operating instructions for each mode.

Controls:



Power On/Off (16) Button

Press and hold the power on/off button () for at least 2 seconds. You will hear a confirming melody to indicate the unit is on. To turn the unit off, press and hold the button for at least 2 seconds.

Adjusting the Volume

With the unit powered on, press the Up Channel/Volume button () to increase volume and the Down Channel/Volume button () to decrease volume. The display will indicate the current volume level by the small number adjacent to the icon ()

Monitor/Display (L/MON) Button (2)

This button is used to check activity on the current frequency before transmitting. Check activity by pressing the Monitor (L/MON) Button longer than 2 seconds; the  icon will appear on the display and you will hear static if frequency is clear. **Do not transmit if you hear conversation.** Hold down the L/MON Button again longer than 2 seconds and the  icon will disappear from the display.

The monitor function will temporarily bypass the squelch setting and play all signals on a given channel. This feature is useful when communicating with other parties at extreme range.

By pressing the monitor button momentarily, the LCD backlight is turned on; the LCD backlight will turn off automatically in about 5 seconds, or when the L/MON button is pressed momentarily once again.

Push To Talk (PTT) Button (4)

Pressing and holding this button will allow you to speak to any transceiver that is set to the same channel and privacy code setting as yours. After you have finished speaking, release the PTT Button to allow reception of incoming signals. It is not possible to transmit and receive at the same time. The Transmit (TX) LED at the lower left corner below the LCD Panel (8) will light **red** while the PTT Button is pressed, and the signal strength indicator will display the relative strength of the transmitted signal. Releasing the button

allows the unit to revert to standby mode. When receiving an incoming signal, the received signal strength indicator () will display the relative strength of the signal.

CALL Button (14)

The CALL Button can also be used as a two-way call ringer. Pressing the button will call another party on the same channel. The Transmit LED will light *red* for approximately 3 seconds and then go out.

Up Channel/Volume Button (10)

In the FRS standby mode, pressing this button () will increment the listening volume. When in function edit mode, this button will be used to adjust the unit's settings.

Down Channel/Volume Button (10)

In the FRS standby mode, pressing this button () will decrement the listening volume. When in function edit mode, this button will be used to adjust the unit's settings.

Mode Button (11)

In the FRS standby mode, pressing this button momentarily will enter the function edit mode. Subsequent presses will cycle to each mode.

The MODE button is used to select various features for adjustment in both the FRS and weather modes.

External Speaker (SPK)/Microphone (MIC) Jacks (6)

This set of jacks accepts an Audiovox headset/microphone connector. Refer to FRS-1000 Operational Modes.

Scan/Lock Mode Button (12)

Press this Button momentarily to enable or disable the scan mode. Press

and hold Button for more than 1 second to lock or unlock keypad functions, except PTT and Monitor (L/MON). When the keypad is locked, the () icon will appear in the upper right corner of the display.



FRS Operation

Channel Selection

In order to communicate with other FRS units, both transmitting and receiving party must be on the same frequency.

The FRS-1000 has 14 channels (frequencies 1-14) indicated by the large digits on the LCD display panel. Communication with Audiovox FRS and compatible units is possible on these 14 channels. Before transmitting on the selected channel, press the Monitor (L/MON) Button (2) to check the activity on that channel. If there is activity on the selected channel, change to another channel that is clear.

To change the FRS channel,

- From FRS standby mode, press the MODE button (11) until the channel number flashes.
- Press the Up Button () briefly to move to the next higher main channel number.
- Press the Down Button () briefly to move to the next lower main channel number.

Continuous Tone Coded Squelch System (CTCSS) Mode (Sub-Channel) Selection

The Coded Tone Controlled Squelch System (CTCSS) consists of 38 Sub-Frequencies. This feature allows you to utilize the coded squelch tones (01-38) within each main channel (1-14). This enables you to communicate with another party on the same main channel using the same subcode. The

CTCSS filters out unwanted transmissions without the same coded squelch tone). To change the CTCSS Sub-channel,

- From the FRS standby mode, press the MODE Button twice; the sub-channel number will flash as it is displayed. If **oF** is displayed, press the Up or Down button to enable the CTCSS mode; the **CTC** icon will appear steady on the display with the flashing sub-channel number.
- Then press the Up or Down button to select the desired sub-channel for use.
- Press the Power On/Off button momentarily to confirm selection.

The CTCSS mode can be turned off by selecting the **oF** icon with the Up or Down button.

NOTE: To communicate with other FRS units, they must be switched to the same channel and CTCSS subcode. To communicate with other FRS units that do not have subcodes, switch your unit to the same channel with the subcode set to **oF**.

The CTCSS subcodes do not prevent others from hearing your transmission. This will only allow you to ignore all traffic on a given channel not using the same subcode.

Transmit Power Selection Mode

This feature permits selection of the transmitting power level at high or low. When set to low, the transmit range of the unit will be less; however, battery life will be increased.

To access the transmitter power selection function:

- Press the Mode Button 3 times until the **Po** icon appears with a flashing **HI** or **Lo** indication on the display.
- Press the Up or Down button to toggle between the High and Low selections.
- Momentarily press the Power Button to confirm selection.

The display will indicate the current setting in standby mode.

Dual Watch Mode

This feature allows you to monitor two channels. While in dual watch mode, the unit will continuously monitor both the primary and dual watch channel. Received signals will be played for 5 seconds then the other channel will be scanned. Pressing the PTT button during a received transmission will set the unit to transmit on the same channel. Pressing the PTT button when no signal is received will set the unit to transmit on the primary channel.

To set the Dual Watch Mode:

- From the FRS standby mode, press the MODE button 4 times; the **DW** icon flashes on the display. If the dual watch mode is off, the **oF** icon will also appear flashing.
- To enable the dual watch mode, press the Up or Down button; the dual watch channel number will flash and start to increment up or down as the Up or Down button is pressed. The **DW** icon appears steady on the display.
- Press the MODE button again to enter the CTCSS function and select the desired CTCSS code for the dual watch channel previously entered.
- Press the Power On/Off button to confirm selection of the dual watch channel. The display will now alternate between the primary channel and the dual watch channel just selected.

Momentarily press the SCAN button to exit the dual watch selection mode.

Key Tone

This feature allows the transceiver to sound a tone whenever the following keys are pressed: Monitor (L/MON) Button, Up/Down Buttons, MODE Button, or SCAN Button.

To turn the key tones on or off,

- From the FRS standby mode, press the MODE Button 5 times until **bp**, the Bell () icon, and **On** or **oF** flash on the LCD display.
- Press the Up or Down Button to toggle the key tone feature On or Off.
- Momentarily press the Power Button to confirm your selection.

When the key tone feature is on, the Bell icon appears steady on the display, and the beep tones sound in response to each button activation.

Roger Beep Tone

The Roger Beep is a tone which is automatically transmitted whenever the PTT button is released. This tone alerts the receiving party that the transmission has been terminated intentionally.

To enable and disable the Roger Beep tone:

- From the FRS standby mode, press the Mode Button 6 times until **rb** appears on the display with the flashing Roger Beep icon (🔔) and **On** or **oF**.
- Press the Up or Down Button to select the tone on or off as desired.
- Momentarily press the Power On/Off Button to confirm selection.

When enabled, the tone icon (🔔) appears steady on the display.

Call Ringer Selection Mode

The transceiver provides 5 user-selectable call ringer melodies to alert you to an incoming call.

To select your favorite call ringer melody:

- From the FRS standby mode, press the MODE button 7 times; **CA** will appear on the display, together with a flashing number between **1** and **5**, and an appropriate call ring.
- Press the Up or Down Button to preview and hear the 5 available call melodies.
- Momentarily press the Power On/Off button to confirm your selection.

VOX Selection Mode

This option enables you to have hands-free conversation. Your voice or other relatively loud noises are detected and the radio transmits without the need to press the PTT button. To set radio for VOX operation,

- From FRS standby mode, press the VOX button; **Vo** appears steady and **VOX** icon and sensitivity level (if VOX is enabled) flashes on the display.
- Press the Up or Down button to select the desired VOX sensitivity level (1 is the most sensitive, 5 is the least sensitive, **oF** represents off).
- Momentarily press the Power On/Off button to confirm the VOX selection.
- The **VOX** icon will appear steady on the LCD display whenever the VOX feature is in use.

VOX can be turned off by selecting **oF** as the setting.

NOTE: When the unit is transmitting in the VOX mode, no functions on the unit will operate. To regain control of the functions, it may be necessary to reduce ambient noises.

Scan Operation

This feature allows you to monitor all channels and tone codes (CTCSS) automatically for valid signals. While scanning, you can transmit and receive. During reception, the scan function is interrupted and will return to the scan mode after 5 seconds.

To enable the channel scan mode,

- Momentarily press the SCAN Button; **(SCAN)** will appear on the LCD display.
- The radio will display each channel (1-14) in order as the scan mode operates to find an active main channel.
- When unit doesn't find any signals and you want to transmit, press the PTT switch to return to home channel operation. The transceiver will automatically resume scanning approximately 5 seconds after the transmission is completed.
- If there is no activity and you want to leave the scan mode, press the SCAN button momentarily and the unit will return to normal operation; **(SCAN)** icon will disappear from the LCD display.

CTCSS Scan Operation

This feature will scan all CTCSS codes for a single channel. It will pause to play any active transmissions then resume scanning 5 seconds after ending transmission. When in CTCSS scan mode the receiver will ignore uncoded transmissions. This feature is useful to establish communications with other users utilizing CTCSS coded transmissions.



To activate the tone code (CTCSS) scan mode,

- From FRS standby mode, press the MODE button twice to select the CTCSS function.
- Press the SCAN button; the radio will begin scanning for all tone codes **(01-38)** relative to the current main channel selection.
- To disable the tone code scan, press the SCAN button again, and the radio will return to normal operation with the same tone code at which the CTCSS scan function was stopped.

Auto Key Lock Selection Mode

This feature prevents accidental channel change to the preferred settings of the unit. The Auto Key Lock function temporarily disables the Up, Down and Mode Buttons.

To access the Auto Key Lock selection menu:

- From the FRS standby mode, press and hold the SCAN Button for over 2 seconds to Lock the Auto Key function; the () icon appears on the display.
- To unlock the Auto Key function, press and hold the SCAN button for at least 2 seconds; the () icon disappears from the display.

The PTT and Monitor Buttons are not effected.

Weather Band Operation

Channel Selection

This feature provides access to 10 channels within the weather band (7 NOAA channels and 3 Canadian marine channels). The radio must be in the weather channel mode. (Refer to FRS-1000 Operational Modes.)

To change the channel:

- From the Weather band standby mode, press the MODE button once until the channel number flashes.
- Press the Up button briefly to move to the next higher main channel number.
- Press the Down button briefly to move to the next lower main channel number.

Weather Alert Mode

Whether the unit is in FRS or weather band mode, if a weather alert signal is received, the unit will generate a warning tone. Press any key except the PTT button. The unit will then revert to a previously selected weather channel for monitoring purposes.

To access the weather alert function:

- From FRS or Weather Band standby mode, press the ALT button to access the weather alert function; the weather alert icon () appears flashing on the display, and the **ALT** LED lights **red**.
- Momentarily press the ALT button again to exit the Weather Alert function.

Additional Functions

When one or more segments of the battery () icon appear(s) flashing on the LCD panel, recharge unit or install new Audiovox approved rechargeable batteries. If this icon continues to flash on the LCD, please contact your authorized service center. Prior to contacting your authorized service center, please check the following:

1. Check the operating procedures.
2. Verify correct battery installation.
3. Install new, charged Alkaline batteries and check functions.
4. Check that AC adapter is plugged into a working AC power outlet.

NOTES FOR GOOD COMMUNICATION

1. The FRS-1000 14 channels are shared on a “take turns” basis. This means other groups may be talking on any of the channels. A common code of ethics/courtesy is to switch to another vacant channel and not to attempt to talk over someone who is already using the channel you first selected.
2. The FRS-1000 has been designed to maximize performance and improve transmission range to field units. To avoid interference, it is

recommended that you do not use base and field units closer than 5 feet apart.

3. For best transmission results, always keep your mouth about 2-3 inches from the microphone (11) and speak slowly in a normal voice.

Warning

- Remove the batteries from the transceiver if it is not expected to be used for long periods. This will eliminate the possibility of chemicals leaking from the batteries and corroding the transceiver.
- Avoid exposing the transceiver to water or extremes of temperature.
- Do not use this device in or near a mining facility, which uses remotely triggered explosives or in areas labeled "Blasting Area". Premature or accidental detonation may result.
- Do not attempt to modify or in any way increase the output of this transceiver. Its output is designed to meet the legal limits set by the FCC.
- Do not use this device or change its batteries in potentially explosive atmospheres as sparks in such areas could result in an explosion.
- Turn your transceiver off wherever posted notices restrict the use of radios or cellular telephones. Facilities such as hospitals may use equipment that is sensitive to RF energy.

Troubleshooting

Problem	Possible cause	Correction
No transmission while pressing the PTT Button	Weak batteries	Charge or replace batteries
	Incorrect battery polarity	Install the batteries following the directions in paragraph Installing the Batteries.

Troubleshooting (Cont.)

Problem	Possible cause	Correction
Weak or no signal received	Weak batteries	Charge or replace batteries
	Channel and privacy code not set the same as target transceiver transceiver	Adjust the transceiver's settings to match those settings of the target
	Volume level too low PTT Button inadvertently depressed	Increase volume level Release PTT Button
	Excessive radio interference on a particular channel Obstruction of radio signal	Change to a different channel Avoid operating in or near large buildings or vehicles
Unit beeps, but will not function when turned on	Batteries extremely discharged	Charge or replace batteries
Reception of unwanted signals	CTCSS privacy mode not on	Turn on the CTCSS privacy mode and set code number to match the setting of the target transceiver.
	Interference from electronic devices such as computers or TVs	Turn the devices off or move farther away from them.
Charge light flashes	Batteries are not installed and CHARGE switch (1) is on	Install Audiovox approved batteries

Technical Specifications:**General**

Frequency Range:	
FRS/Weather	Refer to frequency charts
FRS Channels	14
Privacy Codes	38 for each main channel
Dimensions (W x H x D)	4.625 in x 6.875 in x 2.375 in
(Without Antenna)	117.5 mm x 173.4 mm x 60.3 mm

Power Supply

Power Source	AC/DC Adapter
	Input: 120 Vac
	Output 12 Vdc, 0.5 Amp
Battery Backup	Ni-MH rechargeable, AA (4), 4.8 VDC, 1300 mA
Operating Time	30 hours
Battery Backup	(Transmit: Receive: Standby) (5: 5: 90 ratio)

Receiver

Useable Sensitivity	>0.22 uV
Maximum Audio Output Power	> 300 mW (8 Ohm)
Modulation Distortion	< 5% (1 kHz 70%)

Transmitter

Maximum RF Output Power	0.5 Watt ERP
High	0.5 Watt
Low	0.15 Watt maximum
Range	Up to 2 miles
Maximum Deviation	+/- 2.5 kHz
Modulation Distortion	< 5% (1 kHz 70%)

This transceiver complies with FCC regulations for use in the United States of America. Use in other countries may be prohibited or restricted by local regulation. Please check with the local regulating agency before using this device outside the United States of America.

FRS Channel Frequencies:

Channel	Freq. MHz	Channel	Freq. MHz
1	462.5625	8	467.5625
2	462.5875	9	467.5825
3	462.6125	10	467.6125
4	462.6375	11	467.6375
5	462.6625	12	467.6625
6	462.6875	13	467.6875
7	462.7125	14	467.7125

Weather Channel Frequencies:

Channel	Freq. MHz	Channel	Freq. MHz
1	162.550	6	162.500
2	162.400	7	162.525
3	162.475	8*	161.650
4	162.425	9*	161.775
5	162.450	10*	163.275

*Canadian Marine

**Continuous Tone Coded Squelch System Tone
Frequencies (in Hz)**

CTCSS	Freq. Hz	CTCSS	Freq. Hz
1	67.0	20	131.8
2	71.9	21	136.5
3	74.4	22	141.3
4	77.0	23	146.2
5	79.7	24	151.4
6	82.5	25	156.7
7	85.4	26	162.2
8	88.5	27	167.9
9	91.5	28	173.8
10	94.8	29	179.9
11	97.4	30	186.2
12	100.0	31	192.8
13	103.5	32	203.5
14	107.2	33	210.7
15	110.9	34	218.1
16	114.8	35	225.7
17	118.8	36	233.6
18	123.0	37	241.8
19	127.3	38	250.3

oF = No Tone

90 DAY LIMITED WARRANTY

Applies to Audiovox Family Radio and General Mobile Service Products.

AUDIOVOX CORPORATION (the Company) warrants to the original retail purchaser of this product that should this product or any part thereof, under normal use and conditions, be proven defective in material or workmanship within 90 days from the date of original purchase, such defect(s) will be repaired or replaced with new or reconditioned product (at the Company's option) without charge for parts and repair labor.

To obtain repair or replacement within the terms of this Warranty, the product is to be delivered with proof of warranty coverage (e.g. dated bill of sale), specification of defect(s), transportation prepaid, to the warranty center at the address shown below.

The Company disclaims liability for communications range of this product.

This Warranty does not apply to any product or part thereof which, in the opinion of the Company, has suffered or been damaged through alteration, improper installation, mishandling, misuse, neglect, accident, or by removal or defacement of the factory serial number/bar code label(s). THE EXTENT OF THE COMPANY'S LIABILITY UNDER THIS WARRANTY IS LIMITED TO THE REPAIR OR REPLACEMENT PROVIDED ABOVE AND, IN NO EVENT, SHALL THE COMPANY'S LIABILITY EXCEED THE PURCHASE PRICE PAID BY PURCHASER FOR THE PRODUCT.

This Warranty is in lieu of all other express warranties or liabilities. ANY IMPLIED WARRANTIES, INCLUDING ANY IMPLIED WARRANTY OF MERCHANTABILITY, SHALL BE LIMITED TO THE DURATION OF THIS WRITTEN WARRANTY. ANY ACTION FOR BREACH OF ANY WARRANTY HEREUNDER INCLUDING ANY IMPLIED WARRANTY OF MERCHANTABILITY MUST BE BROUGHT WITHIN A PERIOD OF 30 MONTHS FROM DATE OF ORIGINAL PURCHASE. IN NO CASE SHALL THE COMPANY BE LIABLE FOR ANY CONSEQUENTIAL OR INCIDENTAL DAMAGES FOR BREACH OF THIS OR ANY OTHER WARRANTY, EXPRESS OR IMPLIED, WHATSOEVER. No person or representative is authorized to assume for the Company any liability other than expressed herein in connection with the sale of this product.

Some states do not allow limitations on how long an implied warranty lasts or the exclusion or limitation of incidental or consequential damage so the above limitations or exclusions may not apply to you. This Warranty gives you specific legal rights and you may also have other rights which vary from state to state.

AUDIOVOX CORPORATION, 150 MARCUS BLVD., HAUPPAUGE, NEW YORK 11788

1-800-290-6650

128-5385A

Free Manuals Download Website

<http://myh66.com>

<http://usermanuals.us>

<http://www.somanuals.com>

<http://www.4manuals.cc>

<http://www.manual-lib.com>

<http://www.404manual.com>

<http://www.luxmanual.com>

<http://aubethermostatmanual.com>

Golf course search by state

<http://golfingnear.com>

Email search by domain

<http://emailbydomain.com>

Auto manuals search

<http://auto.somanuals.com>

TV manuals search

<http://tv.somanuals.com>