

Auto Refkeratometer
KW-2000

Operations Manual



RB-525-B04

INTRODUCTION

This manual contains information on correct handling and operational procedures as well as safety consideration pertinent to KW-2000

Before carrying out measurement and/or adjustment, read the instructions thoroughly so that effective operation is ensured. As this constitutes an important reference and user guide, keep it on hand at all times.

NOTE

- The information contained in this manual is subject to change without notice.
- While reasonable efforts have been made in the preparation of this document to ensure its accuracy, you should contact your local distributor immediately, if any quarries arise due to editorial errors or omissions etc.
- If you find any imperfect collating or missing pages, contact your local distributor for replacement.







SAFETY CONSIDERATION

KW-2000 is a Class I, Type B medical instrument as well as LED Class 2 product.
This instrument complies with Medical Device Directive 93/42/EEC.

A great deal of consideration has gone into the design and manufacturing of this instrument with regard to its operational ease, the patient's safety and well-being as well as to the reliability of the product. For safer and more effective use, however, follow the points described in this manual.

This instrument is designed for professional use.

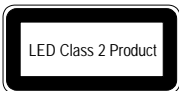
~ General Definitions of Safety Symbols ~

 CAUTION	Personal injury or physical damage may occur when this warning is ignored. General warning. Caution. Risk of danger.
	Denotes general ban or prohibition.
	General mandatory action.
	Caution of invisible LED radiation. Avoid exposure to beam. Indicated inside of the device.
	This device is an LED class 2 product.
 NOTE	Additional information which is important to the text or is useful/convenient to know.



CAUTION

- Always take great care when operating KW-2000. Malfunction or damage to the instrument could occur.
- Cut the power immediately if malfunction occurs during operation. Damage to the equipment or personal injury will result. Consult your dealer, if repair work needs to be carried out.



- At no time attempt to remodel or disassemble KW-2000. Damage to the instrument or personal injury will result.
- As KW-2000 is a precision optical instrument, operations must be carried out at all times by experienced, authorized personnel. Damage to the equipment or personal injury will result.
- Avoid installation near TV or radio. The reception can be disturbed by electrical noise. Follow the manual for the proper installation.
- Never remove the plug from the outlet if your hands are wet. Electric shock or personal injury could result.
- Make sure the power cord is not damaged. Fire or electric shock may occur.
- Do not touch the optical parts. Measurement accuracy will be adversely affected.



- The power cord must be firmly connected to an electrical ground (safety ground) at the power outlet. Personal injury may result from electric shock, etc.
- If the instrument fails to work properly, you should not try to repair the fault. Consult your dealer immediately.
- The instruction in this manual ensures correct operations.
- Observe the following environmental conditions for used and storage. Avoid dew condensation at all time.

	Temperature	Relative humidity
Use	+10°C to +40°C	30% to 85%
Storage	-10°C to +60°C	below 70%



Avoid the following conditions for storage and use of the instrument.

Where noxious gases or air pollutants are present.

- Where dust and grit may occur.
- Where oil fumes or greasy substances are emitted.
- Where there are atmospheric concentrations of salt.
- Near gas generation areas and places where dust accumulates.
- Keep in a secure, stable situation. Do not expose to strong vibrations (areas of seismic activity) and sudden shocks (this includes transportation) etc.
- Where there is an inclination of more than 10 degrees.
- Where voltage from the power sources rises or falls sharply during loading.
- Where fluctuations in the voltage of the power source occurs.
- Direct contact with sunlight.

If the instructions above are not followed, damage to the equipment or personal injury will ensue.

Contents

Introduction	1
Safety Consideration.....	1
Contents.....	2
Accessories.....	4
1. Parts Identification.....	5
2. Conveyance and Handling Procedure	6
3. Installation Environment.....	6
4. Safeguard Summary	7
5. Preparation.....	8
5.1 Setting	8
5.2 Applying Power	9
5.3 Standby	10
5.4 Switch Function	11
6. Measurement	12
6.1 Measurement Flow.....	12
6.2 Alignment	13
6.3 Measurement Results	14
6.4 Print Out	15
6.5 Kerato-Peripheral Measurement	16
6.6 IOL Measurement.....	18
6.7 Menu Screen Setting.....	19
6.7.1 Each Item Description	20
6.7.2 Optional Functions	23
6.8 Auto Start Function.....	27
6.9 Data Screen Function.....	29
6.10 Power Saving Function	30
6.11 Output Terminal.....	30
7. Tips for Effective Measurement.....	31
8. Error Messages.....	32
9. Contact Lens: Base Curve Measurement	33
10. Troubleshooting	34
11. Storage and Maintenance	35
11.1 Reloading Printer Paper.....	35
11.2 Fuse Replacement	36
11.3 Storage.....	36
11.4 Confirmation of Measurement Accuracy	37
11.5 Periodical Inspection and Maintenance	37
12. Specifications	38

Accessories

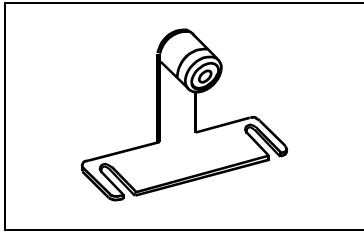

Model eye: 1
(with a contact lens holder)

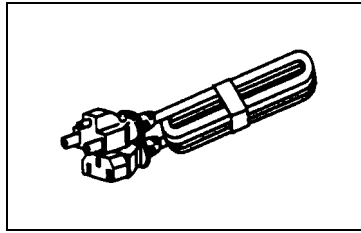

Power cord: 1
(2.5m)

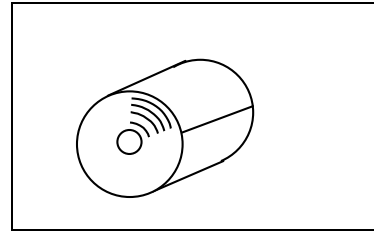

Printer paper role: 3
(width 57mm)
(Two packed and one installed into the body)

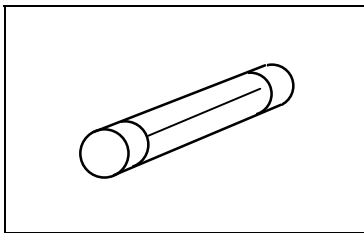

Fuse: 2
(T2A 250V)

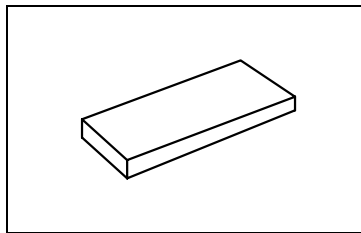

Pack of chin rest liners: 1
(1,000 sheets)

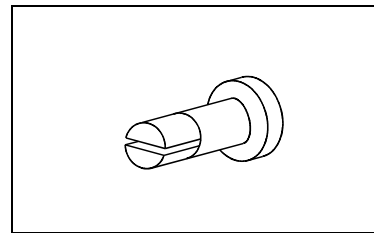

Chine rest liner pin: 2

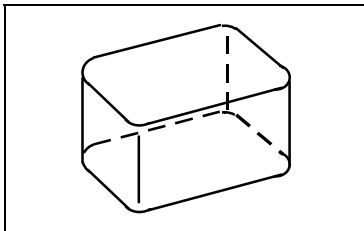

Dustproof cover: 1

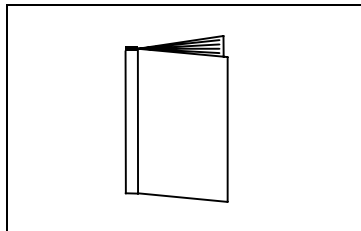

Operations manual: 1



Use accessories specified by us to avoid any malfunction or failure.



- Extra care should be taken for storage of a model eye. Avoid where the lens of the model eye may be damaged as well as any dusty or humid/steamy environments.
- Avoid direct sunlight, humidity and high temperature when storing printer paper which is a thermal paper.

1. Parts Identification

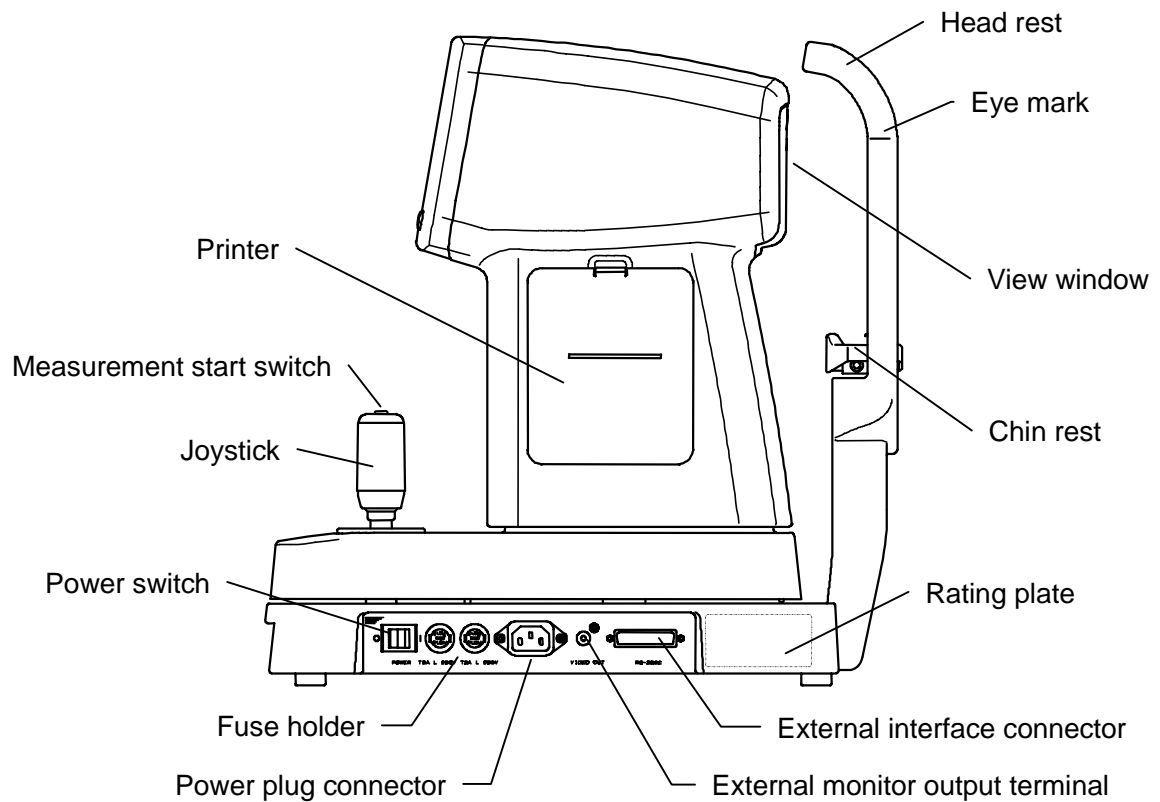
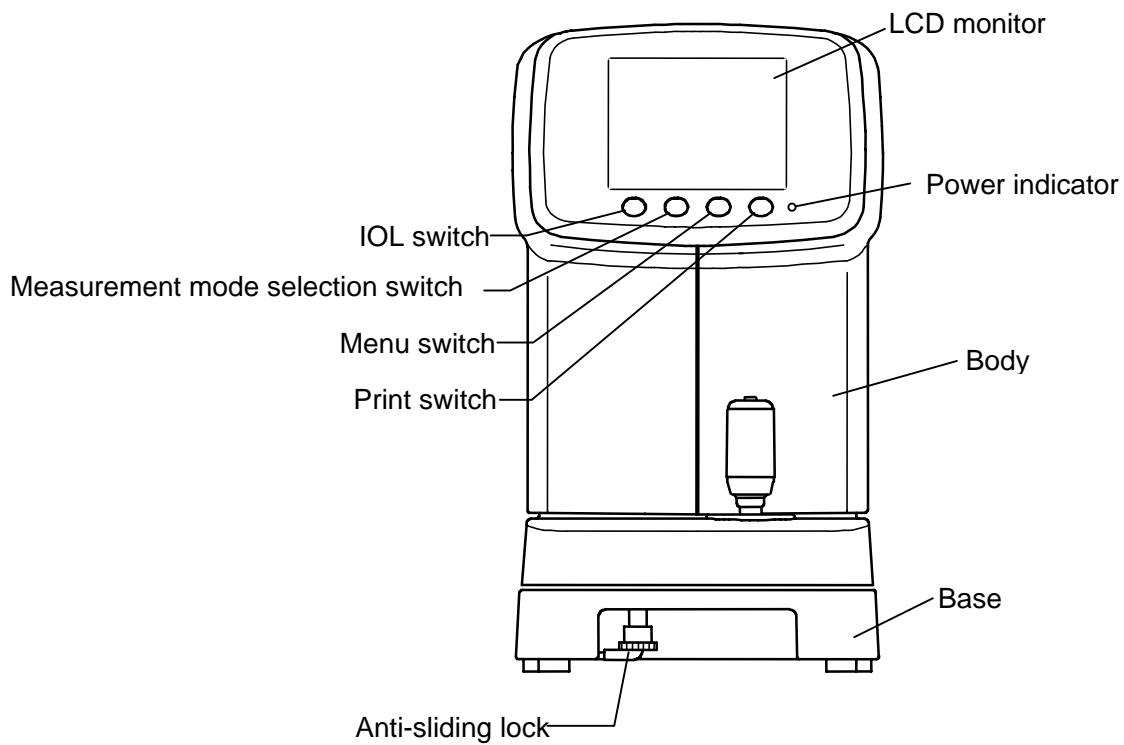

2. Conveyance and Handling Procedure

When transporting the instrument, make sure that the body has been securely locked.

Center the body onto the base so that their edges are aligned. Push down the lock while turning right until both body and base are firmly fixed to each other.

3. Installation Environment

- 1) Do not expose the instrument's view window directly to the sunlight or bright lighting from other sources.

Great care should be taken and avoid that the examinee is exposed to strong light or glare. The pupil will contract too much for measurement to be carried out.

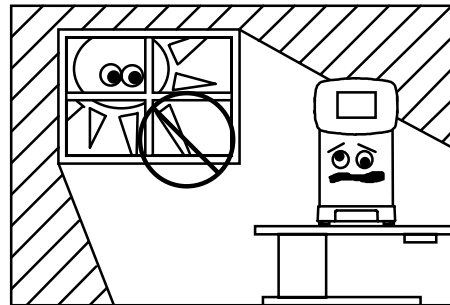

- 2) Do not operate in places where either dust or rubbish accumulates. Environment with extremes in heat and humidity should also be avoided.

Always follow the environmental requirements below for installation.

Temperature	+10 °C ~ -40°C
Relative Humidity	30 % ~ 85 %

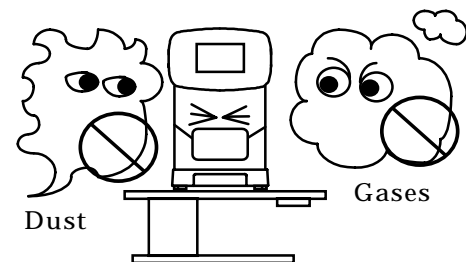

- 3) Keep away from inflammable or explosive gases as well as storage areas housing medical supplies and chemicals.

- 4) Avoid installing where dew condensation may accumulate. Also, avoid where the radical temperature changes may occur.

- 5) Keep away from sites that may experience strong vibrations or sudden shocks.

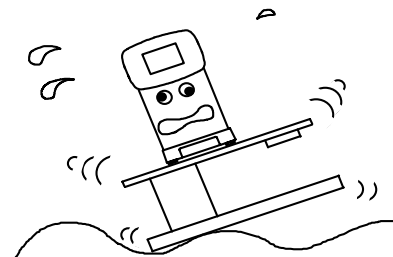

- 6) Malfunction is likely to occur if the instrument is improperly stabilized or accidentally overturns. To prevent internal/external damage caused by sudden impact, set the instrument on a solid and secure surface. Do not store in high, 'out of reach' places.

4. Safeguard Summary

1. KW-2000 is a precision optical instrument. Always handle with care and avoid dropping it accidentally.
2. Ensure that the instrument is properly grounded when connected to the power source.
3. Do not touch the optical parts with fingers and be sure to avoid dust, as their measuring accuracy could be adversely affected and incorrect values may result.



When dust or fingerprints appear on the optical part, use a soft cloth to wipe off the build-up. In case that the build-up is hard to remove, absolute alcohol is recommended. Take great care when cleaning these parts as they are particularly sensitive and fragile.

4. If the surfaces of the measuring unit and main unit including the control panel are dirty, gently wipe with a dry cloth. For hard to remove stains, a damp cloth or neutral cleanser is recommended.



Avoid using organic solvents that will damage the water based paint finish of the instrument.

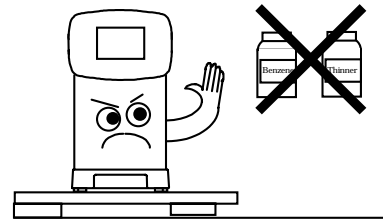

5. Clean the chin rest and head rest with the neutral cleanser. For disinfecting them, especially where the examinee may contact, hydrogen peroxide (Oxydol) is recommended.
6. If the instrument is not used for any length of time, remove the power cord from the outlet.

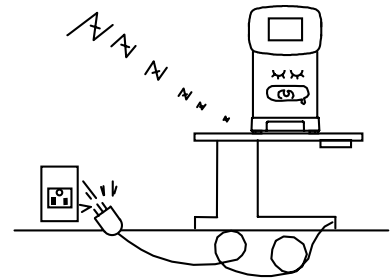

7. When not in use, protect the instrument with a supplied dustproof cover.
8. When the instrument fails to function properly, **never attempt to perform internal service or adjustment.** Contact your nearest registered agent, distributor or retail outlet.

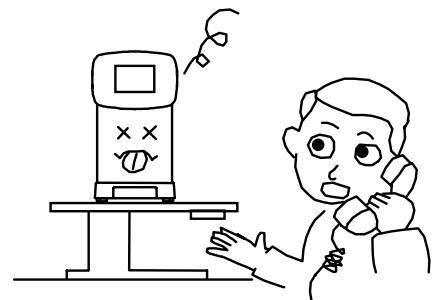

5. Preparation

5.1 Setting

- (1) Set a roll of printer paper in the printer. Refer to '11.1 Reloading Printer Paper' for the procedure.
- (2) Set and fix the chin rest liners with the chin rest liner pins on the chin rest.
Refer to the figure on the right.

 **NOTE** For sanitary consideration, disposing a sheet of the used chin rest liners after every measurement is recommended.

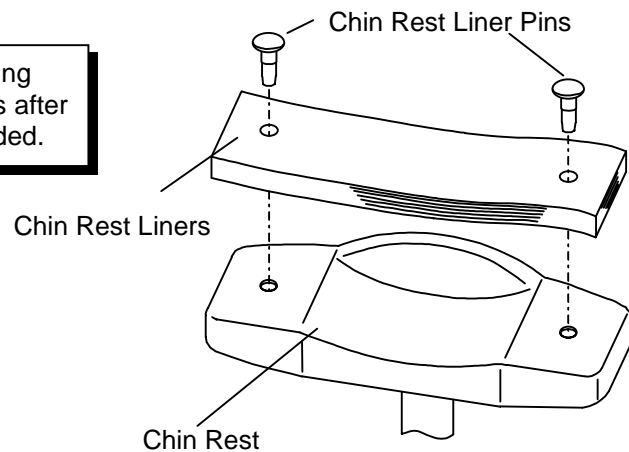

- Always use the chin rest liners following above.
- For sanitary consideration, disinfecting the chin rest with Oxydol is recommended.

5.2 Applying Power

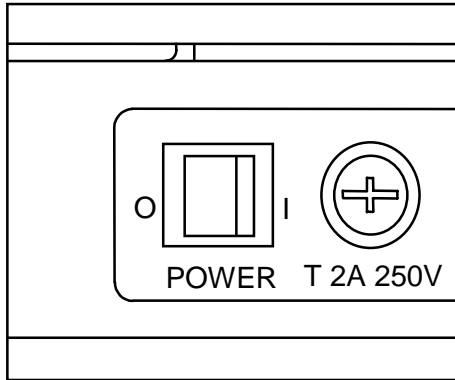

- (1) Confirm that the power is 'OFF' (○).

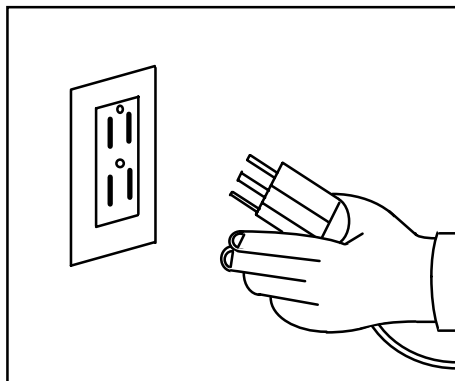

- (2) Insert the power cord into the instrument's power plug connector. Then insert the plug into a general-purpose outlet.



Always make sure that the cable is grounded.

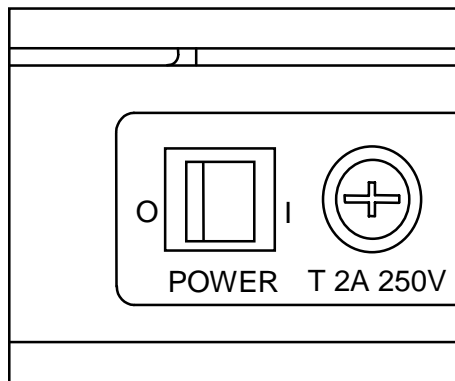

- (3) Turn the power switch 'ON' (|).

5.3 Standby

When the power is turned on, the screen as shown below appears on the LCD monitor, which is ready to take measurements.

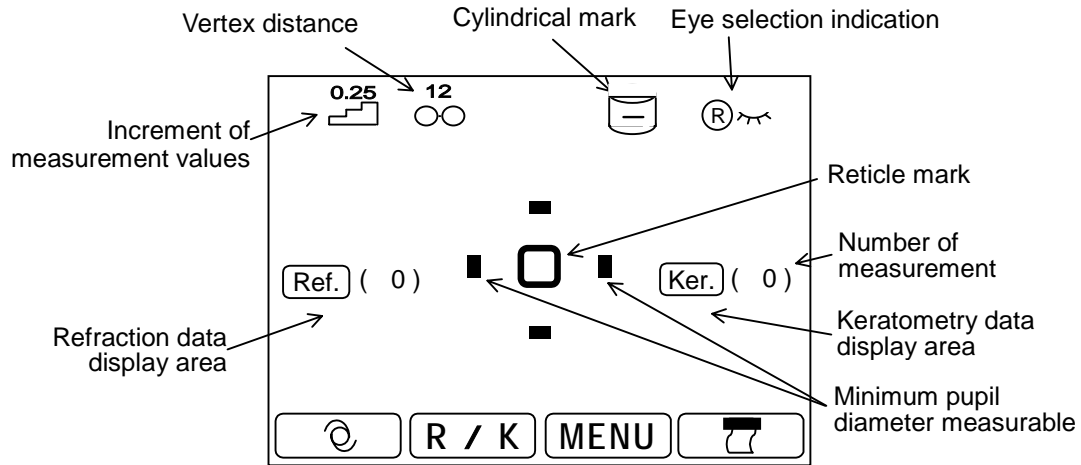

Icon Description

(Normal measurement)

Icon	Description
	Indicates increment of refraction data.
	Indicates corneal vertex distance. Selection is available among 0, 10, 12, 13.5 and 15mm.
	Indicates a mark for a cylindrical value.
	Indicates an eye currently measured.
	Refractive measurement result is displayed in this area. Indicated values are S, C, and A.
	Keratometry result is displayed in this area. Indicated values are R1, R2, and A. K1, K2 and KC can be also indicated when the setting of KERATO in the menu screen is changed.
	Shifts to IOL measurement mode.
	Measurement mode is switched. There are four measurement modes: Ref/Kerato continuous measurement, Ref single measurement, Kerato single measurement, and measurement corneal periphery.
	Shifts to MENU screen.
	Displays the measurement result on the screen and prints it out.

5.4 Switch Function

Operating switches below a LCD monitor correspond to the icons displayed on the bottom of the screen. For normal measurement, each icon functions as below.

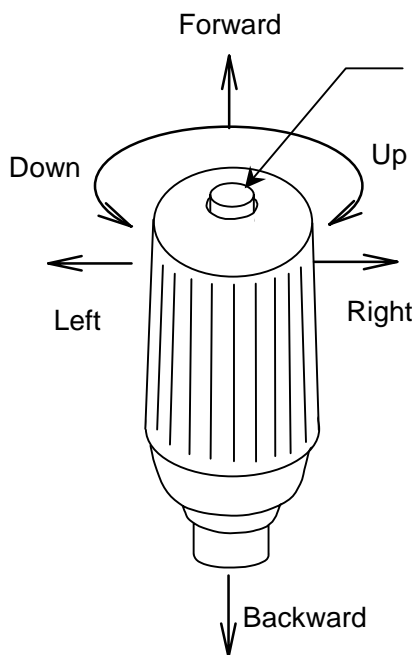
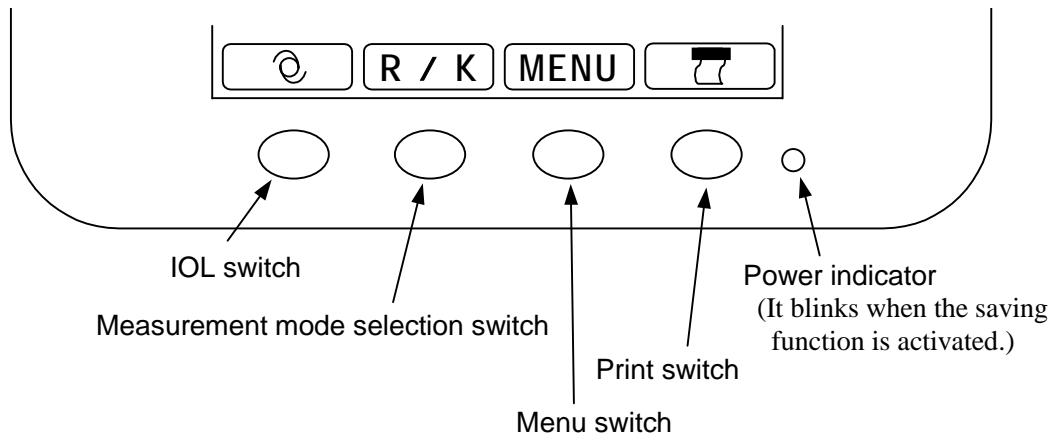

Measurement start switch: starts the measurement.

Operation of Joystick

- Forward: the body moves toward an examinee.
- Backward: the body moves toward an operator.
- Right/Left: the body moves to the right or left respectively.
- The measurement unit moves up when the joystick is rotated to the right, and moves down when rotated to the left.

6. Measurement

6.1 Measurement Flow

- (1) Rotate an anti-sliding lock clockwise to release it.
- (2) Have the examinee place his/her chin on the chin rest and his/her forehead against the head rest. Then, have him/her see a target.



NOTE Uncomfortable posture may cause fatigue to the examinee during measurement. Vertically adjust the optical table or the chair to avoid that.

- (3) Check from the side and adjust the chin rest so that the examinee's eye level is in line with the eye mark.
- (4) When the eye appears on LCD monitor, carry out alignment for correct measurement.



NOTE Refer to '6.2 Alignment' for detail procedure.

- (5) Press the measurement start switch when the alignment mark reaches a center of the reticle mark, and take measurement.



NOTE KW-2000 incorporates a high-speed continuous measurement function. To use the function, set DAT CLEARS (S) for OFF in MENU screen and keep pressing the measurement start switch during measurement.

6.2 Alignment

- (1) Operate a joystick to bring a center of the subject eye onto a reticle mark. When the subject eye is focused on, a kerato ring appears.

 **NOTE** If the eyelid is over the kerato ring, urge the examinee to open the eye bigger.

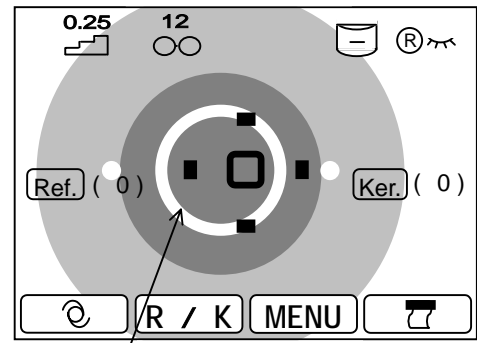

Kerato ring

- (2) Keeping the reticle mark in the center of the subject eye, try to focus the subject eye, and then, an alignment mark (+) will appear. Then, operate the joystick to bring the alignment mark (+) into the center of the reticle mark.

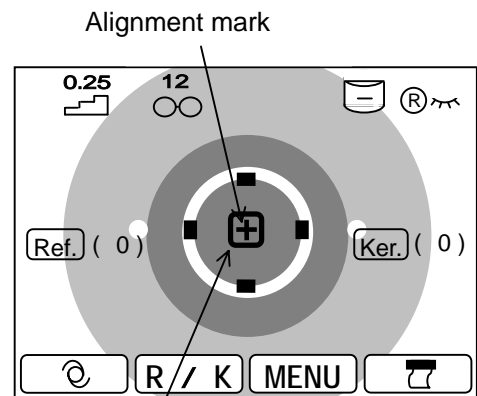

Reticle mark

- (3) Keeping the alignment mark (+) in the center of the reticle mark, focus on the subject eye and press the measurement start switch.

(For auto measurement, measurement will automatically start once the focus on the eye is achieved.)

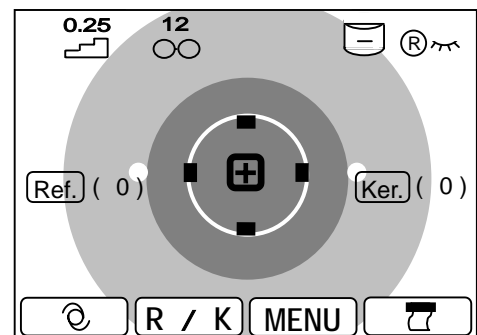

When focus is achieved, the kerato ring will become the thinnest.

6.3 Measurement Results

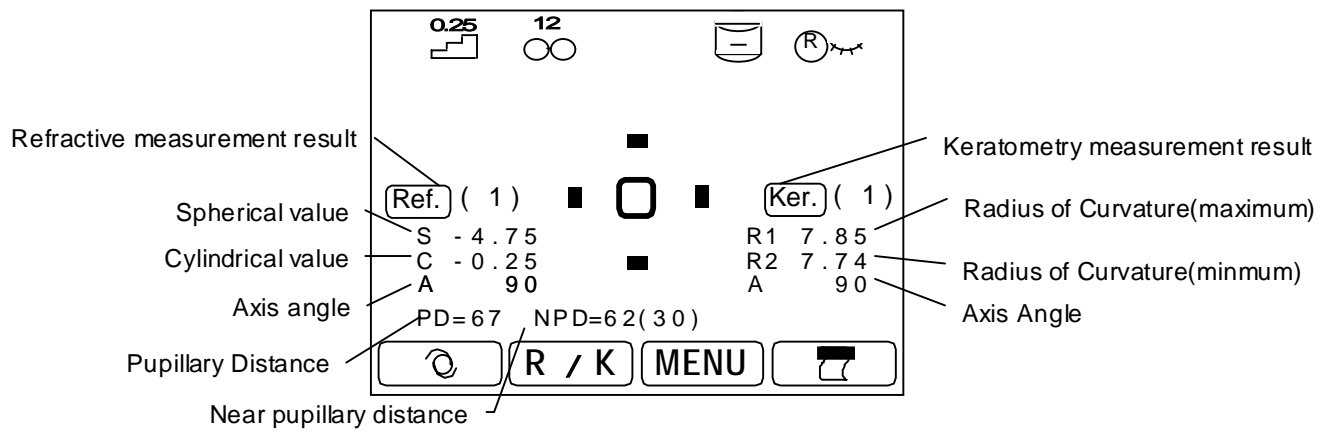

PC result is indicated after both right and left eyes are measured. The order of the eye to be measured is not important.

NPD is indicated when some value is set in 'W-D (cm)' of menu screen only.

6.4 Print Out

Normally you can print out the measurement result by pressing PRINT switch after the measurement.
(The icon of PRINT switch in the monitor turns into blue during printing.)

A maximum of ten data is recorded for each eye and the most reliable among them is indicated as an optimum value. The optimum value is indicated when each eye is measured over three times only.

The printout format, ALL, ECONO and OFF, can be set on the MENU screen.

- * ALL : prints out a maximum of ten refractive data for each eye.
Optimum values only are printed out for the others except for the refractive data.
- * ECONO : prints out only optimum values of all measurement data.
- * OFF : prints out no data.

Regardless of the setting of the printout format, the measurement data stored in memory will be cleared when the measurement start switch is pressed following the PRINT switch.

Sample printout when PRINT FORM is set for ALL

Sample printout when PRINT FORM is set for

```

No. 00001
NAME
2002 11 20 14:29
VD=12
<R> SPH CYL AX
- 4.75 0.00
- 4.75 0.00
- 4.75 0.00
-----
- 4.75 0.00
<R> mm D AX
R1 7.59 44.50 120
R2 7.57 44.50 30
AVE 7.58 44.50
CYL 0.00

<L> SPH CYL AX
- 4.50 -0.75 90
- 4.50 -0.75 90
- 4.50 -0.75 89
-----
- 4.50 -0.75 90
<L> mm D AX
R1 7.59 44.50 120
R2 7.57 44.50 30
AVE 7.58 44.50
CYL 0.00

PD = 64
MODEL KW-2000(V1.00)

```

Message area

You can print out registered characters in the range of 22 characters/line x 2 in the message area.
For registration, refer to '6.7.2 Option Function: I. Message Input Function'.

6.5 Kerato-Peripheral Measurement

KW-2000 incorporates a function to measure not only a center but also peripheries of a cornea.

Operation

- Press a measurement mode selection switch to switch over to P.K. mode.
P.K. measurement screen will appear and a 'measurement guiding mark' which indicates the measurement position will appear on the top of the screen.

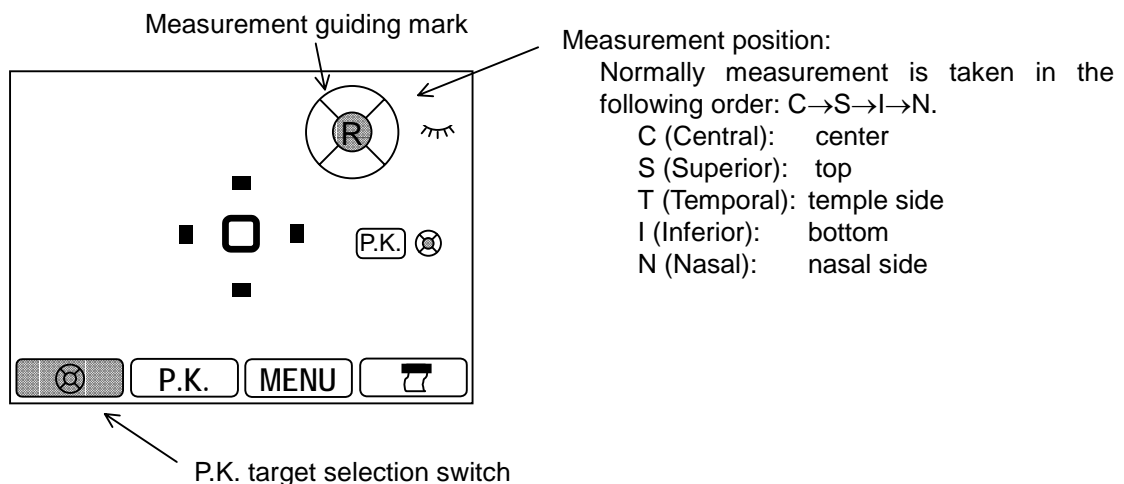

NOTE **Measurement Guiding Mark**
A measurement guiding mark changes its color and state to signal the measurement position and the end of measurement. Each color and state means as follows.

No color:	where have not been measured yet.
Blue :	where is going to be measured.
Light blue:	where measurement is complete.

- Measure the center following the kerato measurement procedure.
When the measurement is complete, the center of the measurement guiding mark changes from blue to light blue, and the next measurement position becomes blue.

NOTE Always start to measure from the center. However, it is not necessary when the center is already measured in R/K mode or Kerato mode.

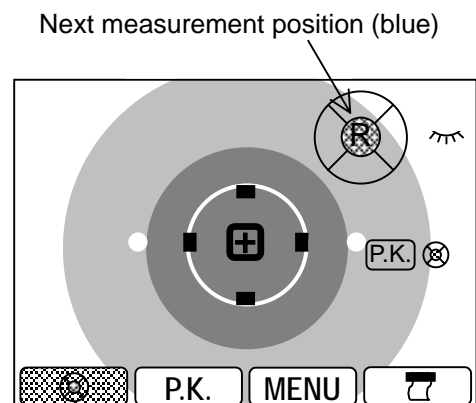

- (3) Measure the corneal periphery.
 Have the examinee look at the fixation target that is illuminating. A measurement position in the guiding mark is indicated in blue. Carry out alignment and press the measurement switch.
 When the measurement is completed, the guiding mark changes blue to light blue and the next measurement position becomes blue.

NOTE For peripheral measurement, align the alignment mark to the center of the reticle mark, not to the center of pupil.

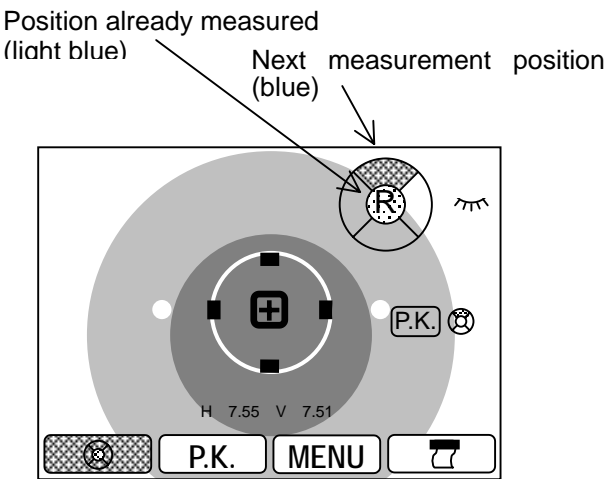

- (4) Complete the peripheral measurement for all four positions. When it is completed, all positions of the measurement guiding mark will turn to light blue.
 Proceed to measure the other eye according to the procedure above.

NOTE

- When you wish to measure some position again, use P.K. target selection switch to move the cursor to the position you wish to measure.
- When you can not take any data, or you do not need all data of the peripheral measurement, you can skip some position using P.K. target selection switch. In such a case, the result of the position measured only is displayed. The center, however, must be measured all the time.

Printout Sample of P.K. Measurement

<R>	mm	D	AX
R1	7.59	44.50	120
R2	7.57	44.50	107
AVE	7.58	44.50	
CYL		0.00	

S	7.84
V	7.51
T 7.66 - H	7.55 - N 7.71
I	7.84

e	V	H	AVE
	0.554	0.396	0.475

<L>	mm	D
R1	7.59	44.50

Peripheral Measurement Result

Data of Corneal Center only
 When R/K or Kerato measurement is also taken, only optimum values are printed.

Average of Vertical and Horizontal Eccentricities

Horizontal Eccentricity

Vertical Eccentricity

6.6 IOL Measurement

KW-2000 has the function to measure the IOL (intraocular lens) implanted eye.

When measuring the IOL implanted eye, press IOL switch on the front panel of the body to activate the function.

At this time, the icon for IOL switch as well as S, C, and A on the LCD monitor turns to purple.

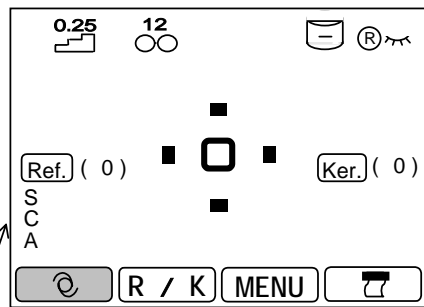

【IOL mode measurement screen】

In IOL measurement mode, the IOL switch icon, S, C, and A change to purple.

No.	00001		
NAME	2002 08 20 14:29		
VD	=12		
<R>	SPH	CYL	AX
IOL	-4.75	0.00	60
IOL	-4.50	-0.25	60
IOL	-4.50	-0.25	131

【Printout sample】

Measurement results of IOL measurement mode are marked with 'IOL' on the left of each data.

IOL measurement mode will be cancelled:

- when IOL switch is pressed again;
- when the measurement mode is switched to either K mode or P.K. mode;
- when the data is printed out;
- when the eye to be measured is switched from right to left or vice versa;
- when the power is turned off.



NOTE If IOL mode is not set when IOL implanted eye is measured, error message may appear and measurement may fail.

6.7 Menu Screen Setting

Standard measurement mode is preset to be ready to use. However, you can easily alter the setting if necessary.

To enter the menu screen, press a menu switch below the LCD monitor.

【Menu Screen】

START	MANUAL	AUTO3	AUTO5	SAVE(min.)	OFF	3	5	10
REF	NORMAL	QUICK(3)		BUZZER	HIGH	LOW	OFF	
STEP	0.25	0.12		DATA CLEAR(s)	OFF	1	2	3
VD(mm)	0	10	12	13.5	15			
CYL	-	+	±	OPTION	MESSAGE	No.	RS232C	
KERATO	RADIUS	DIOPT		DATE FORM	YMD	DMY	MDY	
PRINT FORM	ALL	ECONO	OFF	DATE	2002/11/20			
PRINT OUT	TOP	BOTTOM		TIME	14:29:22			
DATA SCREEN	ON	OFF						
W-D(cm)	OFF	30	35	40	45			
TARGET LIGHT	BRIGHT	NORMAL	DARK					
SCREEN ADJ.								





the First Screen

the Second Screen

Change of Switch Function

Each switch function will change when you enter the menu screen.

Follow the icons indicated on the bottom of the screen, which corresponds to each switch (see below).

- ◆  The cursor moves downward on each setting menu.
- ◆  The cursor moves upward on each setting menu.
- ◆  Selection of the item in each setting menu. The cursor moves to the right.
- ◆  Completion of the setting and return to the measurement screen.

6.7.1 Each Item Description

【The First Screen】

- **START** Selects how to start measurement. Refer to '6.8 Auto Start Function' for detail.
 - MANUAL:** Measurement is taken every time the measurement switch is pressed.
 - AUTO 3 :** Measurement is automatically started when the measurement requirements are met. Three measurements are continuously taken for each eye and automatically printed out when the measurement is over.
 - AUTO 5 :** Measurement is automatically started when the measurement requirements are met. Five measurements are continuously taken for each eye and automatically printed out when the measurement is over.

- **REF** Selects refractive measurement manner.
 - NORMAL:** One measurement when the measurement start switch is pressed once.
 - QUICK :** A set number of measurements are continuously taken when the measurement start switch is pressed once. A maximum of ten measurements is available.
A target moves only for the first measurement for the continuous measurement. The target does not move after the second measurement.



The setting of this item is invalid when START is set for either "AUTO 3" or " AUTO 5".

- **STEP** Selects the increment for refractive measurement.

- **VD(mm)** Selects corneal vertex distance.

- **CYL** Selects the sign for cylindrical value.

- **KERATO** Selects the display unit for kerato measurement.
 - RADIUS :** a radius of corneal curvature
 - DIOPT :** a corneal refractive power

- **PRINT FORM** Select printout format. Refer to '6.4 Print Out' for detail.
 - ALL :** prints all data. (A maximum of ten data for each eye.)
 - ECONO :** prints the optimal values only.
 - OFF :** no printouts.

- **PRINT OUT** Selects direction of data printed out.

- **DATA SCREEN** Measurement results stored in memory are displayed on the screen. Refer to '6.8 Data Screen Function' for detail.
 - ON : All measurement results are displayed on the screen.
 - OFF : No measurement results are displayed on the screen.



- **W-D(cm)** Sets near work distance. When measurement is taken with this item set, a near pupillary distance is automatically computed and indicated on the screen as well as on the printout.



 This function is activated only when refractive measurement is taken.

- **TARGET LIGHT** Sets the brightness of the target.
 - BRIGHT : for brightening the target.
 - NORMAL : normal setting.
 - DARK : for darkening the target.

- **SCREEN ADJ.** Brightness of a LCD monitor is adjusted or altered.

 Switch functions will change in this item as below.

-  (K·R>R>K>P.K.switch): makes the monitor brighter.
-  (IOL switch) : makes the monitor darker.

When you finish adjusting or altering, move the cursor to any other items except for "SCREEN ADJ.", using  or  switch.

【The Second Screen】

- **SAVE (min.)** Selects switchover time (in minute) to activate power saving function.

- **BUZZER** Sets volume of buzzer at measurement.
 - HIGH : turns volume up.
 - LOW : turns volume down.
 - OFF : no buzzer.

- **DATA CLEAR(S)** Sets the condition for clearing measurement data. (The unit is second.)
 The measurement data can be cleared from memory when the measurement start switch is pressed for the time set.
 If this item is set for OFF, the measurement data is not cleared and continuous measurement is taken when the measurement start switch is pressed.

- **OPTION** Selects and sets optional functions. Refer to '6.7.2 Optional Function' for detail.
 MESSAGE: shifts to the screen for registering message.
 No. : shifts to the screen for setting examinee's number.
 RS232C : shifts to the screen to set RS232C transmission parameters.

- **DATE FORM** Selects display form of date.
 YMD: year/month/ date
 DMY: date/year/month
 MDY: month/date/year



- **DATE** Sets and corrects date.

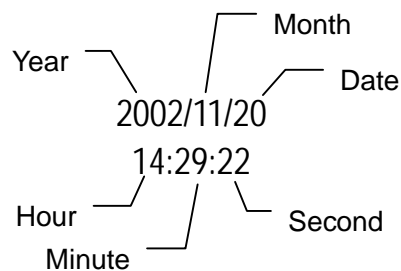

- **TIME** Sets and corrects time.

If you wish to correct date or time, move the cursor to the number you wish to change.



 **NOTE** Switch Functions will change in this item as below.

-  : Increases the number.
-  : Decreases the number.

When you complete all settings or changes, press  or  switch to move the cursor to any items other than TIME. Then, press  switch to return the measurement mode.

6.7.2 Optional Functions

When you select the function you wish to set in 'OPTION' of Menu screen, you can enter each option screen.

【Each Option Screen and Description】

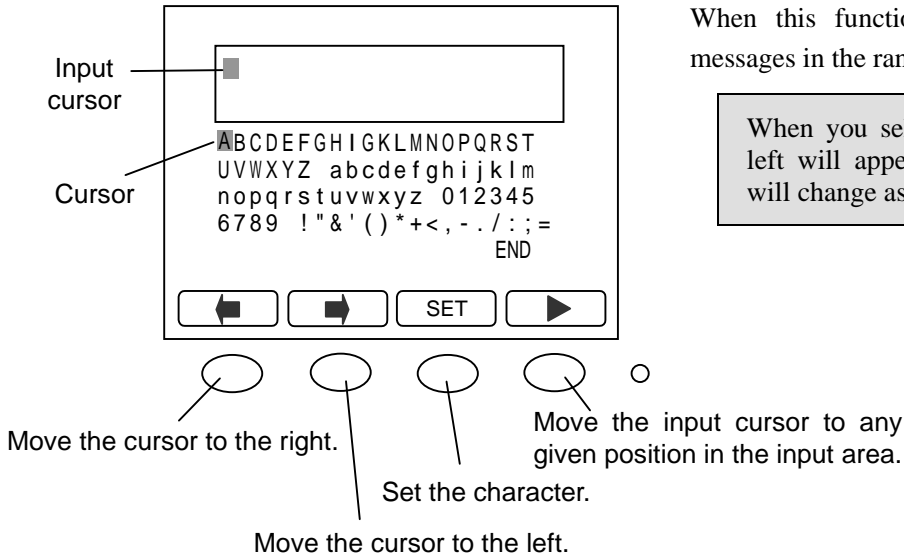

I. Message Input Function



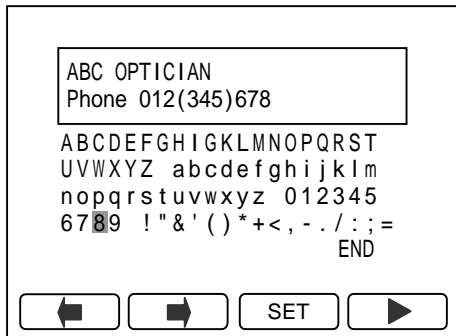

When this function, you can print out registered messages in the range of 22 characters/line x 2 lines.

When you select this menu, the screen on the left will appear, and function of each switch will change as shown on the left.



- (1) With  or  switch, select the character you wish to input and confirm with  switch.

Then, the input cursor moves to the next input area to be ready for the next input.

 **NOTE** When you need to change the character already inputted, press  switch to move the input cursor to the character you wish to input. Then, you can write over.

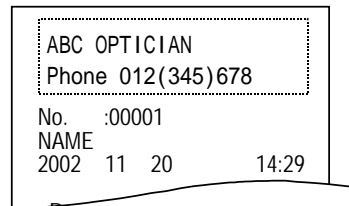

[Print out sample]

- (2) When the setting is completed, move the input cursor to 'END' and press  switch to go back to the menu screen.

II. No. Function

You can set or change the examinee's number, and select whether the number is displayed on the screen and whether the number is printed out.

When you select this menu, the screen below will appear and function of each switch will change as following.

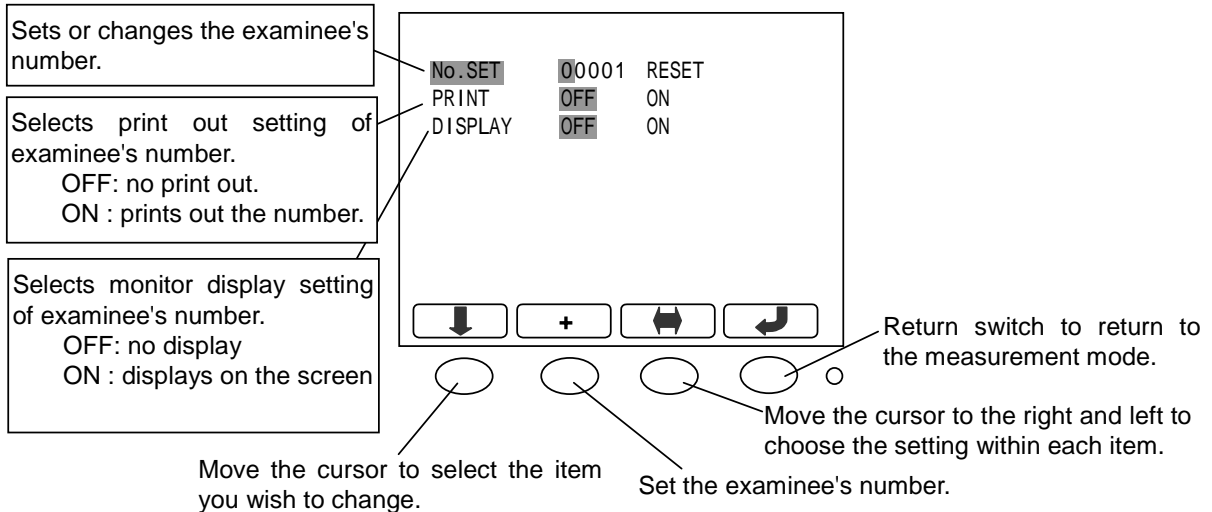

Resetting Examinee's Number
NOTE When you wish to reset the examinee's number, move the cursor to RESET of No.SET and press the measurement start switch.

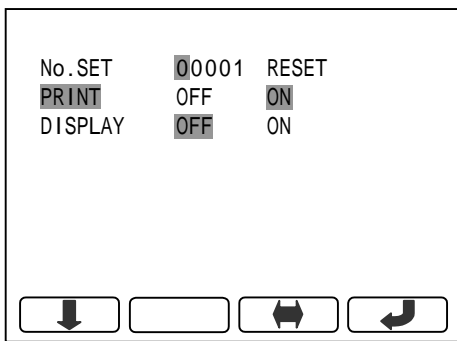

- (1) Move the cursor to the item you wish to set/change with switch and execute with switch.
- (2) When you complete the setting, press switch to go back to the Menu screen

【Screen when DISPLAY is set to ON】

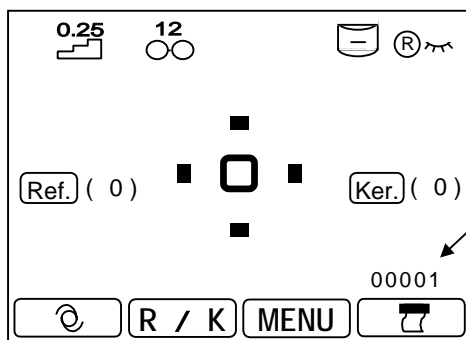

【Print out when PRINT is set to ON】

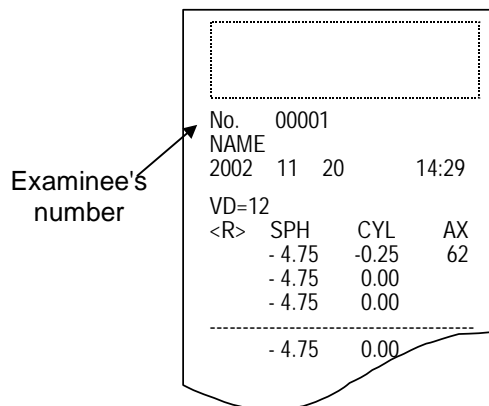

III. RS232C Setting Function

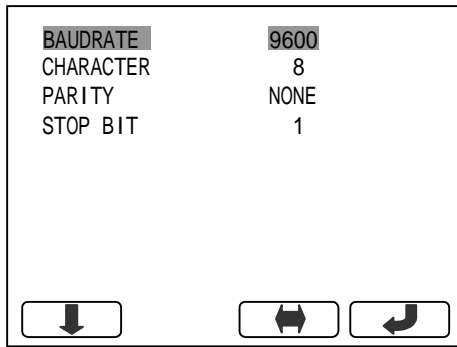

With this function, you can send the measurement data to an external computer through an interface. The data is sent using ASCII CODE.

When you select this menu, the screen on the left will appear and function of each switch will change as shown.

Change the setting of the item selected. The display changes every time the switch is pressed. Press the return switch at any given setting.

【Each Item Description】

1. BAUDRATE : selection of a transmission rate for a serial interface.

BAUDRATE option	Standard setting
38400bps	
19200bps	
9600bps	
4800bps	
2400bps	

2. CHARACTER : selection of data bit

CHARACTER option	Standard setting
8	
7	

3. PARITY : selection of transmission data check.

PARITY option	Standard setting
EVEN	
ODD	
NONE	

4. STOP BIT : selection of code to terminate data output.

STOP BIT option	Standard setting
2	
1	

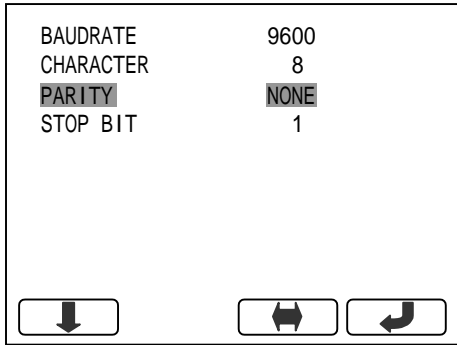

- (1) Move the cursor to the item you wish to set/change with switch and execute with switch.
- (2) When the setting is completed, press switch to go back to the menu screen.

【Connection method】

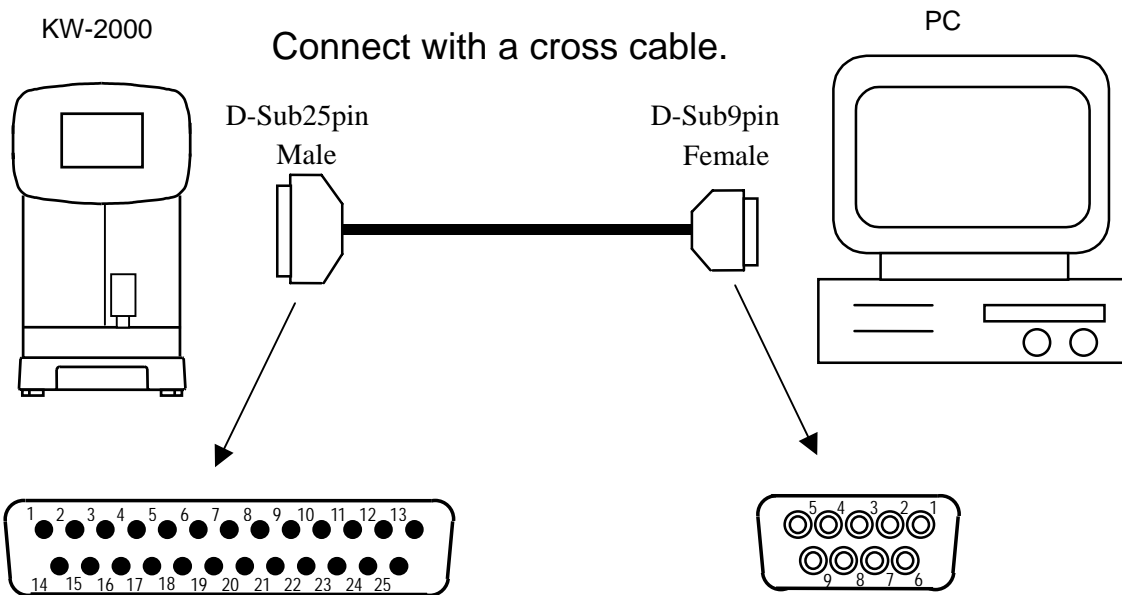

■ **Connection**

D-Sub25pin		D-Sub9pin	
TXD	2	2	RXD
RXD	3	3	TXD
DSR	6	4	DTR
SG (GND)	7	5	SG (GND)
DTR	20	6	DSR

NOTE Use a shield type of cable for the connection cable in order to protect the output data from noise.

If you have any inquiries about changes in transmission parameters and/or detail connections, please direct them to the relevant agent or distributor.

6.8 Auto Start Function

KW-2000 incorporates Auto Start Function.

This function starts measuring automatically when alignment meets the measurement requirement, and also prints out automatically when the measurement of both eyes completes.



When Auto Start Function is activated, measurement is always taken according to the setting of START regardless of REF setting in the menu screen.

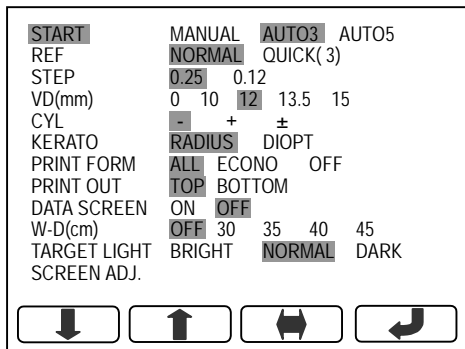

(1) When you wish to measure with auto start function, select 'AUTO3' or 'AUTO5' in 'START' of the Menu screen

(2) Then, press  switch to go back to the measurement screen.

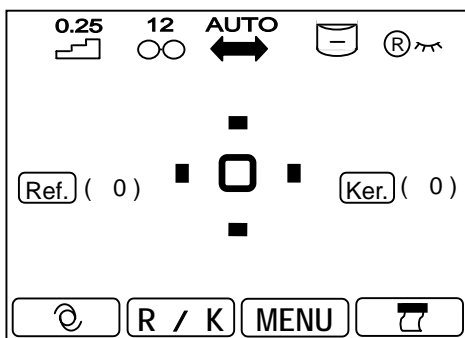

(3) Auto Start mode is activated when 'AUTO' and arrows below 'AUTO' appear on the top of the screen (see on the left).

You can start measurement from either right or left eye.

(4) Carry out alignment. Measurement will automatically start when alignment is achieved.

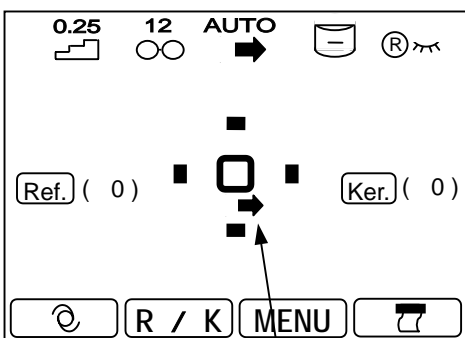

The arrow to urge the shift flashes.



For alignment, refer to '6.2 Alignment'.

When the measurement of one eye finishes, an arrow on either left or right side you have measured will disappear. In addition, an arrow to urge the shift to the other eye will appear and flash in the center of the screen.



The operator shifts the body of the unit to the eye which has not measured according to the arrow.
When the body is shifted, the arrow flashing in the center of the screen will disappear.

(5) Measure the other eye in the same manner.

(6) After both eyes are measured, the arrow will disappear and the measurement result will be automatically printed out.



The data printed out depends on the setting of print out format.

NOTE When the data screen is set for 'ON', the screen changes to display all optimal values after both eyes are measured.

(7) If you wish to continue to measure with auto start function, realignment is necessary.



When you wish to cancel auto start function, change the setting of 'START' back to 'MANUAL' in the menu screen.

6.9 Data Screen Function

Data screen function allows you to check measurement results saved in the memory on the screen.

Displaying measurement data on the screen

START	MANUAL	AUTO3	AUTO5
REF	NORMAL	QUICK(3)	
STEP	0.25	0.12	
VD(mm)	0	10	12 13.5 15
CYL	-	+	±
KERATO	RADIUS	DIOPT	
PRINT FORM	ALL	ECONO	OFF
PRINT OUT	TOP	BOTTOM	
DATA SCREEN	ON	OFF	
W-D(cm)	OFF	30	35 40 45
TARGET LIGHT	BRIGHT	NORMAL	DARK
SCREEN ADJ.			

↓ ↑ ↔ ↶

- (1) Select 'ON' in 'DATA SCREEN' of the Menu screen.



When 'DATA SCREEN' is 'ON', the setting of 'PRINT FORM' is invalid (see '6.7.1 Each Item Description').

** RIGHT**

R) SPH	CYL	AX	mm	D	AX
-4.75	-0.25	62	R1) 7.59	44.50	120
-4.75	0.00		R2) 7.57	44.50	107
-4.75	0.00		AVE 7.58	44.50	
-4.75	0.00		CYL	0.00	
-4.75	0.00				
-4.75	-0.25	62	S 7.58	T 7.66	
-4.75	0.00		V 7.51	H 7.55	
-4.75	0.00		I 7.84	N 7.71	
-4.75	0.00				
-4.75	0.00		e(ver)	0.554	
-4.75	0.00		e(hol)	0.396	
-4.75	0.00		e(ave)	0.475	

↻ PRESS START SW -> RETURN ↻

- (2) After the measurement, press  switch, and the data screen will appear as shown on the left.



'I' mark will be indicated on the left side of each refractive data as shown below when you measure with IOL measurement mode.

Example: SPH CYL AX
I -4.75 -0.25 62

- (3) Displaying the data on the screen, press  switch to change over the display as below.

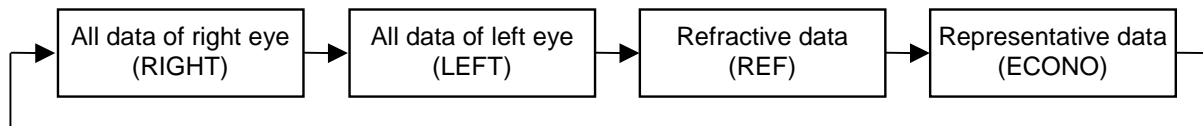

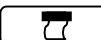
- (4) When you wish to print out the measurement data, press  switch again.

- (5) Press the measurement start switch to go back to the measurement screen.

6.10 Power Saving Function

Power saving function will start operating when switch operation is suspended with the power on.
(The switchover time (in minute) can be selected at 'SAVE' on the mode selection screen.)

To return to the measurement mode, press any switch (any switch on the front panel or the measurement start switch).

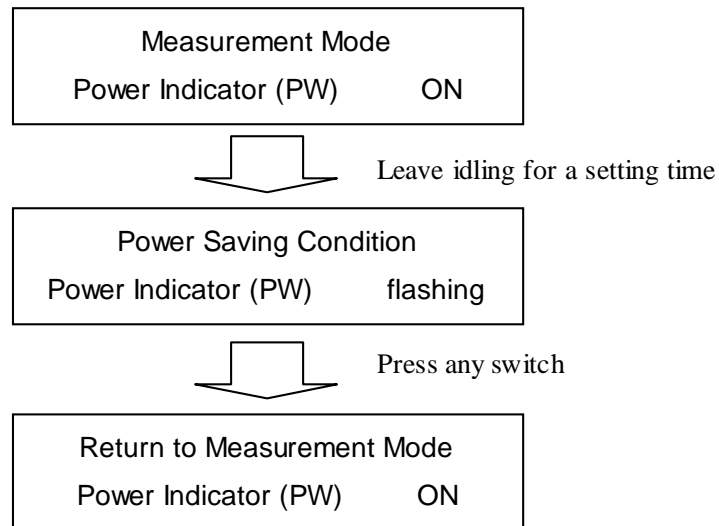

6.11 Output Terminal

Video Terminal

This terminal outputs an NTSC video signal.

If you connect an external monitor such as a portable TV or similar unit to KW-2000 with pin plug (video) cable, you can observe and check the same image that appears on the internal monitor screen of KW-2000 simultaneously.

7. Tips for Effective Measurement

- (1) Do not allow external light to directly penetrate the room.
- (2) Fluctuation of values during measurement may occur if the examinee looks something other than the target. Urge the examinee to concentrate on the target set in front.
- (3) Talk to the examinee in a relaxed and friendly manner, so as to allay any fear or doubt they may have.
- (4) Inappropriate height of a chin rest or a chair will cause the examinee fatigue. Adjust the (optional) instrumental table to establish the most comfortable and convenient position for the examinee.
- (5) When the eyelash or eyelid interfere measurement, error will occur in measurement. Urge the examinee to keep his/her eye wide open.
- (6) Tear residue or eye mucus, etc. trapped on the corneal surface may cause measurement errors. Check the surface with LCD monitor, and if you see something moving when the examinee blinks, remove it before measurement.
- (7) When the pupil of the eye to be examined is smaller than the minimum pupil diameter measurable, correct measurement will be impossible. When the pupil is too small to take correct measurement, make the surroundings (room) or the target darker to allow the pupil to dilate as much as possible.
- (8) If the examinee's head moves during measurement, AXIS value will be adversely affected.

8. Error Messages

KW-2000 automatically evaluates measurement condition or result and indicates error messages if it is invalid. Error messages also appear when abnormality is detected in its operational system.

When any error message appears, always check the system with a supplied model eye. If it appears when no abnormality in system is detected, check the measured eye for eye disease or problem.

Message	Cause/Explanation	Corrective Action
RETRY	Failed to capture eye image because the examinee blinks or moves during measurement or the examined eye has an eye disease.	Realign precisely and take measurement again. Consult your dealer immediately if the message reappear. Do not try to repair by yourself.
SPH OVER	Exceeded spherical measurement range (-25D to +25D). (when VD = 0)	
CYL OVER	Exceeded cylindrical measurement range (0 to ± 10 D) .	
Motor fault.	Detected abnormality in motor control system.	Cut the power and turn it back on. Consult your dealer immediately if the message reappear.
EEPROM fault.	Failed to initialize.	Do not try to repair by yourself.
Printer head up lever.	Printer head is up.	Close the printer head.
Printer head heat over.	Printer head is overheated.	Cut the power and stop using until the head cools off. Consult your dealer immediately if the message reappear. Do not try to repair by yourself.
Printer cutter fault.	A paper jam occurred at a printer cutter or the printer cutter did not move for some reason.	Always cut the power , and check on the paper jam. If the message reappears without the paper jam, consult your dealer immediately. Do not try to repair by yourself.
Paper empty.	No printer paper.	Set the printer paper. See '11.1 Reloading Printer Paper.'

9. Contact Lens: Base Curve Measurement

You can measure a base curve of a hard contact lens with KW-2000.

To do so, attach a contact lens onto a contact lens holder of the model eye as following.

- (1) Put a small amount of water on a concave side of the contact lens holder.
- (2) Place the contact lens so that its convex side faces the holder.

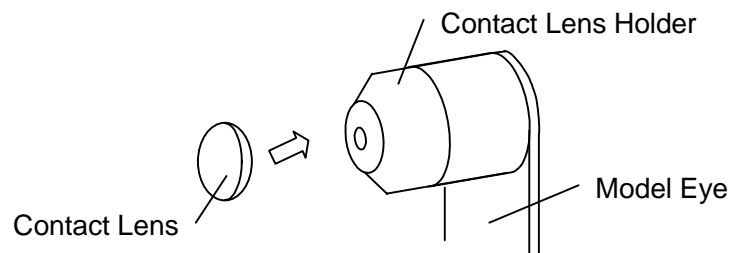

- (3) Confirm the contact lens is firmly adhered to the holder and does not slip down, set the model eye unit to measure.

10. Troubleshooting

If there are any malfunction found, refer to the table below to take appropriate measures.

 CAUTION	Never disassemble, modify or repair the instrument. Personal injury may result from electric shock.
--	--

Symptom	Causes and Measures
The monitor and power indicator are not turned on.	<ul style="list-style-type: none"> • The power cord may be not properly connected. Make sure to connect it securely. • Fuse may be blown. If so, replace it to the new one.
Fuse is blown when the power switch is turned on.	<ul style="list-style-type: none"> • Contact your local distributor immediately.
The monitor display suddenly disappears.	<ul style="list-style-type: none"> • The saving function may be activated. Press any switch to deactivate the saving function.
The main body can not be moved in a horizontal direction.	<ul style="list-style-type: none"> • Anti-sliding lock may be locked. Unscrew the lock under the base.
The moving parts such as a joystick are not moving appropriately.	<ul style="list-style-type: none"> • Do not force to move the part. Contact your local distributor or service person.
The apparatus does not print out.	<ul style="list-style-type: none"> • Check the papers being set. Reload them if the papers are out. • PRINT FORM in the MENU screen may be set for OFF. Change the setting.
The printer papers come out but no printing.	<ul style="list-style-type: none"> • The printer paper may be set in a wrong direction. Set the paper properly.
The date setting becomes inaccurate.	<ul style="list-style-type: none"> • The battery inside the apparatus may be dead. Keep the power on for 24 hours to recharge it.

Contact your local distributor immediately if the situation does not improve even when the measures mentioned above are taken.

11. Storage and Maintenance

11.1 Reloading Printer Paper

- 1) Remove a printer cover and take a printer paper shaft out.
- 2) Lift a printer cutter part and pull up a head-up lever.

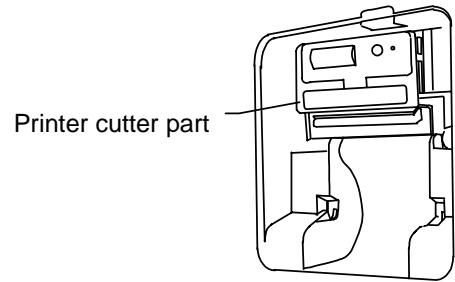

- 3) Set a roll of printer paper, paying attention to direction of the paper rolled up.

 The loose end of the paper should be drawn forward in a counterclockwise direction.

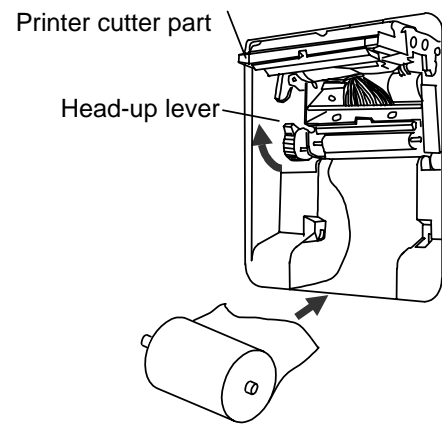

- 4) Insert the loose end of the paper behind a rubber roller. Press print switch more than one second to feed the paper out.

 Never pull the paper out. Pulling the paper may cause the paper output incorrectly or jammed.

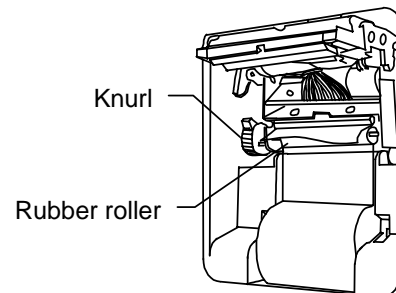

- 5) Draw the paper through the printer cutter slot and lower the head-up lever and the printer cutter back to the original positions.

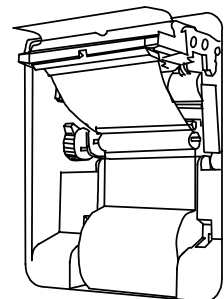

- 6) Draw the paper a cutter slot of a printer cover and reattach the printer cover to complete the procedure.

 Always use the specified printer paper only. The paper other than the specified one may cause a paper jam or fade in printing.

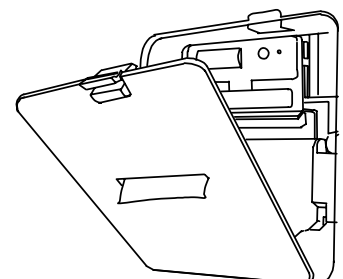

11.2 Fuse Replacement

 CAUTION	<p>When replacing a fuse, unplug the power cord from the unit before removing the fuse holder. You may be in danger of electric shock if you remove the fuse holder without unplugging the power cord.</p>
--	--

When a fuse is blown, remove a fuse holder at the side of a main unit for replacement. Pushing the fuse holder, rotate it in the direction of the arrow below and you can remove it.

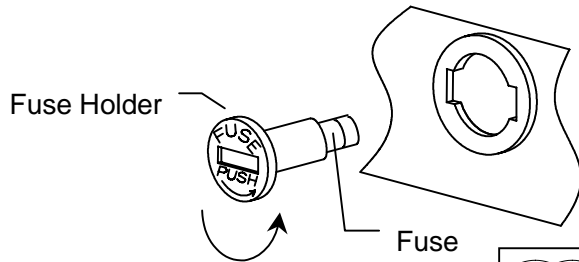

Rotate the holder counterclockwise.



Always use the specified fuse (T2A 250V).

NOTE

11.3 Storage

(1) Points to be checked for long-term storage

- Turn the power switch OFF.
- Remove the power cord from the outlet.
- Lower the optical unit to the bottom (original position).
- Secure the body with the anti-sliding screw lock.
- Put a dustproof cover on the optical unit.

(2) Notes on storage environment

Avoid storage under the following conditions.

- Where dust accumulates.
- Where water may get on the unit.
- Where temperature and humidity are high.
- Where sunlight directly contacts.
- Unstable and/or high place.

Always follow the environment conditions below for storage.

Environmental Conditions	
Temperature	Relative Humidity
- 10 ~ + 60	below 70%



Always check above whenever you store or do not use KW-2000 for a long time. When you reuse the instrument after long-term storage, operate according to instruction in '5. Preparation.'

11.4 Confirmation of Measurement Accuracy

It is extremely important to check operation and accuracy of the instrument using a supplied model eye. We recommend you to check accuracy periodically.

When the measurement result of the model eye falls anywhere within the tolerance listed below, measurement should be considered reliable and accurate. When the result exceeds the tolerance, contact your dealer immediately.

Model Eye Data		
SPH	CYL	R
Indicated value ± 0.25	0 ± 0.25	Indicated value ± 0.03

Precise value of the supplied model eye is indicated on the model eye stand (VD =12).

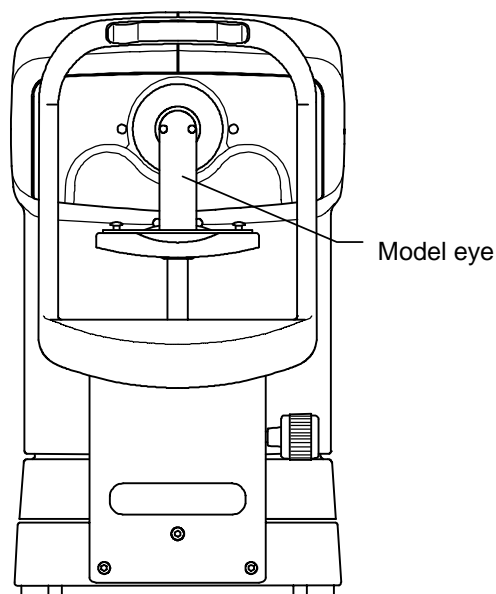

Note for setting of model eye

NOTE

- Remove a contact lens holder cap and set a model eye, checking it is not inclined in any directions.
When the model eye is inclined, CYL value can not be correctly measured.
- Set the model eye at the position where an alignment mark is located inside a reticle mark and good focusing is achieved.
- When conditions above have been satisfied, proceed to measurement.

11.5 Periodical Inspection and Maintenance

To prevent malfunction and accidents and maintain the performance and reliability of the product, it is recommended to request your distributor for the periodical inspection and maintenance once a year.

The periodical inspection and maintenance include inspection of the function and performance of the product, and cleaning, adjustment and replacement of consumable parts if necessary.

12. Specifications

Refractive Measurement Range	Sphere (S)	-25 ~ +25D	(step: 0.12/0.25D)
	Cylinder (C)	0 ~ ± 10D	(step: 0.12/0.25D)
	Axis (A)	0 ~ 180°	(step: 1°)
Measurement Accuracy	Sphere	between - 10 ~ + 10D : ± 0.25D	beyond ± 10 : ± 0.5D
	Cylinder	± 0.25D	
Keratometry Measurement Range	Radius of Corneal Curvature	5.0 ~ 10.0mm	(step: 0.01mm)
	Corneal Refraction	33.75 ~ 67.5D	(step: 0.12/0.25D) (a refractive index of cornea: n = 1.3375)
	Cylinder	0 ~ ± 9D	
	Axis	0 ~ 180°	(step: 1°)
Vertex Distance	0, 10, 12, 13.5, 15mm		
Minimum Pupil Diameter	2.3 mm		
PD Measurement	Measurement range	85mm	(step: 1mm)
Measurement Time	Refractive measurement	approx. 0.07 sec.	
	Keratometry measurement	approx. 0.07 sec.	
Printer	Thermal line printer with automatic cutter (paper width 57mm)		
Internal Monitor	5.6 inch LCD monitor (color)		
Shifting Range for Sliding Body	back/forth ± 17mm	right/left ± 43mm	up/down ± 17.5 mm
Vertical Adj. Range for Chin Rest	± 30mm		
Dimensions	245 mm (W) × 422 mm (D) × 429 mm (H)		
Weight	approx. 15kg		
Data Output	RS232C interface Video Terminal		
Power Source	100 ~ 240V 50 / 60Hz		
Consumption	80VA		
Power Saving Function	OFF , 3 , 5 , 10min. (switchable)		

Production Year

The second digit of serial number represents a production year of each instrument. The serial number is indicated on the nameplate that is on the side of body. See below.

9 **2** A G 0 1 0 3

This number is the last digit of the production year.
In this example, the production year is 2002.

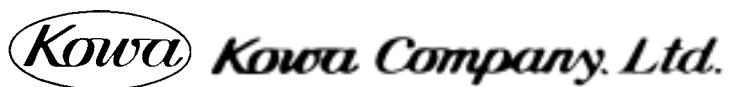

Life Science Division

No.4-14, 3-chome, Nihonbashi-Honcho, Chuo-ku, Tokyo 103-8433, Japan
Phone: 81(3) 3279-7312
Facsimile: 81(3) 3245-1109

Kowa Optimed, Inc.

20001 So. Vermont Ave. Torrance,
CA 90502, U.S.A.
Phone: 1(310) 327-1913
Facsimile: 1(310) 327-4177

Manufacturer

RyuSyô Industrial Co., Ltd.
Kagawa Factory
958 Ikeuchi, Konan-cho,
Kagawa-gun, Kagawa 761-1494 JAPAN



EU Representative

Kowa Europe GmbH

Immermannstrasse 65A 40210
Dusseldorf F.R. Germany
Phone:19 (211) 35-3444/45/46
Facsimile: 49(211) 161952

Free Manuals Download Website

<http://myh66.com>

<http://usermanuals.us>

<http://www.somanuals.com>

<http://www.4manuals.cc>

<http://www.manual-lib.com>

<http://www.404manual.com>

<http://www.luxmanual.com>

<http://aubethermostatmanual.com>

Golf course search by state

<http://golfingnear.com>

Email search by domain

<http://emailbydomain.com>

Auto manuals search

<http://auto.somanuals.com>

TV manuals search

<http://tv.somanuals.com>