

Kramer Electronics, Ltd.

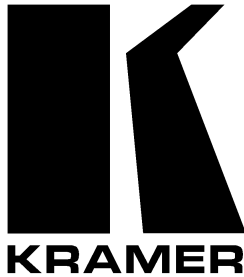

USER MANUAL

Models:

VS-1xl, RS-232 Remote Controller

RC-1Pxl / VS-1Pxl, Control Panel

Contents

1	Introduction	1
2	Getting Started	1
3	Your Remote Controller	2
4	Using Your Remote Controller	4
4.1	Setting the PROGRAM Dipswitches	4
4.1.1	Setting the PROGRAM Dipswitches on the VS-1xl (an example)	6
4.1.2	Changing the Group Number	7
4.1.3	Routing Video and/or Audio via the VS-1PxI Control Panel	7
4.2	Connecting the Remote Controller	8
4.2.1	Using a Null-modem Adapter or a One-to-One Connection	8
4.2.1.1	Connection using a Null-modem Adapter (Basic Principle)	8
4.2.1.2	Connection without a Null-modem Adapter (VS-88A, VS-88V, VP-81, and VP-43xl)	8
4.2.1.3	Connection using either a Flat Cable or a Null-modem Adapter (VS-1616A, VS-1616V, VS-1616AD, VS-1616SDI, VS-162V, and VS-162AV)	9
4.2.2	Connecting the VS-1xl RS-232 Remote Controller	9
4.2.3	Connecting the DB25 “To Switch Assembly” Connector	10
4.3	Operating Your Remote Controller	11
4.3.1	For Switchers in Groups 1, 4, 5, 6, 7, 9, 13, 14, 15, 16, 17 and 18	11
4.3.1.1	Example - Connecting a Group 18 Switcher (VS-1616)	11
4.3.1.2	Example - Connecting a Group 4 Switcher (VS-2042)	11
4.3.2	For Switchers in Group 2	12
4.3.2.1	Example - Connecting a Group 2 Switcher (VS-1202YC)	12
4.3.3	For Switchers VP-23, VP-24 or VP-25xl	14
4.3.3.1	Examples - Connecting a VP-23, VP-24 or VP-25xl Switcher	14
4.3.4	For Switchers with a Single Output	14
4.3.4.1	Examples - Connecting an SD-7308 or VS-120 Switcher	15
5	Technical Specifications	15

Figures

Figure 1:	VS-1xl RS-232 Remote Controller	2
Figure 2:	VS-1PxI Control Panel	3
Figure 3:	Setting the PROGRAM Dipswitches on the VS-1xl (an example)	6
Figure 4:	Connecting the VS-1xl RS-232 Remote Controller	9
Figure 5:	DB25 PINOUT	10
Figure 6:	Operating Your Remote Controller for Group 2	13
Figure 7:	Operating Your Remote Controller with Switchers VP-23, VP-24 or VP-25xl	16

Tables

Table 1: VS-1x1 Features	3
Table 2: Group Classifications	5
Table 3: Group Dipswitch Settings	6
Table 4: VS-1x1 RS-232 Remote Controller Technical Specifications	15
Table 5: VS-1Px1 Control Panel Technical Specifications	15

This addendum adds the following information to the user manual:

	Caution – No operator-serviceable parts inside unit.
	Warning – Use only the Kramer Electronics input power wall adapter that is provided with this unit ¹ .
	Warning – Disconnect power and unplug unit from wall before installing or removing device or servicing unit.

¹ For example: model number AD2512C, part number 2535-000251

1 Introduction

Dedication by Kramer Electronics since 1981, to the development and manufacture of high quality video/audio equipment, makes the Kramer line an integral part of the finest production and presentation facilities in the world. In recent years, Kramer has redesigned and upgraded most of the line, making the best even better! The Kramer line of professional video/audio electronics is one of the most versatile and complete available, and is a true leader in terms of quality, workmanship, price/performance ratio and innovation.

In addition to our high quality Kramer TOOLS and remote controllers, we also offer excellent distribution amplifiers, switchers and matrices, processors, interfaces and computer-related products.

Congratulations on purchasing your Kramer **VS-1x1 RS-232 Remote Controller** and/or **VS-1Px1 Control Panel**. These products are ideal for the following typical applications:

- Video production studios
- Live broadcasting remote control
- CCTV and remote security applications

The package includes the following items:

- **VS-1x1 RS-232 Remote Controller** and power adapter (12V DC Input) and/or **VS-1Px1 Control Panel**
- This user manual¹ and the Kramer concise product catalog/CD

2 Getting Started

We recommend that you:

- Unpack the equipment carefully and save the original box and packaging materials for possible future shipment
- Review the contents of this user manual
- Use Kramer high performance high resolution cables²

¹ Download up-to-date Kramer user manuals from the Internet at this URL: <http://www.kramerelectronics.com/manuals.html>

² The complete list of Kramer cables is on our Web site at <http://www.kramerelectronics.com> (click "Cables and Connectors" in the Products section)

3 Your Remote Controller

The **VS-1xl RS-232 Remote Controller** interfaces between any **KRAMER RS-232** controlled switcher or matrix switcher and a remotely located simple switch assembly.

In particular, the **VS-1xl RS-232 Remote Controller**:

- Remotely controls a **KRAMER** switcher, without interfering with the local control performed by the built-in switches and without using a PC
- Can be used with the **VS-1Pxl Control Panel**¹, as Figure 2 illustrates

Achieving the best performance means:

- Connecting only good quality connection cables, thus avoiding interference, deterioration in signal quality, and elevated noise levels (often associated with low quality cables)
- Avoiding interference from neighboring electrical appliances and positioning your **Kramer VS-1xl RS-232 Remote Controller** in a location free from moisture and excessive sunlight and dust

Figure 1 and Table 1 define the **VS-1xl RS-232 Remote Controller**:

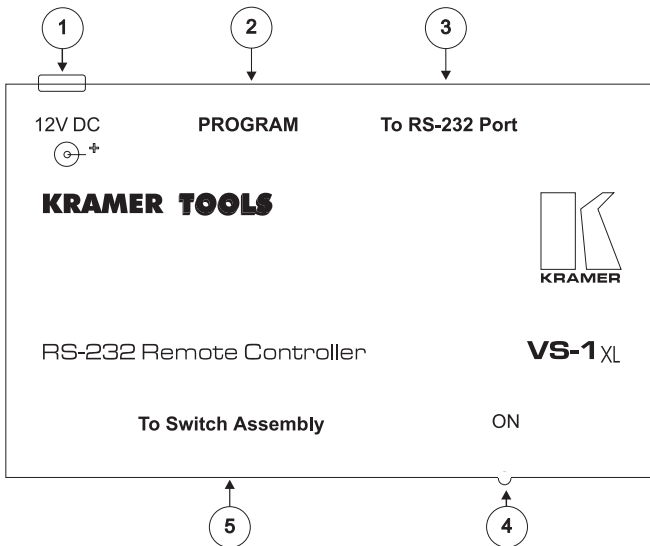

Figure 1: VS-1xl RS-232 Remote Controller

¹ An optional 24 switch assembly with 24 front panel buttons and a DB25F rear panel connector (see Figure 5 for the DB25 PINOUT)

Table 1: VS-1xl Features

#	Feature	Function
1	12V DC	+12V DC connector for powering the unit
2	PROGRAM	Dipswitches setup (refer to section 4.1)
3	To RS-232 Port	Connects to the DB9F RS-232 port on the Kramer switcher
4	ON LED	Illuminates when receiving power
5	To Switch Assembly	Connects to the DB25F port ¹ on the remote switch assembly ¹

Figure 2 defines the **VS-1PxI Control Panel**:

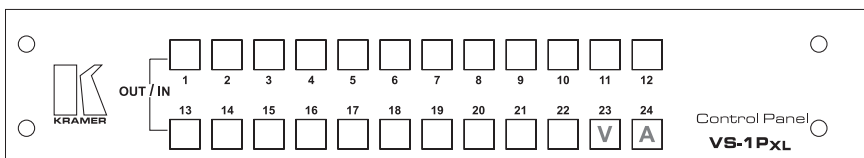

OUT / IN 23 (V) = Video Control
OUT / IN 24 (A) = Audio Control

Figure 2: VS-1PxI Control Panel

¹ For example, to the VS-1PxI Control Panel

4 Using Your Remote Controller

To use the **VS-1xl RS-232 Remote Controller**, do the following:

- Set the PROGRAM dipswitches (see section 4.1)
- Connect the “*To RS-232 Port*” DB9F port (see section 4.2)
- Connect the “*To Switch Assembly*” DB25F port (see section 4.2)

4.1 Setting the PROGRAM Dipswitches

Set the PROGRAM dipswitches to facilitate communication between the **VS-1xl RS-232 Remote Controller** and the Kramer switcher. The dipswitch settings are recognized when the **VS-1xl RS-232 Remote Controller** is turned ON¹. You can only connect one Kramer switcher at any time to the **VS-1xl RS-232 Remote Controller**².

Kramer switcher products are arranged in groups. Each group is controlled by a different protocol³. There are 13 different groups, numbered 1, 2, 4, 5, 6, 7, 9, 13, 14, 15, 16, 17 and 18 (there are no groups numbered 3, 8, 10, 11 or 12). In some cases, you will need to allocate different versions of the same unit to different groups.

The following Kramer switchers work with 2 protocols: **VS-4x4YC**, **VS-5x4**, **VS-1211**⁴, **VS-2616**. For example, the **VS-5X4** switcher appears in groups 6 and 18. Group 6 includes the old protocol (at the time that the **VS-5X4** was initially manufactured) and group 18 includes the new protocol⁵.

Set the PROGRAM dipswitches on the **VS-1xl** to facilitate communication between the **VS-1xl** and a Kramer switcher, by specifying the relevant Group. To set the PROGRAM dipswitches (as the example in section 4.1.1 describes):

1. In Table 2 (Group Classifications), find the name of the switcher that you want to control remotely.
The Group number is listed in the column to the right.
2. In Table 3 (Group Dipswitch Settings), find the Group number.
The PROGRAM dipswitch settings are listed in the column to the right.

1 Be sure to turn the VS-1xl OFF and then ON again if the dipswitches are altered while the VS-1xl is ON

2 You cannot connect several switchers (whether switchers of the same Group or of different Groups) to a RS-232 line

3 Each Kramer unit has an internal (serial) communication protocol

4 As well as the other switchers in the series: VS-411, VS-611, VS-811, VS-1011

5 Kramer Protocol-2000 (version 3.1 or higher)

Table 2: Group Classifications

SWITCHER	GROUP
2016	4
2031n	1
2066	9
2081	4
2088	7
2288	7
2466	9
2516	18
SD-7308	1
SD-7316	18
SD-7388	18
SD-7588A	18
SD-7588V	18
VP-23	17
VP-24	17, 18
VP-25xl	17, 18
VP-4x4	18
VP-61N	1
VP-61xl	1
VP-64	18
VP-66	18
VP-81	18
VP-82	18
VP-84	18
VP-88	18
VS-1001xl	15, 18

SWITCHER	GROUP
VS-1002xl	18
VS-1011	15, 16, 18
VS-120	14
VS-1201xl	15, 18
VS-1202	2
VS-1202xl	18
VS-1211	15, 16, 18
VS-1602xl	18
VS-1604	18
VS-1616	18
VS-162	18
VS-2042	4
VS-2053	4
VS-2216	13, 15, 18
VS-2481	4
VS-2516	13
VS-2616	13, 14, 18
VS-3000	18
VS-401	1
VS-401N	1
VS-401xl	15
VS-401xlm	18
VS-402	2, 18
VS-411	15, 16, 18
VS-4228	18
VS-4x4YC	5, 18

SWITCHER	GROUP
VS-5x4	6, 18
VS-601	1
VS-601N	1
VS-601xl	15
VS-601xlm	18
VS-602	2, 18
VS-606	14
VS-606xl	18
VS-611	15, 16, 18
VS-646	18
VS-801	1
VS-801N	1
VS-801xl	15
VS-801xlm	18
VS-802	2
VS-804xl	18
VS-804YC	18
VS-806YC	18
VS-808	14
VS-808xl	18
VS-811	15, 16, 18
VS-812	18
VS-848	18
VS-88A	18
VS-88V	18

Table 3: Group Dipswitch Settings

GROUP	SET PROGRAM DIPSWITCHES AS FOLLOWS:							
	1	2	3	4	5	6	7	8
1	OFF	OFF	OFF	OFF	ON	ON	OFF	OFF
2	ON	OFF	OFF	OFF	ON	ON	OFF	OFF
4	OFF	OFF	ON	ON	ON	ON	ON	ON
5	ON	ON	ON	OFF	ON	ON	ON	ON
6	OFF	ON	ON	OFF	ON	ON	ON	ON
7	ON	OFF	ON	OFF	ON	ON	ON	ON
9	ON	ON	OFF	OFF	ON	ON	ON	ON
13	OFF	ON	OFF	OFF	ON	ON	ON	ON
14	OFF	ON	OFF	ON	ON	ON	ON	ON
15	ON	ON	OFF	ON	ON	ON	ON	ON
16	ON	ON	ON	ON	OFF	ON	ON	ON
17	ON	OFF	ON	ON	ON	ON	ON	ON
18	OFF	ON	ON	ON	OFF	ON	ON	ON

4.1.1 Setting the PROGRAM Dipswitches on the VS-1xl (an example)

For example, to set the PROGRAM dipswitches on the VS-1xl when connecting a Kramer VS-4x4YC switcher (that is allocated to Group 5), do the following:

1. In Table 2 (Group Classifications), the VS-4x4YC switcher is listed with Group numbers 5 and 18 (using Group number 5 in this case).
2. In Table 3 (Group Dipswitch Settings), the PROGRAM dipswitch settings for Group number 5 are listed as the example in Figure 3 illustrates.

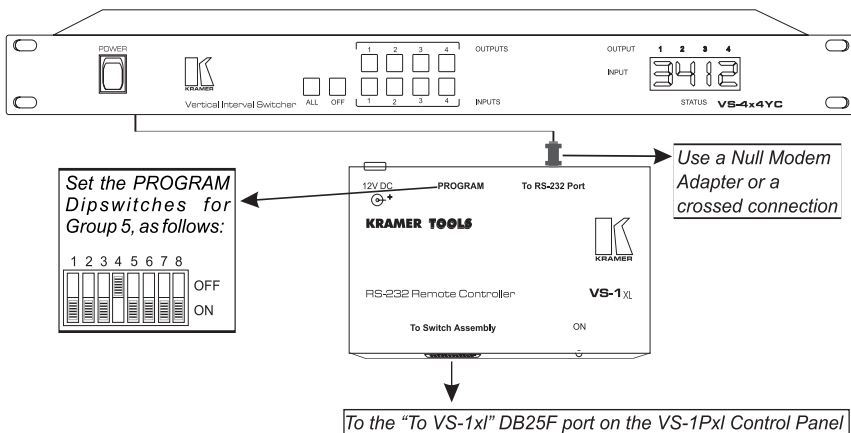

Figure 3: Setting the PROGRAM Dipswitches on the VS-1xl (an example)

4.1.2 Changing the Group Number

If you want to connect a different switcher—for example, a **VS-5x4** switcher (that is allocated to Group 6), instead of a **VS-4x4YC** switcher¹—change the Group Number (if required).

To change the Group Number, do the following:

1. Turn OFF the power on the **VS-1xl RS-232 Remote Controller** and on the **VS-4x4YC** switcher.
2. Disconnect the RS-232 cable from the RS-232 DB9F port on the **VS-4x4YC** switcher.
The other end of the RS-232 cable remains connected to the Null-modem adapter (see section 4.2.1), which is connected to the “*To RS-232 Port*” DB9F port on the **VS-1xl** switcher.
3. Connect the RS-232 cable from the “*To RS-232 Port*” DB9F port on the **VS-1xl RS-232 Remote Controller** to the RS-232 DB9F port on the **VS-5x4** switcher.
4. Reset the PROGRAM dipswitches on the **VS-1xl RS-232 Remote Controller**, according to Table 2 and Table 3.
5. Turn ON the power on the **VS-1xl RS-232 Remote Controller**.
Every time that you change the PROGRAM dipswitches, switch the power OFF and then ON again.

4.1.3 Routing Video and/or Audio via the VS-1PxI Control Panel

You can use your **VS-1PxI Control Panel** to route² video inputs to video outputs and³/or audio inputs to audio outputs, by setting the PROGRAM dipswitches on your **VS-1xl RS-232 Remote Controller** to one of the following Groups - 13, 16 and 18.

For example, to route video inputs to video outputs and/or audio inputs to audio outputs, via the **VS-1PxI Control Panel**, when controlling a **VS-1211** switcher, do the following:

1. Allocate the **VS-1211** switcher to Group 18, by setting the PROGRAM dipswitches according to Table 3.

¹ As described in section 4.1.1

² When routing an input to an output on a switcher set to the audio breakaway mode (in which video and audio channels switch independently)

³ When video and audio control are available. For example, allocating a VS-1616 switcher to Group 18 cannot enable VS-1PxI Control Panel toggle between video and audio control because the VS-1616 switcher excludes audio

2. On the **VS-1Pxl Control Panel**, press the OUT/IN button # 23¹ (which acts as the “V” button, as Figure 2 illustrates).
Control now focuses on video routing.
3. Press an OUT/IN button (say button # 2) on the **VS-1Pxl Control Panel**.
4. Press an OUT/IN button (say button # 5) on the **VS-1Pxl Control Panel**.
Video input 5 routes to video output 2.

To toggle from video control to audio control on the same **VS-1211** switcher (that is allocated to Group 18), do the following:

1. On the **VS-1Pxl Control Panel**, press the OUT/IN button # 24¹ (which acts as the “A” button, as Figure 2 illustrates).
Control now focuses on audio routing.
2. Press an OUT/IN button (say button # 3) on the **VS-1Pxl Control Panel**.
3. Press an OUT/IN button (say button # 7) on the **VS-1Pxl Control Panel**.
Audio input 7 routes to video output 3.

4.2 Connecting the Remote Controller

This section describes:

- Using a Null-modem adapter (see section 4.2.1)
- Connecting the **VS-1xl RS-232 Remote Controller** (see section 4.2.2)

4.2.1 Using a Null-modem Adapter or a One-to-One Connection

Usually, when connecting the **VS-1xl RS-232 Remote Controller**, you connect via a Null-modem adapter (see section 4.2.1.1).

4.2.1.1 Connection using a Null-modem Adapter (Basic Principle)

Except for the cases in 4.2.1.2 and 4.2.1.3, connecting the “To RS-232 Port” on the **VS-1xl** to a Kramer switcher the RS-232 connection must be via a Null-modem adapter or a crossed (Null-modem) connection.

4.2.1.2 Connection without a Null-modem Adapter (**VS-88A, VS-88V, VP-81, and VP-43xl**)

With some machines—the Kramer switchers: **VS-88A, VS-88V, and VP-81**, as well as the **VP-43xl Interface Converter**—always use a flat cable² (that is, NO Null-modem adapter).

¹ Pressing the OUT/IN button 23 or 24 is a quick method for frequent toggling between video and audio control for switchers arranged in Groups 13, 16 and 18

² Straight one-to-one uncrossed connections with at least the 3 wires pins # 2, # 3 and # 5

4.2.1.3 Connection using either a Flat Cable or a Null-modem Adapter (VS-1616A, VS-1616V, VS-1616AD, VS-1616SDI, VS-162V, and VS-162AV)

With certain Kramer switchers—**VS-1616A, VS-1616V, VS-1616AD, VS-1616SDI, VS-162V, and VS-162AV**— use a one-to-one connection (set **DIP 7 ON**). Alternatively, if you want, use a Null-modem adapter (set **DIP 7 OFF**).

4.2.2 Connecting the VS-1xl RS-232 Remote Controller

To connect your **VS-1xl RS-232 Remote Controller**, as Figure 4 illustrates:

1. Connect the “*To RS-232 Port*” DB9F port on the **VS-1xl** to the DB9 port on the Kramer switcher, using a Null-modem adapter (usual scenario) or a flat cable¹ (see section 4.2.1 for details).
2. Connect the “*To Switch Assembly*” DB25F port on the **VS-1xl** to the “*To VS-1xl*” DB25F port on the **VS-1PxI** Control Panel, using a DB 25 flat connector cable (see Figure 5 for the DB25 PINOUT).
3. Connect the 12V DC power adapter to the power socket and connect the adapter to the mains electricity.

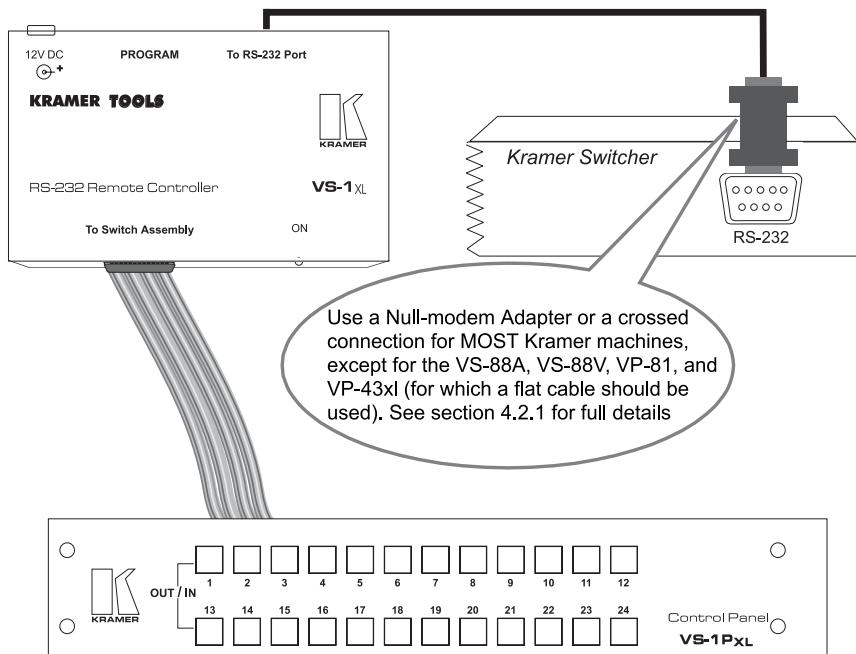

Figure 4: Connecting the VS-1xl RS-232 Remote Controller

¹ Straight one-to-one uncrossed connections with at least the 3 wires pins # 2, # 3 and # 5

4.2.3 Connecting the DB25 “To Switch Assembly” Connector

Figure 5 illustrates the DB25 “To Switch Assembly” connector PINOUT:

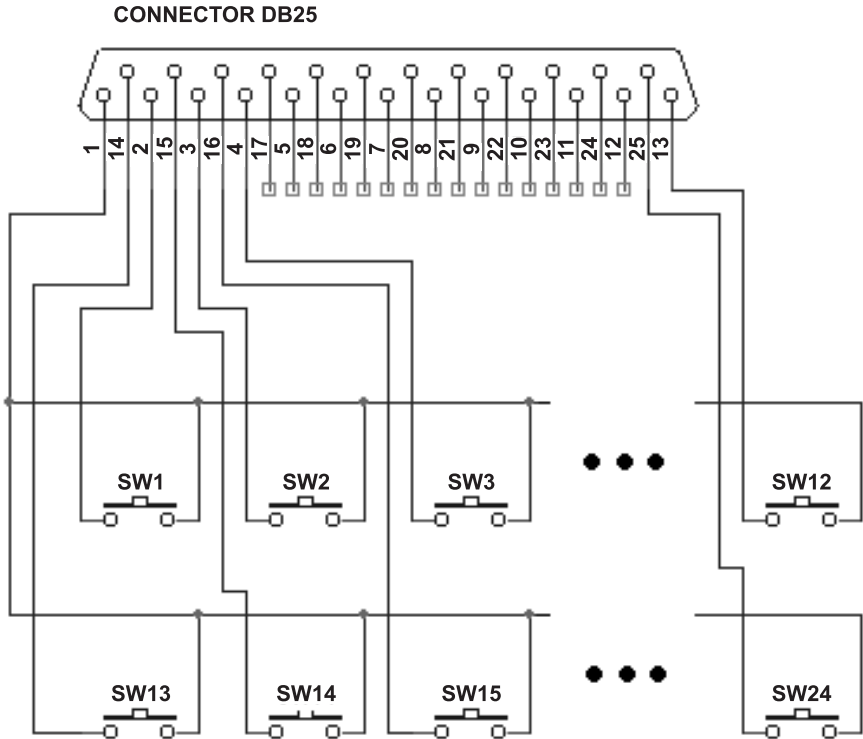

Figure 5: DB25 PINOUT

4.3 Operating Your Remote Controller

Section 4.3.1 describes how to operate your Remote Controller for all Groups of switchers except Group 2. Section 4.3.2 describes how to operate your Remote Controller for switchers that fall within Group 2. Section 4.3.3 describes how to operate your Remote Controller for switchers, **VP-23**, **VP-24** or **VP-25xl**.

4.3.1 For Switchers in Groups 1, 4, 5, 6, 7, 9, 13, 14, 15, 16, 17 and 18

To operate your **VS-1xl** RS-232 Remote Controller¹:

- Press the appropriate IN and OUT front panel buttons on the **VS-1Pxl** Control Panel

A connection command transfers to the switcher via the **VS-1xl** and the RS-232 link

4.3.1.1 Example - Connecting a Group 18 Switcher (VS-1616)

To route input 2 to output 8 via the **VS-1Pxl Control Panel**, when the **VS-1xl RS-232 Remote Controller** connects to a **VS-1616** switcher²:

- Press the OUT/IN button # 8 on the **VS-1Pxl Control Panel**
- Press the OUT/IN button # 2 on the **VS-1Pxl Control Panel**

Input 2 routes to output 8

4.3.1.2 Example - Connecting a Group 4 Switcher (VS-2042)

To connect an input via the **VS-1Pxl Control Panel**, when the **VS-1xl RS-232 Remote Controller** connects to a **VS-2042** switcher (allocated to Group 4):

- Press the OUT/IN button # 1, 2, 3 or 4 on the **VS-1Pxl Control Panel** to route INPUT A, B, C or D, respectively, to OUTPUT 1
- Press the OUT/IN button # 17, 18, 19 or 20 on the **VS-1Pxl Control Panel** to route INPUT A, B, C or D, respectively, to OUTPUT 2

¹ As an alternative, you can operate via the switcher's front panel buttons

² To route input 2 to output 8 from the VS-1616 switcher's front panel, press the OUT button # 8 on the VS-1616 switcher and then the IN button # 2 on the VS-1616 switcher

4.3.2 For Switchers in Group 2

To operate your **VS-1xl RS-232 Remote Controller** with Group 2 switchers, as Figure 6 (on page 13) illustrates:

1. Select BUS A or BUS B, by pressing the **VS-1Pxl Control Panel's** button:
 - # 1 to access BUS A; or
 - # 2 to access BUS B
2. Select an input, by pressing a **VS-1Pxl Control Panel's** button (from 1 to 12)¹

4.3.2.1 Example - Connecting a Group 2 Switcher (VS-1202YC)

To connect input 11 to BUS A via the **VS-1Pxl Control Panel**, when the **VS-1xl RS-232 Remote Controller** connects to a **VS-1202YC** switcher:

- Press the OUT/IN button # 1 on the **VS-1Pxl Control Panel**
- Press the OUT/IN button # 11 on the **VS-1Pxl Control Panel**

Input 11 connects to BUS A, as Figure 6 illustrates

To connect input 12 to BUS B via the **VS-1Pxl Control Panel**, when the **VS-1xl RS-232 Remote Controller** connects to a **VS-1202YC** switcher:

- Press the OUT/IN button # 2 on the **VS-1Pxl Control Panel**
- Press the OUT/IN button # 12 on the **VS-1Pxl Control Panel**

Input 12 routes to BUS B, as Figure 6 illustrates

¹ Buttons from 13 to 24 have no effect

Using Your Remote Controller

Pressing button # 1 on the **VS-1PXL** accesses BUS A, pressing button # 2 accesses BUS B

To access BUS A's INPUT 11 remotely, press button # 1 (to access BUS A) and then button # 11 (to access INPUT 11)

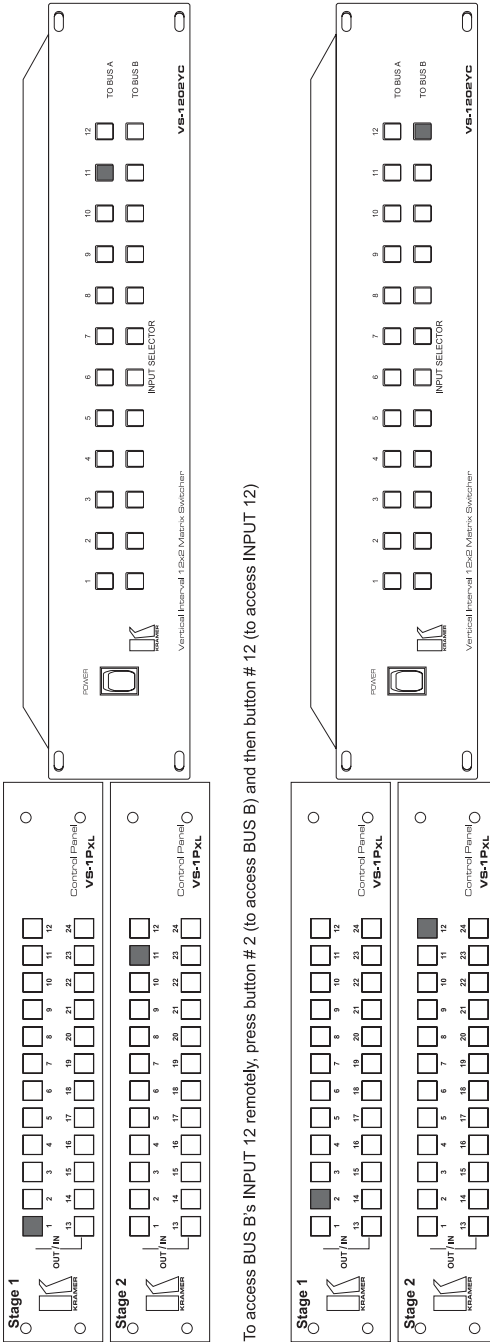

To access BUS B's INPUT 12 remotely, press button # 2 (to access BUS B) and then button # 12 (to access INPUT 12)

Figure 6: Operating Your Remote Controller for Group 2

4.3.3 For Switchers VP-23, VP-24 or VP-25xl

To operate the **VS-1xl RS-232 Remote Controller** with switchers **VP-23**, **VP-24** or **VP-25xl**, as Figure 7 (on page 16) illustrates:

1. Select the appropriate set of 4 selector buttons, by pressing one of the following **VS-1Pxl Control Panel** buttons¹:
 - # 1 to access the set of composite video-audio selector buttons
 - # 2 to access the set of s-Video-audio selector buttons
 - # 3 to access the set of VGA/XGA-Audio selector buttons
 - # 4 to access the set of Master Audio selector buttons
2. Select an input, by pressing a **VS-1Pxl Control Panel**'s button (from 1 to 4)²

4.3.3.1 Examples - Connecting a VP-23, VP-24 or VP-25xl Switcher

To connect s-Video-audio input 3 via the **VS-1Pxl Control Panel**, when the **VS-1xl RS-232 Remote Controller** connects to a **VP-23**, **VP-24** or **VP-25xl** switcher (when allocated to Group 17):

- Press the OUT/IN button # 2 on the **VS-1Pxl Control Panel**
- Press the OUT/IN button # 3 on the **VS-1Pxl Control Panel**

The s-Video-audio input 3 connects to the output, as Figure 7 illustrates

To connect composite video-audio input 1 via the **VS-1Pxl Control Panel**, when the **VS-1xl RS-232 Remote Controller** connects to a **VP-24** or **VP-25xl** switcher:

- Press the OUT/IN button # 1 on the **VS-1Pxl Control Panel**
- Press the OUT/IN button # 1 on the **VS-1Pxl Control Panel**

The composite video-audio input 1 connects to the output

To connect the CV Master Audio via the **VS-1Pxl Control Panel**, when the **VS-1xl RS-232 Remote Controller** connects to a **VP-24** or **VP-25xl** switcher:

- Press the OUT/IN button # 4 on the **VS-1Pxl Control Panel**
- Press the OUT/IN button # 1 on the **VS-1Pxl Control Panel**

The CV Master Audio connects to the Master Audio Out connector

4.3.4 For Switchers with a Single Output

To operate your **VS-1xl RS-232 Remote Controller** when a switcher has only one output (for **Groups 1, 4, 15** and **16**):

¹ The VS-1Pxl Control Panel toggle between video and audio control, as section 4.1.3 describes, is unavailable with a VP-23, VP-24 or VP-25xl switcher

² Buttons 5 to 24 have no effect

- Press the appropriate IN front panel button on the **VS-1Pxl Control Panel** (do not press any OUT front panel button).
A connection command transfers to the switcher via the **VS-1xl** and the RS-232 link

4.3.4.1 Examples - Connecting an SD-7308 or VS-120 Switcher

To operate your **VS-1xl RS-232 Remote Controller** with a **SD-7308** switcher (**Group 1**):

- Press the appropriate IN front panel button on the **VS-1Pxl Control Panel** (do not press any OUT front panel button).
A connection command transfers to the switcher via the **VS-1xl** and the RS-232 link

To operate your **VS-1xl RS-232 Remote Controller** with a **VS-120** switcher (**Group 14**):

- Press the appropriate IN front panel button on the **VS-1Pxl Control Panel** followed by an OUT (representing MACHINE #) front panel button

5 Technical Specifications

Table 4 and Table 5 include the technical specifications for the **VS-1xl RS-232 Remote Controller** and the **VS-1Pxl Control Panel**, respectively:

Table 4: VS-1xl RS-232 Remote Controller Technical Specifications

Inputs:	Up to 24 remote momentary switches on a DB25F connector
Output:	DB9 connector for link to a Kramer switcher
Controls:	Up to 24 remote key switches; 8 Dipswitches for programming
Dimensions:	12 cm x 7.5 cm x 2.5 cm (4.7" x 2.95" x 0.98", W, D, H)
Power Source:	12 VDC, 100 mA
Weight:	0.25 kg (0.6 lbs.) approx.
Accessories:	Power supply, mounting bracket
Options:	RK-T1 or RK-T3 rack mount kit

Table 5: VS-1Pxl Control Panel Technical Specifications

Output:	DB25F connector
Controls:	24 front panel buttons
Dimensions:	25.5 cm x 4.5 cm x 2.8 cm (10.04" x 1.77" x 1.1", W, D, H)
Weight:	0.22 kg (0.49 lbs.) approx.

Technical Specifications

To select s-Video-Audio Selector button # 3, press button # 2 (to access the s-Video-Audio Selector buttons) and then press button # 3 (to select the s-Video/audio source # 3)

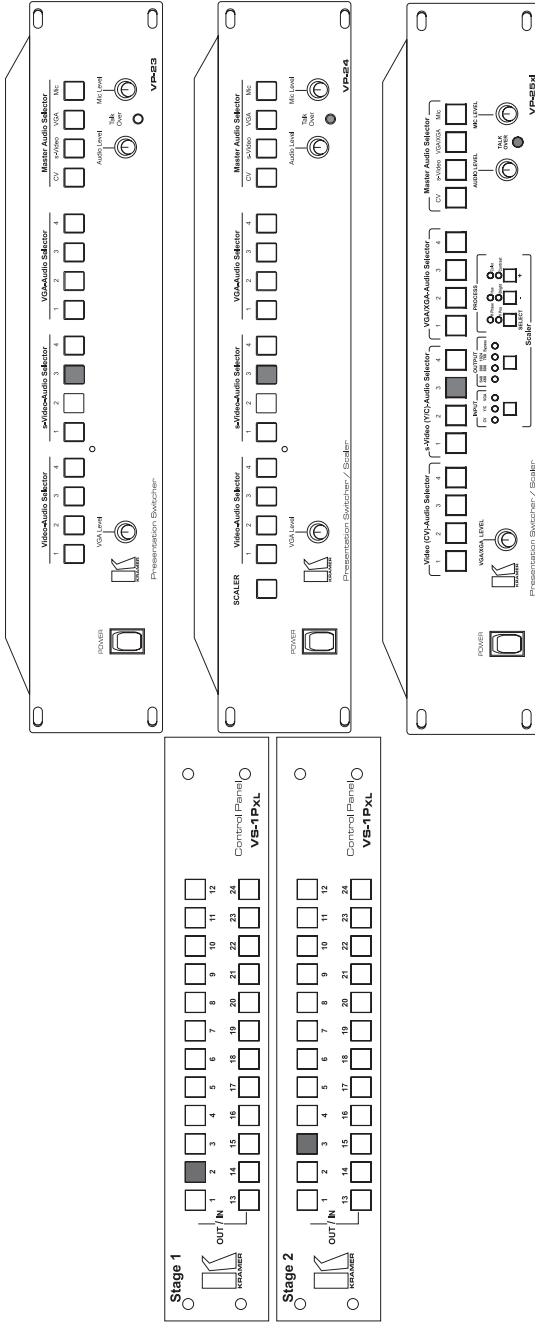

Figure 7. Operating Your Remote Controller with Switchers VP-23, VP-24 or VP-25xl

LIMITED WARRANTY

Kramer Electronics (hereafter *Kramer*) warrants this product free from defects in material and workmanship under the following terms.

HOW LONG IS THE WARRANTY

Labor and parts are warranted for three years from the date of the first customer purchase.

WHO IS PROTECTED?

Only the first purchase customer may enforce this warranty.

WHAT IS COVERED AND WHAT IS NOT COVERED

Except as below, this warranty covers all defects in material or workmanship in this product. The following are not covered by the warranty:

1. Any product which is not distributed by Kramer, or which is not purchased from an authorized Kramer dealer. If you are uncertain as to whether a dealer is authorized, please contact Kramer at one of the agents listed in the web site www.kramerelectronics.com.
2. Any product, on which the serial number has been defaced, modified or removed.
3. Damage, deterioration or malfunction resulting from:
 - i) Accident, misuse, abuse, neglect, fire, water, lightning or other acts of nature
 - ii) Product modification, or failure to follow instructions supplied with the product
 - iii) Repair or attempted repair by anyone not authorized by Kramer
 - iv) Any shipment of the product (claims must be presented to the carrier)
 - v) Removal or installation of the product
 - vi) Any other cause, which does not relate to a product defect
 - vii) Cartons, equipment enclosures, cables or accessories used in conjunction with the product

WHAT WE WILL PAY FOR AND WHAT WE WILL NOT PAY FOR

We will pay labor and material expenses for covered items. We will not pay for the following:

1. Removal or installations charges.
2. Costs of initial technical adjustments (set-up), including adjustment of user controls or programming. These costs are the responsibility of the Kramer dealer from whom the product was purchased.
3. Shipping charges.

HOW YOU CAN GET WARRANTY SERVICE

1. To obtain service on you product, you must take or ship it prepaid to any authorized Kramer service center.
2. Whenever warranty service is required, the original dated invoice (or a copy) must be presented as proof of warranty coverage, and should be included in any shipment of the product. Please also include in any mailing a contact name, company, address, and a description of the problem(s).
3. For the name of the nearest Kramer authorized service center, consult your authorized dealer.

LIMITATION OF IMPLIED WARRANTIES

All implied warranties, including warranties of merchantability and fitness for a particular purpose, are limited in duration to the length of this warranty.

EXCLUSION OF DAMAGES

The liability of Kramer for any effective products is limited to the repair or replacement of the product at our option. Kramer shall not be liable for:

1. Damage to other property caused by defects in this product, damages based upon inconvenience, loss of use of the product, loss of time, commercial loss; or
2. Any other damages, whether incidental, consequential or otherwise. Some countries may not allow limitations on how long an implied warranty lasts and/or do not allow the exclusion or limitation of incidental or consequential damages, so the above limitations and exclusions may not apply to you.

This warranty gives you specific legal rights, and you may also have other rights, which vary from place to place.

NOTE: All products returned to Kramer for service must have prior approval. This may be obtained from your dealer.

This equipment has been tested to determine compliance with the requirements of:

EN-50081:	"Electromagnetic compatibility (EMC); generic emission standard. Part 1: Residential, commercial and light industry"
EN-50082:	"Electromagnetic compatibility (EMC) generic immunity standard. Part 1: Residential, commercial and light industry environment".
CFR-47:	FCC Rules and Regulations: Part 15: "Radio frequency devices Subpart B – Unintentional radiators"

CAUTION!

- ☒ Servicing the machines can only be done by an authorized Kramer technician. Any user who makes changes or modifications to the unit without the expressed approval of the manufacturer will void user authority to operate the equipment.
- ☒ Use the supplied DC power supply to feed power to the machine.
- ☒ Please use recommended interconnection cables to connect the machine to other components.



For the latest information on our products and a list of Kramer distributors, visit our Web site: www.kramerelectronics.com.

**Updates to this user manual may be found at
<http://www.kramerelectronics.com/manuals.html>.**

We welcome your questions, comments and feedback.



Kramer Electronics, Ltd.

Web site: www.kramerelectronics.com

E-mail: info@kramerelect.com

P/N: 2900-002034 REV 3

Free Manuals Download Website

<http://myh66.com>

<http://usermanuals.us>

<http://www.somanuals.com>

<http://www.4manuals.cc>

<http://www.manual-lib.com>

<http://www.404manual.com>

<http://www.luxmanual.com>

<http://aubethermostatmanual.com>

Golf course search by state

<http://golfingnear.com>

Email search by domain

<http://emailbydomain.com>

Auto manuals search

<http://auto.somanuals.com>

TV manuals search

<http://tv.somanuals.com>