

User Guide | Guide de l'utilisateur | Guía del Usuario



LCD TV
TV ACL | TV con Pantalla LCD

NS-LCD26F/NS-LCD32F/NS-CL26C

Insignia NS-LCD26F/ NS-LCD32F/ NS-CL26C LCD TV

static electricity charges. Section 810 of the National Electrical Code provides information on proper grounding of the mast and supporting structure, grounding of the lead-in wire to an antenna discharge unit, size of the grounding conductors, location of the antenna discharge unit, connection to grounding electrodes, and requirements for the grounding electrode.

Contents

Welcome	3
Safety information	3
Features	5
Accessories	5
Front and side views	5
Rear view - connectors	6
Remote control	6
Setting up your TV	7
Installing the remote control batteries	7
Using the remote control	7
Connecting to video sources	7
Using your TV	9
Turning the power on and off	9
Changing the volume	9
Changing the video source	9
Changing channels	9
Programming channels into memory	9
Displaying status information	10
Setting the sleep timer	10
Viewing closed captions	10
Setting parental controls	10
Using the DVD player (NS-CL26C only)	12
Playing a DVD	12
Playing a CD	13
Playing a Kodak picture CD or JPEG disc	14
Customizing TV settings	14
Opening and navigating the on-screen menus	14
Using the on-screen menu	14
On-screen menus	15
Customizing DVD player settings	16
Using the setup menu	16
Changing DVD settings	16
Customizing DVD player settings	16
Maintaining	17
Specifications	18
Legal Notices	18
1 Year Limited Warranty	19
Français	21
Español	23

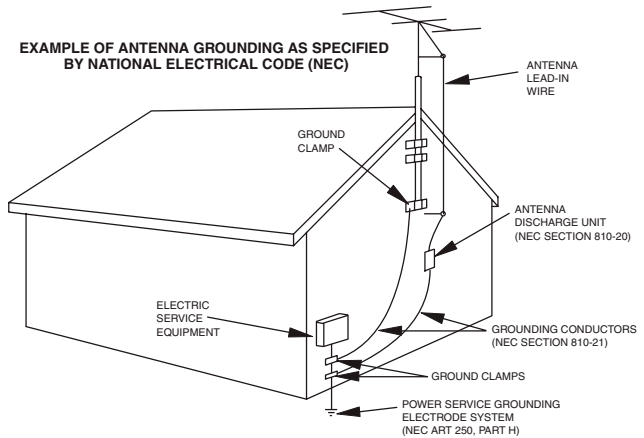

- For added protection during a lightning storm, or when the product is left unattended and unused for long periods of time, unplug it from the power outlet and disconnect the antenna. This will prevent damage to the equipment due to lightning and power line surges.
- An outside antenna system should not be located near overhead power lines or other electric light or power circuits, or where it can fall into such power lines or circuits. When installing an outside antenna system, extreme care should be taken to keep from touching such power lines or circuits, because contact with them can be fatal.

Risk of shock

To prevent fire or shock hazard, do not expose this appliance to rain or moisture.



Welcome

Congratulations on your purchase of a high-quality Insignia product. Your new TV represents the state of the art in television design, and is designed for reliable and trouble-free performance.

Safety information

Antenna connections

If an outside antenna is connected to the television equipment, make sure that the antenna system is grounded to provide protection against voltage surges and built-up

	The lightning flash with arrowhead symbol, within an equilateral triangle is intended to alert the user to the presence of uninsulated dangerous voltage within the product's enclosure that may be of sufficient magnitude to constitute a risk of electric shock.
	The exclamation point within an equilateral triangle is intended to alert the user to the presence of important operating and maintenance (servicing) instructions in the literature accompanying the appliance.

Warning

Do not overload wall outlets. Overloaded wall outlets, loose or damaged wall outlets, overloaded extension cords, frayed power cords, or damaged or cracked wire insulation are dangerous. Any of these conditions could result in electric shock or fire. Periodically examine the cord of your TV, and if its appearance indicates damage or deterioration, unplug it, discontinue use of the TV, and have the cord replaced with an exact replacement part by an authorized servicer.

Protect the power cord from physical or mechanical abuse, such as being twisted, kinked, pinched, closed in a door, or walked upon. Pay particular attention to plugs, wall outlets, and the point where the cord exits the TV.

To prevent electric shock, do not use this polarized plug with an extension cord, receptical, or other outlet unless the blades can be fully inserted to prevent blade exposure.

Caution

Your TV should not be exposed to water (dripping or splashing) and no objects filled with liquids, such as vases, should be placed on the apparatus.

such as power-supply cord or plug is damaged, liquid has been spilled or objects have fallen into the apparatus, the apparatus has been exposed to rain or moisture, does not operate normally, or has been dropped.

The apparatus shall not be exposed to dripping or splashing and no objects filled with liquids, such as vases, shall be placed on the apparatus. The AC power plug is used as the disconnect device, it must be readily available during normal use.

Important Safety Instructions

- 1 Read these instructions.
- 2 Keep these instructions.
- 3 Heed all warnings.
- 4 Follow all instructions.
- 5 Do not use this apparatus near water.
- 6 Clean only with dry cloth.
- 7 Do not block any ventilation openings. Install in accordance with the manufacturer's instructions.
- 8 Do not install near any heat sources such as radiators, heat registers, stoves, or other apparatus (including amplifiers) that produce heat.
- 9 Do not defeat the safety purpose of the polarized or grounding-type plug. A polarized plug has two blades with one wider than the other. A grounding type plug has two blades and a third grounding prong. The wide blade or the third prong are provided for your safety. If the provided plug does not fit into your outlet, consult an electrician for replacement of the obsolete outlet.
- 10 Protect the power cord from being walked on or pinched particularly at plugs, convenience receptacles, and the point where they exit from the apparatus.
- 11 Only use attachments/accessories specified by the manufacturer.
- 12 Use only with the cart, stand, tripod, bracket, or table specified by the manufacturer, or sold with the apparatus. When a cart is used, use caution when moving the cart/apparatus combination to avoid injury from tip-over.
- 13 Unplug this apparatus during lightning storms or when unused for long periods of time.
- 14 Refer all servicing to qualified service personnel. Servicing is required when the apparatus has been damaged in any way,



Features

Accessories

Make sure that the following accessories are provided in the packaging:

- Remote control
- Batteries (two - AA)
- User Guide

Front and side views

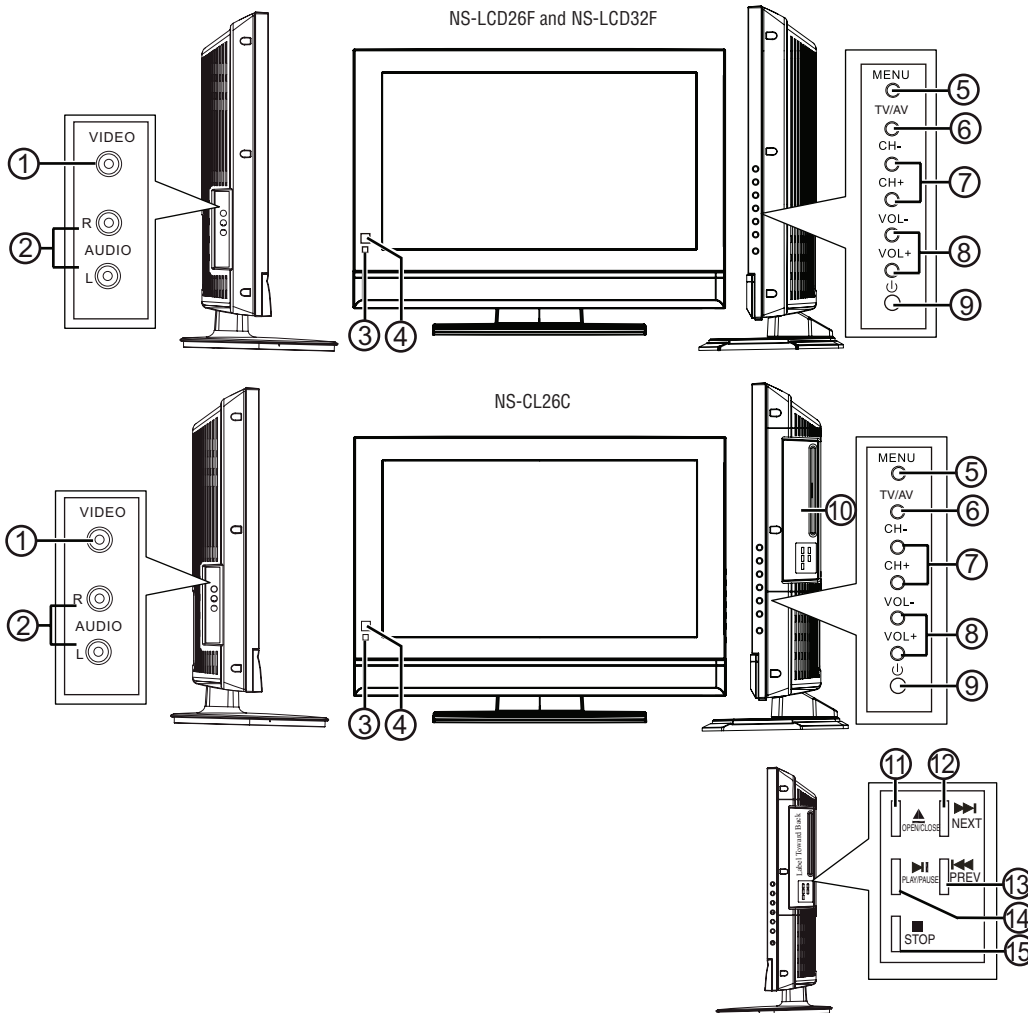

Item	Description
1	VIDEO output jack
2	Right and Left AUDIO output jacks
3	Power Indicator LED. Turns green when the TV is turned on and turns yellow when the TV is in standby mode.
4	Remote sensor. Receives signals from the remote control.
5	MENU button. Press to open the main on screen menu.
6	INPUT button. Press to select the AV signal input between TV, AV1, AV2, S-VIDEO, YPBPR, VGA, HDMI, and DVD.
7	CH -/+ buttons. Press to change the channel.
8	VOL -/+ buttons. Press to decrease or increase the volume.
9	POWER button. Press to turn on and turn off the TV.
10	DVD player (NS-CL26C only)

Item	Description
11	Open/Close button. Press to open or close the disc tray.
12	NEXT button. Press to go to the next chapter or track. Press again to skip forward by chapter or track.
13	PREV button. Press to go to the beginning to the current chapter or track. Press again to skip back by chapter or track.
14	PLAY/PAUSE button. Press to play the disc, press again to pause playback.
15	STOP button. Press to stop DVD and CD playback.

Rear view - connectors

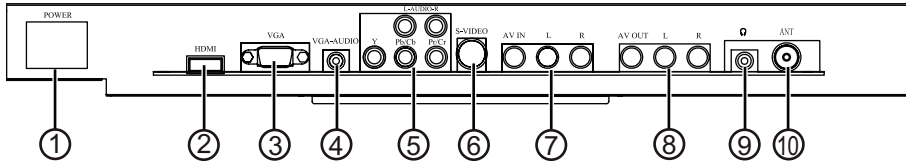

Item	Description
1	Power input jack
2	HDMI input jack
3	VGA (D-sub) input jack
4	VGA audio input jack
5	Component (YPbPr) and Audio (L and R) input jacks
6	S-Video input jack
7	AV IN Composite video/audio input jacks
8	AV OUT Composite video/audio output jacks
9	Headphone jack
10	RF (75 ohm) antenna connector

Item	Description
1	POWER button. Press to turn the TV on and off.
2	INPUT button. Press to select the AV signal input between TV, AV, S-VIDEO, PC, COMPONENT, and DVD.
3	SCAN button. Press to scan through memorized TV channels.
4	MTS/SAP button. Press to select Stereo, Mono, or SAP mode.
5	Number buttons: Press to directly enter channel numbers, DVD chapter numbers, and CD track numbers.
6	RECALL button. While in TV mode, press to return to the previous channel.
7	CH +/- buttons. Press to skip to the previous or next channel while in TV mode. In other modes (except DVD mode), press to change to TV mode. VOL +/- buttons. Press to change the volume.
8	MENU button. Press to open the TV menu. Press again to exit.
9	EXIT button. Press to turn off the on screen display.
10	TITLE button. Press to display the current DVD title.
11	DISPLAY button. Press to show information about the DVD playing.
12	REV button. Press to fast reverse a DVD.
13	FWD button. Press to fast forward a DVD.
14	DVD MENU button. Press to open the DVD root menu.
15	PLAY/ENTER button. Press to begin disc playback, or in menu mode to confirm your selections.
16	cursor buttons: Press to navigate in on screen menus.
17	ANGLE button. Press to change the DVD viewing angle.
18	AUDIO button. Press to change the DVD audio language/options.
19	PROGRAM button. Press to enter DVD program mode. In CD mode, pressing this button switches between "Folder" and "Filelist." Folder means play the tracks in current folder, and Filelist means play all tracks on the disk.
20	OPEN/CLOSE button. Press to open or close the disc tray.
21	TV/DVD button. Press to switch between the current inputs and DVD.
22	PICTURE button. Press to cycle through the picture modes (Personal, Standard, Mild, and Fresh).
23	SLEEP button. Press to set the sleep timer.
24	CCD button. Press to select Close Captions modes while in TV, DVD, AV, or S-VIDEO mode.
25	10+ button. If the track or channel number is over 10, press this button once, then a button 1-9.
26	MUTE button. Press to mute the sound.
27	DISPLAY button. Press to show TV channel information.
28	SUBTITLE button. Press repeatedly until the subtitle language you want is selected.
29	SETUP button. Press to open the DVD Setup menu.

Remote control

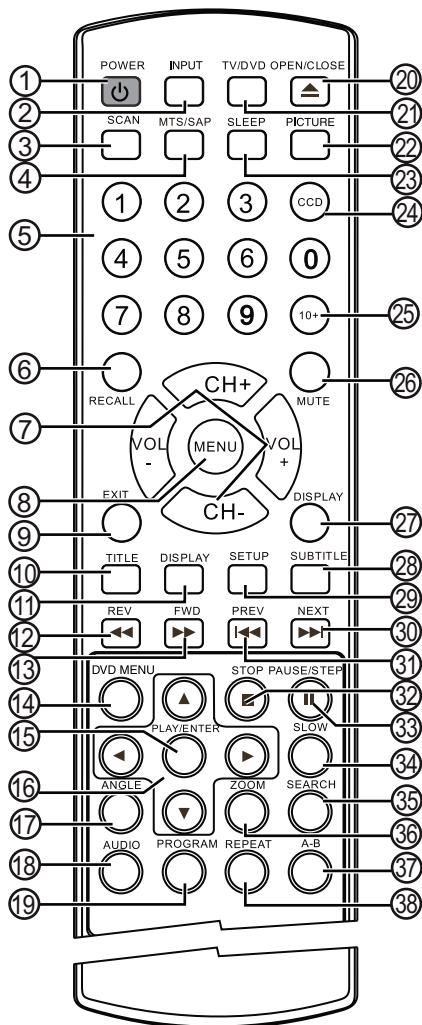

Item	Description
30	▶▶ NEXT button. Press to go to the next chapter or track. Press again to skip forward by chapter or track.
31	◀◀ PREV button. Press to go to the previous chapter or track. Press again to skip back by chapter or track.
32	■ STOP button. Press to stop DVD and CD playback.
33	 PAUSE/STEP button. Press to pause DVD playback. Press again to step through a DVD one frame at a time.
34	SLOW button. Press to decrease the DVD playback speed.

Note

Objects between the remote control and the sensor may weaken the remote control's IR signal. Range can be diminished by direct sunlight shining on the TV's IR sensor.

Cautions

Do not expose the remote control to liquids, direct sunlight, or shock.

The remote control may not work correctly if the TV's IR sensor is under direct sunlight or strong lighting. In these cases, change the angle of the lighting or the TV screen, or operate the remote control closer to the IR sensor.

Setting up your TV

Installing the remote control batteries

To install the batteries:

- 1 Open the battery compartment (1) on the back of the remote control.

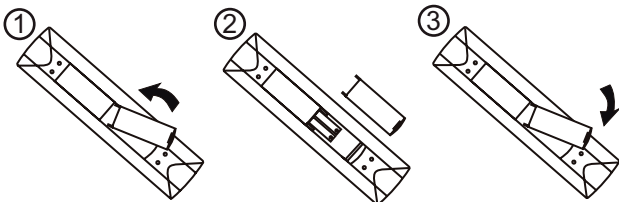

- 2 Insert the two AA batteries (2)(provided) into the battery compartment. Make sure that the (+) and (-) symbols on the batteries match the diagram inside the compartment.
- 3 Close the battery compartment (3).

Using the remote control

To use the remote control:

- Point it directly at the TV, within a 30° angle of the IR sensor on the front of the TV, and within 20 feet.

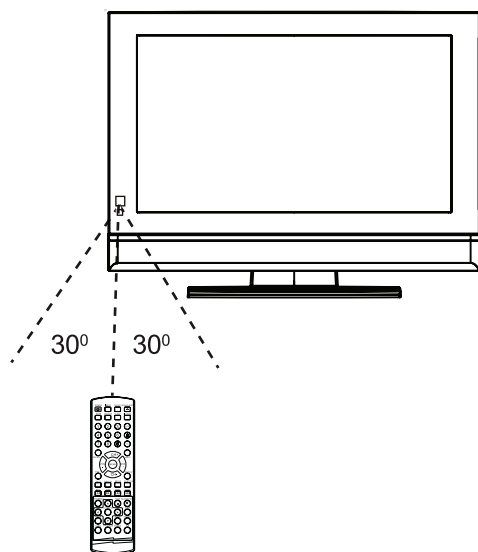

Connecting to video sources

Connecting to an antenna or cable/satellite receiver

To connect an external antenna or cable/satellite receiver:

- 1 Connect the antenna cable from an antenna or cable/satellite receiver to the antenna input jack on the TV.
- 2 Press the **INPUT** button to set the TV's signal input to **TV**.

Notes

- To improve picture quality in a poor signal area, you can purchase and install a signal amplifier.
- To split the signal from an antenna, you will need a 2-way signal splitter.

Connecting to a VCR

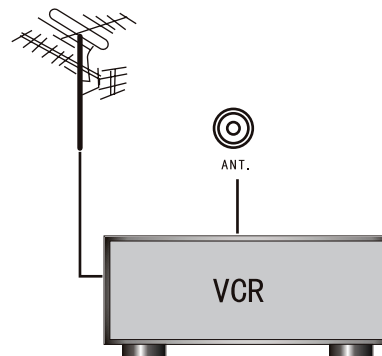
**To connect your TV to a VCR:**

- 1 Turn off the TV and the VCR (or other source).
- 2 Connect an RF cable to the VCR, then to the ANT. jack on the back of the TV.
- 3 Connect RCA audio cables to the VCR's audio output jacks, then to the AV IN L and R jacks on the back of the TV.
- 4 Turn on the TV and the VCR.
- 5 Press the **INPUT** button to set the TV's signal input to **TV**.

Connecting to a DVD or other video source

To connect your TV to a DVD or other video source:

- 1 Turn off the TV and the DVD (or other source).

2 Connect RCA video and audio cables from the DVD player to the VIDEO and AUDIO IN jacks on the back of your TV.

- Yellow - Video
- White - Audio left
- Red - Audio right

- OR -

Connect an S-Video cable and audio cables from the DVD player to the S-VIDEO and AUDIO IN (L and R) jacks on the back of your TV.

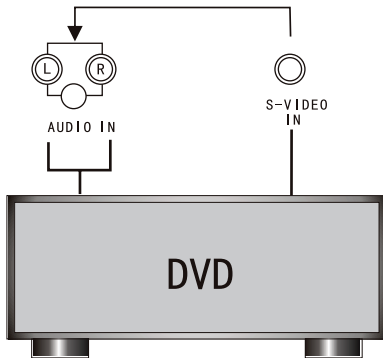

- White - Audio left
- Red - Audio right

- OR -

Connect RCA cables to the DVD's COMPONENT VIDEO Out jacks and the AUDIO OUT jacks (L and R), then to the COMPONENT IN jacks (Y, Cb/Pb, and Cr/Pr) and the AUDIO IN (L and R) jacks on the back of the TV.

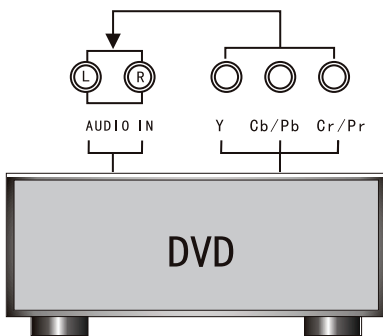

- 3 Turn on the TV and the VCR.
- 4 Press the **INPUT** button to set the TV's signal input to **S-VIDEO** or **YPBPR** (as appropriate).

To connect your TV to a DVD player with an HDMI cable:

- 1 Turn off the TV and the DVD player.
- 2 Connect an HDMI cable to the HDMI output jack on the DVD player, then connect it to the HDMI jack on your TV.

3 Press the **INPUT** button to set the TV's signal input to **HDMI**.

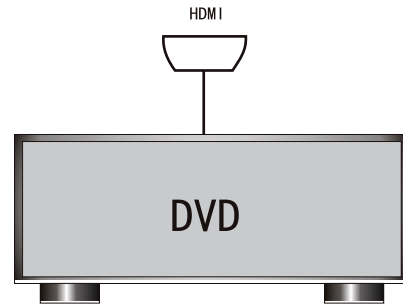

Connecting to a cable box

To connect your TV to a cable box with an RF cable:

- 1 Turn off the TV and the cable box.
- 2 Connect a 75 ohm RF cable from the cable box to the ANT. jack on the back of your TV.
- 3 Set the cable box output switch to channel 3 or 4, then tune your TV to the same channel.
- 4 Turn on the TV and the cable box.
- 5 Change channels at the cable box or with the cable box remote.

To connect your TV to a cable box with a AV cables:

- 1 Turn off the TV and the cable box.
- 2 Connect RCA video and audio cables from the cable box to the VIDEO and AUDIO IN jacks on the back of your TV.
 - Yellow - Video
 - White - Audio left
 - Red - Audio right
- 3 Turn on the TV and the cable box.
- 4 Press the **INPUT** button to set the TV's signal input to **AV** or **S-VIDEO**.
- 5 Change channels at the cable box or with the cable box remote.

Connecting to a computer

To connect a computer video source to the VGA jacks:

- 1 Connect a VGA cable from the computer to the **VGA** jack on the TV.

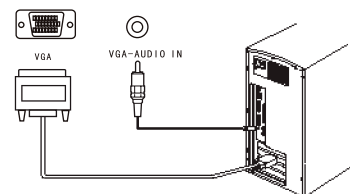

- 2 Connect a male-to-male audio cable from the computer to the **PC AUDIO IN** port on the TV.
- 3 Turn on the TV, then turn on the PC.
- 4 Press the **INPUT** button to set the TV's signal input to **VGA**.

Using your TV

Turning the power on and off

To turn the power on and off:

- 1 Press the **POWER** button on the front panel of the TV or on the remote control. The **POWER** indicator turns green.
- 2 To turn off the TV, press the **POWER** button again. The screen image disappears and the **POWER** indicator turns yellow (standby status).

Note

A small amount of electric power is consumed even when the power is turned off.

Changing the volume

You can change the volume using the TV's front panel or the remote control.

To change the volume:

- 1 Press **VOL+** or **VOL-**.
- 2 Press **MUTE** on the remote control to mute the sound, and press it again (or the **VOL+** or **VOL-**) to restore the sound.

Changing the video source

Your TV supports multiple video sources.

To select the video source:

- Press the **INPUT** button to select from the following input modes:
 - **TV**
 - **AV1**
 - **AV2**
 - **S-VIDEO**
 - **YPBPR**
 - **VGA**
 - **HDMI**
 - **DVD**

The name of the input source appears on the screen when it is selected.

Notes on HDMI

- HDMI™ - The HDMI logo and High-Definition Multimedia Interface is a trademark or registered trademark of HDMI Licensing.
- This TV can receive HDMI.
- This TV supports the HDCP (High-bandwidth Digital Contents Protection) protocol for 720×480p, 1280×720p, and 1920×1080i resolution.
- When connected to a source device (DVD player, set top box, or PC) supporting the Auto HDMI function, the output resolution of the source device will be set automatically to 1280×720p. If the source device does not support Auto HDMI, you must set the output resolution appropriately. For best picture quality, adjust the DVD player, set top box output resolution to 1280×720p, or the PC graphics card output to 1280×768, 60 Hz.
- If the source device has HDMI output, no audio connection is necessary.

Changing channels

To change channels:

- Press **CH+** or **CH-**.

To enter a channel number directly:

- Press the number buttons on the remote control.

To switch between two channels:

- 1 Press **RECALL** to change from the currently tuned channel to the previous channel.
- 2 Press **RECALL** again to change back to the originally tuned channel.

Changing the picture mode

To change the picture mode:

- Press **PICTURE** on the remote control to cycle through the following modes:
 - **STANDARD**—normal mode
 - **SOFT**—softens the image
 - **USER**—set the image effect you want
 - **BRIGHT**—suitable for sports images

Programming channels into memory

To select the channel source:

- 1 Press **MENU** on the TV or remote control, then press **VOL-** or **VOL+** to access the **TUNER** menu. The **TUNER** menu opens.

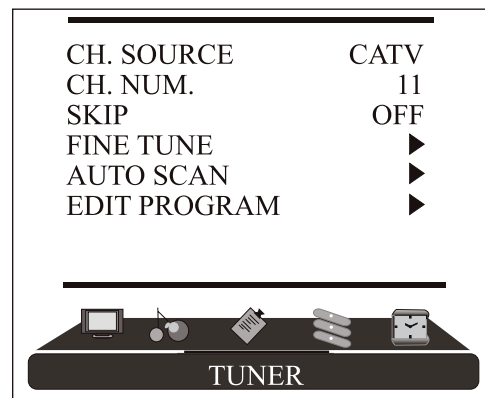

- 2 Press **CH-** or **CH+** to select **CH.SOURCE**, then press **VOL-** or **VOL+** to choose **CATV** or **AIR**.

To automatically program channels into memory:

- 1 Press **MENU** on the TV or remote control, then press **VOL-** or **VOL+** to access the **TUNER** menu. The **TUNER** menu opens.

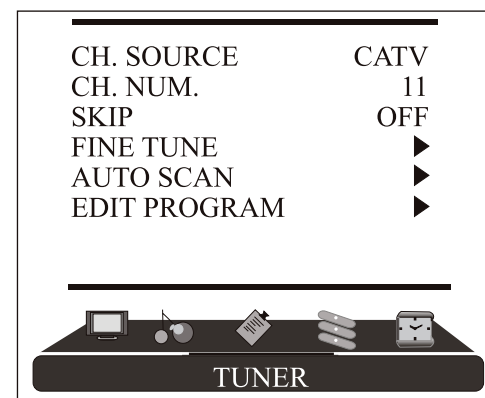

- 2 Press **CH-** or **CH+** to select **AUTO SCAN**, then press **VOL-** or **VOL+** to begin searching.

- 3 The TV searches and memorizes all channels on the selected antenna input available in your area.
- 4 To stop the auto scan, press **MENU**.

To edit programmed channels:

- 1 Press **MENU** on the TV or remote control, then press **VOL-** or **VOL+** to access the *TUNER* menu. The *TUNER* menu opens.

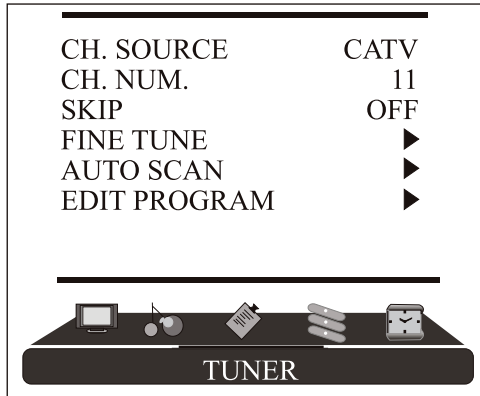

- 2 Press **CH-** or **CH+** to select **EDIT PROGRAM**, then press **VOL-** or **VOL+** to enter the sub-menu. The *Edit Program* sub-menu opens.

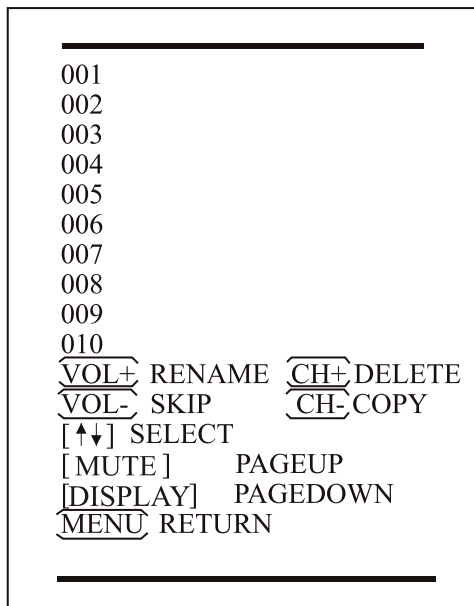

- 3 Press **CH-** or **CH+** to select the channel. Then you can:
 - Rename the channel by pressing the **VOL+** button.
 - Skip the channel by pressing the **VOL-** button.
 - Delete the channel by pressing the **CH+** button
 - Copy the channel by pressing the **CH-** button
- 4 To cancel the action, press the **VOL-** button.

Displaying status information

To display status information:

- Press the **DISPLAY** button. Your TV displays status information, such as the channel number or signal source.

Setting the sleep timer

The sleep timer lets you select the amount of time before your TV turns off automatically.

To set the sleep timer:

- Press the **SLEEP** button on the remote control repeatedly until the time duration you want is shown on the screen. Options include:
 - **SLEEP 240 MIN**
 - **SLEEP 180 MIN**
 - **SLEEP 120 MIN**
 - **SLEEP 90 MIN**
 - **SLEEP 60 MIN**
 - **SLEEP 45 MIN**
 - **SLEEP 30 MIN**
 - **SLEEP 15 MIN**
 - **SLEEP 10 MIN**
 - **SLEEP 5 MIN**
 - **SLEEP 0**

Viewing closed captions

To view closed captions:

- Press the **CCD** button to toggle the closed captions on or off.

Setting parental controls

Your TV has a V-chip that lets you control the type of programs your children can watch. Parental controls include two ratings: MPAA (based on age) and TV Parental Guidelines (based on content and age). A TV program may have an MPAA or TV Parental Guidelines rating, so you should set controls for both ratings. Before you can select ratings, you need to set up a parental controls password.

To set up a password:

- 1 Press **MENU** on the TV or remote control, then press **VOL-** or **VOL+** to select the *FUNCTION* menu. The *FUNCTION* menu opens.

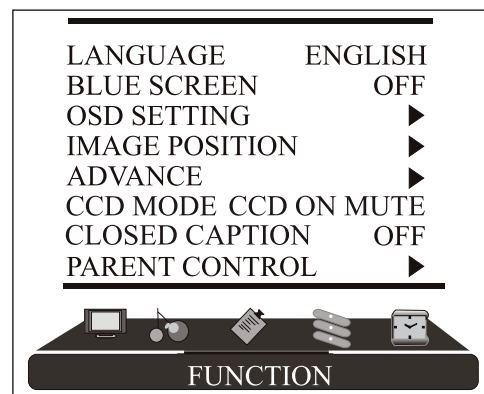

- 2 Press **CH-** or **CH+** to select **PARENT CONTROL**, then press **VOL-** or **VOL+**. The *Password box* opens.



- 3 Press the number buttons to enter **0000** (the default initial password). The *PARENT CONTROL* menu opens.

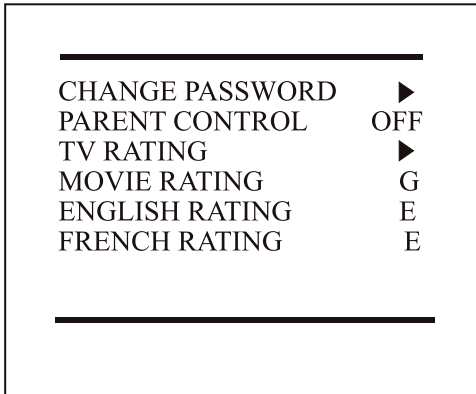

- 4 **CH-** or **CH+** to select **CHANGE PASSWORD**, then press **VOL-** or **VOL+**. The *Password Change box* opens.



- 5 Press the number buttons to enter a new password. You are asked to enter the new password again.

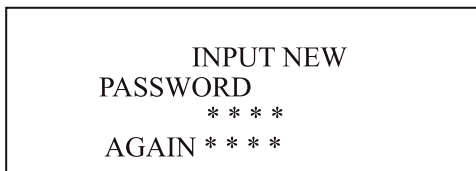

- 6 Press the number buttons to enter the new password again, to confirm.

Caution
Write down your password and save it for future use.

Note
If you forget your password, enter **0000** for the old password, then enter a new password. This password always remains valid for resetting your password.

Setting the Parental Control level

To set the Parental Control level:

- 1 Press **MENU** on the TV or remote control, then press **VOL-** or **VOL+** to select the *FUNCTION* menu. The *FUNCTION* menu opens.

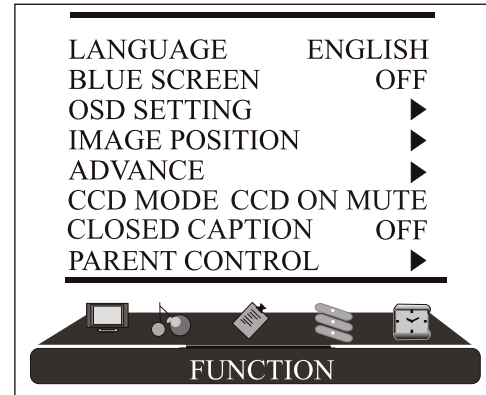

- 2 **CH-** or **CH+** to select **PARENT CONTROL**, then press **VOL-** or **VOL+**. The *Password box* opens.



- 3 Press the number buttons to enter **0000** (the default initial password). The *PARENT CONTROL* menu opens.

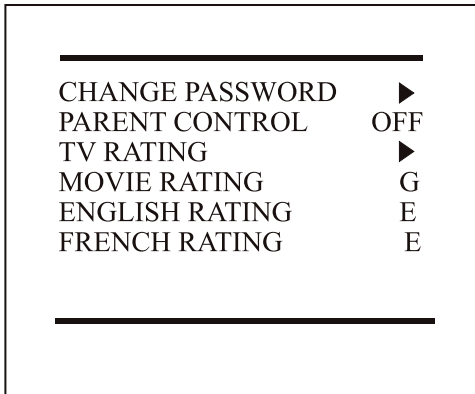

- 4 **CH-** or **CH+** to select the option you want to set, then press **VOL-** or **VOL+** to change the setting.

- 5 Press **MENU** to close the menu.

TV Parental Guidelines ratings

Rating	Description
NONE or NR	Not rated.
TV-Y	All children.
TV-Y7	Children over seven years of age.
TV-G	General audiences.
TV-PG	Parental guidance suggested.
TV-14	Parents strongly cautioned.
TV-MA	Mature audiences only.

Some of the age-based TV Parental Guidelines ratings also have PG Content-based ratings.

Rating	Description
FV	FANTASY VIOLENCE.
D	DIALOG
L	LANGUAGE.
S	SEX
V	VIOLENCE.

American MPAA (Movie) ratings

Rating	Description
NONE or NR	Not rated.
G	General audiences.
PG	Parental guidance suggested. Some material may not be suitable for children.
PG 13	Parental guidance strongly suggested. Some material may not be suitable for children under 13 years of age.
R	Restricted. Not suitable for children under 17 years of age unless accompanied by a parent or guardian.
NC 17	Not suitable for children under 17 years of age.
X	Adults only.

Canadian MPAA (Movie) ratings

Rating	Description
E	Exempt - includes news, sports, documentaries, talk shows.
C*	Children (English)
G**	Children (French)
8+**	Children 8 years and above (French)
C8+*	Children 8 years and above (English)
G*	General audience (English)
PG	Parental guidance suggested.
13+**	13 years old and above (French)
14+*	14 years old and above (English)
16+**	16 years old and above (French)
18+	Adult programming
OFF	No controls

* Can. English only

** Can. French only

Using the DVD player (NS-CL26C only)

Playing a DVD

To play a DVD:

- 1 Press **POWER** to turn on the TV.
- 2 Press **TV/DVD** to select **DVD**.
- 3 Press **▲ OPEN/CLOSE** to open the disc tray.

- 4 Place the DVD in the disc tray, then press **▲ OPEN/CLOSE** to close the disc tray. The DVD player reads the DVD and displays the opening menu.
- 5 Press the **▲** and **▼** buttons to highlight menu items, and **PLAY/ENTER** on the remote, to select.
- 6 Press **PLAY/ENTER** to begin playback.
- 7 During playback:
 - Press **II PAUSE/STEP** on the remote to pause playback. Press **II PAUSE/STEP** on the remote again to resume playback.
 - Press **◀◀** to fast review, and press **▶▶** to fast forward. Each time you press the fast reverse or fast forward button, the speed changes.
 - Press **◀◀◀** to skip to the beginning of the current chapter, and press **▶▶▶** to skip to the next chapter. Press repeatedly to continue skipping back or forward.
 - To advance a movie frame by frame, press **PAUSE/STEP** button, then press again. Each time you press the **II PAUSE/STEP** button, the movie advances by one frame.
 - Press the **SLOW** button to play the disc in slow motion, then press **PLAY/ENTER** to resume normal playback.
 - To search for a specific scene, press **SEARCH** to open the **SEARCH** menu, then press the **▲ ▼** button to select the item you want (for DIVX, CD, or MP3 press the **SEARCH** button several times to select the item you want). Press the number buttons or navigation buttons to indicate the scene you want, then press **ENTER** to confirm.
 - Press the **■ (stop)** button to stop playback. Press **PLAY/ENTER** to resume normal playback. To completely stop DVD playback, press **■ (stop)** twice.
- 8 Press **▲ OPEN/CLOSE** to remove the DVD.

Accessing the root DVD menu

To access the root DVD menu:

- 1 Press **DVD MENU** on the remote control.
- 2 Select and change the options you want.

Note

This function is not available on DVDs with multi-layer menus.

Displaying DVD information

To display DVD information:

- Press **DISPLAY** on the remote control repeatedly to cycle through *Title Elapsed*, *Title Remain*, *Chapter Elapsed*, *Chapter Remain*, and *Display Off*.

Selecting the subtitle language

If the DVD was created with subtitles, you can change the subtitle language.

To change the subtitle language:

- 1 Press **SUBTITLE** repeatedly until the desired language is selected.

- To remove subtitles, press **SUBTITLE** until "Off" appears on the screen.

Note

Changing the subtitle language using this method only affects the DVD currently being played. When the DVD is removed or the player is turned off, the subtitle language reverts to the language setting specified through the DVD player's main menu.

Tip

The subtitle language can also be changed through the DVD player's main menu or the DVD's own subtitle settings.

Using repeat play

You can repeat chapters, titles, or the entire DVD using Repeat play.

Note

Other options are available for CD, MP3, or DIVX discs.

To repeat a segment:

- While a DVD is playing, press **REPEAT** to scroll through the options:
 - Chapter** (repeats the current chapter)
 - Title** (repeats the current title)
 - All** (repeats all content on the DVD)
- To stop repeat playback, do one of the following:
 - Press **REPEAT** until "ALL" disappears from the screen.
 - Press **STOP** twice.
 - Eject the DVD.

To repeat selected parts of a DVD:

- Set a starting point by pressing **A-B**.
- Set an end point by pressing **A-B** again.
- The player plays from point A to point B.
- To stop the repeat function, press **A-B** again.

Changing the camera angle

Some DVDs contain multiple angles of a scene or sequence. If the DVD has only one angle, this feature does not work.

To change the camera angle:

- Press **ANGLE** repeatedly until the desired camera angle is selected.
- To resume normal playback, press **ANGLE** until the original angle is selected.

Magnifying the image

You can enlarge or reduce the display image while the DVD is playing or while it is paused.

To magnify the image:

- While a DVD is playing, press **ZOOM**. The image is magnified 2x. Continue pressing **ZOOM** to magnify the image 3x, then 4x.
 - While the image is magnified, press the **▲ ▼** and **◀ ▶** buttons to move the picture on the screen.
- To return to normal picture size, press **ZOOM** until the picture returns to normal.

Program play

To play chapters and titles in a custom order, you can create a playback program.

To program playback:

- Press **PROGRAM** while a disc is playing to enter Program mode.
- Press the number buttons on the remote control to enter the title and chapter you want to play first. The title and chapter number you entered appears in the box.
- The cursor jumps to the next spot in the program list section. Make sure the box is highlighted and enter your next title and chapter.
- Continue adding titles and chapters until your program is finished.
- Highlight **START**, then press **PLAY/ENTER** to start playing the program.
- To stop the programmed playback, press **■ STOP** twice during program play.

Changing the audio options

If the DVD was created with multiple language tracks (recorded in different languages), or multiple sound options, you can temporarily change the DVD player's Audio settings.

To change the audio options:

- Press **AUDIO**. The OSD shows the current audio setting.
- If multiple audio options are available, press **AUDIO** again to select the next audio track.

Note

This feature only works if the DVD was created with multiple audio tracks. When you choose an audio language, you only temporarily override the audio language setting in the DVD player's main menu.

Allow a three second interval between selections.

Tip

The audio language can also be changed through the DVD player's main menu or the DVD's own audio settings.

Playing a CD**To play a CD:**

- Press **POWER** to turn on the player.
- Press **TV/DVD** to select DVD.
- Press **▲ OPEN/CLOSE** to open the disc tray.
- Place the CD in the disc tray, then press **▲ OPEN/CLOSE** to close the disc tray. The DVD player begins playing the CD.
- Press **PLAY/ENTER** to begin playback.
- During playback:
 - Press **II PAUSE/STEP** on the remote to pause playback. Press **II PAUSE/STEP** on the remote again to resume playback.
 - Press **◀◀** to fast review, and press **▶▶** to fast forward.
 - Press **◀◀** to skip to the previous track, and press **▶▶** to skip to the next track. Press repeatedly to continue skipping back or forward.
 - To completely stop CD playback, press **■ (stop)**.
- Press **▲ OPEN/CLOSE** to remove the CD.

Using repeat play

You can repeat tracks or the entire CD using repeat play.

To use repeat play:

- 1 While the CD is playing, press **REPEAT** to scroll through the options:
 - Single - (play current track)
 - Repeat One - (repeat current track)
 - Repeat Folder - (repeat current folder)
 - Folder - (play current folder)
- 2 To stop repeat playback, do one of the following:
 - Press **REPEAT** until "Folder" disappears from the screen.
 - Press **STOP** twice.
 - Eject the CD.

Changing the audio mode

To change the audio output of a multi-channel CD:

- During CD playback, press **AUDIO**. The setting changes each time you press the button:
 - Mono Left
 - Mono Right
 - Mix-Mono
 - Stereo

Selecting a track for playback

To select a specific track for playback:

- After you load a CD into the player, and after the player finishes reading the disc, press the number buttons to enter the track number, then press **PLAY/ENTER** to play the track.

Tip

If the track number is under 10, press buttons **1-9** to select it. If the track number is 10, press **10+** once, then button **0** to select it. If the track number is over 10, press **10+** once, then a button **1-9**.

Playing a Kodak picture CD or JPEG disc

To play a Kodak picture CD or JPEG disc:

- 1 Press **POWER** to turn on the player.
- 2 Press **TV/DVD** to select DVD.
- 3 Press **OPEN/CLOSE** to open the disc tray.
- 4 Place the disc in the disc tray, then press **OPEN/CLOSE** to close the disc tray. The disc navigation menu opens.
- 5 Press **▲ ▼** to select the file you want, then press **PLAY/ENTER** to confirm. The slideshow begins.
- 6 During playback:
 - Press **II PAUSE/STEP** on the remote, to stop the picture and press **PLAY/ENTER** resume normal play.
 - Press **◀◀** to skip to the previous track, and press **▶▶** to skip to the next track. Press repeatedly to continue skipping back or forward.

- To completely stop disc playback, press **STOP** twice.

- 7 Press **OPEN/CLOSE** to remove the disc.

Magnifying the image

You can enlarge or reduce the display image while the disc is playing or while it is paused.

To magnify the image:

- 1 While a disc is playing, press **ZOOM**. The image is magnified 2x. Continue pressing **ZOOM** to magnify the image 3x, then 4x.
 - While the image is magnified, press the **▲ ▼** and **◀ ▶** buttons to move the picture on the screen.
- 2 To return to normal picture size, press **ZOOM** until the picture returns to normal.

Playing an MP3 disc

To play a MP4 disc:

- 1 Press **POWER** to turn on the player.
- 2 Press **TV/DVD** to select DVD.
- 3 Press **OPEN/CLOSE** to open the disc tray.
- 4 Place the disc in the disc tray, then press **OPEN/CLOSE** to close the disc tray. The disc navigation menu opens.
- 5 Press **▲ ▼** to select the folder you want, then press **PLAY/ENTER** to enter the folder.
- 6 Press **▲ ▼** to select the file you want, then press **PLAY/ENTER** to see the file.
- 7 Press **◀** to go to the previous menu.

Note

This DVD player plays most MPEG4 encoded discs, but some discs with the MPEG4 logo are not encoded by MPEG technology and will not play well in this player.

Customizing TV settings

Opening and navigating the on-screen menus

Using the on-screen menu

Your TV has an on-screen menu system that lets you adjust TV settings, such as video and audio settings.

To use the on-screen menu:

- 1 Press **MENU** on the TV or remote control, then press **VOL-** or **VOL+** to access the menu you want.
- 2 Press **CH-** or **CH+** to select the menu item, then press **VOL-** or **VOL+** to adjust/change that item or go to the sub-menu for that item.
- 3 Press **MENU** to close the on-screen menu.

On-screen menus

On-screen menu	Options
TUNER	<p>CH.SOURCE—Selects the TV antenna source (AIR or CATV).</p> <p>CH.NUM.—The current channel selected. Press CH+/CH- to change the setting.</p> <p>SKIP—Setting this to ON causes the current channel (see CHANNEL above) to be skipped on the channel list. You can select a skipped channel by inputting the channel number using the number buttons.</p> <p>FINE TUNE—Use to manually adjust tuning to improve image and sound quality. Do not use unless reception is poor.</p> <p>AUTO SCAN—Automatically sets up a list of the channels available in your area for the antenna type selected. For more information, see “Programming channels into memory” on page 9.</p> <p>EDIT PROGRAM—Lets you rename, skip, delete, or copy a channel.</p>
PICTURE	<p>PICTURE MODE—Lets you select one of four preset picture modes, including STANDARD, SOFT, USER, or BRIGHT.</p> <p>CONTRAST—Increases the picture level to adjust the white areas of the picture. Decreases the picture level to adjust the black areas of the picture. (0 ~ 100)</p> <p>BRIGHTNESS—Increases the brightness to add more light to dark areas of the picture. Decreases the brightness to add more dark to light areas of the picture. (0 ~ 100)</p> <p>TINT—Change settings from green (0) to red (100).</p> <p>COLOR (saturation)—Lets you increase or decrease the color saturation of the picture. (0 ~ 100)</p> <p>SHARPNESS—Increases the sharpness for a cleaner and clearer image. Decreases the sharpness for a smoother picture. (0~100)</p> <p>COLOR TEMP—Adjusts the overall color of the picture. (NORMAL, COOL, COOLER, WARMER, or WARM)</p> <p>ZOOM—Lets you choose the picture size. (ZOOM, CINEMA, WIDE, or NORMAL).</p>
SOUND	<p>SOUND—Selects an audio equalization mode for the TV sound (STANDARD, NEWS, USER, or MUSIC)</p> <p>BALANCE—Adjusts the right and left speaker volumes.</p> <p>AVC—Automatic Volume Control. Reduces the effect of high volume by limiting volume peaks across all channels.</p> <p>EQUALIZER—Lets you change the sound equalizer settings.</p> <p>SURROUND—Lets you select a preset surround sound setting. (ROOM, THEATER, OFF, or VALLEY)</p> <p>DIGITAL BASS—Lets you turn digital bass on or off to adjust the low sounds (bass).</p>

On-screen menu	Options
FUNCTION	<p>LANGUAGE—Selects the language for the on-screen display (OSD).</p> <p>BLUE SCREEN—Sets the option to turn on the blue screen if there is no signal for three seconds.</p> <p>OSD SETTING—Lets you set the duration and opacity of the on-screen display.</p> <p>IMAGE POSITION—Lets you adjust the horizontal and vertical position of the picture. In VGA mode you can adjust the phase of the PC image to remove horizontal distortion and sharpen characters and adjust the LCD to match the PC input source clock frequency.</p> <p>ADVANCE—Lets you adjust the quality and expressive force of the image. Available options include:</p> <ul style="list-style-type: none"> • AAA—Presets to change the brightness, contrast, and arrangement of the image. (ON, SPLIT, MOVE, and ZOOM) • CTI—Turn this on to restrain color bleed over from one image to another. • LTI—Turn this on to optimize the brightness of the image. • DLC—Turn this on to optimize the depth of the image. • SKIN—Turn this on to optimize the skin tones of the image. • DNR—Set this to control image noise. (OFF, WEAK, MEDIUM, and STRONG) <p>CCD MODE—Selects the CCD Mode. Options include:</p> <ul style="list-style-type: none"> • CCD ON MUTE • ON • OFF <p>CLOSED CAPTION—Selects the Closed Caption type for viewing.</p> <ul style="list-style-type: none"> • OFF—Turns off Closed Captioning • CC1—Turns on Closed Captioning in the primary language of your area • CC2-CC4—Turns on other modes of video-related broadcast information in a secondary language. • Text1—Turns on the program guide provided by broadcasters. • Text2-Text4—Turns on other types of information provided by broadcasters. <p>PARENTAL CONTROL—Accesses V-chip controls. For more information, see “Setting parental controls” on page 10.</p>
TIMER	<p>SLEEP TIMER—Lets you set the sleep timer to turn off the TV after a preselected interval.</p> <p>CLOCK—Lets you set the clock, which is shown when the DISPLAY button is pressed.</p> <p>TIME OFF—Lets you set a specific time for the TV to turn off.</p> <p>BOOK TIME—Lets you set a specific time to watch a program.</p> <p>BOOK CHAN.—Lets you set a specific channel to watch in the Book Time you set.</p>

Customizing DVD player settings

Using the setup menu

Use your remote control to navigate the setup menu, where you can configure DVD player settings.

To open and navigate the Setup menu:

- 1 Press **SETUP** on the remote control. The *General Setup Page* opens.

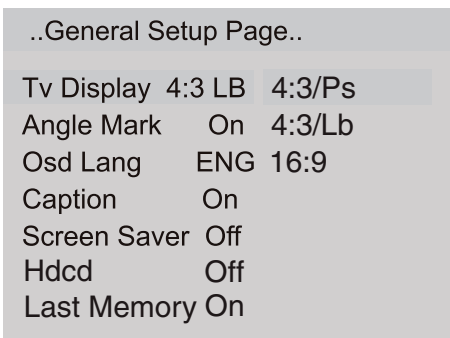

- 2 Press **SETUP** again. The *Preference Page* opens.

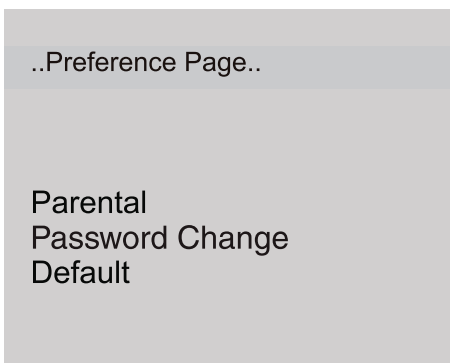

- 3 Press **▲ ▼** to highlight a selection or submenu, then press **▶** to enter the submenu or show the options available.
- 4 Press **▲ ▼** to select the option/setting you want, then press **PLAY/ENTER** to confirm.
- 5 To exit the *Setup* menu, press **SETUP**.

Changing DVD settings

On-screen menu	Options
GENERAL SETUP	<p>TV DISPLAY—Sets the aspect ratio of the TV display.</p> <ul style="list-style-type: none"> • 4:3/PS (Pan and Scan - may be used with external TVs) Widescreen images are shown on the screen, but with some parts automatically cut off the ends. • 4:3/LB (Letter Box - use with internal TV) Widescreen images are shown on the screen with black bars on the top and bottom of the screen. • 16:9 (may be used with external TVs) Widescreen images fill the entire screen. <p>ANGLE MARK—Lets you turn the Angle option On or Off. If you set this to On, you can use the ANGLE button on the remote to select an alternate viewing angle on the DVD.</p> <p>OSD Lang.—Lets you select the language for the On Screen Display (OSD).</p> <p>CAPTION—Lets you turn the caption On or Off.</p> <p>SCREEN SAVER—Lets you turn on the screen saver, which displays when the DVD player is idle for more than three minutes.</p> <p>Hdcd—Lets you set Hdcd to "OFF", "1X", "2X" to switch the CD play mode between "Normal CD", "HDCD with 44.1K", "HDCD with 88.2K". You can play normal CDs when "HDCD" is set to off. You can play 44.1K CDs when HDCD is set to 1X, and 88.2K CDs when HDCD is set to 2X to enhance the audio quality.</p> <p>Last Memory—Lets you turn the last memory option On or Off. When set to On, the DVD player remembers the chapter that you were viewing when you turn the DVD player off and starts the DVD at that chapter when you turn the DVD player back on.</p>
PREFERENCE (only available when no disc is in the player)	<p>TV TYPE—Lets you select the TV output type. Options include:</p> <ul style="list-style-type: none"> • MULTI (Auto)—Set to this option • NTSC • PAL <p>PARENTAL—Lets you set Parental Controls for watching DVDs. Initial password is 1234</p> <p>Options include:</p> <ul style="list-style-type: none"> • Off • 1 Kid Safe • 2 g • 3 Pg • 4 Pg 13 • 5 Pgr • 6 R • 7 Nc 17 • 8 Adult <p>PASSWORD CHANGE—Lets you change the password used to set or change Parental Controls. The initial password is 1234. Use the number buttons to enter, then confirm the new password.</p> <p>Note: If you forget your password, enter 1369.</p> <p>DEFAULT—Resets all settings (except Parental Controls and the password) to factory default. Press ENTER to confirm.</p>

Troubleshooting

Please check the following items before calling for service:

Problem	Solution
No picture or sound.	Check all cable connections. Make sure that the TV is plugged in and turned on. Make sure that electricity is available at the AC power outlet.
Picture is OK, but no sound.	Check the volume level and mute settings. Switch to another channel to determine if the station is the problem.
No picture	Make sure that the TV is working properly. Press the INPUT button to select TV input. Make sure the color system is set correctly.
Sound is OK, but no color.	Check the color control and adjust it. Check the program's color features, because it may be a black and white movie.
The picture has overlapped images.	Make sure that the antenna is installed correctly. If not, adjust the antenna toward the broadcasting station.
Picture has "snow."	Check the antenna and its connection. If there are problems, correct them. If all connections are tight, the problem may be with a faulty antenna or cable. Check whether car traffic or neon signs disturb the image.
Stripes on picture.	Check for interference from other electronic devices, such as radios and televisions, and keep magnetic or electronic devices away from the TV.
Remote control does not work.	Change the batteries in the remote control. Remove any obstacles between the TV's IR sensor and the remote control.
Image is not clear.	In VGA mode, adjust the PHASE control.
Image is not centered.	Adjust the Horizontal or Vertical control.
Bad sound quality	Make sure that the audio output mode is set correctly. Make sure that the audio connection between the unit and amplifier (if used) is secure.
The TV doesn't operate normally	Disconnect the power plug for ten seconds, then reconnect it. If the problem persists, contact Insignia or your dealer for help.

Notes

- If the problem is not fixed after you check the above items, do not attempt to remove the back cover by yourself.
- You may hear a snapping sound from the TV occasionally. This is normal and is caused by temperature changes in the operating environment and does not affect the operation of the TV.
- Do not let the TV remain on static images for long periods of time because it can result in permanent residual images on the screen. If this situation occurs, the TV may recover automatically after 12 hours if you change to dynamic programming.

Maintaining

Handling and cleaning the TV

Shipping the TV

Please save the original shipping carton and packing materials. If you need to ship the TV, for maximum protection, re-pack the it as it was originally packed at the factory.

Keeping the exterior surfaces clean

- Do not use volatile liquids such as insecticide spray near the TV.
- Do not leave rubber or plastic products in contact with the TV for a long period of time because they can leave marks on the surface.

Cleaning the case

- To clean the player, use a soft, dry cloth. If the surfaces are extremely dirty, use a soft cloth lightly moistened with a mild detergent solution.
- Do not use strong solvents such as alcohol, benzene, or thinner, as these might damage the surface of the player.

Maintaining the TV

This TV is a high-tech, precision device. If the optical pick-up lens and disc drive parts are dirty or worn, the picture quality could be diminished. Depending on the operating environment, regular inspection and maintenance are recommended after every 1,000 hours of use. For details, please contact your nearest authorized service center.

Care and handling of discs

Handling discs

Do not touch the playback side of the disc. Hold the disc by the edges so that fingerprints do not get on the surface. Never stick paper or tape on the disc.

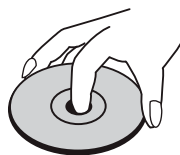

Storing discs

After playing, store the disc in its case. Do not expose the disc to direct sunlight or sources of heat and never leave it in a parked car exposed to direct sunlight.

Cleaning discs

Fingerprints and dust on the disc can cause poor picture quality and sound distortion. Before playing, clean the disc with a clean cloth. Wipe the disc from the center out.

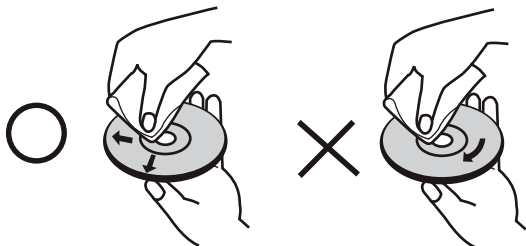

Do not use strong solvents such as alcohol, benzine, thinner, commercially available cleaners, or anti-static spray intended for older vinyl records.

Note

Never operate this product immediately after moving it from a cold location to a warm location. Leave it for two or three hours without operating it. If you use this product in such a situation, it may damage tapes, discs, or internal parts.

Discs	Label	Contents	Dimension
CD		Audio	12 cm
MPEG-4		Audio + Video (moving picture)	12 cm
JPEG		Video (picture)	12 cm
KODAK CD		Video (picture)	12 cm
CD-R	CD•R	Audio or Video (moving picture)	12 cm
CD-RW	CD-RW	Audio or Video (moving picture)	12 cm
CD+G	CD+G	Audio (picture)	12 cm

Legal Notices

Copyright

© 2007 Insignia. Insignia and the Insignia logo are trademarks of Best Buy Enterprise Services, Inc. Other brands and product names are trademarks or registered trademarks of their respective holders. Specifications and features are subject to change without notice or obligation.

For service and support call (877) 467-4289.

Specifications

Model	NS-LCD26F/NS-LCD32F/NS-CL26C
Screen type	A-si TFT active matrix
Viewable angle	160° H and 150° V - NS-LCD26F and NS-CL26C 170° H and 170° V - NS-LCD32F
Picture and sound system	NTSC (AV) Mono
Video input	CVBS, S-VIDEO, YPb/Pr, YCb/Cr, VGA, HDMI
YPb/Pr	Composite, 480i/p, 576i, 720p, 1080i, 1080p
Power	See rating plate on TV
Power consumption	See rating plate on TV
Dimensions (WxDxH)	26.8 × 8.6 × 20.6 inches (68.1 × 22.0 × 52.3 cm) - NS-LCD26F and NS-CL26C 32 × 10 × 24.2 inches (81.3 × 25.5 × 61.4 cm) - NS-LCD32F
Environmental	Working temp: 41° F~95° F (+5° C~+35° C) Working humidity: 20%-80% Storage temp: 5° F~113° F (-15° C~+45° C) Storage humidity: 5%-90%
Accessories	Remote control Batteries (two - AA) User Guide Power cord

Playable discs

The following discs, and only the following discs, can be played in the DVD player.

Discs	Label	Contents	Dimension
DVD		Audio + Video (moving picture)	12 cm

1 Year Limited Warranty

Insignia Products ("Insignia") warrants to you, the original purchaser of this new LCD TV ("Product"), that the Product shall be free of defects in the original manufacture of the material or workmanship for a period of one (1) year from the date of your purchase of the Product ("Warranty Period"). This Product must be purchased from an authorized dealer of Insignia brand products and packaged with this warranty statement. This warranty does not cover refurbished Product. If you notify Insignia during the Warranty Period of a defect covered by this warranty that requires service, terms of this warranty apply.

HOW LONG DOES THE COVERAGE LAST?

The Warranty Period lasts for 1 year (365 days) from the date you purchased the Product. The purchase date is printed on the receipt you received with the Product.

WHAT DOES THIS WARRANTY COVER?

During the Warranty Period, if the original manufacture of the material or workmanship of the Product is determined to be defective by an authorized Insignia repair center or store personnel, Insignia will (at its sole option): (1) repair the Product with new or rebuilt parts; or (2) replace the Product at no charge with new or rebuilt comparable products or parts. Products and parts replaced under this warranty become the property of Insignia and are not returned to you. If service of Products or parts are required after the Warranty Period expires, you must pay all labor and parts charges. This warranty lasts as long as you own your Insignia Product during the Warranty Period. Warranty coverage terminates if you sell or otherwise transfer the Product.

HOW TO OBTAIN WARRANTY SERVICE?

If you purchased the Product at a retail store location, take your original receipt and the Product to the store you purchased it from. Make sure that you place the Product in its original packaging or packaging that provides the same amount of protection as the original packaging. If you purchased the Product from an online web site, mail your original receipt and the Product to the address listed on the web site. Make sure that you put the Product in its original packaging or packaging that provides the same amount of protection as the original packaging.

To obtain in-home warranty service for a television with a screen 25 inches or larger, call 1-888-BESTBUY. Call agents will diagnose and correct the issue over the phone or will have an Insignia-approved repair person dispatched to your home.

WHERE IS THE WARRANTY VALID?

This warranty is valid only to the original purchaser of the product in the United States and Canada.

WHAT DOES THE WARRANTY NOT COVER?

This warranty does not cover:

- Customer instruction
- Installation
- Set up adjustments
- Cosmetic damage
- Damage due to acts of God, such as lightning strikes
- Accident
- Misuse
- Abuse
- Negligence
- Commercial use
- Modification of any part of the Product, including the antenna
- Plasma display panel damaged by static (non-moving) images applied for lengthy periods (burn-in).

This warranty also does not cover:

- Damage due to incorrect operation or maintenance
- Connection to an incorrect voltage supply
- Attempted repair by anyone other than a facility authorized by Insignia to service the Product
- Products sold as is or with all faults
- Consumables, such as fuses or batteries

- Products where the factory applied serial number has been altered or removed

REPAIR REPLACEMENT AS PROVIDED UNDER THIS WARRANTY IS YOUR EXCLUSIVE REMEDY. INSIGNIA SHALL NOT BE LIABLE FOR ANY INCIDENTAL OR CONSEQUENTIAL DAMAGES FOR THE BREACH OF ANY EXPRESS OR IMPLIED WARRANTY ON THIS PRODUCT, INCLUDING, BUT NOT LIMITED TO, LOST DATA, LOSS OF USE OF YOUR PRODUCT, LOST BUSINESS OR LOST PROFITS. INSIGNIA PRODUCTS MAKES NO OTHER EXPRESS WARRANTIES WITH RESPECT TO THE PRODUCT, ALL EXPRESS AND IMPLIED WARRANTIES FOR THE PRODUCT, INCLUDING, BUT NOT LIMITED TO, ANY IMPLIED WARRANTIES OF AND CONDITIONS OF MERCHANTABILITY AND FITNESS FOR A PARTICULAR PURPOSE, ARE LIMITED IN DURATION TO THE WARRANTY PERIOD SET FORTH ABOVE AND NO WARRANTIES, WHETHER EXPRESS OR IMPLIED, WILL APPLY AFTER THE WARRANTY PERIOD. SOME STATES, PROVINCES AND JURISDICTIONS DO NOT ALLOW LIMITATIONS ON HOW LONG AN IMPLIED WARRANTY LASTS, SO THE ABOVE LIMITATION MAY NOT APPLY TO YOU. THIS WARRANTY GIVES YOU SPECIFIC LEGAL RIGHTS, AND YOU MAY ALSO HAVE OTHER RIGHTS, WHICH VARY FROM STATE TO STATE OR PROVINCE TO PROVINCE.

Contact Insignia:

For customer service please call 1-877-467-4289

www.insignia-products.com

INSIGNIA™ is a trademark of Best Buy Enterprise Services, Inc.

Distributed by Best Buy Purchasing, LLC.

Insignia, 7601 Penn Avenue South, Richfield, Minnesota, U.S.A.



Distributed by Insignia™ Products
Distribué par Insignia™ Products
Distribuido por Insignia™ Products

7601 Penn Avenue South,
Richfield, MN USA 55423-3645
www.Insignia-Products.com

©2007 Insignia™ Products

All rights reserved. All other products and brand names are trademarks of their respective owners.

©2007 produits Insignia™

Tous droits réservés. Tous les autres produits ou noms de marques sont des marques de commerce qui appartiennent à leurs propriétaires respectifs.

©2007 productos Insignia™

Todos los derechos reservados. Todos los demás productos y marcas son marcas comerciales de sus respectivos dueños.

Download from www.Somanuals.com. All Manuals Search And Download.

Free Manuals Download Website

<http://myh66.com>

<http://usermanuals.us>

<http://www.somanuals.com>

<http://www.4manuals.cc>

<http://www.manual-lib.com>

<http://www.404manual.com>

<http://www.luxmanual.com>

<http://aubethermostatmanual.com>

Golf course search by state

<http://golfingnear.com>

Email search by domain

<http://emailbydomain.com>

Auto manuals search

<http://auto.somanuals.com>

TV manuals search

<http://tv.somanuals.com>