



# USER GUIDE

INSIGNIA™

## Portable CD Player with FM

NS-P5113

Before using your new product, please read these instructions to prevent any damage.

INSIGNIA™

# Insignia NS-P5113 Portable CD Player with FM

## Contents

Safety information . . . . .	2
Features . . . . .	5
Setting up your CD player . . . . .	6
Using your CD player . . . . .	8
Troubleshooting . . . . .	13
Maintaining . . . . .	14
Specifications . . . . .	15
Legal notices . . . . .	16
ONE-YEAR LIMITED WARRANTY - INSIGNIA . . . . .	17

## Safety information

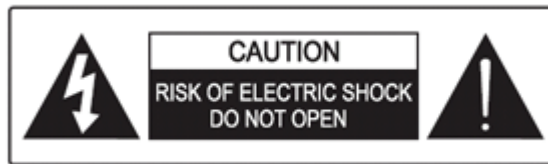

### Warning

To reduce the risk of electric shock, do not remove the cover or back. There are no user-serviceable parts inside. Refer all servicing to qualified service personnel.

	The lightning flash with the arrowhead inside an equilateral triangle is intended to alert you to the presence of un-insulated, dangerous voltage within your CD player's enclosure. This voltage may be of sufficient magnitude to constitute a risk of electrical shock.
---	--

	The exclamation point within an equilateral triangle is intended to alert you to the presence of important operating and maintenance (servicing) instructions in the literature accompanying your CD player.
---	--

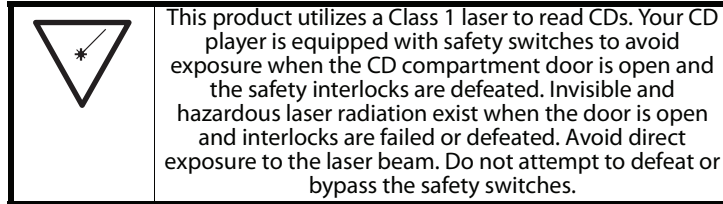

### Important safety information

- The apparatus and AC adapter shall not be exposed to dripping or splashing and no objects filled with liquids, such as vases, shall be placed on the apparatus.
- To completely disconnect the apparatus from the mains power, the mains plug of the AC adapter shall be disconnected from the mains outlet.
- The mains plug of the AC adapter should not be obstructed OR should be easily accessed during intended use.
- Excessively high sound pressure could harm or damage hearing.
- Battery shall not be exposed to excessive heat such as sunshine, fire or the like.
- Minimum distances of 4 inches (10 cm) around the apparatus and AC adapter shall be available for sufficient ventilation.
- The ventilation should not be impeded by covering the ventilation openings with items such as newspapers, tablecloths, curtains, etc.
- No naked flame sources such as lighted candles should be placed on the apparatus and AC adapter.
- Attention should be drawn to the environmental aspects of battery disposal.
- The apparatus and AC adapter should be used in moderate climates.

### Surge protectors:

We recommend that you use a surge protector when you connect your CD player to AC power. A surge protector will help protect your CD player from lightning and power surges, which are not covered by your warranty.

### Follow these safety precautions:

- Read and retain all instructions.
- Do not open the CD door while the CD is spinning.
- Always keep the CD door closed when not in use.
- Keep all foreign objects out of the CD compartment.
- Place your CD player on a stable surface.
- Avoid installing your CD player in any of the following locations:

# INSIGNIA™

---

Insignia NS-P5113 Portable CD Player with FM

- Places exposed to direct sunlight or close to heat radiating appliances, such as electric heaters.
- On top of other stereo equipment that radiates too much heat.
- Places that lack correct ventilation or dusty places.
- Places subject to constant vibration.
- Humid or moist places.

**Caution**

Do not expose your CD player to dripping or splashing and do not set objects filled with liquid, such as vases, on top of your CD player.

## Package contents:

- Portable CD Player with FM
- 2 AA batteries
- *User Guide*
- Headphone

## Features

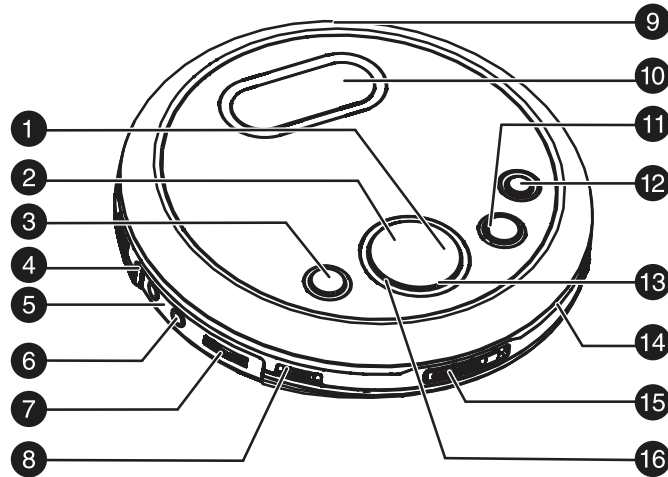

#	Item	Description
1		<ul style="list-style-type: none"> <li>When playing an audio CD, press to skip or fast-search forward.</li> <li>When playing an MP3 CD (in menu mode), press to search right.</li> <li>When playing the radio, press to tune to a higher frequency station.</li> </ul>
2		<ul style="list-style-type: none"> <li>When playing an audio CD or MP3 CD, press to start or pause playback.</li> <li>When playing an MP3 CD (in menu mode), press to search up.</li> </ul>
3	PLAY MODE	Press to select the playback mode. You can select <b>REPEAT1</b> , <b>ALL</b> , <b>DIR.</b> , <b>INTRO</b> , or <b>RANDOM</b> .
4	Hold switch	Slide to lock button controls so you do not accidentally press a button.
5	LINE OUT jack	Plug an audio cable into this jack and into the CD/AUX jack on an external audio system.
6	PHONE jack	Plug headphones into this jack.
7	Volume control switch	Slide to adjust the volume.
8	DBBS switch	Slide to the <b>ON</b> position to turn on bass boost. Slide to the <b>OFF</b> position to turn off bass boost.
9	DC INPUT jack	Plug the AC/DC power adapter (not supplied) into this jack and into an AC outlet.
10	LCD display	Displays information about the currently playing disc and various functions of your CD player.
11	MEMORY/ENTER	When playing the radio, press to store the station in memory.

INSIGNIA™

Insignia NS-P5113 Portable CD Player with FM

#	Item	Description
12	MENU/ESP/PRESET	<ul style="list-style-type: none"> <li>When playing an audio CD, press to turn the anti-shock feature on or off.</li> <li>When playing an MP3 CD, press to start the search function.</li> </ul>
13	■ / ▼ / POWER OFF	<ul style="list-style-type: none"> <li>Press to stop audio CD playback.</li> <li>When playing an MP3 CD (in menu mode), press to search down.</li> <li>Press and hold to turn off your CD player.</li> </ul>
14	FUNCTION	Slide to select CD or radio mode.
15	OPEN switch	Press to open the CD compartment door.
16	◀◀ / ▶	<ul style="list-style-type: none"> <li>When playing an audio CD, press to skip or fast-search backward.</li> <li>When playing an MP3 CD (in menu mode), press to search left.</li> <li>When playing the radio, press to tune to a lower frequency station.</li> </ul>

## Setting up your CD player

### Installing batteries

#### To install batteries:

- 1 Lift the battery compartment door on the bottom of your CD player. Do not remove the door.
- 2 Insert two AA alkaline batteries into the battery compartment. Make sure that the + and – symbols on the batteries match the + and – symbols inside the battery compartment.
- 3 Close the battery compartment door.

#### Caution

Use only the size and type of batteries specified. Make sure that you match the + and – symbols on the batteries with the + and – symbols inside the battery compartment. If you insert the batteries backwards, your CD player may be damaged.

Do not mix different types of batteries together (such as, alkaline, rechargeable, and carbon/zinc). Do not mix old batteries and new batteries.

When you do not plan to use your CD player for a long period of time, remove the batteries to prevent damage or injury from possible battery leakage.

Do not try to recharge batteries not intended to be recharged. They can overheat and rupture.

Insignia NS-P5113 Portable CD Player with FM

INSIGNIA™

**Note**

If the symbol "LOW BATTERY" appears on the display, batteries are weak and should be replaced.

## Using the AC/DC power adapter (not supplied)

**To use the AC/DC power adapter:**

- 1 Plug one end of the AC/DC power adapter (not supplied) into the **DC INPUT** jack on the back of your CD player.
- 2 Plug the other end of the AC/DC power adapter into a AC outlet.

**Notes**

The AC/DC power adapter (not supplied) is an optional accessory.  
If the AC adapter is connected when regular batteries are installed, the power supply automatically switches to the AC power source.  
Use only the optional AC/DC power adapter.  
Make sure that the AC/DC power adapter matches with your household voltage before connecting it into an outlet.  
When you are not using AC power, unplug the AC/DC power adapter.  
Do not touch the AC/DC power adapter with wet hands when it is connected to AC power.

## Connecting to an external audio system

**To connect your CD player to an external audio system:**

- 1 Make sure that your CD player is turned off and unplugged (if you are using the AC/DC power adapter).
- 2 Plug one end of an audio cable into the **LINE OUT** jack on your CD player.
- 3 Plug the other end of the audio cable into the **CD/AUX** jack on the external audio system. Do not plug the cable into an amplifier **PHONE** jack.

## Connecting the headphones

**To connect the headphones directly to the CD player:**

- Plug the headphone cable into the **PHONE** jack on your CD player.

# INSIGNIA™

Insignia NS-P5113 Portable CD Player with FM

## Using your CD player

### Playing a CD

#### Caution

Your CD player is designed to play audio CDs. Do not try to play any other type of discs.

#### To play a CD:

- 1 Connect the headphones (included) or optional earphones into the **PHONE** jack on your CD player.
- 2 Press the **OPEN** button to open the CD compartment door, insert a disc with the label side facing up, then press down on the CD compartment door until you hear a click.
- 3 Set the **VOLUME** control to minimum.
- 4 Press the **▶|| / ▲ / POWER ON** button. Your CD player turns on and starts playing the disc. **Now Reading** and the elapsed time appear on the display.
- 5 Adjust the volume to a comfortable level. Do not play a disc at a loud volume level because you may damage your hearing.
- 6 To pause playback, press the **▶|| / ▲ / POWER ON** button. The elapsed time and track number flash on the display. Press the button again to resume playback.
- 7 To stop playback, press the **■ / ▼ / POWER OFF** button once. The total number of audio CD tracks (or the total number of folders and the total number of MP3 tracks) appears on the display.
- 8 To turn off your CD player, press and hold the **■ / ▼ / POWER OFF** button.

#### Notes

If the CD compartment door opens accidentally during playback, **OPEN** appears on the display. Make sure that the CD has stopped spinning before you open the CD compartment door. If you open the door, playback stops.

Your CD player can play 3-inch (8 cm) single CDs without an adapter.

If you try to play a CD-RW that has not been recorded correctly, **Disc Error** appears on the display.



When a disc is playing, press **MENU/PRESET/ESP** to turn on the ESP feature. **ESP** flashes on the display.



### Automatic power off

If your CD player has been in stop (standby) mode for 60 seconds, or paused for five minutes, it turns off automatically to save battery power. When your CD player turns off, all settings, such as program and playing modes, are erased.

### Searching for a track

Button	Description
	Press once to go to the beginning of the currently playing track. Press repeatedly to go to backwards through the tracks. Press and hold to search backwards at high speed.
	Press once to go to the next track. Press repeatedly to go forward through the tracks. Press and hold to search forward at high speed.

#### Note

Low level audio is played when you search on an audio CD to help you locate the track or section you want.

### Searching for a track name on an MP3 CD

#### To search for a track name on an MP3 CD:

- 1 When playing an MP3 CD, press the **MENU/ESP/PRESET** button once. **ABCDEFGHIJKL** appears on the display. Press the **▶|| / ▲ / POWER ON** button. **MNOPQRSTUVWXYZ** appears on the screen. Press the **▶|| / ▲ / POWER ON** button again. **YZ0123456789** appears on the screen.
- 2 Press the **◀◀ / ◀** or **▶▶ / ▶** button to select a letter. The letter flashes on the display.

#### Tip

If an MP3 file name has symbols (for example, \*, /, -, !, or =), select the symbol on the display.

- 3 Press the **MEMORY/ENTER** button. If your CD player finds more than one track that starts with the letter you selected, the first track name flashes on the display. Press the **◀◀ / ◀** or **▶▶ / ▶** button to select a track, then press the **MEMORY/ENTER** button. Playback begins after you select a track.

# INSIGNIA™

Insignia NS-P5113 Portable CD Player with FM

## Using repeat playback

### To repeat a track, an entire CD, or an MP3 album (folder):

- 1 Press the **▶||| / ▲ / POWER ON** button.
- 2 To repeat the same track, press the **PLAY MODE** button once. **REP 1** appears on the display. Your CD player repeats the current track until you press the **■ / ▼ / POWER OFF** button or press the **PLAY MODE** button four times for an audio CD and 5 times for an MP3 CD.
- 3 To repeat the entire CD, press the **PLAY MODE** button twice. **REP A** appears on the display. Press the **PLAY MODE** button three times for an audio CD or four for an MP3 CD to cancel repeat mode.
- 4 To repeat an MP3 album (folder), press the **PLAY MODE** button three times. **REP D** appears on the display. Press the **PLAY MODE** button three times to cancel repeat mode.

## Using INTRO play

You can play the first 10 seconds of each track on a CD to help you find the track you want.

### To use INTRO play:

- 1 Press the **▶||| / ▲ / POWER ON** button.
- 2 Press the **PLAY MODE** button three times for an audio CD or four times for an MP3 CD to start INTRO play. **INTRO** appears on the display. Your CD player plays the first 10 seconds of each track.

#### Tip

After your CD player plays the first 10 seconds of all the tracks on the CD, your player waits 60 seconds, then turns off.

- 3 Press the **PLAY MODE** button twice more to cancel INTRO play and resume normal playback.

## Playing tracks randomly

### To randomly play tracks:

- 1 Press the **PLAY MODE** button four times for an audio CD or five times for an MP3 CD to start random mode. **RANDOM** appears on the display.
- 2 Press the **▶||| / ▲ / POWER ON** button to start playback in random order.
- 3 Press the **◀◀ / ◀** or **▶▶ / ▶** button to go to the previous or next random track.
- 4 Press the **PLAY MODE** button to return to the normal playback.

## Using the anti-shock feature

When your CD player moves during playback (for example, when you are walking or in a moving vehicle), your player may be subject to bumps or vibrations.

When you press the **▶|| / ▲ / POWER ON** and **MENU/PRESET/ESP** buttons, the anti-shock feature turns on and **ESP** flashes on the display. The CD spins faster and your CD player stores the audio in memory to make sure that playback does not pause or skip.

If the memory buffer gets full, ESP stops flashing on the display. If your player is bumped or vibrated too much or the memory buffer is empty, the sound mutes for a short time. After the bumping or vibration stops, your player resumes normal playback.

### Notes

You should use the anti-shock feature only when necessary. Using the anti-shock feature while your CD player is running on battery power uses additional battery power.

To turn off the anti-shock feature when playing an audio CD, press the **MENU/ESP/PRESET** button. You cannot turn off the anti-shock feature when playing an MP3 CD.

The anti-shock feature will not correct playback errors if the CD is scratched or dirty. The ESP default is off.

## Playing the radio

### Note

The headphone cable is the FM antenna. For best reception, make sure that the cable is fully extended.

### To play the radio:

- 1 Set the **FUNCTION** switch to **RADIO**, then press the **▶|| / ▲ / POWER ON** button.
- 2 Press the **PLAY MODE** button to select **FM MONO** or **FM STEREO**.

### Note

If you select **FM STEREO** and the radio signal is weak, **STEREO** appears on the display. Press the **PLAY MODE** button to switch to **FM MONO**. The audio plays in mono, but the background static is reduced.

- 3 To turn off the radio, press and hold the **■ / ▼ / POWER OFF** button.

# INSIGNIA™

Insignia NS-P5113 Portable CD Player with FM

## Tuning to a radio station

### To manually tune to a radio station:

- Quickly press and release the **◀◀/◀** or **▶▶/▶** button one or more times until you find the station you want.

### To automatically tune to a radio station:

- Press and hold the **◀◀/◀** or **▶▶/▶** button. Your CD player automatically tunes to the first clear station.

## Programming radio stations

You can program as many as 10 radio stations into memory.

### To program a station:

- 1 Set the **FUNCTION** switch to **RADIO**.
- 2 Tune to the station you want to program.
- 3 Press the **MEMORY/ENTER** button. **MEMORY:01** appears on the display.
- 4 Press the **MENU/ESP/PRESET** button to select the storage location, then press **MEMORY/ENTER** button to save. Repeat steps 3 and 4 to program additional stations.

#### Note

If you program a station to a preset number that already has been assigned to a station, the new station replaces the old station.

## Tuning to a programmed station

### To tune to a programmed station:

- 1 Set the **FUNCTION** switch to **RADIO**.
- 2 Press the **▶▶/▶** / **▲** / **POWER ON** button to turn on the radio.
- 3 Press the **MENU/ESP/PRESET** button one or more times until the preset number you want appears on the display.

## Troubleshooting

### Warning

Do not try to repair your CD player. There are no serviceable parts inside. Opening the case voids your warranty. Refer all servicing to qualified service personnel.

Problem	Possible cause	Possible solution
CD player will not turn on.	Batteries are inserted incorrectly.	Make sure that the + and – symbols on the batteries match the + and – symbols inside the battery compartment.
	Batteries are dead.	Replace the batteries.
	AC power adapter is not connected correctly.	Make sure that the AC power adapter is connected correctly.
CD does not play or stops playing	CD compartment door is not closed.	Press down on the CD compartment door to make sure that it is completely closed.
	Water may have condensed on the lens.	Open the CD compartment door and leave it open for about one hour to let it dry out.
	CD is inserted incorrectly.	Make sure that the CD is inserted with the label facing up.
	CD is scratched or damaged.	Try another CD.
	MP3 files may have been corrupted when they were created or downloaded, or when they were being recorded to the CD.	Make sure that the MP3 files are not corrupt. If necessary, burn the files to a new CD.
No sound or poor sound quality.	Cables may not be connected correctly and securely.	Make sure that all the cables are connected correctly and securely.
	Volume is set too low.	Increase the volume.
	The headphone connector may be dirty.	Clean the headphone connector.
	Your CD player may be too close to magnetic interference, such as unshielded speakers.	Move your CD player away from magnetic fields.
	Temperature inside the car may be too cold or too hot.	Adjust the car temperature.
	The cigarette socket may be dirty.	Clean the cigarette socket.
	Your CD player may be in reverse mode.	Make sure that your CD player is not in reverse mode.

### Note

If the CD is still not playing correctly after you try these troubleshooting solutions, turn off your CD player, wait five seconds, then turn it on again.

# INSIGNIA™

---

Insignia NS-P5113 Portable CD Player with FM

## Maintaining

### Handling CDs

- To remove a CD from its case, hold it at the edges while you press down gently on the center hole.
- Do not touch the shiny surface of the CD or bend the CD.
- Place the CD into the CD compartment with the label facing up.
- Store CDs in their cases when you are not using them.
- Do not store CDs in areas where they can get hot, such as an automobile.
- Do not write on the label side of the CD with a ballpoint pen because you may scratch the surface.

### Cleaning CDs

A dirty CD may not play correctly.

#### To clean a CD:

- With a soft cloth, wipe the CD in a straight line from the center to the edge.

#### Caution

Do not use any solvent, such as record spray, thinner, or benzene, to clean a CD.

### Cleaning your CD player

#### To clean your CD player, follow these guidelines:

- Use a soft, clean cloth moistened with plain, luke-warm water to clean the exterior of your CD player.
- Never use solvents such as benzene or other strong chemical cleaners because these could damage your CD player's finish.
- Do not let liquid drip into the inside of your CD player.

Insignia NS-P5113 Portable CD Player with FM

INSIGNIA™

## Specifications

### Radio

Frequency	87.5MHz-107.9MHz
Step	200 KHz

### Audio

D/A conversion	1-bit DAC, 8 times oversampling
Frequency response	20-20,000 Hz
Anti-shock	CD: 45 seconds MP3: 120 seconds
Wow and flutter	Below measurable limits
Number of channels	2 channels (stereo)
Output level	Line output: 0.6V rms (47K Ohm) Headphone: 15mW (32 Ohm)

### MP3

#### Note

Make sure that your CD burner (recorder) complies with these specifications. For more information, see the CD burner documentation.

MPEG rate	32-384 Kbps
Sampling frequency	8/48 KHz
MP3 playback	ISO9660-format compatible
MPEG rate supported	MP3 format: Supported 32~384kbps and VBR compatible

### Power

General power requirements	2 LR6 / UM-3 / AA alkaline batteries DC IN 4.5 V jack accepts AC power adapter (center positive)
Power consumption	0.8 W (DC 3V)

#### Note

Specifications and design are subject to change without notice.

**INSIGNIA™**

Insignia NS-P5113 Portable CD Player with FM

## Legal notices

### FCC Part 15

**Warning**

Modifications not authorized by the manufacturer may void the user's authority to operate this device.

This device complies with Part 15 of the FCC Rules. Operation of this product is subject to the following two conditions: (1) this device may not cause harmful interference, and (2) this device must accept any interference received, including interference that may cause undesired operation.

This equipment has been tested and found to comply within the limits for a class B digital device, pursuant to Part 15 of the FCC Rules. These limits are designed to provide reasonable protection against harmful interference in a residential installation. This equipment generates, uses, and can radiate radio frequency energy and, if not installed and used in accordance with the instructions, may cause harmful interference to radio communications. However, there is no guarantee that interference will not occur in a particular installation. If this equipment does cause harmful interference to radio or television reception, which can be determined by turning the equipment off and on, the user is encouraged to try to correct the interference by one or more of the following measures:

- Reorient or relocate the receiving antenna.
- Increase the separation between the equipment and receiver.
- Connect the equipment into an outlet on a circuit different from that to which the receiver is connected.
- Consult the dealer or an experienced technician for help.

### Canada ICES-003 statement

This Class B digital apparatus complies with Canadian ICES-003.

### Copyright

INSIGNIA is a trademark of Best Buy and its affiliated companies.  
Registered in some countries. Distributed by Best Buy Purchasing, LLC  
7601 Penn Ave South, Richfield, MN 55423 U.S.A.  
©2014 Best Buy. All rights reserved.  
Made in China



Insignia NS-P5113 Portable CD Player with FM

INSIGNIA™

## ONE-YEAR LIMITED WARRANTY - INSIGNIA

### Definitions:

The Distributor\* of Insignia branded products warrants to you, the original purchaser of this new Insignia-branded product ("Product"), that the Product shall be free of defects in the original manufacturer of the material or workmanship for a period of one (1) year from the date of your purchase of the Product ("Warranty Period").

For this warranty to apply, your Product must be purchased in the United States or Canada from a Best Buy branded or Future Shop branded retail store or online at [www.bestbuy.com](http://www.bestbuy.com), [www.bestbuy.ca](http://www.bestbuy.ca), or [www.futureshop.ca](http://www.futureshop.ca) and is packaged with this warranty statement.

### How long does the coverage last?

The Warranty Period lasts for 1 year (365 days) from the date you purchased the Product. Your purchase date is printed on the receipt you received with the Product.

### What does this warranty cover?

During the Warranty Period, if the original manufacture of the material or workmanship of the Product is determined to be defective by an authorized Insignia repair center or store personnel, Insignia will (at its sole option): (1) repair the Product with new or rebuilt parts; or (2) replace the Product at no charge with new or rebuilt comparable products or parts. Products and parts replaced under this warranty become the property of Insignia and are not returned to you. If service of Products or parts are required after the Warranty Period expires, you must pay all labor and parts charges. This warranty lasts as long as you own your Insignia Product during the Warranty Period. Warranty coverage terminates if you sell or otherwise transfer the Product.

### How to obtain warranty service?

If you purchased the Product at a Best Buy or Future Shop retail store location, please take your original receipt and the Product to any Best Buy or Future Shop store. Make sure that you place the Product in its original packaging or packaging that provides the same amount of protection as the original packaging. If you purchased the Product from a Best Buy or Future Shop online web site ([www.bestbuy.com](http://www.bestbuy.com), [www.bestbuy.ca](http://www.bestbuy.ca), or [www.futureshop.ca](http://www.futureshop.ca)), mail your original receipt and the Product to the address listed on the web site. Make sure that you put the Product in its original packaging or packaging that provides the same amount of protection as the original packaging.

To obtain warranty service, in the United States call 1-888-BESTBUY, Canada call 1-866-BESTBUY for Future Shop call 1-800-663-2275. Call agents may diagnose and correct the issue over the phone.

### Where is the warranty valid?

This warranty is valid only in the United States and Canada at Best Buy or Future Shop branded retail stores or websites to the original purchaser of the product in the county where the original purchase was made.

### What does the warranty not cover?

This warranty does not cover:

- Customer instruction/education
- Installation

INSIGNIA™

Insignia NS-P5113 Portable CD Player with FM

- Set up adjustments
- Cosmetic damage
- Damage due to weather, lightning, and other acts of God, such as power surges
- Accidental damage
- Misuse
- Abuse
- Negligence
- Commercial purposes/use, including but not limited to use in a place of business or in communal areas of a multiple dwelling condominium or apartment complex, or otherwise used in a place of other than a private home.
- Modification of any part of the Product, including the antenna
- Display panel damaged by static (non-moving) images applied for lengthy periods (burn-in).
- Damage due to incorrect operation or maintenance
- Connection to an incorrect voltage or power supply
- Attempted repair by any person not authorized by Insignia to service the Product
- Products sold "as is" or "with all faults"
- Consumables, including but not limited to batteries (i.e. AA, AAA, C etc.)
- Products where the factory applied serial number has been altered or removed
- Loss or Theft of this product or any part of the product
- Display panels containing up to three (3) pixel failures (dots that are dark or incorrectly illuminated) grouped in an area smaller than one tenth (1/10) of the display size or up to five (5) pixel failures throughout the display. (Pixel based displays may contain a limited number of pixels that may not function normally.)
- Failures or Damage caused by any contact including but not limited to liquids, gels or pastes.

REPAIR REPLACEMENT AS PROVIDED UNDER THIS WARRANTY IS YOUR EXCLUSIVE REMEDY FOR BREACH OF WARRANTY. INSIGNIA SHALL NOT BE LIABLE FOR ANY INCIDENTAL OR CONSEQUENTIAL DAMAGES FOR THE BREACH OF ANY EXPRESS OR IMPLIED WARRANTY ON THIS PRODUCT, INCLUDING, BUT NOT LIMITED TO, LOST DATA, LOSS OF USE OF YOUR PRODUCT, LOST BUSINESS OR LOST PROFITS. INSIGNIA PRODUCTS MAKES NO OTHER EXPRESS WARRANTIES WITH RESPECT TO THE PRODUCT, ALL EXPRESS AND IMPLIED WARRANTIES FOR THE PRODUCT, INCLUDING, BUT NOT LIMITED TO, ANY IMPLIED WARRANTIES OF AND CONDITIONS OF MERCHANTABILITY AND FITNESS FOR A PARTICULAR PURPOSE, ARE LIMITED IN DURATION TO THE WARRANTY PERIOD SET FORTH ABOVE AND NO WARRANTIES, WHETHER EXPRESS OR IMPLIED, WILL APPLY AFTER THE WARRANTY PERIOD. SOME STATES, PROVINCES AND JURISDICTIONS DO NOT ALLOW LIMITATIONS ON HOW LONG AN IMPLIED WARRANTY LASTS, SO THE ABOVE LIMITATION MAY NOT APPLY TO YOU. THIS WARRANTY GIVES YOU SPECIFIC LEGAL RIGHTS, AND YOU MAY ALSO HAVE OTHER RIGHTS, WHICH VARY FROM STATE TO STATE OR PROVINCE TO PROVINCE.

Contact Insignia:

For customer service please call 1-877-467-4289

[www.insigniaproducts.com](http://www.insigniaproducts.com)

INSIGNIA is a trademark of Best Buy and its affiliated companies.

Registered in some countries.

Distributed by Best Buy Purchasing, LLC

7601 Penn Ave South, Richfield, MN 55423 U.S.A.

©2014 Best Buy. All rights reserved.

Made in China

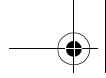

Insignia NS-P5113 Portable CD Player with FM

INSIGNIA™

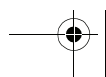
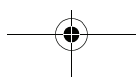
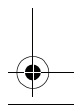
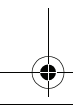
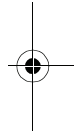
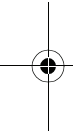

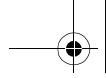

# INSIGNIA™

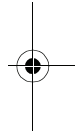
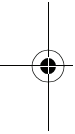

[www.insigniaproducts.com](http://www.insigniaproducts.com)  
1-877-467-4289 (U.S. and Canada) or 01-800-926-3000 (Mexico)

INSIGNIA is a trademark of Best Buy and its affiliated companies.  
Registered in some countries.  
Distributed by Best Buy Purchasing, LLC  
7601 Penn Ave South, Richfield, MN 55423 U.S.A.  
©2014 Best Buy. All rights reserved.  
Made in China.

V3 ENGLISH  
14-0988

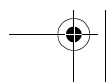
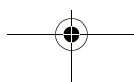
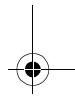
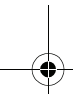

## Free Manuals Download Website

<http://myh66.com>

<http://usermanuals.us>

<http://www.somanuals.com>

<http://www.4manuals.cc>

<http://www.manual-lib.com>

<http://www.404manual.com>

<http://www.luxmanual.com>

<http://aubethermostatmanual.com>

Golf course search by state

<http://golfingnear.com>

Email search by domain

<http://emailbydomain.com>

Auto manuals search

<http://auto.somanuals.com>

TV manuals search

<http://tv.somanuals.com>