

V3
FINAL
FOR PRINT

NS-BIPCD02_14-0811_MAN_V3_ENG.fm Page 1 Tuesday, August 5, 2014 7:22 AM

USER GUIDE

INSIGNIA™

CD Boombox with Dock for iPhone 4/4s

NS-BIPCD02



Before using your new product, please read these instructions to prevent any damage.

INSIGNIA™ NS-BIPCD02 CD Boombox with Dock for iPhone 4/4s

NS-BIPCD02

CD Boombox with Dock for iPhone 4/4s

Contents

Introduction	2
Safety information	2
Features	4
Setting up your boombox	8
Using your boombox	9
Troubleshooting	15
Specifications	16
Legal notices	17
ONE-YEAR LIMITED WARRANTY - INSIGNIA	18

Introduction

Congratulations on your purchase of a high-quality Insignia product. Your NS-BIPCD02 represents the state of the art in boomboxes and is designed for reliable and trouble-free performance.

Safety information



This symbol indicates that dangerous voltage constituting a risk of electric shock is present within your boombox. This label is located on the back of your boombox.



This symbol indicates that there are important operating and maintenance instructions in the literature accompanying your boombox.

Important safety instructions

- 1 Read these instructions.
- 2 Keep these instructions.
- 3 Heed all warnings.
- 4 Follow all instructions.
- 5 Do not use this apparatus near water.
- 6 Clean only with a dry cloth.
- 7 Do not block any ventilation openings. Install in accordance with the manufacturer's instructions.
- 8 Do not install near any heat sources such as radiators, heat registers, stoves, or other apparatus (including amplifiers) that produce heat.
- 9 Do not defeat the safety purpose of the polarized or grounding-type plug. A polarized plug has two blades with one wider than the other. A grounding type plug has two blades and a third grounding prong. The wide blade or the third prong are provided for your safety. If the provided plug does not fit into your outlet, consult an electrician for replacement of the obsolete outlet.
- 10 Protect the power cord from being walked on or pinched particularly at plugs, convenience receptacles, and the point where they exit from the apparatus.
- 11 Only use attachments/accessories specified by the manufacturer.
- 12 Unplug this apparatus during lightning storms or when unused for long periods of time.
- 13 Refer all servicing to qualified service personnel. Servicing is required when the apparatus has been damaged in any way, such as power-supply cord or plug is damaged, liquid has been spilled or objects have fallen into the apparatus, the apparatus has been exposed to rain or moisture, does not operate normally, or has been dropped.
- 14 To reduce the risk of fire or electric shock, do not expose this device to rain, moisture, dripping, or splashing, and no objects filled with liquids, such as vases, shall be placed on it.
- 15 An apparatus with a three-prong, grounding-type plug is a Class I apparatus, which needs to be grounded to prevent possible electric shock. Make sure that you connect this Class I device to a grounding-type, three-prong outlet.
- 16 The wall plug is the disconnecting device. The plug must remain readily operable.

INSIGNIA™

NS-BIPCD02 CD Boombox with Dock for iPhone 4/4s

17 Batteries should not be exposed to excessive heat such as sunshine, fire, or the like.

Warning

Danger of explosion if battery is incorrectly replaced. Replace only with the same or equivalent type.

Class II equipment symbol
This symbol indicates that the unit has a double insulation system .



Features

Package contents

- Boombox
- AC Power Adapter
- *Quick Setup Guide*
- *User Guide*

Top view

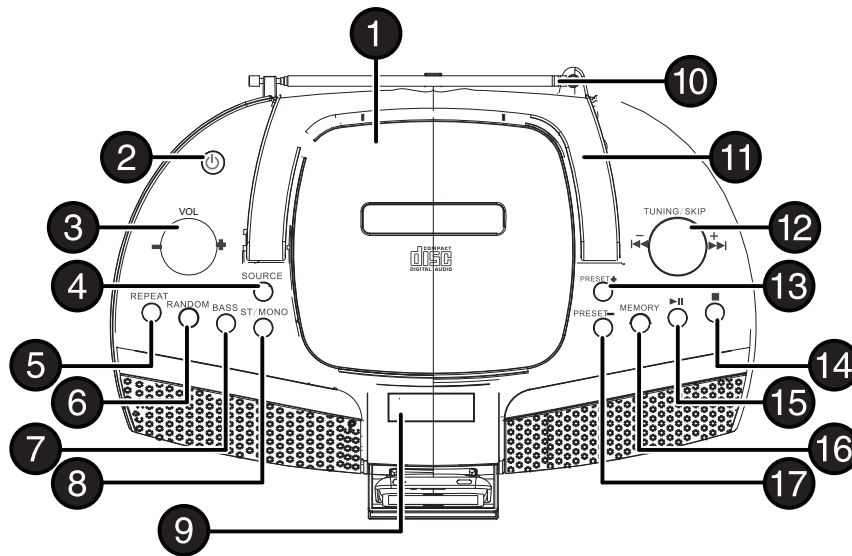

#	Item	Description
1	CD door	Open to insert or remove a CD.
2	⏻ (power) button	Press to turn on your boombox or put it into standby mode.
3	VOL +/-	Push the left side to lower the volume, or the right side to raise the volume.
4	SOURCE button	Press repeatedly to select the mode you want. Options include TUNER , iPod , CD , and AUX .
5	REPEAT button	Press once to repeat the current CD selection. Press twice to repeat the entire CD. Press a third time to cancel repeat mode.
6	MUTE button	Press to mute the sound. Press again to resume normal listening.
7	BASS button	Press to activate the enhanced bass response of your boombox.
8	ST/MONO button	Press to toggle between stereo and mono FM radio reception.
9	LCD display	Displays mode, frequency, and playback information.
10	FM antenna	Extend the FM antenna to improve the FM radio reception.
11	Carrying handle	Use to carry your boombox from one location to another.

INSIGNIA™

NS-BIPCD02 CD Boombox with Dock for iPhone 4/4s

#	Item	Description
12	TUNING/SKIP ◀◀/▶▶ buttons	In tuner mode: <ul style="list-style-type: none"> • Press to go to a lower or higher radio frequency. • Press for more than one second to auto scan for the next lower or higher radio station. In CD playback mode: <ul style="list-style-type: none"> • Press ◀◀ once to skip to the beginning of the current selection. • Press ▶▶ once to skip to the next selection. • Press ◀◀ twice to skip to the beginning of the previous selection or press ▶▶ twice to skip to the beginning of the next selection. • Press ◀◀ and hold to search backward for a specific track. • Press ▶▶ and hold to search forward for a specific track.
13	PRESET+ button	Press to tune the FM radio to the next preset station.
14	■ (stop) button	Press to stop playback.
15	▶▶ (play/pause) button	Press to start CD playback. Press again to pause playback. Press again to resume playback.
16	MEMORY button	Press to save preset FM radio stations. After pressing the MEMORY button, press PRESET+ or PRESET- to set the preset number. You can save up to 30 presets.
17	PRESET- button	Press to tune the FM radio to the previous preset station.

Front

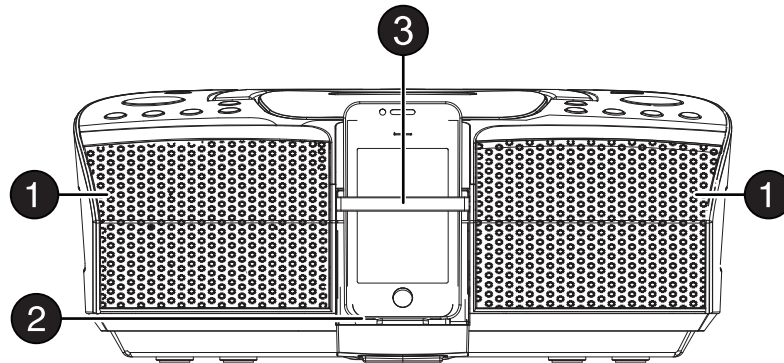

#	Item	Description
1	Speakers	Provides sound from your boombox.
2	iPod/iPhone dock	Connect your iPod/iPhone to this dock to play selections through your boombox.
3	iPhone holder	Protects your iPhone when it's docked.

Back

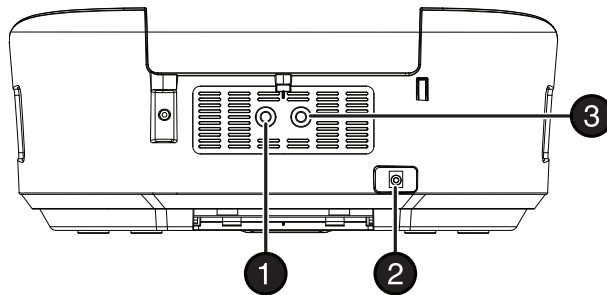

#	Item	Description
1	Headphone jack	Connect a pair of headphones to this connector with a 3.5 mm plug.
2	DC IN jack	Connect the AC Adapter to this jack.
3	AUX IN jack	Connect an external sound source, such as an MP3 player, to this connector.

Bottom

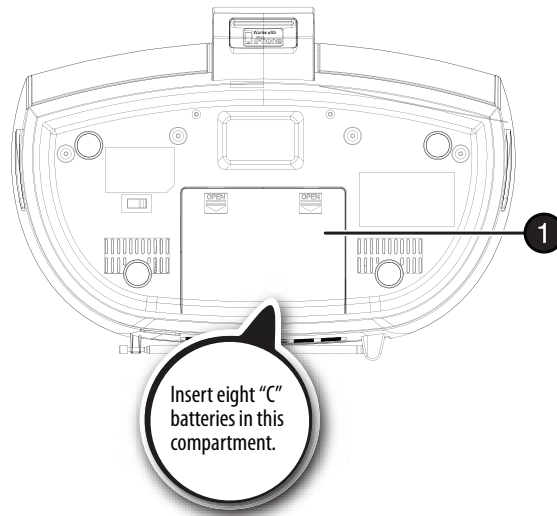

#	Item	Description
1	Battery compartment door	Insert eight "C" size batteries into this compartment, observing the correct polarity indicated.

INSIGNIA™

NS-BIPCD02 CD Boombox with Dock for iPhone 4/4s

Setting up your boombox

Powering your boombox

Your boombox can be powered by either the included AC Adapter, or by using eight "C" sized alkaline batteries. Your boombox only operates on batteries if the AC adapter is unplugged.

Installing the batteries

To install the batteries:

- 1 Open the battery compartment on the bottom of your boombox.
- 2 Place eight "C" size alkaline batteries (not included) into the battery compartment. Make sure to match the + and - on the battery to the + and - signs in the battery compartment.
- 3 Close the battery compartment until it clicks into place.

Caution

- When you replace the batteries, make sure that you use batteries of the same type and voltage. The batteries are "C" size alkaline.
- All batteries should be replaced at the same time.
- Dispose of used batteries by following your local hazardous waste regulations.
- If you don't plan to use your boombox for an extended period of time, remove the batteries to prevent damage.

Note

BATT LOW will be shown on the display when the batteries are lower than 20% capacity.

Connecting the AC adapter

To connect the AC adapter:

- 1 Plug the small connector at the end of the power cord into the DC IN jack on the back of your boombox.
- 2 Plug the AC adapter into a 120/240V, 50/60Hz power outlet.

Using your boombox

Turning on your boombox

To turn on your boombox:

- Press  (power) on the top of your boombox.

Selecting the mode (source)

To select the mode (sound source):

- Press **SOURCE** repeatedly on the top of your boombox to select **FM**, **CD**, **iPod/iPhone**, or **AUX**. The source you select appears on the display.

Volume control

After you select the mode you want, press **VOLUME+** or **-** to set the volume to a comfortable level.

Using the iPod/iPhone dock

When an iPod/iPhone is inserted into the dock, the device will automatically play the iPod and your iPod/iPhone will begin charging.

Note

The volume control on the iPod/iPhone only adjusts the volume of the headphones connected to it. To adjust the volume when connected to the boombox, use the volume control on top of the boombox.

To use the iPod/iPhone dock:

- 1 Insert your iPod or iPhone into the iPod/iPhone dock on the front of your boombox.
- 2 Press  (power) on the top of your boombox to turn it on.
- 3 Repeatedly press the **SOURCE** button to select iPod mode. iPod appears on the display.



INSIGNIA™

NS-BIPCD02 CD Boombox with Dock for iPhone 4/4s

If there are any available music tracks on your iPod/iPhone, they will start playing back from the point playback was last stopped or paused. If there are no files of the proper format on your iPod/iPhone, "iPod" blinks on the display.



4 Control iPod/iPhone playback as follows:

- Press **▶||** (play/pause) to start playback. Press **▶||** (play/pause) again to pause or stop playback. Press it again to resume playback.

Note

If your iPhone receives a call during playback, the playback stops so your ringtone can be heard.

- To skip to the next or a previous track during playback, press **▶▶** or **◀◀** on the top of your boombox repeatedly until the desired track is found. The selected track plays from the beginning.
- Press **◀◀** on the top of your boombox during playback to play the current track from the beginning. To return to the beginning of the previous track, press **◀◀** twice.
- To search for a part of a track during playback, press and hold **▶▶** or **◀◀** on the top of your boombox for more than two seconds and release it when the point in the track you want to listen to is found.
- To turn on Repeat mode during playback, press **REPEAT** repeatedly to cycle through the repeat options as follows:

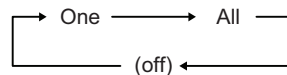

Note

If the iPod/iPhone is set to repeat one song, the Repeat One icon (↺) appears in the iPod/iPhone's display. If the iPod/iPhone is set to repeat all songs, the Repeat icon (↻) appears in the iPod/iPhone's display.

Receiving phone calls

To receive a phone call on your iPhone:

- If your iPhone is setup without a ring tone, your boombox is muted until the call is completed, at which time it resumes playing music.
- If your iPhone is setup with a ring tone, your boombox plays the ring tone but the call is heard through your iPhone. After the call, your boombox stays in iPod mode and resumes playing music.
- Your iPhone can stay connected to the dock and automatically switches to speakerphone mode.

Using the CD player

To use the CD player:

- 1 Press **SOURCE** repeatedly on the top of your boombox to select **CD**. "NO DISC" appears on the display.

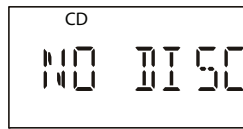

- 2 Lift the CD door and place a CD on the spindle until it clicks, label side up, then close the CD door. The CD player starts reading the disc.
- 3 Press **▶||** (play/pause) to begin playback. The display shows the current track and elapsed play time.

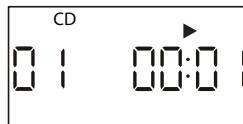

Note

If the door is opened during playback, playback stops immediately and any repeat mode setting is reset.

- 4 Control CD playback as follows:
 - Press **▶||** (play/pause) to pause playback. Press again to resume playback.
 - Press **■** (stop) to stop playback.
 - Press **▶▶** once to skip to the next track. If the CD is playing, your boombox skips to the next track and starts playing. If the CD is stopped, your boombox skips to the beginning of the next track.

INSIGNIA™

NS-BIPCD02 CD Boombox with Dock for iPhone 4/4s

- Press **⏮** once to skip to the beginning of the current track. If the CD is playing, it begins playing the track again. If the CD is stopped, your boombox skips to the beginning of the current track.
- Press **⏮** twice to skip to the beginning of the previous track. If the CD is playing, it begins playing the track.
- Press **⏭** and hold to fast forward. Release to stop the search.
- Press **⏪** and hold to fast reverse. Release to stop the search.
- Press **REPEAT** once to repeat the current track. "REP" appears on the display.

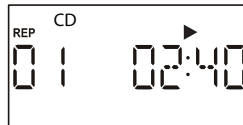

- Press **REPEAT** twice to repeat the entire CD. "REP ALL" appears on the display.

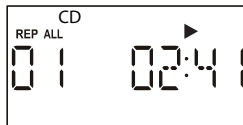

To return to normal playback, press **REPEAT** until the "REP" icon disappears from the display. Press **■** (stop) to stop playback during Repeat mode. Press **■** (stop) again to cancel Repeat mode.

Playing music from an external sound source

To play music from an external sound source:

- 1 Connect an external sound source, such as an MP3 player, by plugging an audio cable with a 3.5 mm plug (not included) into the **AUX IN** jack on the back of your boombox.
- 2 Press **SOURCE** repeatedly on the top of your boombox to select **AUX**. "AUX" appears on the display.

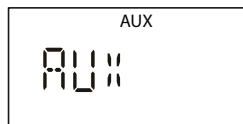

- 3 Start playback on the external device.
- 4 Press **VOLUME+** or **-** to adjust the volume.
- 5 Control playback using the controls on the external device.

Using FM mode

FM mode is the default mode on your boombox and is selected when you turn your boombox on.

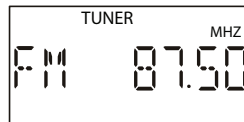

Tuning to a station

To tune to a station:

- 1 Press **◀◀** or **▶▶** on the top of your boombox to tune the FM radio to the previous or next frequency. Press and hold the buttons to tune quickly to the approximate frequency, then tap the buttons repeatedly until the display indicates the frequency you want.
- 2 Press and hold **◀◀** or **▶▶** on the top of your boombox momentarily. The tuner moves up or down by 0.2 MHz.
- 3 Press **PRESET+/-** on the top of your boombox to go to the next higher or lower preset station. See "Storing preset stations in memory" on page 13 for information on setting preset stations.

Storing preset stations in memory

Your boombox can store 30 FM stations in memory. When you store a station in memory, you can tune to the stored (preset) station by repeatedly pressing **PRESET+** or **PRESET-** on the top of your boombox.

To store stations in memory:

- 1 Press **SOURCE** repeatedly on the top of your boombox to select **FM** mode.
- 2 Press **◀◀** or **▶▶** on the top of your boombox to tune to the station you want to store.

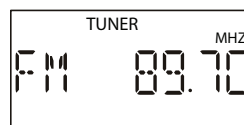

INSIGNIA™

NS-BIPCD02 CD Boombox with Dock for iPhone 4/4s

- 3 Press **MEMORY** once to store the station ("MEMORY" flashes on the display).

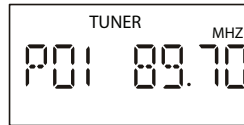

- 4 Press **PRESET+/-** repeatedly until the display shows the preset number you want to save.

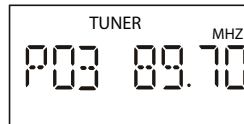

- 5 Press **MEMORY** again to complete the operation. The station is stored in memory (in this example, as preset #3.)

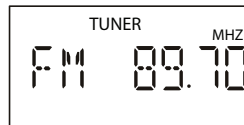

Tuning to a preset station

To tune to a preset station:

- Press **PRESET+/-** on the top of your boombox to go to the next higher or lower preset station.

Selecting stereo or mono broadcasts

To select stereo or mono broadcasts:

- In FM mode, press the **ST/MONO** button to toggle between stereo and mono modes.

FM stereo broadcasts are typically received in stereo (the "ST" indicator lights in the display). However, if the sound is distorted and the "ST" indicator does not light, the signal is not strong enough for good stereo reception. In that case, change to MONO mode.

Mono

To compensate for weak FM stereo reception, select this mode. Reception is forced to monaural, reducing unwanted noise.

Using headphones

Use headphones with a 16-32 Ohm impedance and a 3.5mm connector in the Headphone jack. Use corresponding adaptors (available at your local electronics store) if you have a different connector. The speakers are automatically switched off when the headphones are being used.

Caution

Listening to music at high volume for long periods of time can damage your ears.

Troubleshooting

Problem	Solution
My boombox won't turn on.	<ul style="list-style-type: none"> Make sure that the power cord is fully inserted in the power outlet and firmly connected to the DC IN jack on the back. If running on batteries, make sure the batteries are not dead.
No sound.	<ul style="list-style-type: none"> Make sure that power is connected and your boombox is turned on. Make sure your external device is turned on and is playing. Make sure the volume on your external device is turned up and is not set to mute. Make sure that the volume is not extremely low.
My boombox will not play in FM mode.	<ul style="list-style-type: none"> Repeatedly press the SOURCE button to select FM mode. Make sure that the radio is correctly tuned to an FM station. Make sure that the FM antenna is extended.
My boombox will not play in CD mode.	<ul style="list-style-type: none"> Repeatedly press the SOURCE button to select CD mode. Make sure that the CD is correctly inserted with the label facing up. Make sure that the CD is not a DVD.
The CD skips while playing.	<ul style="list-style-type: none"> Make sure that the CD is not dirty or scratched. Clean the CD. Make sure you are using a standard CD (normal size and shape).
My iPod/iPhone won't play.	<ul style="list-style-type: none"> Make sure your iPod/iPhone is on and charged. Repeatedly press the SOURCE button to select iPod mode. Make sure your iPod is not paused. Make sure that your iPod is properly docked. Make sure that there are songs in your iPod. Make sure that the hold function is not activated on your iPod. Make sure that your iPod is working properly before you dock it into your boombox. Remove your iPod from the docking compartment. Clean the connectors in the docking compartment and on your iPod, then replace it in the docking compartment. Your iPod software may be outdated. Upgrade its software. For details, visit www.apple.com.

INSIGNIA™ NS-BIPCD02 CD Boombox with Dock for iPhone 4/4s

Problem	Solution
My external audio device (MP3 player) won't play.	<ul style="list-style-type: none"> • Make sure your external device is on and charged. • Repeatedly press the SOURCE button to select AUX mode. • Make sure your external device is not paused. • Make sure the audio cable is fully inserted into the external device and the AUX IN jack on the boombox. • Make sure that there are songs in your external device. • Make sure that your external device is working properly before you connected it to your boombox.
My iPod won't charge when it's docked.	<ul style="list-style-type: none"> • Make sure that your iPod is properly docked and your boombox is set to iPod mode. • Make sure that the hold function is not activated on your iPod. • Make sure that your iPod battery is not faulty. • Make sure that the power cord is plugged in. An iPod will not charge from battery power.

Maintaining

- To prevent fire or shock hazard, disconnect your boombox from the AC power source when cleaning.
- The finish on your boombox may be cleaned with a dust cloth and cared for as other furniture, Use caution when cleaning and wiping the plastic parts.
- If the front panel becomes dirty or smudged with fingerprints it may be cleaned with a soft cloth slightly dampened with a mild soap and water solution. Never use abrasive cloths or polishes as these will damage the finish of your boombox.

Caution

- Never allow water or other liquids to get inside your boombox.
- Modifying or tampering with the internal components of your boombox can cause a malfunction and might invalidate its warranty. If your boombox is not performing as it should, take it to the local dealer for assistance.

Specifications

General	
Power requirement	DC 12V or eight "C" size alkaline batteries
Dimensions (WxHxD)	14.69 x 6.10 x 9.29 in. (373 x 155 x 236 mm)
Weight	3.31 lbs. (1.5 kg)

Receiver section	
Receiving band	FM
Tuning range	87.5 - 107.9 MHz
CD Player section	
Playback system	Compact Disc Digital Audio CD, CD-R, and CD-RW
DAC	8 times oversampling 1 bit D/A converter
Frequency response	100 - 20,000 Hz
iPod/iPhone dock section	
Compatibility	3G Nano, 4G Nano, 5G Nano, 6G Nano, 5G (30GB, 60GB/80GB), 4G Touch, 4G iPhone, 3G iPhone, 3GS iPhone, 4G iPhone, and 4GS iPhone.
Audio section	
Power output	2 x 3 Watts per channel
Headphone impedance	32 ohms

Legal notices

FCC Part 15

This device complies with Part 15 of the FCC Rules. Operation of this product is subject to the following two conditions: (1) this device may not cause harmful interference, and (2) this device must accept any interference received, including interference that may cause undesired operation.

This equipment has been tested and found to comply within the limits for a class B digital device, pursuant to Part 15 of the FCC Rules. These limits are designed to provide reasonable protection against harmful interference in a residential installation. This equipment generates, uses, and can radiate radio frequency energy and, if not installed and used in accordance with the instructions, may cause harmful interference to radio communications. However, there is no guarantee that interference will not occur in a particular installation. If this equipment does cause harmful interference to radio or television reception, which can be determined by turning the equipment off and on, the user is encouraged to try to correct the interference by one or more of the following measures:

- Reorient or relocate the receiving antenna.
- Increase the separation between the equipment and receiver.
- Connect the equipment into an outlet on a circuit different from that to which the receiver is connected.
- Consult the dealer or an experienced technician for help.

FCC warning

Changes or modifications not expressly approved by the party responsible for compliance with the FCC Rules could void the user's authority to operate this equipment.

Canada ICES-003 statement

This Class B digital apparatus complies with Canadian ICES-003.

INSIGNIA™

NS-BIPCD02 CD Boombox with Dock for iPhone 4/4s

ONE-YEAR LIMITED WARRANTY - INSIGNIA

Definitions:

The Distributor* of Insignia branded products warrants to you, the original purchaser of this new Insignia-branded product ("Product"), that the Product shall be free of defects in the original manufacturer of the material or workmanship for a period of one (1) year from the date of your purchase of the Product ("Warranty Period").

For this warranty to apply, your Product must be purchased in the United States or Canada from a Best Buy branded or Future Shop branded retail store or online at www.bestbuy.com, www.bestbuy.ca, or www.futureshop.ca and is packaged with this warranty statement.

How long does the coverage last?

The Warranty Period lasts for 1 year (365 days) from the date you purchased the Product. Your purchase date is printed on the receipt you received with the Product.

What does this warranty cover?

During the Warranty Period, if the original manufacture of the material or workmanship of the Product is determined to be defective by an authorized Insignia repair center or store personnel, Insignia will (at its sole option): (1) repair the Product with new or rebuilt parts; or (2) replace the Product at no charge with new or rebuilt comparable products or parts. Products and parts replaced under this warranty become the property of Insignia and are not returned to you. If service of Products or parts are required after the Warranty Period expires, you must pay all labor and parts charges. This warranty lasts as long as you own your Insignia Product during the Warranty Period. Warranty coverage terminates if you sell or otherwise transfer the Product.

How to obtain warranty service?

If you purchased the Product at a Best Buy or Future Shop retail store location, please take your original receipt and the Product to any Best Buy or Future Shop store. Make sure that you place the Product in its original packaging or packaging that provides the same amount of protection as the original packaging. If you purchased the Product from a Best Buy or Future Shop online web site (www.bestbuy.com, www.bestbuy.ca, or www.futureshop.ca), mail your original receipt and the Product to the address listed on the web site. Make sure that you put the Product in its original packaging or packaging that provides the same amount of protection as the original packaging.

To obtain warranty service, in the United States call 1-888-BESTBUY, Canada call 1-866-BESTBUY for Future Shop call 1-800-663-2275. Call agents may diagnose and correct the issue over the phone.

Where is the warranty valid?

This warranty is valid only in the United States and Canada at Best Buy or Future Shop branded retail stores or websites to the original purchaser of the product in the county where the original purchase was made.

What does the warranty not cover?

This warranty does not cover:

- Customer instruction/education
- Installation
- Set up adjustments
- Cosmetic damage
- Damage due to weather, lightning, and other acts of God, such as power surges
- Accidental damage
- Misuse
- Abuse
- Negligence

NS-BIPCD02 CD Boombox with Dock for iPhone 4/4s

INSIGNIA™

- Commercial purposes/use, including but not limited to use in a place of business or in communal areas of a multiple dwelling condominium or apartment complex, or otherwise used in a place of other than a private home.
- Modification of any part of the Product, including the antenna
- Display panel damaged by static (non-moving) images applied for lengthy periods (burn-in).
- Damage due to incorrect operation or maintenance
- Connection to an incorrect voltage or power supply
- Attempted repair by any person not authorized by Insignia to service the Product
- Products sold "as is" or "with all faults"
- Consumables, including but not limited to batteries (i.e. AA, AAA, C etc.)
- Products where the factory applied serial number has been altered or removed
- Loss or Theft of this product or any part of the product
- Display panels containing up to three (3) pixel failures (dots that are dark or incorrectly illuminated) grouped in an area smaller than one tenth (1/10) of the display size or up to five (5) pixel failures throughout the display. (Pixel based displays may contain a limited number of pixels that may not function normally.)
- Failures or Damage caused by any contact including but not limited to liquids, gels or pastes.

REPAIR REPLACEMENT AS PROVIDED UNDER THIS WARRANTY IS YOUR EXCLUSIVE REMEDY FOR BREACH OF WARRANTY. INSIGNIA SHALL NOT BE LIABLE FOR ANY INCIDENTAL OR CONSEQUENTIAL DAMAGES FOR THE BREACH OF ANY EXPRESS OR IMPLIED WARRANTY ON THIS PRODUCT, INCLUDING, BUT NOT LIMITED TO, LOST DATA, LOSS OF USE OF YOUR PRODUCT, LOST BUSINESS OR LOST PROFITS. INSIGNIA PRODUCTS MAKES NO OTHER EXPRESS WARRANTIES WITH RESPECT TO THE PRODUCT, ALL EXPRESS AND IMPLIED WARRANTIES FOR THE PRODUCT, INCLUDING, BUT NOT LIMITED TO, ANY IMPLIED WARRANTIES OF AND CONDITIONS OF MERCHANTABILITY AND FITNESS FOR A PARTICULAR PURPOSE, ARE LIMITED IN DURATION TO THE WARRANTY PERIOD SET FORTH ABOVE AND NO WARRANTIES, WHETHER EXPRESS OR IMPLIED, WILL APPLY AFTER THE WARRANTY PERIOD. SOME STATES, PROVINCES AND JURISDICTIONS DO NOT ALLOW LIMITATIONS ON HOW LONG AN IMPLIED WARRANTY LASTS, SO THE ABOVE LIMITATION MAY NOT APPLY TO YOU. THIS WARRANTY GIVES YOU SPECIFIC LEGAL RIGHTS, AND YOU MAY ALSO HAVE OTHER RIGHTS, WHICH VARY FROM STATE TO STATE OR PROVINCE TO PROVINCE.

Contact Insignia:

For customer service please call 1-877-467-4289

www.insigniaproducts.com

INSIGNIA is a trademark of Best Buy and its affiliated companies.

Registered in some countries.

Distributed by Best Buy Purchasing, LLC

7601 Penn Ave South, Richfield, MN 55423 U.S.A.

©2014 Best Buy. All rights reserved.

Made in China

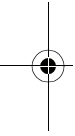
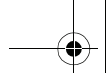

INSIGNIA™

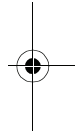

www.insigniaproducts.com
1-877-467-4289 (U.S. and Canada) or 01-800-926-3000 (Mexico)

INSIGNIA is a trademark of Best Buy and its affiliated companies.
Registered in some countries.
Distributed by Best Buy Purchasing, LLC
7601 Penn Ave South, Richfield, MN 55423 U.S.A.
©2014 Best Buy. All rights reserved.
Made in China.

V3 ENGLISH
14-0811

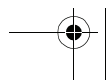
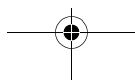

Free Manuals Download Website

<http://myh66.com>

<http://usermanuals.us>

<http://www.somanuals.com>

<http://www.4manuals.cc>

<http://www.manual-lib.com>

<http://www.404manual.com>

<http://www.luxmanual.com>

<http://aubethermostatmanual.com>

Golf course search by state

<http://golfingnear.com>

Email search by domain

<http://emailbydomain.com>

Auto manuals search

<http://auto.somanuals.com>

TV manuals search

<http://tv.somanuals.com>