

INSIGNIA™

External TTL Flash for Canon™

NS-DXFL2C



NS-DXFL2C

External TTL Flash for Canon™

Contents

Welcome	2
Important safety instructions	3
Features	3
Package contents	3
Front view	4
Back view	5
Setting up your flash	6
Installing the batteries	6
Attaching the flash	7
Removing the flash	8
Turning on the flash	8
Using your flash	9
Using your flash	9
Fully automatic flash shooting	9
Using Flash Exposure Compensation (FEC)	9
Using the Flash Exposure Lock (FEL)	9
Using S1/S2 slave triggering mode	11
Using bounce flash	12
Setting the flash's custom functions through the camera	15
Over-Temperature Protection	15
Troubleshooting	16
Specifications	17
Legal notices	18
ONE-YEAR LIMITED WARRANTY - INSIGNIA	19

Welcome

Congratulations on your purchase of a high-quality Insignia product. Your NS-DXFL2C E-TTL II compatible flash represents the state-of-the-art in electronic flash design and is designed for reliable and trouble-free performance.

Important safety instructions

- 1 Read these instructions.
- 2 Keep these instructions.
- 3 Heed all warnings.
- 4 Follow all instructions.
- 5 Do not use this apparatus in the water.
- 6 Clean only with a dry cloth.
- 7 Do not block any ventilation openings. Install in accordance with the manufacturer's instructions.
- 8 Only use attachments/accessories specified by the manufacturer.
- 9 Refer all servicing to qualified service personnel. Servicing is required when the apparatus has been damaged in any way, liquid has been spilled or objects have fallen into the apparatus, the apparatus has been exposed to rain or moisture, does not operate normally, or has been dropped.
- 10 To reduce the risk of fire or electric shock, do not expose this device to rain, moisture, dripping, or splashing, and no objects filled with liquids, such as vases, shall be placed on it.

Features

Package contents

- E-TTL II Flash
- Mini stand
- Protective carrying bag
- User Guide

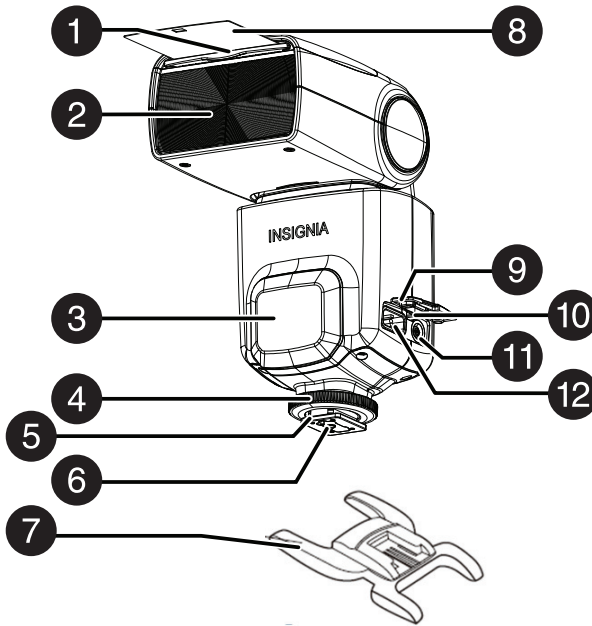

Front view

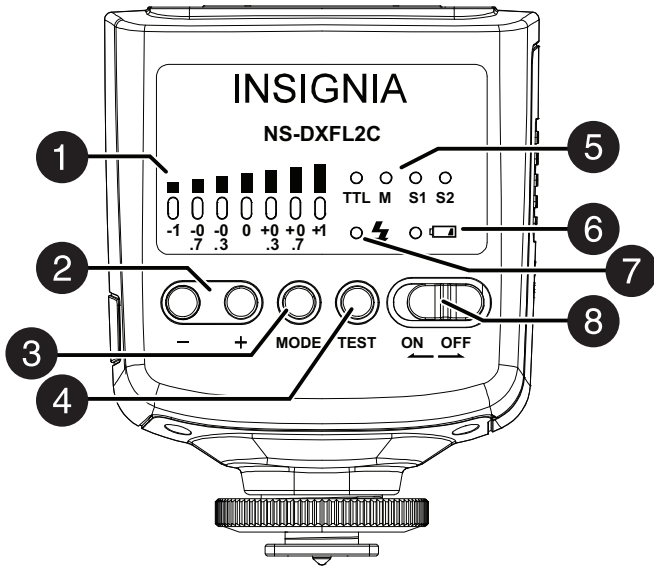

#	Item	Description
1	Built-in wide angle panel	Use to spread the flash light over a wider angle or to reduce its direct intensity.
2	Flash head	Provides the light (flash) for the photograph.
3	AF-assist beam emitter	Projects a red light beam to help the camera focus in low-light settings.
4	Locking knob	Tighten this knob to secure the flash to the camera.
5	Mounting foot	Connect to the camera's hot shoe to mount and connect the flash on the camera. Also connects to the mini stand to use the flash in slave mode.
6	Hot shoe contact	Provides electrical contact to a camera's hot shoe.
7	Mini stand	Use to set up the flash away from the camera to use in slave mode.
8	White reflector card	Pull out to create a more diffused light and a catchlight in a subject's eye for portrait shots.
9	Power port cover	Covers and protects the external power port.
10	PC sync terminal	Connect a PC sync cord (not included) to this jack to control the flash remotely.
11	PC sync terminal cover	Covers the PC sync terminal.
12	External power port	Accessory port for an external power pack (not provided).

Back view



#	Item	Description
1	Power level indicator	Shows the power level selected.
2	Brightness/FEC +/- button	Press to lower or raise the brightness or Flash Exposure Compensation level.
3	MODE button	Press repeatedly to change the flash mode.
4	TEST button	Press to fire a test flash.
5	TTL/M/S1/S2 indicators	Indicates the current mode of the flash.
6	 (battery level indicator)	Lights when the battery level is low.
7	 (flash-ready indicator)	Lights when the flash is ready.
8	ON/OFF switch	Slide to the left to turn the flash on, or to the right to turn the flash off.

Setting up your flash

Installing the batteries

Cautions

- Use only Alkaline or NiMH AA batteries.
- The batteries may become hot after firing many flashes continuously.

Notes

- Make sure that all four batteries are the same brand and type.
- When replacing the batteries, replace all four at one time.
- Batteries are not included with this flash.

- 1 Open the battery compartment cover by pressing it with your thumb, sliding the compartment down, then lifting it open.

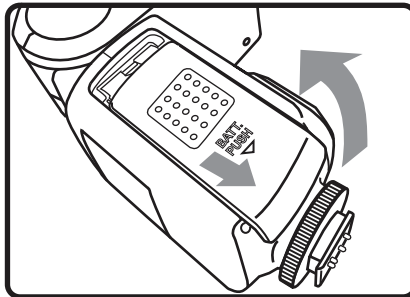

- 2 Insert four (4) AA batteries (not included). Make sure that the + and - match what is indicated in the compartment.

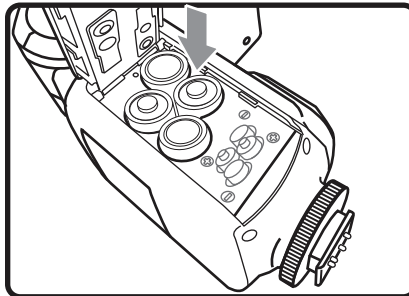

- 3 Close the battery compartment cover and slide it into place.

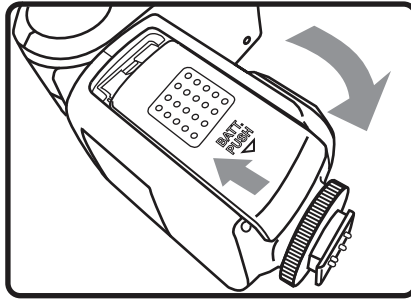

Recycle time*	Flash count*
Approx. 0.1 – 5 seconds	Approx. 100 - 1500 flashes

* Based on four (4) new, AA alkaline batteries.

Attaching the flash

- 1 Turn the camera and the flash off and loosen the locking knob on the flash.
- 2 With the flash facing toward the front of the camera, slide the flash's mounting foot all the way into the camera's hot shoe.

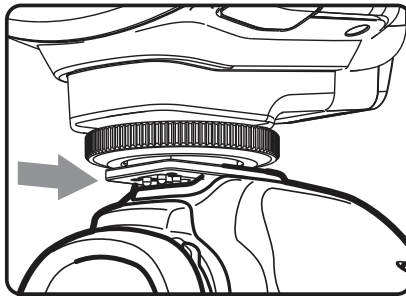

- 3 Rotate the locking knob on the mounting foot until it's tight. Do not overtighten.

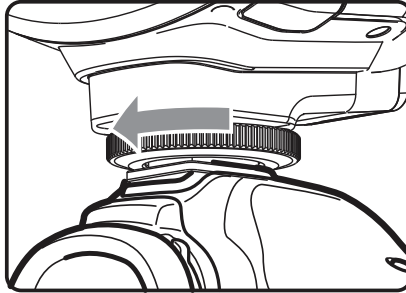

Removing the flash

- Make sure that the camera and flash are turned off, then remove the flash from the camera by loosening the locking knob and sliding it off of the camera's hot shoe.

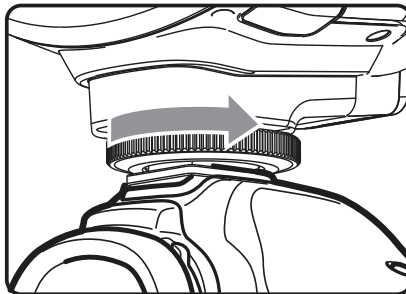

Turning on the flash

- 1 Slide the power switch to **ON**. The flash begins charging. The flash zoom mechanism also resets. This generates some movement sounds and is normal.

Note

If the battery icon  blinks on the back of the flash head, the battery power is low and the flash stops charging. Change the batteries immediately.

- 2 When the flash-ready indicator  turns red, the external TTL flash is fully charged and ready for firing.

Note

To test the flash, press the **TEST** button.

Caution

Do not look closely at the flash window or point it at someone's eyes at close range.

Using your flash

Fully automatic flash shooting

Setting the camera's shooting mode to **P** (Program AE) or **AUTO** (Full Auto) makes automatic shooting as easy as normal AE shooting.

- 1 Set the flash to E-TTL auto flash mode by pressing the **MODE** button repeatedly until the "TTL" indicator lights on the back of the flash.
- 2 To focus the camera, press the shutter button halfway. The shutter speed and aperture is displayed in the camera viewfinder. Make sure that the  icon is shown in the camera viewfinder.
Before the shot is recorded by the camera, the flash fires a pre-flash. This is immediately followed by the main flash.

Using Flash Exposure Compensation (FEC)

Using FEC, this flash can adjust from -1 to +1 in 1/3rd stops. This is useful in situations where minor adjustments of the TTL system are needed, based on the environment.

Notes

- The flash exposure compensation amount can only be set in TTL mode.
- If the camera has also set the flash exposure compensation amount, the final flash amount is determined by the combined effects of the two amounts.

- 1 Check the indicator light on the back of the flash to make sure that the flash is set to TTL mode.
- 2 Set the flash exposure compensation number by pressing the - or + button.
- 3 To cancel flash exposure compensation, set the number to "+0.0".

Using the Flash Exposure Lock (FEL)

The FE (flash exposure) lock locks the correct flash exposure setting into the flash for any part of the scene you select.

- 1 Set the flash to E-TTL II auto flash mode by pressing the **MODE** button repeatedly until the "TTL" indicator lights on the back of the flash, then focus on the subject.

- 2 Place the selected subject in the center of the viewfinder, then press the **FEL** button on the camera. If your camera does not have an **FEL** button, press the ***** button on the camera. The camera flash fires a preflash and the required flash output for the subject is retained in memory.

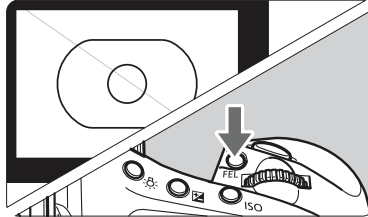

“FEL” is displayed in the camera’s viewfinder for 0.5 seconds.

Each time you press the **FEL** button, a preflash is fired, a new flash exposure setting is locked into memory.

Notes

- If the TTL mode is not selected, the FE lock cannot be set.
- If the subject is too small, the FE lock might not be very effective.
- If the subject is too far away and underexposure is possible, the  blinks in the camera’s viewfinder. Move closer to the subject and try the FE lock again.
- The **FEL** button is on the camera. The position of the button may vary, based on the camera model you are using. Refer to your camera instruction manual.

- 3 Exit FEL mode by pressing the **MODE** button on the flash until the **FEL** indicator turns off.

Using manual flash (M)

The flash output is adjustable from full brightness to 1/64th brightness in 1/3rd step increments. Use a hand-held flash meter to determine the required flash output to obtain a correct flash exposure when using manual flash.

- 1 Press the **MODE** button repeatedly until the **M** indicator lights on the back of the flash.
- 2 Press the **+** button to set the brightness. The levels are increased, in order, from 1/64, 1/32, 1/16, 1/8, 1/4, 1/2, and 1/1. Press the **-** button to decrease the brightness. The **-1** indicator on the back of the flash corresponds to the 1/64 power and the **+1** corresponds to the 1/1 power level.

Using S1/S2 slave triggering mode

Note

For information on setting the slave auto power off time, see “Setting the flash’s custom functions through the camera” on page 15.

S1 slave triggering mode

In this mode, the flash unit functions as a slave flash for creating multiple lighting effects. It should be used in manual flash mode. In S1 mode, the flash unit fires at the same time as the master flash fires.

S2 slave triggering mode

This mode is also called “Preflash Cancel.” In this mode, the flash unit ignores a single “preflash” from the master flash and only fires in response to the second, actual flash from the master. Therefore, this mode can be used when using a TTL master flash on the camera.

Notes

- Slave triggering modes are not supported when the “red-eye reduction” function is initiated by the master flash (either camera pop-up flash or external on-camera flash) and when the master flash uses the modeling flash function.
- In either slave triggering mode the flash output level is only manually adjustable.

Setting S1/S2 slave trigger mode

To enter S1/S2 mode from the main mode, press the **MODE** button repeatedly until the S1 or S2 indicator lights on the back of the flash.

The flash output setting in slave triggering mode is the same as that in manual mode. Press the – button or + button to change the brightness.

You can use your mini stand to set the flash away from the camera in S1 or S2 slave trigger mode.

- 1 Slide the flash hot shoe onto the mini stand.
- 2 Rotate the locking knob on the mounting foot until it’s tight. Do not overtighten.
- 3 Place the flash in the location you want.

Note

Make sure that the optic slave sensor has a clear line of sight to the camera’s flash or the flash is connected to the camera via a PC sync cable.

Using bounce flash

By pointing the flash head toward a wall or ceiling, the flash bounces off of the surface before illuminating the subject. This can soften shadows behind the subject for a more natural-looking shot. This is called bounce flash.

- Hold the flash head and turn it to the angle you want.

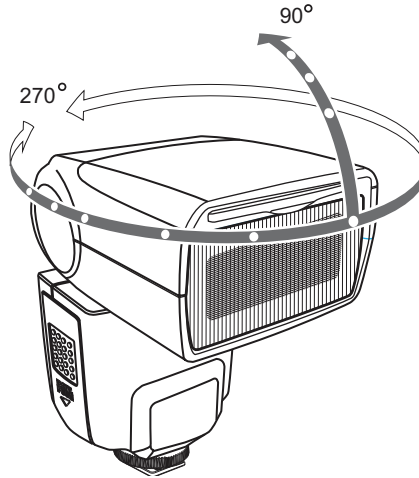

Notes

- If the wall or ceiling is too far away, the bounced flash might be too weak and may result in underexposure.
- The wall or ceiling should be a plain, white color for high reflectance. If the bounce surface is not white, the surface color may affect the picture.

Creating a catchlight

With the white reflector card, you can create a catchlight (a light source that causes a specular highlight) in the subject's eyes to add life to their facial expression.

- 1 Point the flash head upward 90°.
- 2 Pull out the wide angle panel on the front of the flash head. The white reflector card comes out at the same time.

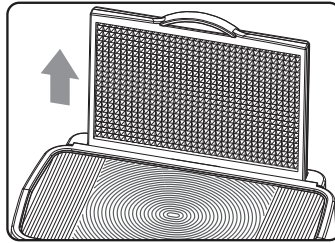

- 3 Push the wide angle panel back in, leaving the white reflector card out.

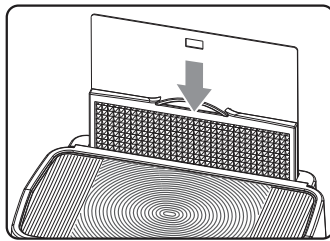

- 4 Hold the flash head and turn it to the angle you want.

Notes

- Point the flash head straight ahead or upward by 90°. The catchlight does not appear in the subject's eyes if you swing the flash head left or right.
- For maximum catchlight effect, stay approximately 4.9 ft (1.5 m) away from the subject.

Using the wide angle panel

Use the wide angle panel to spread light over a wider angle or to reduce its intensity.

- 1 Pull out the wide angle panel on the front of the flash head. The white reflector card comes out at the same time.

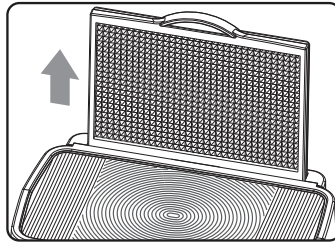

- 2 Push the white reflector card back in, leaving the wide angle panel out.
- 3 Pivot the wide angle panel down over the flash head. The flash coverage is extended to 14 mm.

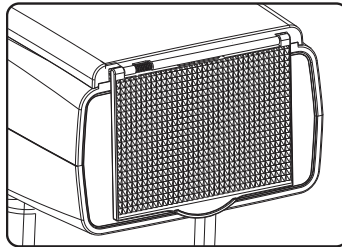

Notes

- If you use bounce flash with the wide angle panel in place, the subject is illuminated by both the bounce flash and direct flash, which may look unnatural.
- Pull out the wide angle panel gently. Using excessive force may detach the wide panel from the flash head.
- You can see whether the wide panel is pulled out or pushed in through the camera's menu. Open the camera's menu and select **Flash Control**, then select **External flash function setting**, then **Zoom**. The wide panel contents are shown.

Setting the flash's custom functions through the camera

You can set the flash's custom functions through your camera. To do this, open the camera's menu and select **Flash control**, then open the **External flash C.Fn** setting lists. The custom functions can be set as follows:

1. C.Fn.01 Auto power off
 - 0—The auto power off function takes effect and the flash will enter sleep mode after a period of idle operation.
 - 1—The auto power off function is off and the flash will not enter sleep mode after a period of idle operation
2. C.Fn.10 Slave auto power off timer
 - 0—The slave auto power off time will be set as 60 minutes.
 - 1—The slave auto power off time will be set as 30 minutes.

Over-Temperature Protection





- To avoid overheating and damaging the flash head, allow the camera to rest after 20 continuous flashes.
- If you fire too many flashes, the inner over-temperature protection function may be activated and make the recycling time about 10 to 15 seconds. If this occurs, allow a rest time of about 10 minutes, and the flash unit returns to normal.

Error codes

The flash has a built-in protection mechanism in case of a failure. If the system detects a problem the power level indicator blinks:

Blinking power level indicator	Meaning
1/64	A failure occurred in the recharging system and the flash cannot fire. Turn the flash power switch OFF, then ON again. If the problem persists, it will require service.
1/32	The system is too hot. Allow a rest time of 10 minutes.
1/16	The flash tube voltage is too high. Service is required.

Troubleshooting

Problem	Solution
The flash does not charge	<ul style="list-style-type: none"> • Make sure that the batteries are installed in the correct direction. • If  appears and blinks on the back of the flash, replace the batteries immediately. • Install the batteries even when using an external power source. • Make sure that you are using Alkaline or NiMH AA batteries.
The flash does not fire	<ul style="list-style-type: none"> • Make sure that the flash's mounting foot is securely connected to the camera's hot shoe. • Wait until the flash is fully charged and the flash ready indicator  lights red. • Make sure that the electrical contacts on the mounting foot and hot shoe are clean. • Make sure that the camera's flash is turned on and the mode is active. • If the flash ready indicator  does not light, replace the batteries. • If  appears and blinks on the back of the flash, replace the batteries immediately. • If the flash is used in slave mode, make sure that the master flash on the camera is turned on and active. • If the flash is used in slave mode, make sure that there is a clear line of sight between the optic slave sensor and the camera's flash. • If using a PC sync cable, make sure your connections are secure. • The over-temperature protection may have disabled the flash temporarily. Wait for 10 minutes and try again.
The power turns off by itself	<ul style="list-style-type: none"> • When the flash is set as the master unit, the flash enters sleep mode after 90 seconds of inactivity. Press the shutter button halfway or press the TEST button to wake it up. • When the flash is set as the slave unit, the flash enters sleep mode after 60 minutes of inactivity. Press the TEST button to wake it up.
Auto zoom does not work	<ul style="list-style-type: none"> • Make sure that the camera is not set to manual zoom mode. • Make sure that the flash's mounting foot is securely connected to the camera's hot shoe. • If  appears and blinks on the back of the flash, replace the batteries immediately.
The picture is underexposed or overexposed	<ul style="list-style-type: none"> • If there is a highly reflective object (such as glass or a mirror) in the picture, use the FE lock. • If you are using the high-speed sync, make sure that the subject is within the effective flash range displayed. • If you are using Manual Flash mode, set the flash to TTL or modify the flash output. Make sure that the flash exposure compensation is set to zero.
Photos have dark corners or only parts of the target subject are illuminated	<ul style="list-style-type: none"> • Check the flash coverage you set. This flash unit has flash coverage between 24 and 105 mm (lens focal length), which fits medium-format cameras. Pull the wide panel out to extend the flash coverage.

Specifications

Specifications are subject to change without notice.

Compatible cameras	Canon EOS series cameras (E-TTL II autoflash)
Guide No.	26/85 meters/feet at ISO 100
Flash mode	TTL, M, S1, S2
Vertical rotation angle	-10 to 90 degrees
Horizontal rotation angle	0 to 270 degrees
EXPOSURE CONTROL	
Exposure control system	E-TTL II autoflash, manual flash
Flash Exposure Compensation (FEC)	Manual - ±1 stop in 1/3 stop increments
FE lock	Via the FEL button or ✳ button on the camera
Sync mode	First-curtain sync
Optic slave triggering	S1 and S2
FLASH RECYCLING (WITH AA ALKALINE BATTERIES)	
Recycling time	Normal flash approximately 0.1 to 5 seconds
Flash-ready indicator	Red indicator light
POWER SOURCE	
Internal power	4 AA Alkaline or Ni-MHbatteries
Battery life (approx. flash count)	100-1500 flashes (with AA alkaline batteries)
Power saving	Powers off after about 1.5 min. of inactivity
COLOR TEMPERATURE	5600±200K
DIMENSIONS (HxWxD)	7.4 × 2.9 × 2.3 in. (188 × 73 × 58 mm)
WEIGHT	11.7 oz. (332 g) (flash only, excluding batteries)

Legal notices

FCC Part 15

This device complies with Part 15 of the FCC Rules. Operation of this product is subject to the following two conditions: (1) this device may not cause harmful interference, and (2) this device must accept any interference received, including interference that may cause undesired operation.

This equipment has been tested and found to comply within the limits for a class B digital device, pursuant to Part 15 of the FCC Rules. These limits are designed to provide reasonable protection against harmful interference in a residential installation. This equipment generates, uses, and can radiate radio frequency energy and, if not installed and used in accordance with the instructions, may cause harmful interference to radio communications. However, there is no guarantee that interference will not occur in a particular installation. If this equipment does cause harmful interference to radio or television reception, which can be determined by turning the equipment off and on, the user is encouraged to try to correct the interference by one or more of the following measures:

- Reorient or relocate the receiving antenna.
- Increase the separation between the equipment and receiver.
- Connect the equipment into an outlet on a circuit different from that to which the receiver is connected.
- Consult the dealer or an experienced radio/TV technician for help.

FCC warning

Changes or modifications not expressly approved by the party responsible for compliance with the FCC Rules could void the user's authority to operate this equipment.

ONE-YEAR LIMITED WARRANTY - INSIGNIA

Definitions:

The Distributor* of Insignia branded products warrants to you, the original purchaser of this new Insignia-branded product ("Product"), that the Product shall be free of defects in the original manufacturer of the material or workmanship for a period of one (1) year from the date of your purchase of the Product ("Warranty Period").

For this warranty to apply, your Product must be purchased in the United States or Canada from a Best Buy branded or Future Shop branded retail store or online at www.bestbuy.com, www.bestbuy.ca, or www.futureshop.ca and is packaged with this warranty statement.

How long does the coverage last?

The Warranty Period lasts for 1 year (365 days) from the date you purchased the Product. Your purchase date is printed on the receipt you received with the Product.

What does this warranty cover?

During the Warranty Period, if the original manufacture of the material or workmanship of the Product is determined to be defective by an authorized Insignia repair center or store personnel, Insignia will (at its sole option): (1) repair the Product with new or rebuilt parts; or (2) replace the Product at no charge with new or rebuilt comparable products or parts. Products and parts replaced under this warranty become the property of Insignia and are not returned to you. If service of Products or parts are required after the Warranty Period expires, you must pay all labor and parts charges. This warranty lasts as long as you own your Insignia Product during the Warranty Period. Warranty coverage terminates if you sell or otherwise transfer the Product.

How to obtain warranty service?

If you purchased the Product at a Best Buy or Future Shop retail store location, please take your original receipt and the Product to any Best Buy or Future Shop store. Make sure that you place the Product in its original packaging or packaging that provides the same amount of protection as the original packaging. If you purchased the Product from a Best Buy or Future Shop online web site (www.bestbuy.com, www.bestbuy.ca, or www.futureshop.ca), mail your original receipt and the Product to the address listed on the web site. Make sure that you put the Product in its original packaging or packaging that provides the same amount of protection as the original packaging.

To obtain warranty service, in the United States call 1-888-BESTBUY, Canada call 1-866-BESTBUY for Future Shop call 1-800-663-2275. Call agents may diagnose and correct the issue over the phone.

Where is the warranty valid?

This warranty is valid only in the United States and Canada at Best Buy or Future Shop branded retail stores or websites to the original purchaser of the product in the county where the original purchase was made.

What does the warranty not cover?

This warranty does not cover:

- Customer instruction/education
- Installation
- Set up adjustments
- Cosmetic damage
- Damage due to weather, lightning, and other acts of God, such as power surges
- Accidental damage
- Misuse
- Abuse
- Negligence

- Commercial purposes/use, including but not limited to use in a place of business or in communal areas of a multiple dwelling condominium or apartment complex, or otherwise used in a place of other than a private home.
- Modification of any part of the Product, including the antenna
- Display panel damaged by static (non-moving) images applied for lengthy periods (burn-in).
- Damage due to incorrect operation or maintenance
- Connection to an incorrect voltage or power supply
- Attempted repair by any person not authorized by Insignia to service the Product
- Products sold "as is" or "with all faults"
- Consumables, including but not limited to batteries (i.e. AA, AAA, C etc.)
- Products where the factory applied serial number has been altered or removed
- Loss or Theft of this product or any part of the product
- Display panels containing up to three (3) pixel failures (dots that are dark or incorrectly illuminated) grouped in an area smaller than one tenth (1/10) of the display size or up to five (5) pixel failures throughout the display. (Pixel based displays may contain a limited number of pixels that may not function normally.)
- Failures or Damage caused by any contact including but not limited to liquids, gels or pastes.

REPAIR REPLACEMENT AS PROVIDED UNDER THIS WARRANTY IS YOUR EXCLUSIVE REMEDY FOR BREACH OF WARRANTY. INSIGNIA SHALL NOT BE LIABLE FOR ANY INCIDENTAL OR CONSEQUENTIAL DAMAGES FOR THE BREACH OF ANY EXPRESS OR IMPLIED WARRANTY ON THIS PRODUCT, INCLUDING, BUT NOT LIMITED TO, LOST DATA, LOSS OF USE OF YOUR PRODUCT, LOST BUSINESS OR LOST PROFITS. INSIGNIA PRODUCTS MAKES NO OTHER EXPRESS WARRANTIES WITH RESPECT TO THE PRODUCT, ALL EXPRESS AND IMPLIED WARRANTIES FOR THE PRODUCT, INCLUDING, BUT NOT LIMITED TO, ANY IMPLIED WARRANTIES OF AND CONDITIONS OF MERCHANTABILITY AND FITNESS FOR A PARTICULAR PURPOSE, ARE LIMITED IN DURATION TO THE WARRANTY PERIOD SET FORTH ABOVE AND NO WARRANTIES, WHETHER EXPRESS OR IMPLIED, WILL APPLY AFTER THE WARRANTY PERIOD. SOME STATES, PROVINCES AND JURISDICTIONS DO NOT ALLOW LIMITATIONS ON HOW LONG AN IMPLIED WARRANTY LASTS, SO THE ABOVE LIMITATION MAY NOT APPLY TO YOU. THIS WARRANTY GIVES YOU SPECIFIC LEGAL RIGHTS, AND YOU MAY ALSO HAVE OTHER RIGHTS, WHICH VARY FROM STATE TO STATE OR PROVINCE TO PROVINCE.

Contact Insignia:

For customer service please call 1-877-467-4289

www.insigniaproducts.com

INSIGNIA is a trademark of Best Buy and its affiliated companies.

Registered in some countries.

Distributed by Best Buy Purchasing, LLC

7601 Penn Ave South, Richfield, MN 55423 U.S.A.

©2014 Best Buy. All rights reserved.

Made in China

INSIGNIA™

www.insigniaproducts.com
1-877-467-4289 (U.S. and Canada) or 01-800-926-3000 (Mexico)

INSIGNIA is a trademark of Best Buy and its affiliated companies.

Registered in some countries.

Distributed by Best Buy Purchasing, LLC
7601 Penn Ave South, Richfield, MN 55423 U.S.A.

©2014 Best Buy. All rights reserved.

Made in China.

V3 ENGLISH
14-1135

Free Manuals Download Website

<http://myh66.com>

<http://usermanuals.us>

<http://www.somanuals.com>

<http://www.4manuals.cc>

<http://www.manual-lib.com>

<http://www.404manual.com>

<http://www.luxmanual.com>

<http://aubethermostatmanual.com>

Golf course search by state

<http://golfingnear.com>

Email search by domain

<http://emailbydomain.com>

Auto manuals search

<http://auto.somanuals.com>

TV manuals search

<http://tv.somanuals.com>