

# Integra

## Contents

Before Using Your DVD Player 2

DVD Player

# DPS-5.3

Instruction Manual

Getting Started

Basic Playback

Advanced Playback

Function Setup

Others

Thank you for purchasing the Integra DVD Player.  
Please read this manual thoroughly before making connections and plugging in the unit. Following the instructions in this manual will enable you to obtain optimum performance and listening enjoyment from your new Player. Please retain this manual for future reference.



**WARNING:**

TO REDUCE THE RISK OF FIRE OR ELECTRIC SHOCK, DO NOT EXPOSE THIS APPLIANCE TO RAIN OR MOISTURE.

**CAUTION:**

TO REDUCE THE RISK OF ELECTRIC SHOCK, DO NOT REMOVE COVER (OR BACK). NO USER-SERVICEABLE PARTS INSIDE. REFER SERVICING TO QUALIFIED SERVICE PERSONNEL.



**WARNING**  
RISK OF ELECTRIC SHOCK  
DO NOT OPEN

**AVIS**  
RISQUE DE CHOC ELECTRIQUE  
NE PAS OUVRIR



The lightning flash with arrowhead symbol, within an equilateral triangle, is intended to alert the user to the presence of uninsulated "dangerous voltage" within the product's enclosure that may be of sufficient magnitude to constitute a risk of electric shock to persons.



The exclamation point within an equilateral triangle is intended to alert the user to the presence of important operating and maintenance (servicing) instructions in the literature accompanying the appliance.

# Important Safeguards

1. **Read Instructions** – All the safety and operating instructions should be read before the appliance is operated.
2. **Retain Instructions** – The safety and operating instructions should be retained for future reference.
3. **Heed Warnings** – All warnings on the appliance and in the operating instructions should be adhered to.
4. **Follow Instructions** – All operating and use instructions should be followed.
5. **Cleaning** – Unplug the appliance from the wall outlet before cleaning. The appliance should be cleaned only as recommended by the manufacturer.
6. **Attachments** – Do not use attachments not recommended by the appliance manufacturer as they may cause hazards.
7. **Water and Moisture** – Do not use the appliance near water –for example, near a bath tub, wash bowl, kitchen sink, or laundry tub; in a wet basement; or near a swimming pool; and the like.
8. **Accessories** – Do not place the appliance on an unstable cart, stand, tripod, bracket, or table. The appliance may fall, causing serious injury to a child or adult, and serious damage to the appliance. Use only with a cart, stand, tripod, bracket, or table recommended by the manufacturer, or sold with the appliance. Any mounting of the appliance should follow the manufacturer's instructions, and should use a mounting accessory recommended by the manufacturer. PORTABLE CART WARNING
9. An appliance and cart combination should be moved with care. Quick stops, excessive force, and uneven surfaces may cause the appliance and cart combination to overturn.
 



S3125A
10. **Ventilation** – Slots and openings in the cabinet are provided for ventilation and to ensure reliable operation of the appliance and to protect it from overheating, and these openings must not be blocked or covered. The openings should never be blocked by placing the appliance on a bed, sofa, rug, or other similar surface. The appliance should not be placed in a built-in installation such as a bookcase or rack unless proper ventilation is provided. There should be free space of at least 5 cm (2 in.) and an opening behind the appliance.
11. **Power Sources** – The appliance should be operated only from the type of power source indicated on the marking label. If you are not sure of the type of power supply to your home, consult your appliance dealer or local power company.
12. **Grounding or Polarization** – The appliance may be equipped with a polarized alternating current line plug (a plug having one blade wider than the other). This plug will fit into the power outlet only one way. This is a safety feature. If you are unable to insert the plug fully into the outlet, try reversing the plug. If the plug should still fail to fit, contact your electrician to replace your obsolete outlet. Do not defeat the safety purpose of the polarized plug.
13. **Power-Cord Protection** – Power-supply cords should be routed so that they are not likely to be walked on or pinched by items placed upon or against them, paying particular attention to cords at plugs, convenience receptacles, and the point where they exit from the appliance.
14. **Lightning** – For added protection for the appliance during a lightning storm, or when it is left unattended and unused for long periods of time, unplug it from the wall outlet and disconnect the antenna or cable system. This will prevent damage to the appliance due to lightning and power-line surges.
15. **Overloading** – Do not overload wall outlets, extension cords, or integral convenience receptacles as this can result in a risk of fire or electric shock.
16. **Object and Liquid Entry** – Never push objects of any kind into the appliance through openings as they may touch dangerous voltage points or short-out parts that could result in a fire or electric shock. Never spill liquid of any kind on the appliance.
17. **Servicing** – Do not attempt to service the appliance yourself as opening or removing covers may expose you to dangerous voltage or other hazards. Refer all servicing to qualified service personnel.
18. **Damage Requiring Service** – Unplug the appliance from the wall outlet and refer servicing to qualified service personnel under the following conditions:
  - A. When the power-supply cord or plug is damaged,
  - B. If liquid has been spilled, or objects have fallen into the appliance,
  - C. If the appliance has been exposed to rain or water,
  - D. If the appliance does not operate normally by following the operating instructions. Adjust only those controls that are covered by the operating instructions as an improper adjustment of other controls may result in damage and will often require extensive work by a qualified technician to restore the appliance to its normal operation,
  - E. If the appliance has been dropped or damaged in any way, and
  - F. When the appliance exhibits a distinct change in performance – this indicates a need for service.
19. **Replacement Parts** – When replacement parts are required, be sure the service technician has used replacement parts specified by the manufacturer or have the same characteristics as the original part. Unauthorized substitutions may result in fire, electric shock, or other hazards.
20. **Safety Check** – Upon completion of any service or repairs to the appliance, ask the service technician to perform safety checks to determine that the appliance is in proper operation condition.
21. **Wall or Ceiling Mounting** – The appliance should be mounted to a wall or ceiling only as recommended by the manufacturer.
22. **Heat** – The appliance should be situated away from heat sources such as radiators, heat registers, stoves, or other appliances (including amplifiers) that produce heat.
23. **Liquid Hazards** – The appliance should not be exposed to dripping or splashing and no objects filled with liquids, such as vases should be placed on the appliance.

# Precautions

This unit contains a semiconductor laser system and is classified as a "CLASS 1 LASER PRODUCT". So, to use this model properly, read this Instruction Manual carefully. In case of any trouble, please contact the store where you purchased the unit. To prevent being exposed to the laser beam, do not try to open the enclosure.

## **DANGER:**

VISIBLE AND INVISIBLE LASER RADIATION WHEN OPEN AND INTERLOCK FAILED OR DEFEATED. DO NOT STARE INTO BEAM.

## **CAUTION:**

THIS PRODUCT UTILIZES A LASER. USE OF CONTROLS OR ADJUSTMENTS OR PERFORMANCE OF PROCEDURES OTHER THAN THOSE SPECIFIED HEREIN MAY RESULT IN HAZARDOUS RADIATION EXPOSURE.

The label on the right is applied on the rear panel except for USA and Canadian models.



1. This unit is a CLASS 1 LASER PRODUCT and employs a laser inside the cabinet.
2. To prevent the laser from being exposed, do not remove the cover. Refer servicing to qualified personnel.

## **For U.S. model**

The laser is covered by a housing which prevents exposure during operation or maintenance. However, this product is classified as a Laser Product by CDRH (Center for Devices and Radiological Health) which is a department of the Food and Drug Administration. According to their regulations 21 CFR section 1002.30, all manufacturers who sell Laser Products must maintain records of written communications between the manufacturer, dealers and customers concerning radiation safety. If you have any complaints about instructions or explanations affecting the use of this product, please feel free to write to the address on the back page of this manual. When you write us, please include the model number and serial number of your unit.

In compliance with Federal Regulations, the certification, identification and the period of manufacture are indicated on the rear panel.

## **FCC INFORMATION FOR USER**

### **CAUTION:**

The user changes or modifications not expressly approved by the party responsible for compliance could void the user's authority to operate the equipment.

### **NOTE:**

This equipment has been tested and found to comply with the limits for a Class B digital device, pursuant to Part 15 of the FCC Rules. These limits are designed to provide reasonable protection against harmful interference in a residential installation. This equipment generates, uses and can radiate radio frequency energy and, if not installed and used in accordance with the instructions, may cause harmful interference to radio communications. However, there is no guarantee that interference will not occur in a particular installation. If this equipment does cause harmful interference to radio or television reception, which can be determined by turning the equipment off and on, the user is encouraged to try to correct the interference by one or more of the following measures:

- Reorient or relocate the receiving antenna.
- Increase the separation between the equipment and receiver.
- Connect the equipment into an outlet on a circuit different from that to which the receiver is connected.
- Consult the dealer or an experienced radio/TV technician for help.

## **For Canadian model**

**NOTE:** This class B digital apparatus complies with Canadian ICES-003.

**For models having a power cord with a polarized plug:**

**CAUTION:** TO PREVENT ELECTRIC SHOCK, MATCH WIDE BLADE OF PLUG TO WIDE SLOT, FULLY INSERT.

**Modèle pour les Canadien**

**REMARQUE:** Cet appareil numérique de la classe B est conforme à la norme NMB-003 du Canada.

**Sur les modèles dont la fiche est polarisée:**

**ATTENTION:** POUR ÉVITER LES CHOCS ÉLECTRIQUES, INTRODUIRE LA LAME LA PLUS LARGE DE LA FICHE DANS LA BORNE CORRESPONDANTE DE LA PRISE ET POUSSER JUSQU'AU FOND.

# Precautions

## 1. Regional Restriction Codes (Region Number)

Regional restriction codes are built into DVD Players and DVD-Video media for each sales region. If the regional code of the DVD Player does not match one of the regional codes on the DVD-Video, playback is not possible. The regional number can be found on the rear panel of the DVD Player. (e.g.  for Region 1)

## 2. About This Manual

This manual explains the basic procedures for operating the DVD Player. Some DVD-Video discs do not support the full potential of the DVD technology. Your DVD Player may therefore not respond to all operating commands. Refer to instruction notes on discs.

A "Ⓞ" mark may appear on the TV screen during operation. It means that the operation is not permitted by the DVD Player or the disc.

## 3. Recording Copyright

Recording of copyrighted material for other than personal use is illegal without permission of the copyright holder.

## 4. Power

### WARNING

BEFORE PLUGGING IN THE UNIT FOR THE FIRST TIME, READ THE FOLLOWING SECTION CAREFULLY.

The voltage of the available power supply differs according to country or region. Be sure that the power supply voltage of the area where the unit will be used meets the required voltage (e.g., AC 120 V, 60 Hz) written on the rear panel.

## 5. Do not touch the unit with wet hands

Do not handle the unit or power cord when your hands are wet or damp. If water or any other liquid enters the case, take the unit to an authorized service center for inspection.

## 6. Location of the unit

- Place the unit in a well-ventilated location. Take special care to provide plenty of ventilation on all sides of the unit especially when it is placed in an audio rack. If ventilation is blocked, the unit may overheat and malfunction.
- Do not expose the unit to direct sunlight or heating units as the unit's internal temperature may rise and shorten the life of the pickup.
- Avoid damp and dusty places and places directly affected by vibrations from the speakers. In particular, avoid placing the unit on or above one of the speakers.
- Be sure the unit is placed in a horizontal position. Never place it on its side or on a slanted surface as it may malfunction.
- When you place the unit near a TV, radio, or VCR, the playback picture may become poor and the sound may be distorted. In this case, place the unit away from the TV, radio, or VCR.

## 7. Care

From time to time you should wipe the front and rear panels and the cabinet with a soft cloth. For heavier dirt, dampen a soft cloth in a weak solution of mild detergent and water, wring it out dry, and wipe off the dirt. Following this, dry immediately with a clean cloth.

Do not use rough material, thinners, alcohol or other chemical solvents or cloths since these could damage the finish or remove the panel lettering.

## 8. Notes on Handling

- When shipping the unit, use the original shipping carton and packing materials. For maximum protection, repack the unit as it was originally packed at the factory.
- Do not use volatile liquids, such as insect spray, near the unit. Do not leave rubber or plastic products in contact with the unit for a long time. They will leave marks on the finish.
- The top and rear panels of the unit **may become warm after a long period of use. This is not a malfunction.**
- When the unit is not in use, be sure to remove the disc and turn off the power.
- If you do not use the unit for a long period, the unit may not function properly in the future. Turn on and use the unit occasionally.

## 9. To Obtain a Clear Picture

The unit is a high technology, precision device. If the optical pick-up lens and disc drive parts are dirty or worn down, the picture quality becomes poor. To obtain a clear picture, we recommend regular inspection and maintenance (cleaning or parts replacement) every 1,000 hours of use depending on the operating environment. For details, contact your nearest dealer.

## 10. Notes on Moisture Condensation

**Moisture condensation damages the unit.**

**Please read the following carefully.**

### • What is moisture condensation?

Moisture condensation occurs, for example, when you pour a cold drink into a glass on a warm day. Drops of water form on the outside of the glass. In the same way, moisture may condense on the optical pick-up lens inside the unit, one of the most crucial internal parts of the unit.

### • Moisture condensation occurs in the following cases.

- When you bring the unit directly from a cold place to a warm place.
- When you use the unit in a room where you just turned on the heater, or a place where the cold wind from the air conditioner directly hits the unit.
- In summer, when you use the unit in a hot and humid place just after you move the unit from an air conditioned room.
- When you use the unit in a humid place.

### • Do not use the unit when moisture condensation may occur.





If you use the unit in such a situation, it may damage discs and internal parts. Remove the disc, connect the power cord of the unit to the wall outlet, turn on the unit, and leave it for two or three hours. After a few hours, the unit will have warmed up and evaporated any moisture. Keep the unit connected to the wall outlet and moisture condensation will seldom occur.

# Notes on Discs

This section shows you how to handle, clean, and store discs.

## Playable Discs

This DVD Player can playback the following discs.

	Disc mark		
DVD videos			
VIDEO CDs			
Audio CDs			

\*1 This unit can play CD-R and CD-RW discs recorded in CD Audio or Video CD format, or with MP3 audio files. However, playback may not be possible if the disc has not been finalized, if the disc recorder used a special format during recording, if the disc is a special format, if the disc damaged or dirty, or if there is condensation on the disc or player's pick up lens.

- You cannot playback discs other than those listed above.
- You cannot play discs such as CD-ROM, DVD-RAM, DVD-RW, etc., even if the marks in the above table are labeled on those discs.
- This DVD Player uses the PAL/NTSC color system, and cannot playback DVD videos recorded in any other color system (SECAM, etc.).
- Avoid using heart-shaped or octagonal discs. Playing irregularly shaped discs may damage the internal mechanism of the DVD Player.

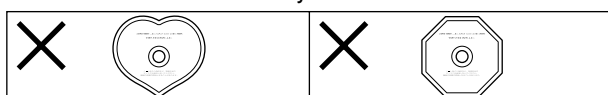

- Do not use discs that have residue from adhesive tape, rental discs that have peeling labels, or discs that have custom labels or stickers. Otherwise, you may not be able to eject the discs or the DVD Player may become inoperative.

## The Structure of the Disc Content

### DVD-Video

Normally, the contents of DVD-Video are divided into titles, and the titles are subdivided into chapters.

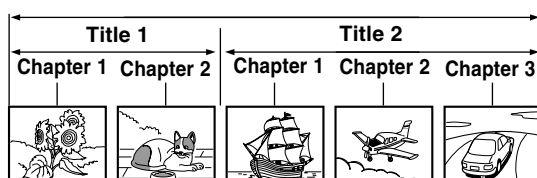

### Video CD/CD

Video CD and CD are divided into tracks.



## About VIDEO CDs

This DVD Player supports VIDEO CDs equipped with the PBC (Version 2.0) function. (PBC is the abbreviation of Playback Control.) You can enjoy two playback variations depending on the type of disc.

- VIDEO CD not equipped with PBC function (Version 1.1)**  
Sound and movies can be played on this DVD Player in the same way as an audio CD.
- VIDEO CD equipped with PBC function (Version 2.0)**  
In addition to operation of the VIDEO CD not equipped with the PBC function, you can enjoy playback with interactive software and search function using the menu displayed on the TV screen (Menu Playback). Some of the functions described in this Instruction Manual may not work with some discs.

## MP3 compatibility information

- The CD-ROM must be ISO 9660 compatible.
- Files should be MPEG1 Audio Layer 3 format, 44.1 or 48kHz, fixed bit-rate. Incompatible files will not play and "UNPLAYABLE MP3 FORMAT" will be displayed.
- Not compatible with variable bit-rate (VBR) files.
- This system only plays tracks that are named with the file extension ".mp3" or ".MP3".
- This system is not compatible with multi-session discs. If you try to play a multi-session disc, only the first session will be played.
- Use CD-R or CD-RW media for recording your MP3 files. The disc must be finalized in order to play.
- Audio encoded at 128Kbps should sound close to regular audio CD quality. Although this system will play lower bit-rate MP3 tracks, the sound quality becomes noticeably worse at lower bit-rates.
- Only the first 8 characters of folder and track names (excluding the ".mp3" extension) are displayed.
- This system can recognize a maximum of 250 folders and 250 tracks. Discs containing more than 250 folders or tracks will not play.

## Notes on Copyright

It is forbidden by law to copy, broadcast, show, broadcast on cable, play in public, and rent copyrighted material without permission.

DVD videos are copy protected, and any recordings made from these discs will be distorted.

This product incorporates copyright protection technology that is protected by method claims of certain U.S. patents and other intellectual property rights owned by Macrovision Corporation and other rights owners. Use of this copyright protection technology must be authorized by Macrovision Corporation, and is intended for home and other limited viewing uses only unless otherwise authorized by Macrovision Corporation. Reverse engineering or disassembly is prohibited.

# Notes on Discs

---

## Handling Discs

- Do not touch the playback side of the disc.

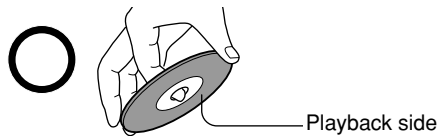

- Do not attach paper or tape to discs.



## Cleaning Discs

- Fingerprints and dust on the disc cause picture and sound deterioration. Wipe the disc from the center outwards with a soft cloth. Always keep the disc clean.

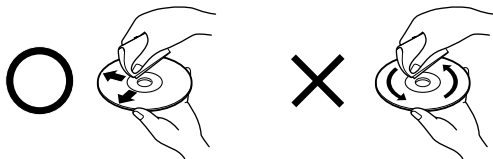

- If you cannot wipe off the dust with a soft cloth, wipe the disc lightly with a slightly moistened soft cloth and finish with a dry cloth.
- Do not use any type of solvent such as thinner, benzine, commercially available cleaners or antistatic spray for vinyl LPs. It may damage the disc.

## Storing Discs

- Do not store discs in a place subject to direct sunlight or near heat sources.
- Do not store discs in places subject to moisture and dust such as a bathroom or near a humidifier.
- Store discs vertically in a case. Stacking or placing objects on discs outside of their case may cause warping.

# Table of Contents

---

Important Safeguards/Precautions/Notes on Discs/Table of Contents .....	2-7
---	-----

## Getting Started

Features/Supplied Accessories .....	8
Preparing the Remote Controller .....	9
Index to Parts and Controls .....	10
Connecting to a TV .....	13
Connecting to an Amplifier (To Enjoy the Sound Advantage of the DVD Player) .....	14
Connecting the Power/Turning on the DVD Player .....	15
Setting Up the Player .....	16

## Basic Playback

Getting Started Using Your DVD Player .....	19
---	----

## Advanced Playback

Still Frame/Slow Play .....	23
Locating a Specific Title/Folder/Chapter/Track/Location .....	24
Repeat Play .....	26
Random Play .....	27
Playing in a Favorite Order .....	28
Selecting the Camera Angle .....	32
Selecting the Audio/Subtitle Language .....	33
Continuing Playback from a Specified Location (Last Memory) .....	34
Memorizing Settings for Often Viewed DVDs (Condition Memory) .....	35
Viewing Disc Information .....	36

## Function Setup

Adjusting Audio and Video Settings .....	38
--	----

## Others

Pre-programming remote controller .....	55
Troubleshooting .....	57
Specifications .....	59

# Features/Supplied Accessories

## Features

- Optical and Coaxial Digital Outputs for DTS\*1/Dolby\*2 Digital/PCM
- 192-kHz/24-bit Audio DAC
- Plays DVDs, MP3 CDs, CD-Rs, CD-RWs, Video CDs and Audio CDs
- 27-MHz/10-bit Video D/A conversion
- Audio file-Grade Audio Performance
- Composite Outputs/Component Video Output
- High Resolution On-Screen Display
- Powerful preprogrammed remote
- Direct Digital Path
- Heavy-duty power cord

\*1 "DTS" and "DTS Digital Out" are trademarks of Digital Theater Systems, Inc.

\*2 Manufactured under license from Dolby Laboratories.

"Dolby" and the double-D symbol  are trademarks of Dolby Laboratories.

## Supplied Accessories

Make sure your box contains everything listed below. The number of accessories is indicated in brackets.

Remote controller (RC-451DV) [1]  
Batteries (size AA/UM-3) [2]

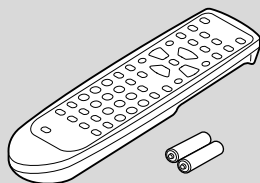

S-video cable [1]

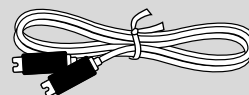

RI cable [1]

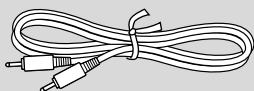

Audio/video connection cable [1]

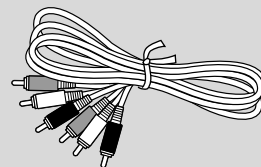

Power cord [1]

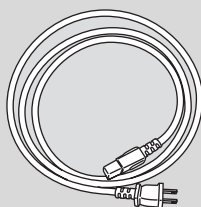

The alphabet displayed at the end of the product name found in catalogs and on the package represents the color of this player. Though the color varies, the specifications and operations are the same.



# Preparing the Remote Controller

## Inserting the Batteries

- ① Open the battery compartment cover.

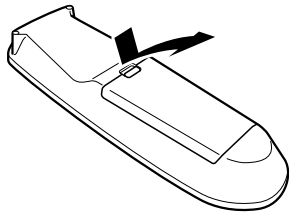

- ② Insert the two R6 (size AA) batteries. Be sure to match the + and - ends of the batteries with the diagram inside the battery compartment.

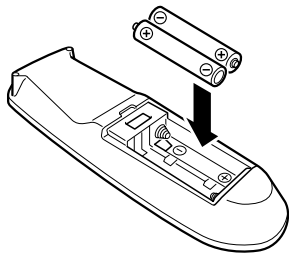

- ③ Close the battery compartment cover.

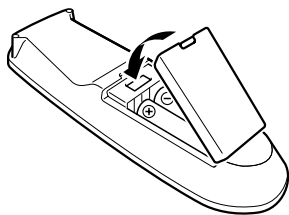

### Notes

- Do not mix new batteries with old batteries or different kinds of batteries.
- To avoid corrosion, remove the batteries if the remote controller is not to be used for a long time.
- Remove dead batteries immediately to avoid damage from corrosion. If the remote controller does not operate smoothly, replace both batteries at the same time.
- The life of the batteries supplied is about six months but this will vary depending on usage.

## Using the Remote Controller

Point the remote controller toward the remote control sensor.

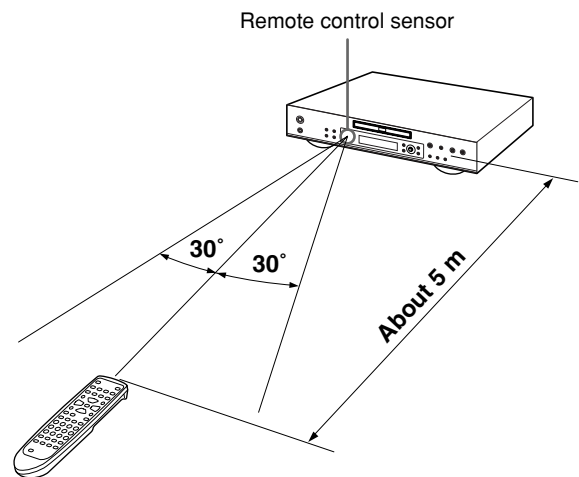

### Notes

- Place the unit away from strong light such as direct sunlight or inverted fluorescent light which can prevent proper operation of the remote controller.
- Using another remote controller of the same type in the same room or using the unit near equipment which uses infrared rays may cause operational interference.
- Do not put any object such as a book on the remote controller. The buttons of the remote controller may be pressed by mistake and drain the batteries.
- Make sure the audio rack doors do not have colored glass. Placing the unit behind such doors may prevent proper remote controller operation.
- If there is any obstacle between the remote controller and the remote control sensor, the remote controller will not operate.

# Index to Parts and Controls

For operational instructions, see the page indicated in brackets [ ].

## ■ Front panel

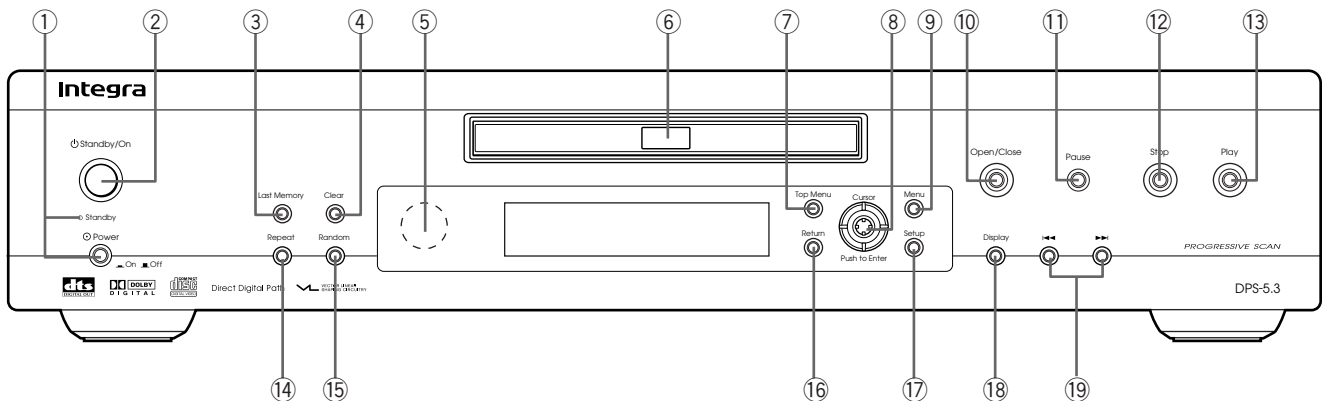

- ① **Power switch and Standby indicator [15]**

Turns on the main power supply for the DPS-5.3. The DPS-5.3 enters standby state and the Standby indicator lights up. Pressing the switch again to the off position (■Off) shuts down the main power supply into the DPS-5.3.

  - Before turning on the power, make sure all cables are properly connected.
- ② **Standby/On button [15, 16, 19, 22, 38, 54]**

When Standby/On button is pressed to On while the Power switch is set to On, the DPS-5.3 turns on and the Standby indicator turns off. Pressing the button again returns the DPS-5.3 to the standby state.
- ③ **Last Memory button [34]**

You can resume DVD or Video CD playback from the point you last watched even if the disc is removed from the player. Press Last Memory during playback to set a Last Memory point. When you want to resume playback of that disc, press Last Memory in the stop mode and playback starts from the memorized point. Last Memory locations can be stored for up to 5 DVDs and 1 Video CD.
- ④ **Clear button [25-30, 33-35, 49]**

Works in conjunction with a number of player functions. Use to cancel repeat and random playback, and to edit programs.
- ⑤ **Remote control sensor [9]**

Point the remote control toward the remote sensor to operate the player.
- ⑥ **Disc tray [19]**

When loading a disc, place discs in the disc tray with the label side facing up.
- ⑦ **Top Menu button [20, 24]**

Press to call up the top menu programmed on the DVD. Depending on the DVD, the top menu may be identical to the DVD menu.
- ⑧ **Cursor (◀/▶/▲/▼) button/Enter button [16, 19, 20, 25, 27-31, 37, 38, 44, 45, 49, 51, 52, 54]**

Use ◀/▶/▲/▼ to move through the options on menu screens and to change settings. Use Enter to implement settings selected with the cursor buttons or to set items highlighted in a menu.
- ⑨ **Menu button [20, 25, 32, 33, 48]**

Use to display or close the DVD menu or MP3 Navigator screen.
- ⑩ **Open/Close button [19, 22]**

Press to open and close the disc tray.
- ⑪ **Pause button [23]**

Press during playback to pause. Press again to resume playback.
- ⑫ **Stop button [16, 20, 22, 28, 30, 34]**

Press to stop playback. Pressing once enables playback to resume from a point shortly before the location where it stopped. Pressing twice causes the disc to return to the beginning of the disc if playback starts again.
- ⑬ **Play button [19, 21-24, 26-28, 30, 34]**

Press to start or resume playback.
- ⑭ **Repeat button [26]**

Use to set the repeat mode.
- ⑮ **Random button [27]**

Press to play chapters/tracks in random order.
- ⑯ **Return button [20, 38, 49, 52]**

Use to go one menu back (current settings are maintained). Use RETURN when you do not want to change the option setting in a menu.
- ⑰ **Setup button [16, 38, 39, 54]**

Press when the player is in either play or stop mode to open and close the Setup screen.
- ⑱ **Display button [36, 37, 45]**

Press during playback to display statistical disc information. Press repeatedly to display different information.
- ⑲ **◀◀/▶▶ button [20, 21]**

Press to go back or advance to previous chapters/tracks. Press and hold to perform fast-reverse/fast-forward playback scanning.

## ■ Display

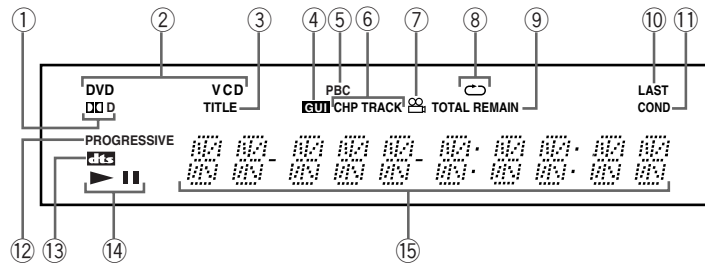

- |  |  |
|--|--|
| <ul style="list-style-type: none"> <li>① DVD indicator</li> <li>② Inserted disc indicator</li> <li>③ TITLE indicator</li> <li>④ GUI indicator<br/>Indicates an on-screen menu operation is being performed. On-screen menu helps you set up the player.</li> <li>⑤ PBC indicator</li> <li>⑥ CHP/TRACK indicator</li> <li>⑦ Angle icon indicator</li> </ul> | <ul style="list-style-type: none"> <li>⑧ REPEAT indicator</li> <li>⑨ TOTAL/REMAIN indicator</li> <li>⑩ LAST indicator</li> <li>⑪ COND indicator</li> <li>⑫ PROGRESSIVE indicator</li> <li>⑬ DTS indicator</li> <li>⑭ ►/   indicator</li> <li>⑮ Multifunctional indicator<br/>(e.g. operating status and error messages)</li> </ul> |
|--|--|

## ■ Rear panel

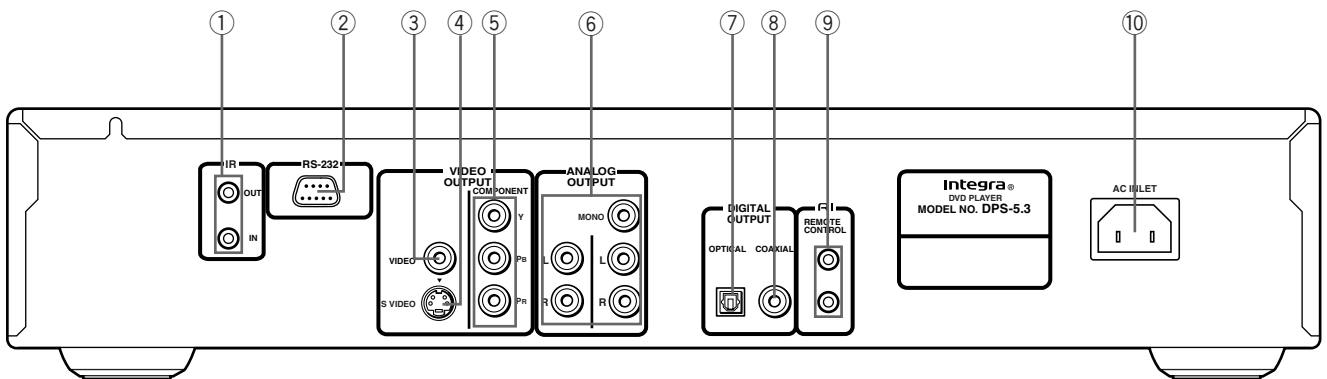

- |   |  |
|---|--|
| <ul style="list-style-type: none"> <li>① IR IN/OUT jacks [13]<br/>If the unit is located inside a rack or cabinet that will not allow infrared beams to reach the IR sensor, you will need to connect a remote sensor to IR IN input to be able to use the remote controller. Then install the remote sensor in an unblocked location where you can easily point the remote controller. Also use this jack to control other components with the included remote control.</li> <li>② RS-232 port<br/>This port is to be used in conjunction with an external controller to control the operation of the DPS-5.3 using an external device.</li> <li>③ VIDEO OUTPUT VIDEO jack [13]<br/>Connect to the video input on a TV or monitor or AV amplifier or receiver with video input capability.</li> <li>④ VIDEO OUTPUT S VIDEO jack [13]<br/>If your TV or monitor has an S video input, clear picture reproduction is possible by connecting the player to your TV or monitor via the S Video jack. You can switch between [S1] and [S2] S-video output from the Setup menu.</li> </ul> | <ul style="list-style-type: none"> <li>⑤ VIDEO OUTPUT COMPONENT jacks [13]<br/>If your TV or monitor has component video inputs, you can produce a higher quality picture on your TV or monitor by connecting to the component video outputs on this unit.</li> <li>⑥ ANALOG OUTPUT jacks [13, 14]<br/>Use to output two-channel audio (analog) to the audio stereo inputs on a TV or stereo amplifier. If you are connecting to a receiver that has both digital and analog input jacks for DVD player connection, it may be beneficial to make both connections.</li> <li>⑦ DIGITAL OUTPUT OPTICAL jack [14]<br/>Use to output the digital audio signal recorded on discs. You can output the digital signal via the optical output jack to an AV amplifier or receiver.</li> <li>⑧ DIGITAL OUTPUT COAXIAL jack [14]<br/>Use to output the digital audio signal recorded on discs. You can output the digital signal via the coaxial output jack to an AV amplifier or receiver.</li> <li>⑨ RI jack [14]<br/>Use to connect this player to another component bearing the RI mark. This lets you control this unit as though it were a component in a system.</li> <li>⑩ AC INLET [15]<br/>Use to connect the power cord to the wall outlet.</li> </ul> |
|---|--|

# Index to Parts and Controls

## ■ Remote controller

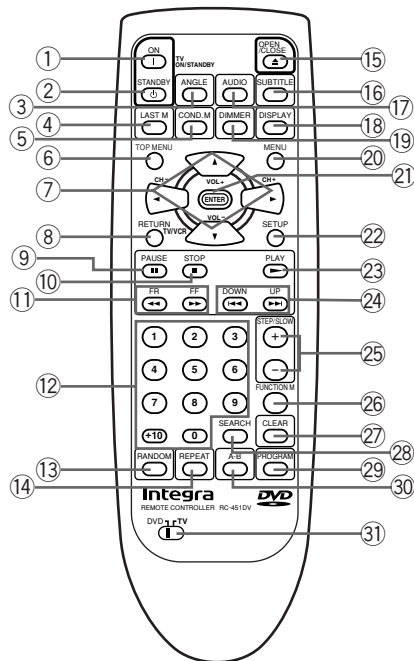

- ① **ON button** [15, 16, 19, 22, 38, 55]  
Press to switch the player on.
- ② **STANDBY button** [15, 22, 34, 55]  
Press to put the player in standby.
- ③ **ANGLE button** [32]  
Some DVDs are recorded with various camera angle playback options. Press ANGLE repeatedly to display different camera angles.
- ④ **LAST M button** [34]  
You can resume DVD or Video CD playback from the point you last watched even if the disc is removed from the player. Press LAST M during playback to set a Last Memory point. When you want to resume playback of that disc, press LAST M in the stop mode and playback starts from the memorized point. Last Memory locations can be stored for up to 5 DVDs and 1 Video CD.
- ⑤ **COND. M button** [35]  
You can store in memory the settings for up to 15 DVDs. Press COND. M during DVD playback to memorize the settings.
- ⑥ **TOP MENU button\*** [20, 24]  
Press to call up the top menu programmed on the DVD. Depending on the DVD, the top menu may be identical to the DVD menu.
- ⑦ **Cursor buttons (◀/▶/▲/▼)\*** [16, 19, 20, 25, 28-31, 37, 38]  
**VOL +/- buttons** [55]  
Use to move through the options on menu screens and to change settings.  
**CH +/-, VOL +/- buttons** [55]
- ⑧ **RETURN button\*** [20, 38, 49, 52]  
Use to go one menu back (current settings are maintained). Use RETURN when you do not want to change the option setting in a menu.  
**TV/VCR button** [55]
- ⑨ **PAUSE ■■ button** [23]  
Press to pause playback of a disc. Press again to resume playback.
- ⑩ **STOP ■ button** [16, 20, 22, 28, 30, 34]  
Press to stop playback. Pressing once enables playback to resume from a point shortly before the location where it was stopped. Pressing twice causes the disc to return to the beginning of the disc when playback starts again.

- ⑪ **FR/FF ◀◀/▶▶ buttons** [21]  
During playback of DVD and Video CD, press ▶▶ to perform fast forward scanning or ◀◀ to perform fast reverse scanning of DVD and Video CD. When a CD or MP3 is loaded, audio scanning is performed.
- ⑫ **Number buttons (1-9, 0, +10)\*** [19-21, 24-30, 49, 51, 52, 55]  
Use to perform direct title/folder and chapter/track searches, and to input numerical values.
- ⑬ **RANDOM button** [27]  
Press to play chapters/tracks in random order.
- ⑭ **REPEAT button** [26]  
Use to set the repeat mode.
- ⑮ **OPEN/CLOSE ▲ button** [19, 22]  
Press to open or close the disc tray.
- ⑯ **SUBTITLE button** [33, 48, 49]  
Press repeatedly to select one of the subtitle languages programmed on a DVD or to turn the subtitles off.
- ⑰ **AUDIO button** [33, 47]  
Press repeatedly to select one of the audio languages programmed on a DVD.  
For Video CD, CD and MP3, each press changes the audio output as follows.  
→ Stereo → 1L(Left) → 2/R(Right) →
- ⑱ **DISPLAY button** [36, 37, 45]  
Press during playback to display statistical disc information. Press repeatedly to display different information.
- ⑲ **DIMMER button** [37]  
Toggle to control the lightness of the display.
- ⑳ **MENU button\*** [20, 25, 32, 33, 48]  
Use to display or close the DVD menu or MP3 Navigator screen.
- ㉑ **ENTER button\*** [16, 19, 20, 25, 27-31, 38, 44, 45, 49, 51, 52, 54, 55]  
Use to implement settings selected with the cursor buttons or to set items highlighted in a menu.
- ㉒ **SETUP button\*** [16, 38, 39, 54]  
Press when the player is in either play or stop mode to open and close the Setup screen.
- ㉓ **PLAY ▶** [19, 21-24, 26-28, 30, 34]  
Press to start or resume playback.
- ㉔ **UP/DOWN ◀◀/▶▶** [20, 21]  
During playback, press ◀◀ to go back to a previous chapter/track and ▶▶ to advance to the next chapter/track .
- ㉕ **STEP/SLOW +/- buttons** [23]  
Press STEP/SLOW + or - during playback to view still frame. Press and hold STEP/SLOW + or - during playback to view slow playback. In still frame, press STEP/SLOW + to advance DVDs and Video CDs frame by frame and STEP/SLOW - to back up a few frames at a time (DVD only).
- ㉖ **FUNCTION M button** [54]  
You can store in memory up to 5 settings. Press FUNCTION M to memorize and recall the settings.
- ㉗ **CLEAR button** [25-30, 33-35, 49]  
Works in conjunction with a number of player functions. Use to cancel repeat and random playback, and to edit programs.
- ㉘ **SEARCH button** [24]  
Press to perform a title/folder, chapter/track or elapsed time search.
- ㉙ **PROGRAM button** [25, 28-31]  
You can program titles, chapters, or tracks to play back in a desired order. Programs can be a maximum of 24 steps. Additionally, DVD programs for up to 24 discs can be stored in the player's memory for future use.
- ㉚ **A-B button** [26]  
Press at the beginning and end of the section you want to repeat or to mark a location you want to return to.
- ㉛ **DVD/TV switch** [55]

(Buttons indicated with \* are used for menu operation.)  
Download from [Www.Somanuals.com](http://www.Somanuals.com). All Manuals Search And Download.

# Connecting to a TV

## Before connecting

- Refer also to the instruction manual of the TV.
- When you connect the DVD Player to the TV, be sure to turn off the power and unplug both units from the mains before making any connections.
- Connect the DVD Player to the TV directly. If you connect the DVD Player to a VCR, TV/VCR combination, or video selector, the playback picture may be distorted as DVD videos are copy protected.

- Connect the plugs securely.

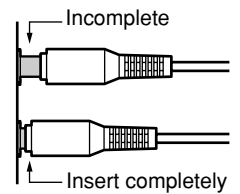

## ■ Making component video connections

If the TV or monitor has component video inputs, making this type of video connection will produce the ideal picture quality for the presentation of DVD-Video. Using a component video cable (sold separately), connect the VIDEO OUTPUT COMPONENT jacks to the corresponding component video input jacks on the TV.

Actual labels for component video inputs may vary depending on the TV manufacturer. (e.g. Y, R-Y, B-Y or Y, CB, CR)

In some TVs or monitors, the color levels of the playback picture may be reduced slightly or the tint may change. In such a case, adjust the TV or monitor for optimum performance.

**BE sure to set the TV Aspect after connection using the Setup Navigator explained in "Setting Up the Player" starting on page 16 or the function setting menu explained in "Adjusting Audio and Video Settings" starting on page 38.**

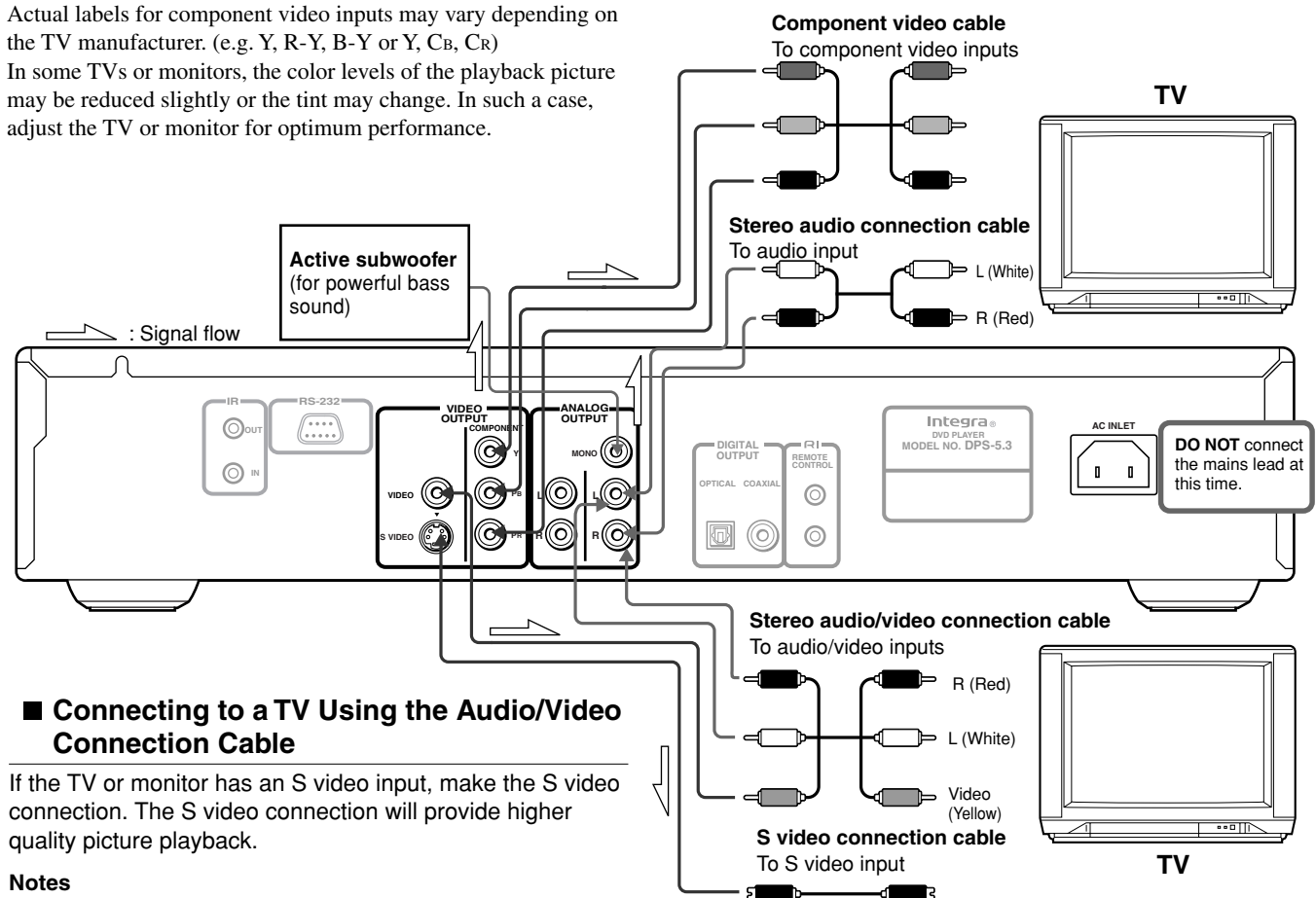

## ■ Connecting to a TV Using the Audio/Video Connection Cable

If the TV or monitor has an S video input, make the S video connection. The S video connection will provide higher quality picture playback.

### Notes

- If you make the S video connection, leave the yellow plug disconnected.
- If the TV audio is monaural, leave the red plug disconnected.

## ■ IR IN/OUT jacks

The following equipment (sold separately) is essential for operation:

- Onkyo's Multi-Room System kits (IR Remote Controller Extension System), or
- Multiroom A/V distribution and control systems from Niles® and Xantech® to name a few.
- Xantech is a registered trademark of Xantech Corporation.
- Niles is a registered trademark of Niles Audio Corporation.

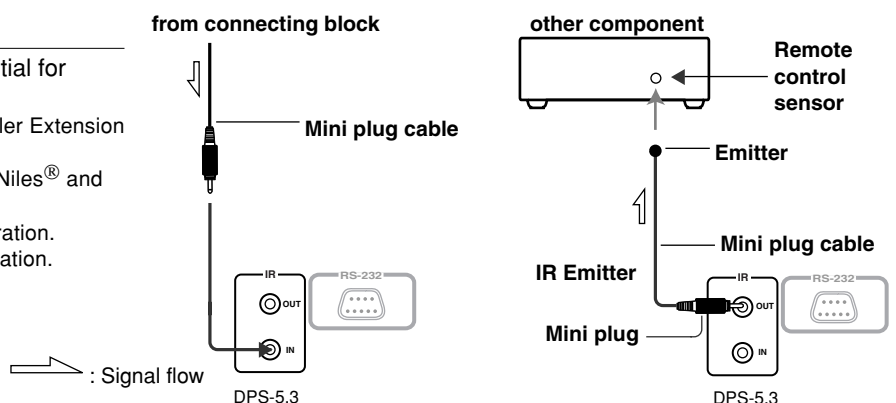

# Connecting to an Amplifier (To Enjoy the Sound Advantage of the DVD Player)

Although you can reproduce the DVD Player's sound from the TV speakers with the connections on the opposite page, connecting with an amplifier provides you high quality dynamic sounds.

To reproduce Dolby Digital surround, MPEG1 audio, MPEG2 audio, and DTS surround sound, you need to connect to an amplifier with a Dolby Digital, MPEG1 audio, MPEG2 audio, and DTS decoder respectively.

## Before connecting

- Refer to the instruction manual of the amplifier.
- When you connect the DVD Player to the amplifier, be sure to turn off the power and unplug both units from the mains before making any connections. Otherwise, the speakers may be damaged.
- Connect the plugs securely.

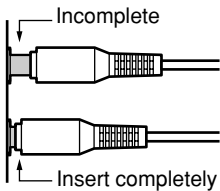

## Notes

- The remote controller supplied with Onkyo amplifier can be used to operate the DVD player.
- The function of the upper and lower **RI** connectors are the same. Connect to either one.
- Connecting **RI** cable only does not make the system operational. You must also connect the audio cables as well.
- For remote control operation, the audio connection cables must also be connected.

## ■ Making a digital connection with the amplifier

If your amplifier has a digital input jack, be sure to connect it to either DIGITAL OUTPUT OPTICAL or COAXIAL jack on the DVD player.

### Notes

DO NOT connect to the AC-3RF input (e.g. of a Dolby Digital receiver) which is reserved only for video disc players.

**BE sure to set the digital output setting after connection using the Setup Navigator explained in "Setting Up the Player" starting on page 16 or the function setting menu explained in "Adjusting Audio and Video Settings" starting on page 38.**

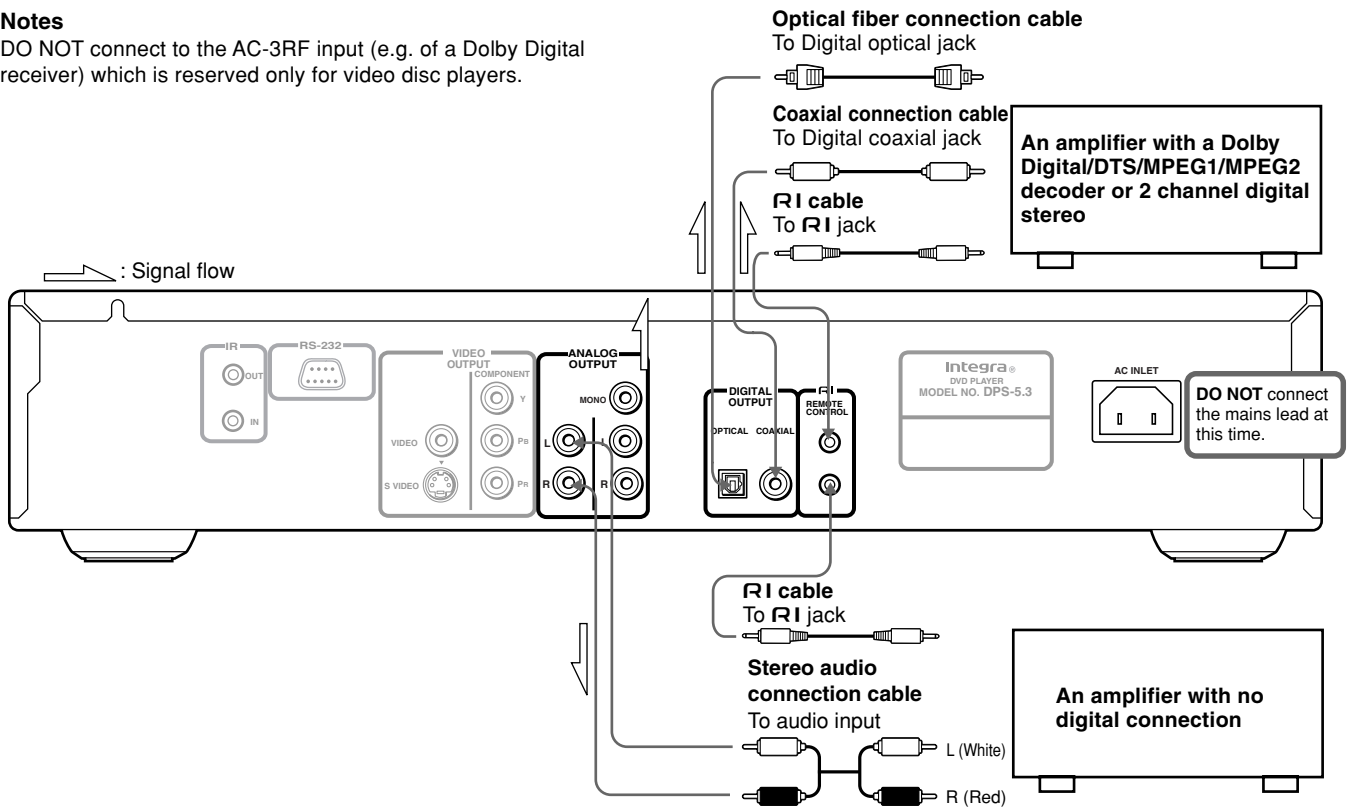

## ■ Making the analog connection with the amplifier

If your amplifier has no digital audio input, you can make the analog connection. If the amplifier has a Dolby Pro Logic decoder, you can reproduce the Dolby Pro Logic surround sound.



# Connecting the Power/ Turning on the DVD Player

## Before connecting

- The DPS-5.3 is shipped with the main power (Power) switch in the on position (⏻On). When the power cord is plugged in for the first time, the DPS-5.3 will automatically enter the standby state and the Standby indicator will light (same condition after step 2 below).
- Make sure that all the connections on pages 13 and 14 are complete (the connection to a TV is required).

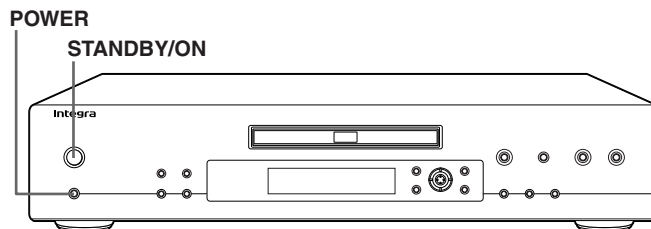

# 1

## Plug the supplied power cord into the AC INLET and then into the power outlet on the wall.

- Do not use a power cord other than the one supplied with the DPS-5.3. The power cord supplied is designed for use with the DPS-5.3 and should not be used with any other device.
- Never have the power cord disconnected from the DPS-5.3 while the other end is plugged into the wall outlet. Doing so may cause an electric shock. Always connect by plugging into the wall outlet last and disconnect by unplugging from the wall outlet first.

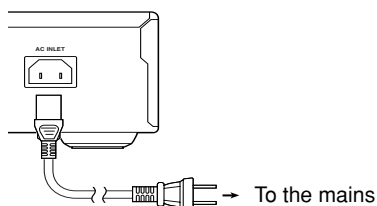

# 2

⏻ Power



## Press Power to switch on the main power.

The DVD Player enters standby mode.  
The Standby indicator lights up.

- The buttons on the remote controller do not operate if the Power switch is set to Off.
- To switch off the main power, press Power again.

# 3

⏻ Standby/On



## Press Standby/On on the DVD Player or ON on the remote controller.

The DVD Player turns on and the Standby indicator turns off.

- To put the DVD Player in the standby mode, press Standby/On on the DVD Player, or STANDBY on the remote controller. Be sure to set the volume to minimum before putting the DVD Player in the standby mode for the next use to avoid sudden loud sound reproduction.
- While the Standby indicator lights up, the DVD Player can receive signals from the remote controller. However, if you press Power on the DVD Player to switch off the main power, the remote controller cannot be used to turn on the DVD Player.
- Setting the STANDBY button to standby does not shut off the power completely.

# Setting Up the Player

The Setup Navigator has been designed to simplify the process of getting the DVD player ready to perform. Designed as a series of on-screen multiple-choice questions, the Setup Navigator automatically sets the audio, video, and language settings according to how the questions are answered. Once this procedure is complete, it will be possible to begin using the DVD player to enjoy DVDs.

The procedure on this page describes the operations necessary to function within the Setup Navigator screens. A detailed description of the contents of each question that appears on the screen can be found on the following pages.

## Using the Setup Navigator



**1 Press ON (Standby/On on the front panel).**

If there's already a disc loaded and it starts to play, press ■ to stop it.



**2 Press SETUP.**

When SETUP is pressed for the first time, the following screen appears. Though the Setup Navigator may be used more than once, this screen only appears the first time SETUP is pressed.

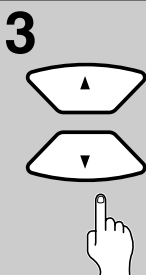
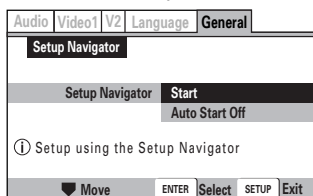

**3 Use the cursor buttons (▲/▼) to make a selection.**

- If you are going to use the Setup Navigator, it is not necessary to change the setting on the first screen. Please proceed to the next step.
- If you do not want to set up the player using the Setup Navigator, use the cursor button (▼) to select [Auto Start Off] at this time.  
The Setup Navigator function may still be used at a later time in manual Setup screen menu operation (page 38).



**4 Press ENTER.**

The selection is entered and the next Setup Navigator screen appears.

Use steps 3 and 4 as a basis for entering selections on the all of the Setup Navigator screens described on the following pages.

### ■ When setting up for the first time

Some DVDs start playing automatically when loaded in the player. Because the Setup Navigator cannot be used if a disc is playing, it is recommended to set up the player using the Setup Navigator before loading a DVD for the first time. If a DVD has been loaded, be sure to press ■ before proceeding.

### ■ To change the answer to a prior question

Use the cursor button (◀) to return to previous screens. Please note, however, that you cannot go forward using the cursor button (▶), so it will be necessary to answer all the questions that occur after the screen that was returned to.

### ■ To exit the Setup Navigator

Press SETUP while on any of the screens to exit the Setup Navigator. Please note that if the Setup Navigator is exited before all the questions are answered, no settings are changed.

#### Note

On-screen information (ⓘ) appears to clarify the functions and explain the options available.



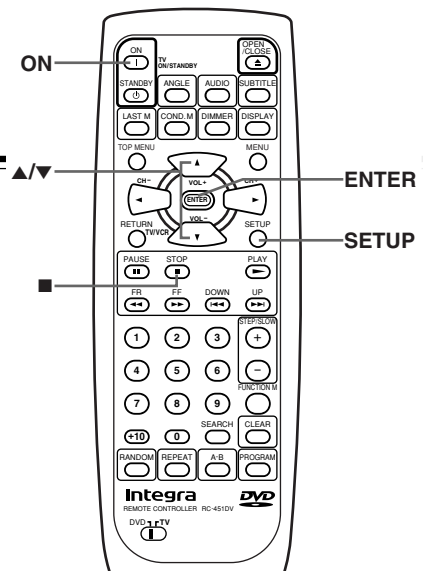

### ■ Setting the OSD Language (On-Screen Display Language)

The [OSD Language] screen establishes the OSD language, or on-screen display language, which refers to the language that is used by the player in menus and on-screen messages. Additionally, the language that is established at this setting will also be used for the default audio and subtitle language.

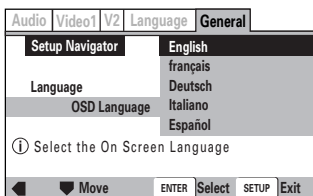

Settings: **English** (Factory setting)  
**français**  
**Deutsch**  
**Italiano**  
**Español**

#### Notes

- The languages that can be selected may be different from those shown above.
- In addition to setting the [OSD Language], the audio and subtitle language are also set at this time. If you wish to change the audio or subtitle language to a different language, make changes in the Setup screen Language menu [Audio Language] and [Subtitle Language] as needed (pages 47, 48).

### ■ Setting the TV screen size

The [TV Type] screen establishes the size, or more appropriately the width to height ration of your television or monitor. The width-to-height ratio of conventional TVs is 4:3, while the width-to-height ratio of wide screen and high-definition TVs is 16:9. This width-to-height ratio is called the aspect ratio.

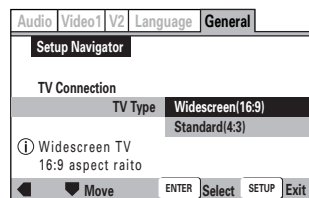

Settings: **Widescreen (16:9)** (Factory setting)  
**Standard (4:3)**

#### Note

There are two screen formats that can be used to display wide-screen format DVDs: letter box and pan & scan. When [Standard (4:3)] is selected in the Setup Navigator, the letter box screen format is automatically selected. To switch the preference to the pan & scan format, make changes in the Setup screen Video 1 menu [TV Screen] setting (page 42).

# Setting Up the Player

## Using the Setup Navigator

### ■ Setting digital audio connections to an AV amplifier or decoder

The [Digital Jack] screen establishes whether digital connections have been made to an AV amplifier, receiver, or external decoder. As there are numerous options available, please refer to the instructions supplied with the component the player is connected to determine what digital audio formats can be decoded. If you have made no digital connections, select [Not Connected].

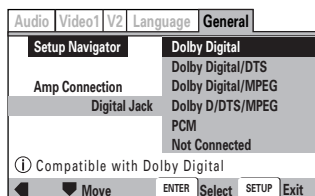

Settings: **Dolby Digital** (Factory setting)  
**Dolby Digital/DTS**  
**Dolby Digital/MPEG**  
**Dolby D/DTS/MPEG**  
**PCM**  
**Not Connected**

#### Warning

- Do not set [Digital Jack] to [Dolby Digital/DTS] or [Dolby D/DTS/MPEG] if the amplifier does not have a DTS decoder. If you do so, high volume sound may be output and damage your hearing as well as speakers.
- Select [PCM] when you connect the player to a 2 channel digital stereo amplifier. If you select other than [PCM], high volume sound may be output and damage your hearing as well as speakers.

### ■ Setting compatibility with 96 kHz output

The [96 kHz PCM Audio] screen establishes whether or not the AV component the player is connected to is capable of processing an audio signal with a sampling rate of 96 kHz. This screen only appears if connections have been made to an external AV component as determined in previous screens.

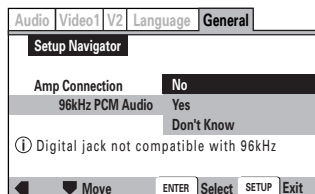

Settings: **No** (Factory setting)  
Select if the connected AV component cannot process an audio signal with a sampling rate of 96 kHz.

**Yes**  
Select if the connected AV component can process an audio signal with a sampling rate of 96 kHz.

**Don't Know**  
Select if you are uncertain whether the connected AV component can process an audio signal with a sampling rate of 96 kHz.

### ■ Confirming the settings

The [Exit Setup Navigator] is the final screen in the Setup Navigator.

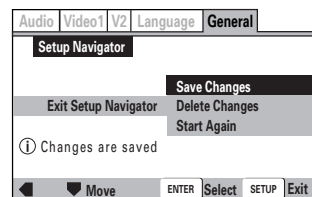

Settings: **Save Changes** (Factory setting)  
Select to have the player make all of the necessary audio, video and language settings according to your responses in the Setup Navigator.

#### Delete Changes

Select to exit the Setup Navigator without changing any of the system settings.

#### Start Again

Select to return to the [OSD Language] screen of the Setup Navigator and do the settings again.

### ■ To change other player settings in the Setup screen menus

The procedure for changing the settings in the Setup screen menus is described on page 38.

# Getting Started Using Your DVD Player

Before you can start to enjoy the digital audio and video on DVDs, be sure that you have either performed the Setup Navigator procedure described in the previous section or made the necessary settings in the Setup screen menus as outlined in the next section to set up the player to correspond to your home system. Having made these settings, you are now ready to start using the player to enjoy DVDs, Video CDs, CDs and MP3s.

## Warning

If the DVD Player is connected to the TV or amplifier through the analog audio jacks, do not play DTS-encoded discs. Excessive noise may be output from the analog stereo jacks, which may damage the connected equipment. To reproduce DTS surround sounds, digital connection to an amplifier with a DTS decoder is needed.

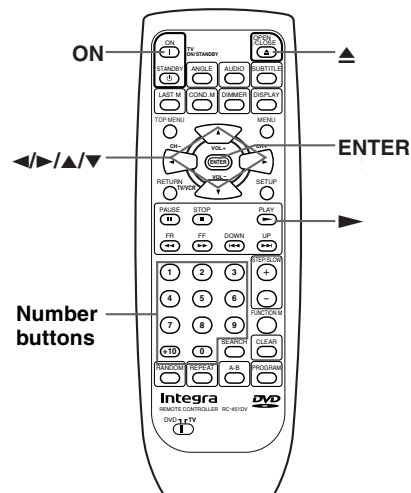

DVD VCD CD MP3

## Playing DVDs, Video CDs, CDs and MP3s

<b>1</b>		<b>Press ON (Standby/On on the front panel).</b>
<b>2</b>		<b>Press ▲.</b> The disc tray comes out.
<b>3</b>		<b>Load a disc.</b> Load a disc with the label side facing up, using the disc tray guide to align the disc.
<b>4</b>		<b>Press ►.</b> <ul style="list-style-type: none"> <li>The disc tray closes, and playback begins.</li> <li>MP3 only: It may take a few seconds for the player to locate the track on the disc, depending on the complexity of the file structure. During this time, "Please wait a moment" is displayed.</li> <li>Depending on the disc, a menu may be displayed. If a menu is displayed, proceed to step 5.</li> </ul>

<b>5</b>		<b>Select the item you want to view.</b>
		<ul style="list-style-type: none"> <li>When a DVD is loaded: Select the item with the cursor buttons (◀/▶/▲/▼) or the number buttons then press ENTER.</li> <li>When a Video CD is loaded: Use the number buttons to select the item.</li> </ul>

## Notes

- Noise is output if you make digital audio connections to a receiver or amplifier that does not have a built-in decoder. Check that the digital audio output format selected in the Audio menu corresponds to the audio components you have made connections to (pages 18, 40, 41).
- The TV screen size is factory set to present the wide screen format (16:9 aspect ratio). If you have a standard TV screen (4:3 aspect ratio), this setting can be changed to match your TV screen size in the Video 1 menu (pages 17, 42).
- Do not move the DVD Player during playback. Doing so may damage the disc.
- Use ▲ on the remote controller or Open/Close on the DVD Player to open and close the disc tray. Do not touch the disc tray while it is moving. Doing so may cause the DVD Player to malfunction.
- Do not press down on the disc tray or put any objects other than playable discs on the disc tray. Doing so may cause the DVD Player to malfunction.
- In many instances, a menu screen appears when playback of a movie is complete. Prolonged display of an on-screen menu may damage your television set, permanently etching that image onto its screen. To avoid this, be sure to press ■ once the movie is complete.

## ■ When an operation is prohibited

There are times when you are using the player and attempt to perform an operation, but for some reason it cannot be performed. When this occurs, one of the two following icons appears on the screen.

- The operation is prohibited by the player.
- The operation is prohibited by the programming on the disc.

## ■ About the DVD, VCD, CD and MP3 marks in the pages related to disc operation

- DVD means the function or title is related to DVD-Video operation.
- VCD means the function or title is related to Video CD operation.
- CD means the function or title is related to audio CD operation.
- MP3 means the function or title is related to MP3 operation.

# Getting Started Using Your DVD Player

DVD VCD

## When a Menu Screen is Displayed

Menu screens are displayed for DVDs that have menu screens or Video CDs that include Playback Control (PBC). DVDs often contain extra information that can be accessed in the DVD menu and sometimes makes navigating DVD menu screens as enjoyable as watching the feature presentation.

Example: When a DVD that has menu screens is loaded



Example: When a Video CD that has Playback Control is loaded



## ■ To navigate a menu screen

- Although individual DVD titles may differ, when a menu screen is displayed, use the cursor buttons (◀/▶/▲/▼) and ENTER on the remote control. The cursor buttons are used to move around the options on the screen and ENTER is used for selection.
- Occasionally, the number buttons may also be used to make selections. If this is possible, using number buttons serves to directly select an option on a menu screen. Only number buttons are used to make selections on Video CD menu screens.
- When the Video CD has more than one menu, pages can be advanced to or returned to with ◀◀ or ▶▶.

DVD VCD

## To Open or Return To the DVD or Video CD Menu Screen

Although this differs depending on the disc, pressing MENU, TOP MENU, or RETURN during DVD playback or RETURN during Video CD playback displays the menu screen. Refer to the DVD or Video CD disc jacket and accompanying documentation for more information.

## ■ To play Video CDs without displaying menu screens

Video CDs with Playback Control (PBC) display a menu screen when play is started. It is possible, however, to play back Video CDs without displaying menu screens. When a Video CD with PBC is loaded, press ■, and then the number button of the track you want to play.

## MP3 Compatibility Information

- The CD-ROM must be ISO 9660 compatible.
- Files should be MPEG1 Audio Layer 3 format, 44.1 or 48kHz, fixed bit-rate. Incompatible files will not play and "UNPLAYABLE MP3 FORMAT" will be displayed.
- Not compatible with variable bit-rate (VBR) files.
- This system only plays tracks that are named with the file extension ".mp3" or ".MP3".
- This system is not compatible with multi-session discs. If you try to play a multi-session disc, only the first session will be played.
- Use CD-R or CD-RW media for recording your MP3 files. The disc must be finalized in order to play.
- Audio encoded at 128Kbps should sound close to regular audio CD quality. Although this system will play lower bit-rate MP3 tracks, the sound quality becomes noticeably worse at lower bit-rates.
- Only the first 8 characters of folder and track names (excluding the ".mp3" extension) are displayed.
- This system can recognize a maximum of 250 folders and 250 tracks. Discs containing more than 250 folders or tracks will not play.

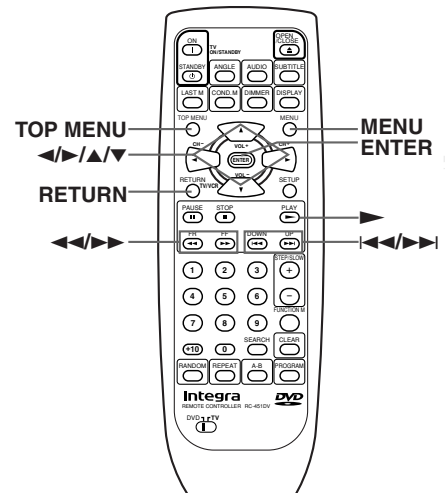

DVD VCD CD MP3

## Chapter (Track) Skip Forward/Skip Back



### Advancing to the next chapter (track)

**Press** ►►.

Press to skip forward to the next chapter (track).



### Skipping back to the previous chapter (track)

**Press** ◄◄.

- Press once to skip back to the start of the chapter (track) currently playing.
- Press twice to skip back to the start of the previous chapter (track).

DVD VCD CD MP3

## Forward and Reverse Scanning

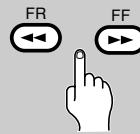

### Fast forward and reverse scanning

**Press and hold** ►► or ◄◄ during playback to scan forwards or backwards.

While “►► 1” or “◄◄ 1” is displayed on-screen blinking, release the button to resume normal playback.

### Variable speed scanning

**1 Press (but don't hold)** ►► or ◄◄ during playback to start scanning.

“►► 1” or “◄◄ 1” appears on screen.

**2 Depending on the type of disc playing, you can increase the scanning speed by pressing** ►► or ◄◄.

The scan speed is shown on-screen.

DVD discs have three scanning speeds; 1, 2 and 3.

CD and Video CDs have two scanning speeds;

1 and 2.

MP3 have only one scanning speed.

**3 Press** ► to resume normal playback.

# Getting Started Using Your DVD Player

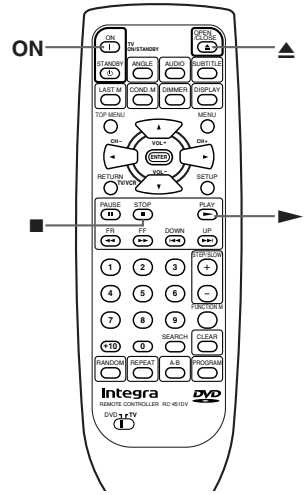

DVD VCD

## Resuming playback from where you stopped

Use the resume feature to restart playback from the point that the disc was stopped last time. This features cannot be used with MP3s and CDs.



**Press ■ once.**

The display shows "RESUME" and the stop position is memorized.

- The resume position remains memorized as long as the disc is in the player — even if you switch the power off.
- Pressing ■ twice causes the disc to return to the beginning when ► is pressed again. The display shows the disc type (DVDs or Video CDs).



**Press ►.**

Playback starts from the resume position.

### Notes

- The actual restart position may be slightly before or after the resume position.
- If you want to remove the disc, but still want to resume playback from the last stopped position, use the LAST MEMORY feature instead (page 34).
- The memorized resume position is erased when you open the disc tray, or change the Parental Lock Level setting (page 51) or On-screen Display (OSD) setting (page 47).

DVD VCD CD MP3

## Stopping Playback and Switching Power Off

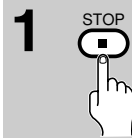

**Press ■.**

Playback stops.



**Press ▲.**

The disc tray comes out.

**3**

**Remove the disc.**

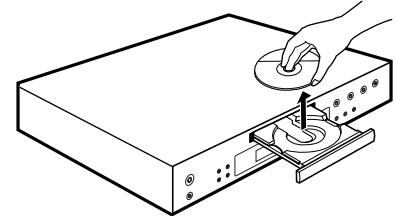

**Press STANDBY (Standby/On on the front panel).**

The disc tray goes back in.

# Still Frame/Slow Play

The video images on DVD and Video CD can be viewed as a still frame, played back at slow speeds and even advanced frame by frame.

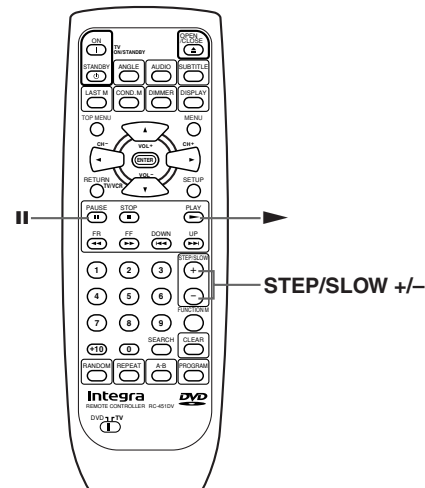

DVD VCD

## Viewing a still frame

**Press ||, STEP/SLOW +/-.**

When viewing a DVD, if the paused picture shakes, select the [Field] setting in the Setup screen Video 1 menu [Still Picture] setting as described in the section on page 46.

### ■ Frame by frame advance playback: Viewing one frame at a time

You can't use frame review with Video CDs.

- 1 Press ||, STEP/SLOW +/-.
- 2 Press STEP/SLOW +/-.  
STEP/SLOW +: The picture advances one frame each time the button is pressed.  
STEP/SLOW -: The picture backs up a DVD a few frames each time the button is pressed.

### ■ To return to normal playback

When viewing a still frame playback, pressing || or ► restores normal playback operation.

#### Notes

- There is no sound when viewing still frames or slow playback, or when advancing one frame at a time.
- Still frame, slow play, or frame advance playback may not be possible with certain titles. In this case, the mark is displayed.

DVD VCD

## Viewing slow playback

You can't use slow reverse play with Video CDs.

- 1 **STEP/SLOW**  
+  
-  
During still frame playback, press and hold STEP/SLOW +/- during playback.
- 2 **STEP/SLOW**  
+  
-  
Press STEP/SLOW +/- repeatedly to change the slow-motion speed.  
There are four forward slow-motion play speeds:  
  
There are two reverse slow-motion play speeds:  
Slow 1 ↔ Slow 2

### ■ To return to normal playback

When viewing a slow playback, pressing ► restores normal playback operation.

# Locating a Specific Title/Folder/Chapter/Track/Location

DVD VCD CD MP3

## Searching for a Title, Folder, Chapter, Track, or Location on a Disc

This player offers different ways of accessing the information on a DVD, Video CD, CD or MP3. Using SEARCH, you can search for titles or chapters on a DVD, tracks on a Video CD, CD or folders or tracks on a MP3 and even select the point in time to start playback.

### Notes

- For some discs, selection can be made using the top menu on the DVD. In this case, press TOP MENU to display the menu screen and then make your selection.
- With some DVDs, the search operation may not be possible and may stop shortly after being performed. In this case, the  mark is displayed.
- Time search is not possible with CDs and MP3s.
- When performing DVD or Video CD time search, playback may start from a slightly different time than that specified.
- Time search is not possible during when the disc is stopped.
- Search using time search is not possible during PBC playback of Video CDs.



**Press SEARCH repeatedly to select the type of search.**

The type of search changes which each press as follows.

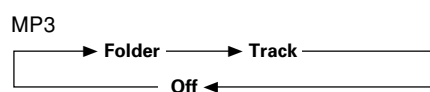
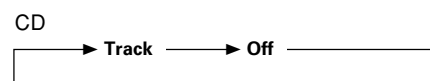
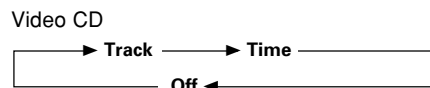
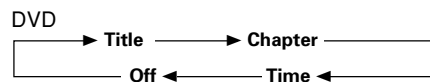

### ■ To perform a direct title or chapter/track search using the number buttons

- Press the number buttons while the disc is stopped to select a title or track number.
- Press the number buttons while the disc is playing to select a chapter or track number.
  - To select number 3, press 3.
  - To select number 10, press 1 and 0.
  - To select number 37, press +10, +10, +10 and 7.

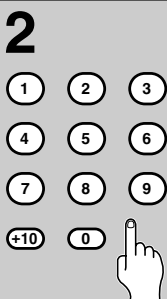

**Press the number button(s) of the desired title, chapter or track or of the specific time where you would like to begin playback.**

- To select number 3, press 3.
- To select number 10, press 1 and 0.
- To select number 87, press 8 and 7.

**When performing a time search:**

- To select 21 minutes, 43 seconds, press 2, 1, 4, and 3.
- To select 1 hour, 14 minutes, press 7, 4, 0, and 0.



**Press ►.**

Playback of the selected title, folder, chapter or track starts. When a time search is performed, playback begins at the appointed time.



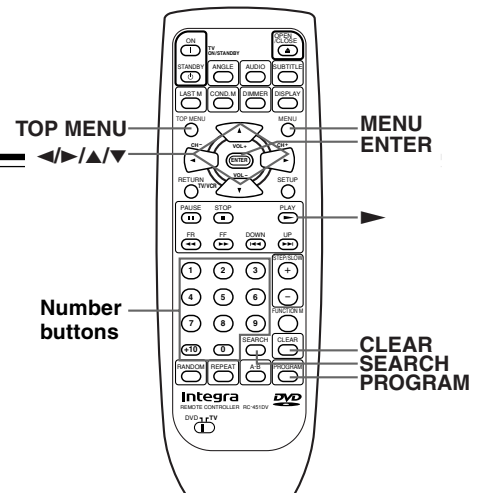

MP3

## Using the MP3 Navigator

Use the MP3 Navigator to make searching for the track(s) you want to play easier. You can also use it to add or clear tracks from the program list.

1

**Load a CD-ROM containing MP3 tracks.**

2



**Press MENU to enter the MP3 Navigator screen.**

The left side of the screen shows a list of folders containing MP3 tracks.

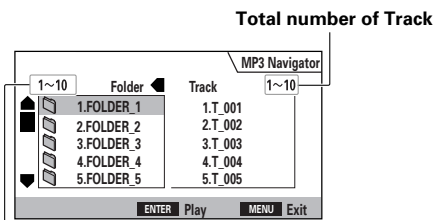

**Total number of Folder**

If you display the MP3 Navigator when a disc is playing, the currently playing folder and track numbers are shown at the top left of the screen.

On the right side is a list of MP3 tracks from the first title in the list.

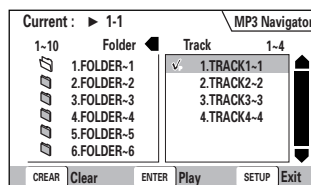

### ■ Navigate using the following controls:

- Cursor buttons (◀▶) Select folder and tracks from the current screen.
- Cursor buttons (▲▼) Select the previous/next of folders and tracks. To move rapidly up or down a long list of folders or tracks, press and hold the Cursor buttons (▲▼).
- ENTER Play the currently selected folder or track. MP3 tracks that are unplayable on this system are automatically skipped and the display shows "UNPLAYABLE MP3 FORMAT".
- MENU Exit the MP3 Navigator
- PROGRAM Add the currently selected track to the program list. (Tracks in the program list are marked ✓.) Pressing PROGRAM repeatedly will add the track to the program list repeatedly.
- CLEAR Clear the currently selected track from the program list.

# Repeat Play

You can repeat an entire title, folder, chapter or track, or just a part.

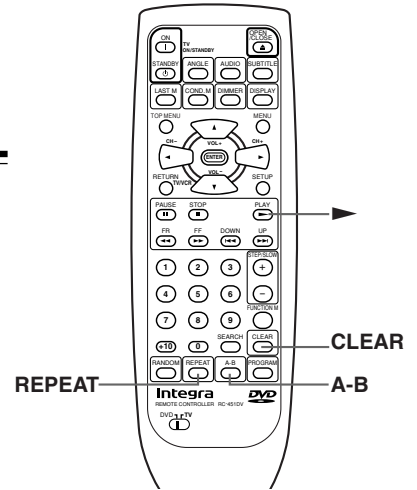

DVD VCD CD MP3

## Repeating a Title, Folder, Chapter or Track

REPEAT



### Repeat play of a chapter/track

Press REPEAT once during playback of the chapter or track you want to repeat.

### Repeat play of a title/folder

Press REPEAT twice during playback of the title you want to repeat.

### Repeat play of a disc

VCD CD

Press REPEAT twice during playback of the disc you want to repeat.

MP3

Press REPEAT three times during playback of the disc you want to repeat.

### ■ To repeat a program

Press REPEAT once during program playback to repeat the program.

### ■ To cancel repeat play

Press CLEAR. Playback continues, but the repeat function is canceled.

DVD VCD CD

## Repeating a Specific Segment



### Repeat play of a specified section

Press A-B at the beginning and end of the section you want to repeat.

- When A-B is pressed a second time, the disc returns to the location where A-B was pressed first and plays the selected section repeatedly.
- You can only perform A-B repeat within the same title, chapter, or track.

### Return to a specified location on a disc

- 1 Press A-B at the desired location.
- 2 When you want to return to the specified location, press ►.

### ■ To cancel A-B repeat play

Press CLEAR. Playback continues, but the repeat function is canceled.

### ■ To clear the specified location

Press CLEAR to cancel repeat play or to clear the specified location that was set using A-B.

### Notes

- With some DVD discs, there may be times when repeat playback is not possible. In these cases, the  mark will appear on the screen.
- With Video CDs, repeat play is not possible when the menu is displayed (PBC playback). To perform repeat play, start playback without displaying a menu by pressing the track number to be repeated when the disc is stopped, and then press REPEAT.
- You cannot use A-B repeat when listening to an MP3.
- If you switch camera angle during repeat play, repeat play is cancelled.

# Random Play

Play titles, chapters, or tracks on a disc in random order.

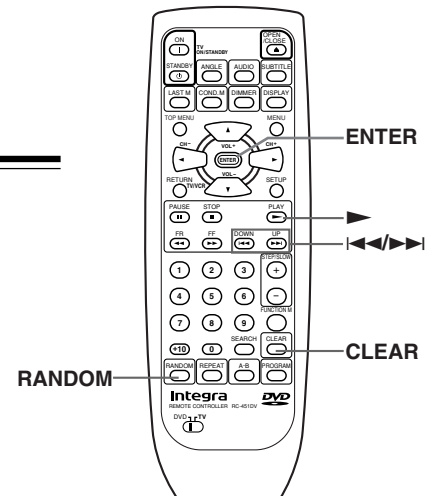

DVD VCD CD MP3

## Playing in Random Order

RANDOM



### Random playback of chapters within one title

Press **RANDOM** once, then press **ENTER** or **▶**.

"Random Chapter" appears on the screen, and chapters within the title will be played back in random order.

### Random playback of titles

Press **RANDOM** twice, then press **ENTER** or **▶**.

"Random Title" appears on the screen, and titles will be played back in random order.

### Random playback of tracks

Press **RANDOM**.

"Random" appears on the screen, and random playback begins.

ENTER



PLAY



### ■ To change titles, chapters, or tracks during random play

- Press **▶▶▶** or **RANDOM** and the next randomly selected title, chapter, or track starts playing.
- Press **◀◀◀** and playback of the current title, chapter, or track starts again from the beginning.

### ■ To stop random play

Press **CLEAR**. This returns you to normal playback of chapters/tracks in order from the chapter/track currently playing.

#### Notes

- With Video CDs, random play is not possible during playback when the menu is displayed (PBC playback). To perform random play, start playback without displaying a menu by pressing a track number button while in the stop mode, and then press **RANDOM**.
- Random play of programmed chapters/tracks is not possible.
- In the case of DVDs, random playback may not be possible with some discs.
- Repeat playback of random playback is not possible. In these cases, the  mark will appear on the screen.

# Playing in a Favorite Order





The titles and chapters within a title on a DVD and similarly MP3, CD and Video CD tracks can be arranged to play in the order you want.

With this player, it is possible to make a program as you watch a DVD or Video CD or while listening to an MP3 or a CD.

DVD

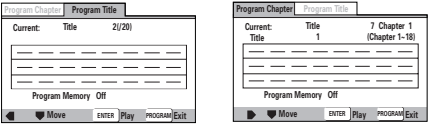
## Programming DVDs

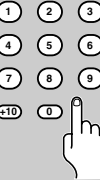
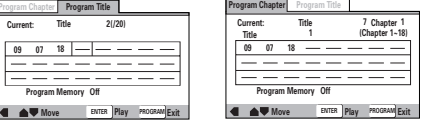
A program with a maximum of 24 steps can be memorized.

<p><b>1</b> PROGRAM</p> 	<p><b>Press PROGRAM.</b> The Program screen appears.</p> 
<p><b>2</b></p> 	<p><b>Use the cursor buttons (◀/▶) to select either [Program Chapter] or [Program Title].</b></p>
<p><b>3</b></p> 	<p><b>Once the program type is selected. Use the cursor button (▼) to enter the program window.</b> When [Program Chapter] is selected, you must also select what title the chapters to be programmed are in. Use the cursor button (▲) to highlight "Title" and then use the number buttons to enter the title number to be used.</p>
<p><b>4</b></p> 	<p><b>In the program window, use the number buttons to enter the numbers of the titles or chapters in the order you want to program them in.</b></p> <ul style="list-style-type: none"> <li>To program DVD titles/chapters 9, 7, and 18 in order, press 9, 7, +10 and 8.</li> </ul> 
<p><b>5</b></p>  	<p><b>Press ENTER or ►.</b></p> <ul style="list-style-type: none"> <li>Playback starts in the set order.</li> <li>Press PROGRAM to return to the previous display. The program will not begin until ► is pressed.</li> </ul>

### ■ To program a pause in a program

Press **II** instead of a number button.

"II" appears on the screen and the pause can be programmed. A pause cannot be programmed as the first or last position in a program, and two or more pauses cannot be programmed in succession.

### ■ To delete a number:

Use the cursor buttons (▲/▼/◀/▶) to highlight the incorrect number and then press CLEAR.

The number is deleted. If the number was before another number, the later numbers are reordered automatically.

### ■ To insert a number:

Use the cursor buttons (▲/▼/◀/▶) to highlight the number to be placed after the new number and then press the number button(s) of the number to be inserted.

The new number is inserted before the previously selected number.

### ■ To stop program play

Press **■**.

### Notes

- When programming chapters, chapters not programmed may appear on the screen. This is not a malfunction.
- Programming may not be possible with certain DVD discs. On these types of discs, the  mark will appear on the screen when programming is attempted.
- Only chapters within the same title can be programmed during chapter programming.

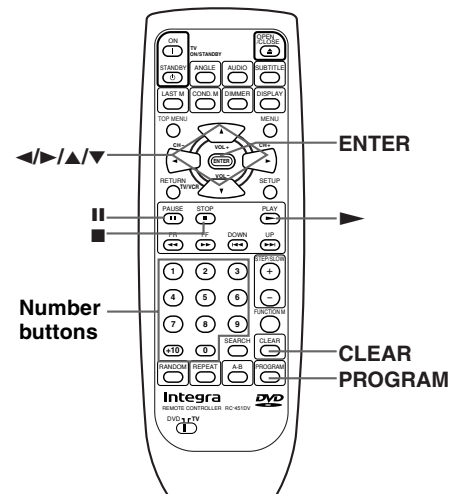

MP3

## Programming MP3s

A program with a maximum of 24 steps can be memorized.

### ■ Navigate using the following controls:

- |               |  |
|---------------|--|
| Cursor button | Navigate the program list.                             |
| CLEAR         | Clear the currently selected item in the program list. |
| ENTER         | Start playing the program list.                        |
| PROGRAM       | Exit the [MP3 Program] screen.                         |



### 1 Press PROGRAM to enter the [MP3 Program] screen.

If you added tracks to the program list from the 'Using the MP3 navigator' on page 41, the tracks are displayed here.

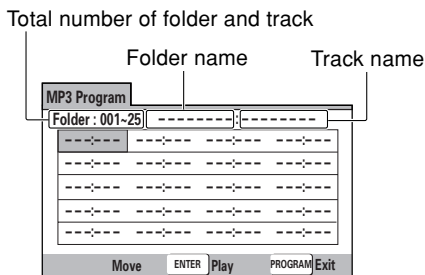

From this screen you can enter folder and track numbers directly to build up a program list.

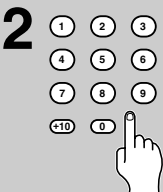

### 2 Use the number buttons to enter a three-digit folder number.

The number of folders on the disc is displayed in the top-left of the screen.

Once you've entered a valid folder number, the name of the folder appears.

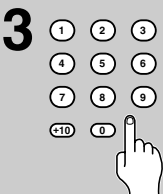
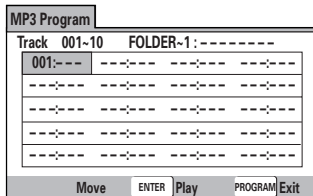

### 3 Use the number buttons to enter a three-digit track number.

The number of tracks in the current folder is displayed in the top-left of the screen.

Once you've entered a valid track number, the name of the track appears.

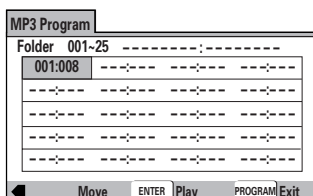

# Playing in a Favorite Order

VCD CD

## Programming Video CDs, CDs

A program with a maximum of 24 steps can be memorized.

**1**  **PROGRAM**

**Press PROGRAM.**

The program screen appears. When a Video CD or CD is loaded, the cursor appears in the program window.

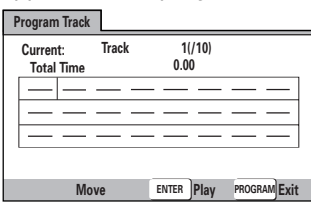

**2** 

**Use the number buttons to enter the numbers of the tracks in the order you want to program them in.**

- To program tracks 9, 7, and 18 in order, press 9, 7, +10 and 8.
- To edit the program, refer to the procedures on the previous page.

**3** 

**Press ENTER or ►.**

- Playback starts in the specified track order.
- To stop the program play, press ■.

### Notes

- To program a pause, or to add or delete a number, refer to the procedures for 'Programming DVDs' on page 28.
- You cannot program when playing a Video CD using menu selections (during PBC).

DVD VCD CD MP3

## Additional programming options

After you have made a program, it is then possible to confirm, add, or clear the contents of the program.

### ■ To confirm the contents of a program:

On a CD or Video CD track program, press PROGRAM to confirm.

The program screen displays the current program.

On a DVD, select the program type (title or chapter) with the cursor buttons (◀/▶).

The current DVD title or chapter program can then be confirmed on the appropriate program screen.

### ■ To add to a program:

- 1 Press PROGRAM.
- 2 Press a number button to add a new title, chapter, or track at the end of the program.
- 3 Press PROGRAM to exit the program screen.

### ■ To delete a program:

- 1 Press PROGRAM.
- 2 Select the program with the cursor buttons (◀/▶), then press CLEAR.
- 3 Press PROGRAM to exit the program screen.

### Notes

- The complete program will be deleted even if the disc tray is open or power off (standby).
- Pressing CLEAR when the disc is stopped will clear all programs.

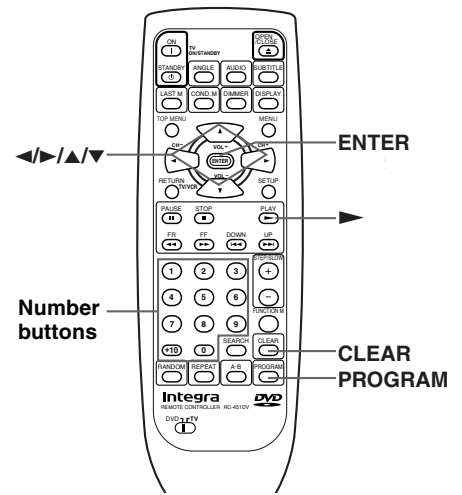

### ■ To add a title/chapter/track to a program

Press and hold PROGRAM for about 2 seconds. The current title/chapter/track number appears on-screen together with the program step number. If there isn't already a program then a new one will be created.

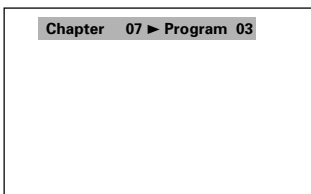

### ■ To confirm the contents of a program:

Press PROGRAM.

#### Notes

- When using this function to program DVDs, the program being created corresponds to the Program screen (chapter or title) that appears when PROGRAM is pressed. Be sure to check that the appropriate program type is selected.
- You cannot make a program containing chapters in different titles.

### ■ To save a program in memory

This player can memorize the programs on up to 24 DVDs. By turning the [Program Memory] to [On], the player will save your program and recall it the next time you use the same DVD. When the program memory exceeds 24, programs will be erased in chronological order from the oldest program in memory.

- 1 Use the cursor button (▼) to highlight [Program Memory] and use the cursor button (▶) to select [On].

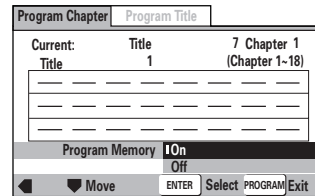

- 2 Press ENTER. The program is saved in memory.

#### Note

When a DVD with a program stored in memory is loaded, program playback may start automatically.

### ■ To erase a program saved in memory

The player erases programs in chronological order when the maximum number of programs that can be held in memory is exceeded. To prevent the player from erasing older programs that you may still use regularly, or when you don't want to use a program anymore, it is possible to manually erase programs stored in memory.

- 1 Load a DVD that has a program stored in memory.
- 2 Press PROGRAM. The program screen appears.
- 3 Use the cursor button (▼) to highlight [Program Memory] and use the cursor buttons (▶/▼) to select [Off].
- 4 Press ENTER. The program is cleared from memory.





# Selecting the Audio/ Subtitle Language

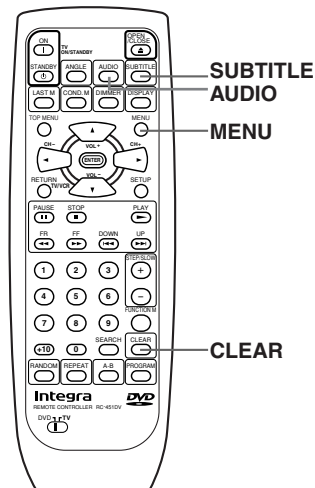

DVD

## Changing the Audio Language (Multi-Language Function)

Dolby Digital, PCM, and other audio data can be recorded on DVDs in a number of languages or audio tracks, letting you choose the desired language or audio.

AUDIO

**Press AUDIO repeatedly to select the desired language.**

Pressing AUDIO once displays the currently selected language. Subsequent presses rotate through the audio languages available on the DVD.

### Notes

- You cannot switch languages if there is only one language recorded on the disc.
- Switching the audio language may not be possible with some titles. In this case, the mark is displayed.
- For some titles, selection can be made using the DVD menu. In these cases, press MENU to display the DVD menu screen and then make your selection.
- When you erase the resume position or replace a disc, the DVD player returns to the automatic setting in the setting menu (page 47)
- CDs recorded in DTS format are not compatible with this player. Please do not change the audio language.

## Changing Audio Type

For enjoyment of karaoke or similar format Video CDs, CDs and MP3s, it is possible to select stereo audio, or either right or left channel mono depending on the requirements of the source. Press AUDIO repeatedly during playback to switch the audio type.

Audio output changes from [1/L] (Left channel) to [2/R] (Right channel) to [Stereo].

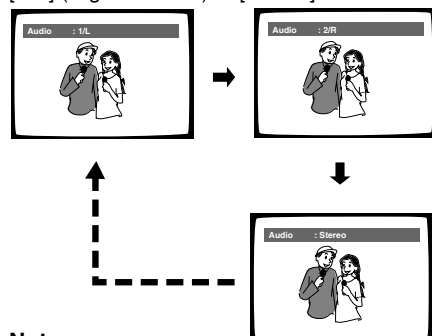

### Note

With karaoke and other discs, set the appropriate audio type for singing and accompaniment after referring to information on the disc jacket or accompanying material.

DVD

## Selecting a Subtitle Language (Multi-Language Subtitles)

You can select a desired subtitle language with DVDs that have subtitle data in multiple languages recorded on them.

SUBTITLE

**Press SUBTITLE repeatedly during playback.**

Pressing SUBTITLE once displays the currently selected subtitle language. Subsequent presses rotate through the subtitle languages available on the DVD.

### Notes

- The subtitle language cannot be switched if the subtitle language is not recorded, or if only one language is recorded.
- Switching the subtitle language may not be possible with some discs. In this case, the mark will be displayed.
- To clear subtitles during playback, press SUBTITLE and then press CLEAR, or press SUBTITLE until [Off] appears.
- For some discs, subtitle language selection can be made using the menu on the DVD. In this case, press MENU to display the DVD menu screen and then make your selection.
- When you erase the resume position or replace a disc, the DVD player returns to the automatic setting in the setting menu (page 48)

# Continuing Playback from a Specified Location (Last Memory)

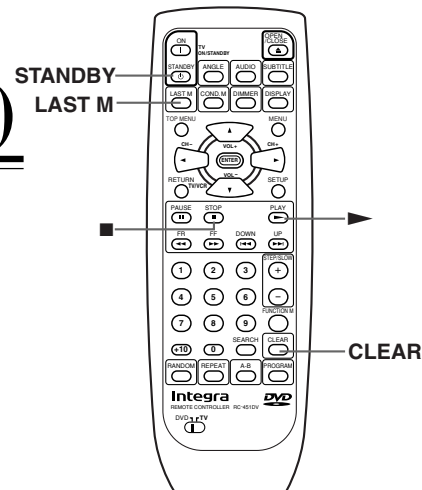

The Last Memory function is convenient when you want to continue viewing a disc from the point where you were watching before. Unlike the resume function, the Last Memory function is effective even if the DVD is removed from the player (Last Memory locations saved for Video CDs are effective only if the disc remains loaded in the player).

Last Memory may not work reliably with some Video CDs that feature PBC.



DVD VCD

## Memorizing a Last Memory location to return to later

<b>1</b>		<p><b>Press LAST M during play.</b> The "LAST" indicator lights on the player.</p>
<b>2</b>		<p><b>Press STANDBY to turn the power to standby, or stop playback with ■.</b> Once memorized, the memorized point will be recalled even if the power is turned off, or if the disc is ejected. Points on up to 5 discs can be memorized, and those points are recalled the next time any of the discs are played back.</p> <ul style="list-style-type: none"> <li>• A Last Memory point can be memorized for only one Video CD at a time as the function is only effective until the Video CD is removed from the player.</li> </ul>

DVD VCD

## Resuming playback from where LAST MEMORY was pressed

<b>1</b>	<p><b>Load a disc that has a Last Memory point memorized.</b> Some DVDs will start playback automatically when loaded. In this case, press ■ to stop playback.</p>	
<b>2</b>		<p><b>Press LAST M while in the stop mode.</b> The disc begins playback at the memorized point.</p> <ul style="list-style-type: none"> <li>• Last Memory mode may not function for some DVDs.</li> <li>• You can use Last Memory for up to five discs (after that the one used least recently is deleted to make space for a new one).</li> <li>• Even with a disc you have memorized with Last Memory, playback begins at the start of the disc if you press ►.</li> <li>• This function is for playback of DVDs or Video CDs only. You cannot use it with CDs and MP3s.</li> </ul>

### ■ To clear the Last Memory location

- 1 Load a disc that has a Last Memory point memorized.  
Some DVDs will start playback automatically when loaded. In this case, press ■ to stop playback.
- 2 Press LAST M while in the stop mode.  
The disc begins playback at the memorized point.
- 3 Once the picture appears, press LAST M again.
- 4 While "Last Memory" is displayed on the screen, press CLEAR.  
The "LAST" indicator disappears from the display.



# Viewing Disc Information

Use **DISPLAY** to get current information about the disc currently loaded. You can get information about the titles and chapters on a DVD or tracks on a Video CD or CD or folders and tracks on a MP3. When viewing DVDs, you can also check the digital bitstream transmission rate.



## Viewing Disc Information during while a disc is playing



**Press DISPLAY during while a disc is playing. Press DISPLAY repeatedly to change the information being displayed.**

The disc information is displayed superimposed over the video image on the screen.

**Press and hold DISPLAY to display the time remaining on the disc.**

When you release the button, the information disappears.

The display changes for each type of disc as follows each time the button is pressed.

### DVD

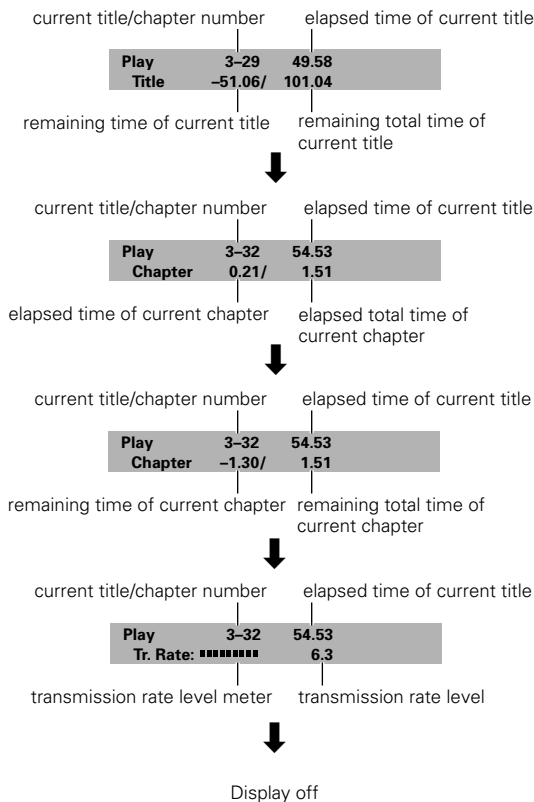

### Video CD (with PBC disabled)

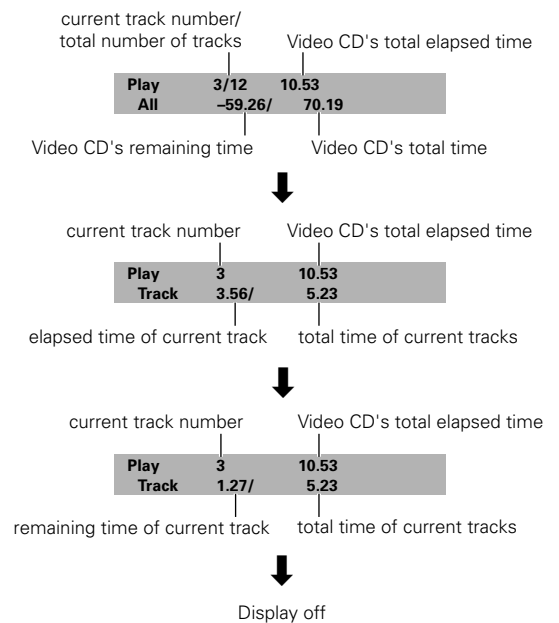

### CD

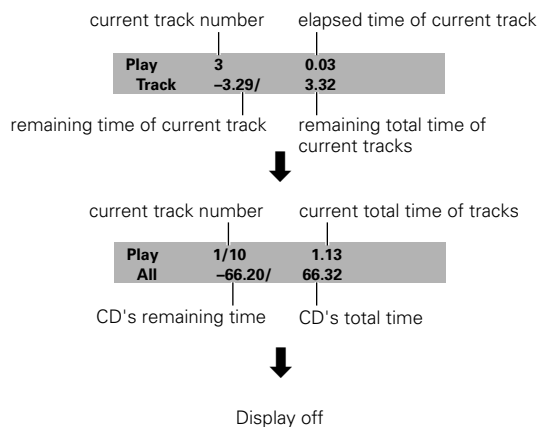

## ■ Using DIMMER function

Press DIMMER to change the display brightness.  
 Each time DIMMER is pressed, the display brightness of the unit changes as shown below.  
 Normal → Dim → Very Dim → Normal

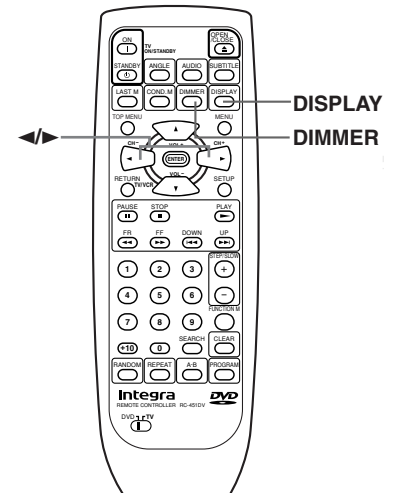

### MP3

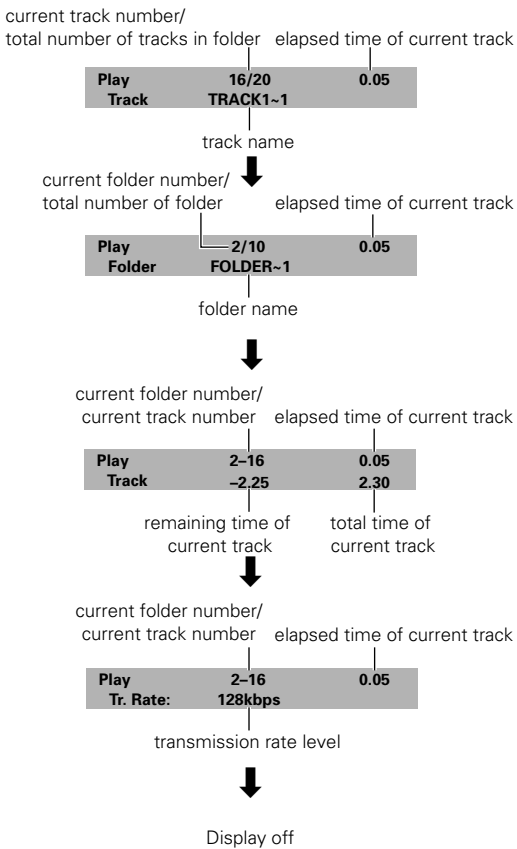

### Notes

- Depending on the format and type of disc being used, not all screens may be displayed.
- When playing Video CDs in PBC mode or unfinalized CD-Rs not all the above information is displayed.

DVD VCD CD MP3

## Viewing Disc Information during while a disc is stopped

DISPLAY



Press DISPLAY during while a disc is stopped to display DVD title and chapter information or Video CD and CD track information or MP3 folder and track information. Press DISPLAY again to turn the display off.

Information about the titles and chapters or folders and tracks on a disc is displayed. When the information exceeds the space on the screen, use the cursor buttons (◀/▶) to move to other screens.

### DVD

Information: DVD			
Title	Chapter	Title	Chapter
01	1 ~ 30	06	1 ~ 10
02	1 ~ 21	07	1 ~ 13
03	1 ~ 46	08	1 ~ 5
04	1 ~ 12	09	1 ~ 4
05	1 ~ 8	10	1 ~ 8

1/2 ▶ DISPLAY Exit

Titles and number of chapters in each title

### Video CD and CD

Information: Compact Disc			
Total time		72.04	
Track	Time	Track	Time
01	5.23	06	6.51
02	4.55	07	3.18
03	6.13	08	6.50
04	5.45	09	4.16
05	5.10	10	3.22

1/2 ▶ DISPLAY Exit

Total playing time of disc, tracks and track times

### MP3

Information: MP3			
Folder	Track	Folder	Track
01	1 ~ 9	01	1 ~ 10
02	1 ~ 11	02	1 ~ 13
03	1 ~ 3	03	1 ~ 5
04	1 ~ 22	04	1 ~ 4
05	1 ~ 15	05	1 ~ 8

1/2 ▶ DISPLAY Exit

Folders and number of tracks in each folder

# Adjusting Audio and Video Settings

The procedure on this page describes how to operate the menus on the Setup screen. These menus are used to set and adjust a number of system settings. The various functions that can be adjusted are covered throughout this manual. The procedure on this page provides a basic outline for using the Setup screen menus.

## Using the Setup Screen Menus

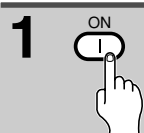

**1** Press ON (Standby/On on the front panel).



**2** Press SETUP.  
The Setup screen appears.  
Example

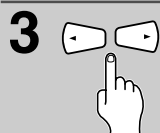
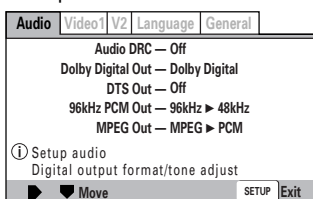

**3** Use the cursor buttons (◀/▶) to select the menu you want.  
As each menu is selected with the cursor, the settings appear below the menu heading.



**4** Use the cursor buttons (▼) to enter the menu.  
The top item within the menu becomes highlighted.  
Example

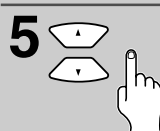
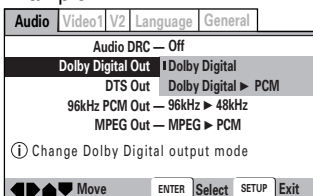

**5** Use the cursor buttons (▲/▼) to select the setting you want to change.  
The options available for each setting appear to the right when the setting is selected. The current setting appears with the setting indicator lit.



**6** Use the cursor buttons (▶) to enter the setting options.  
Example

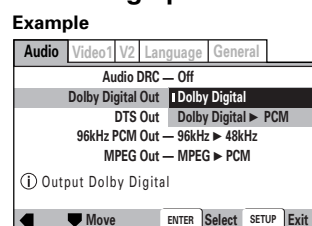

- Not all menu options can be changed while a disc is playing. In these cases, the options appear grayed out on the screen and cannot be adjusted. To change these settings, press ■ first before pressing SETUP.
- Operating the menu after pressing ■ may cancel the resume function.
- Some menu options are not immediately effective if set while a disc is playing. To make these settings effective, stop playback and then start again, or change the settings while the disc is stopped.

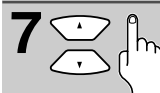

**7** Use the cursor buttons (▲/▼) to select a new setting and press ENTER to set the new setting in memory.

Press RETURN or the cursor button (◀) to exit the options without making any changes.

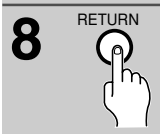

**8** Press RETURN or the cursor button (◀) to go back to the main menu bar to select another menu.

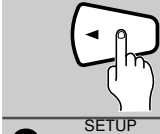

**9** Press SETUP to close the Setup screen.  
The Setup screen closes.

### Notes

- If you turn off the DVD player during setup, the settings are canceled. Press SETUP to finish the setup.
- The memorized resume position may be erased by setup.
- The Setup screen always shows the latest settings.

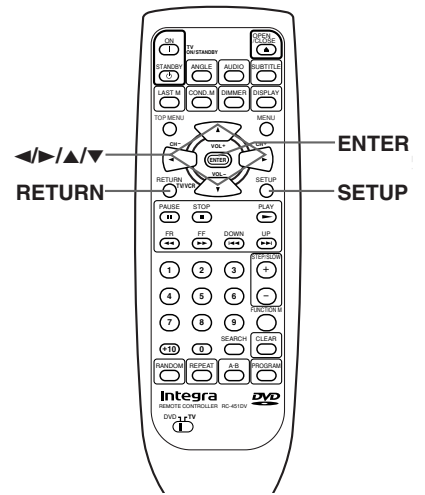

## Changing to the Setup Screen “Expert” Menu Mode

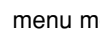
The Setup screen menus are divided into two levels, [Basic] and [Expert], to make this unit more convenient to operate for different levels of users. The [Basic] menu mode contains functions that may be considered necessary for the basic operations of this player and helpful on-screen information identified by the  mark. The [Expert] menu mode adds to the [Basic] menu mode additional functions of the player that can be adjusted to further personalize performance of the player. In this manual, functions that are contained in the [Expert] menu mode are identified by the  icon. Make changes to the [Setup Menu Mode] setting in the Setup screen General menu.

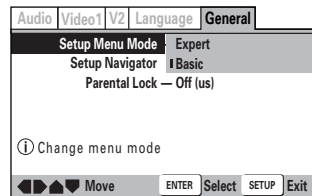

Settings: **Expert**  
**Basic** (Factory setting)

**Note**  
On-screen information only appears in the [Basic] menu mode .

## When setting up for the first time

It is recommended to set up player using the Setup Navigator (page 16). If you selected [Auto Start Off] when the Setup Navigator appeared, you may still set up the player using the Setup Navigator in the General menu screen.

If you choose not to use the Setup Navigator, be sure to make the necessary settings in the Setup screen Audio, Video 1, Video 2 and Language menus as described on the following pages.

Some DVDs start playing automatically when loaded in the player. If a DVD has been loaded, be sure to press  before proceeding.

### Note

The next time you press SETUP, you'll see the menu screen that you exited from last time.

## How to interpret the setting indicator colors in the Setup screen menus

When setting up the system, or when making adjustments, it is convenient to know what settings are applicable to the different disc formats. When the settings appear for each menu option, the currently selected setting appears with the setting indicator highlighted in one of three colors: blue, green or yellow. These colors correspond to what formats the menu option effects as shown in the table below.

Color of indicator	Disc format(s)
Blue	DVD only
Yellow	DVD/Video CD
Green	All compatible formats

### Note

If a setting applicable only to DVDs is changed while a Video CD or CD is loaded, a blue DVD icon appears in the upper right hand corner of the screen to indicate that the setting is not applicable to the currently loaded disc. The setting will be effective the next time a DVD is loaded.

# Adjusting Audio and Video Settings

## Adjusting the Dynamic Range of the Audio Soundtrack

Audio DRC stands for Audio Dynamic Range Compression. When Audio DRC is on, soft sounds such as dialog can be heard more clearly without making loud sounds even louder. Select from three levels of compression depending on how much effect you want. When Audio DRC is set to [Off], there is no effect on the audio source. Make changes to the [Audio DRC] setting in the Setup screen Audio menu.

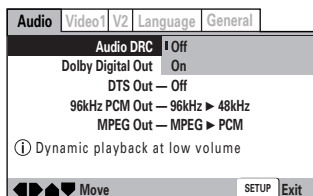

Settings: **Off** (Factory setting)  
**On**

### Notes

- Audio DRC is only effective with Dolby Digital audio sources.
- The level of Audio DRC may differ depending on the DVD.
- If you have set the [Dolby Digital Out] to [PCM] and the [Digital Out] setting to [On], the Audio DRC effect is output through the digital out jack.
- The effect of Audio DRC depends on your speakers and AV amplifier settings.

## Setting the Digital Audio Output

This player is capable of digital audio output for Dolby Digital, DTS, MPEG, and signals with a sampling rate of 96 kHz. Make settings in the Setup screen Audio menu to reflect the capabilities of the components that you have made digital connections to.

**Expert** denotes more detailed settings. If the item is not displayed, please refer to page 39 to display it.

### Notes

- If you have already completed the Setup Navigator screen operations, the settings on this page have already been set by the player.
- If you have made only stereo line connections (analog) using the supplied audio cord, it is not necessary to make any changes in this menu.

### ■ Dolby Digital Out

This player is capable of outputting the Dolby Digital surround sound audio signal. When the player is connected to an AV component that has a built-in Dolby Digital decoder, select [Dolby Digital]. This player can also convert the Dolby Digital signal to a digital Linear PCM signal, the same digital signal output from a CD. Select [Dolby Digital ▶ PCM] when you have made connections to an amplifier or receiver with a Dolby Pro Logic decoder or a Digital Analog Converter (DAC).

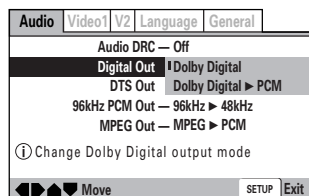

Settings: **Dolby Digital** (Factory setting)  
**Dolby Digital ▶ PCM**



## ■ DTS Out

This player is capable of outputting DTS digital audio for DVDs recorded in DTS. When this player is connected to an AV component that has a built-in DTS decoder, select [DTS]. If your system is not equipped to decode DTS, select [Off]. Refer to the operating instructions supplied with your audio components if you are unsure about compatibility with DTS.

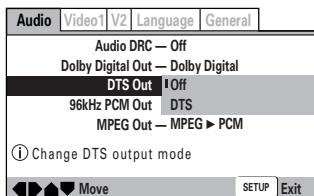

Settings: **Off** (Factory setting)  
**DTS**

### Note

If you have made digital audio connections to component(s) not equipped to decode the DTS digital bitstream, be sure to select [Off]. If a DTS signal is output without decoding, the output is digital noise that could potentially cause damage to your speakers.

## ■ 96 kHz PCM Out

This player is capable of outputting digital signals with a sampling frequency of 96 kHz. If you have made connections to a component capable of processing this signal rate, select [96 kHz] for the signal to be output as is. As some components are incapable of processing digital signal input with sampling rates of 96 kHz, selecting [96 kHz ▶ 48 kHz] compresses the signal to a standard signal with a sampling rate of 48 kHz.

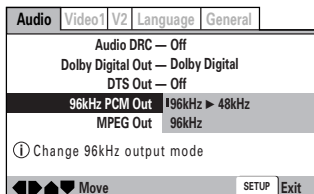

Settings: **96 kHz ▶ 48 kHz** (Factory setting )  
**96 kHz**

### Note

On DVDs that contain copy protection, the 96 kHz signal may only be output from the analog audio jacks.

## ■ MPEG Out

This player is capable of outputting the MPEG digital bitstream. When the player is connected to an AV component that has a built-in MPEG decoder, select the [MPEG] setting. Otherwise, select [MPEG ▶ PCM] to convert the digital signal to the PCM signal, the digital signal output from a CD.

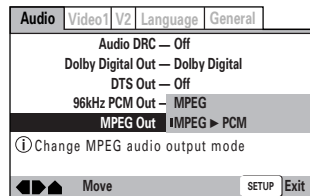

Settings: **MPEG**  
**MPEG ▶ PCM** (Factory setting)

## ■ Digital Out Expert

Depending on your preferences and the type of connections made, you may opt not to have the digital audio signal output at all. When this setting is set to [Off] there is no signal output from the digital audio output jacks.

Make changes to the [Digital Out] setting in the Setup screen Audio menu in the [Expert] menu mode (page 39).

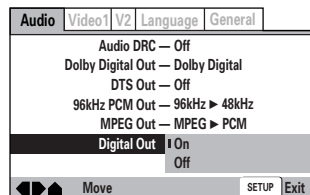

Settings: **On** (Digital bitstream is output) (Factory setting)  
**Off** (Digital bitstream is not output)

# Adjusting Audio and Video Settings

## Setting the TV Screen Size

The width-to-height ratio of conventional TVs is 4:3, while the width-to-height ratio of wide screen and high-definition TVs is 16:9. This width-to-height ratio is called the aspect ratio.

When viewing software recorded in different aspect ratios, the image's height to width ratio can be switched to match the TV or monitor being used.

Make changes to the TV screen size in the [TV Screen] setting in the Setup screen Video 1 menu. Please note that changes to the [TV Screen] setting cannot be made when a disc is playing. Stop playback of the disc before attempting to make any changes.

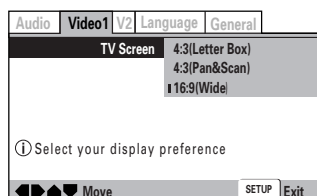

Settings: **4:3 (Letter Box)**  
**4:3 (Pan & Scan)**  
**16:9 (Wide)** (Factory setting)



### Notes





- If [Standard (4:3)] is selected in the Setup Navigator screen, [4:3 (Letter Box)] is selected on this screen. If you prefer the pan&scan format, change the settings on this screen.
- Whether the aspect can be switched or not depends on the disc. Please refer to the information written on the disc jacket, etc.
- Some discs may not include the screen format selected in the [TV Screen] setting. When this occurs, the standard TV screen format available on the disc is automatically selected.

### ■ Differences in screen sizes and DVD formats

The number of screen size formats currently available can be somewhat confusing. If set incorrectly, the video presentation may not appear as it should. The following diagrams and descriptions are intended to help you set your TV screen size in a way that will allow you to fully enjoy the digital video of DVD.

The settings in the [TV Screen] setting are perhaps most applicable when the DVD you are watching is programmed in the wide screen format. If you have a standard TV, select either [4:3 (Letter Box)] or [4:3 (Pan & Scan)] based on your personal preference. If you have a wide screen TV, select [16:9 (Wide)].

When viewing a wide screen TV or monitor	
DVD screen size format	Setting and Appearance
<b>Wide screen format DVD</b> Please note that there are some wide screen letter box formats that place black bars at the top and bottom of the screen. This is not a malfunction.	 <p>"Wide" setting</p>
<b>Standard screen format DVD</b> When viewing a standard screen format DVD on a wide screen TV, black bars may be automatically placed at the side of the screen to adjust to the DVD format.	 <p>"Wide" setting</p>
<b>Standard screen format DVD (unnatural stretched effect)</b> If you are viewing a standard screen format DVD on a wide screen TV, the picture may appear 'stretched' on the screen. To remedy this condition, change your wide screen TV to display a standard (4:3) screen. Refer to the instructions supplied with your wide screen TV or monitor for more information.	 <p>"Wide" setting</p>

When viewing a standard size TV or monitor	
DVD screen size format	Setting and Appearance
<b>Wide screen format DVD</b> The Letter box presentation places black bars at the top and bottom portions of the screen to provide the full wide screen presentation of a movie on a standard TV (4:3 aspect ratio).	 <p>"Letter Box" setting</p>
<b>Wide screen format DVD</b> The Pan & Scan presentation crops both sides of the wide screen presentation to use the full standard TV screen.	 <p>"Pan &amp; Scan" setting</p>
<b>Standard screen format DVD</b> If you have a standard TV, the standard screen format will be presented regardless of the setting.	 <p>Any setting</p>
<b>Wide screen format DVD (unnatural squeezed effect)</b> If you are viewing a wide screen format DVD on a standard TV and the [TV Screen] setting is set to [16:9 (Wide)], the picture may appear 'squeezed' on the screen. To remedy this condition, select either [4:3 (Letter Box)] or [4:3 (Pan & Scan)].	 <p>"Wide" setting</p>

## Setting the Video 1 Options

**Expert** denotes more detailed settings. If the item is not displayed, please refer to page 39 to display it.

### ■ Setting the Component Video Output

Compared to a standard interlaced TV picture, a progressive scan TV is capable of stable, flicker-free images. Set only if you connected the COMPONENT VIDEO OUT jacks to a progressive scan-compatible TV or monitor. Make changes to the [Component Video] setting in the Setup screen Video 1 menu.

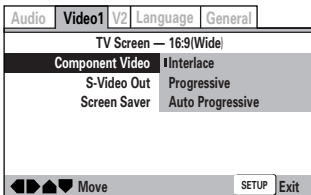

Settings: **Interlace** (Factory Setting)

Use this setting with regular TVs that are not compatible with progressive scan. Check the TV's instruction manual if you are not sure about this.

#### Progressive

Use this setting with TVs and monitors that have progressive scan component video inputs. The PROGRESSIVE indicator lights up. Check the TV's instruction manual if you are not sure about this.

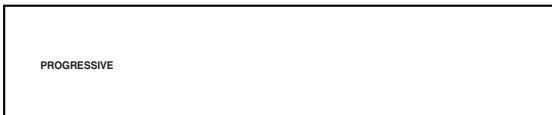

#### Auto Progressive

Switches to progressive scan when 16:9 DVDs are played, 4:3 DVDs uses interlace setting. Your TV/monitor must be compatible with progressive scan to use this setting.

#### Tip

If this player is set to output progressive-scan video, it's possible that the picture will appear stretched when playing discs recorded in 4:3 format. This happens when the TV's aspect ratio is set at 16:9. To see the picture in its correct aspect ratio, change the TV setting to 4:3.

If your TV can not be switched between 4:3 and 16:9, set this player to [Interlace] or [Auto Progressive]. In Auto progressive mode, 4:3 discs will be played in Interlace mode, while discs that are recorded in both 4:3 and 16:9 will play in interlace mode during the 4:3 sections, and in progressive mode during the 16:9 parts. Switch your TV's aspect ratio to the most suitable setting (for more details, see the manual that came with your TV). When set to [Auto Progressive], you may see picture disturbance when this player (and the TV) switches between progressive and interlace modes. This is not a malfunction of either this player or the TV. Picture disturbance should only occur when switching from a menu screen to the main feature, for example.

#### Note

If you connect a TV that is not compatible with a progressive scan signal and choose one of the progressive scan settings, you will not be able to see any picture at all. With your TV connected using either the composite or S-Video terminals, choose the [Interlace] setting in the [Component Video] menu.

### ■ Switching the S Video Output **Expert**

You can Switch the kind of S Video signal output from the S Video outputs. If you connected your TV with an S Video cord, in rare cases the TV picture may appear stretched. In this case switch the output from [S2] to [S1]. Make changes in the [S-Video Out] in the Setup screen Video 1 menu in the [Expert] menu mode (page 39).

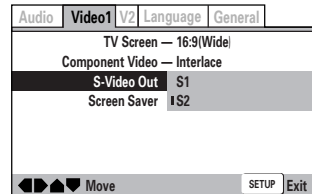

Settings: **S1**

**S2** (Factory Setting)

### ■ Turning the Screen Saver On and Off **Expert**

As a protective function against residual images on the TV screen or monitor, a phenomenon referred to as "screen burn", the screen saver appears when the same screen has been displayed for a length of time. By default, the screen saver is turned on. However, the screen saver function can be turned on and off at your discretion.

Make changes to the [Screen Saver] setting in the Setup screen Video 1 menu in the [Expert] menu mode (page 39).

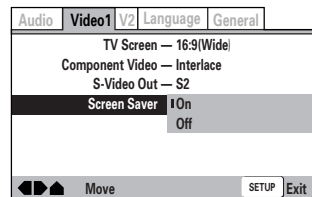

Settings: **On** (Factory setting)

**Off**

#### Note

Pressing **II** (or **▶**) displays a playback screen, and pressing **II** (or **▶**) again resumes playback.

# Adjusting Audio and Video Settings

## Adjusting the Video Quality

You can either select a preprogrammed setting designed to match certain program types or make adjustments to match your own preferences and save them in the player's memory. Make changes to the [Video Adjust] setting in the Setup screen Video 2 menu.

**Expert** denotes more detailed settings. If the item is not displayed, please refer to page 39 to display it.

### ■ Selecting a preprogrammed setting

- 1 Use the cursor button (▶) to select [Start] then press ENTER.

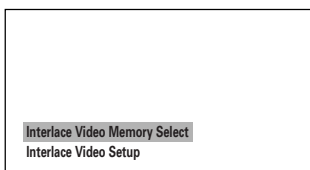
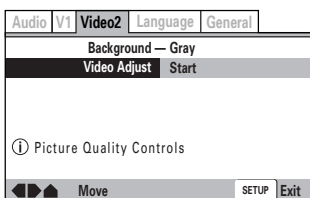

- When setting [Component Out] to [Interlace] in the Setup screen Video 1 menu, select [Interlace Video Memory Select], then press ENTER.
- When setting [Component Out] to [Progressive] in the Setup screen Video 1 menu, select [Progressive Video Memory Select], then press ENTER.

- 2 Use the cursor buttons (◀▶/▲▼) to select one of the preprogrammed picture quality settings.

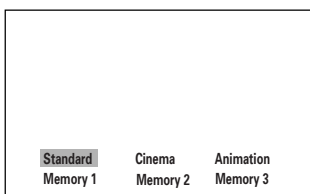

#### Standard (Factory Setting):

Presents the video with no effect added.

#### Cinema:

Delivers a cinema-like picture.

#### Animation:

Provides images with bright clear colors.

#### Memory 1, Memory 2, and Memory 3:

These are user programmable settings. See 'Adjusting the picture quality settings' on pages 44 and 45 for more information.

If there is a DVD or Video CD playing, the effects of each setting can be viewed while it is highlighted on the screen. This may be useful in selecting an appropriate setting.

- 3 Press ENTER.  
The new selection is set.

### Notes

- Each picture quality setting is defined by a number of individual settings, described in 'Adjusting the picture quality settings' on pages 44 and 45.
- Depending on the disc and the TV/monitor, you may not see the effect clearly.

### ■ Adjusting the picture quality settings – To create your own setting (1)

- 1 Use the cursor button (▶) to select [Start] then press ENTER.

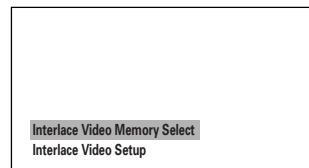

- 2 Use the cursor button (▼) to select [Video Setup] then press ENTER.

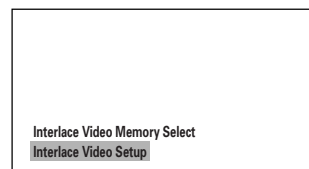

- 3 Use the cursor buttons (◀▶) to select the setting to [On] or [Off].

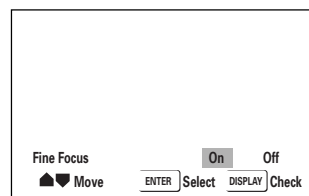

- 4 Use the cursor buttons (▲▼) to select the setting to adjust. You can adjust any or all of the following picture quality factors:

#### <Interlace video settings>

##### Fine Focus

Switch on to reveal greater detail (higher resolution) in the picture.

##### Contrast

Adjusts the contrast of the elements in the picture.

##### Sharpness

Adjusts the sharpness of the mid-frequency (less detailed) elements in the picture. (This setting is only effective when [Fine Focus] is [On].)

##### Chroma Level

Adjusts how saturated colors appear.

##### Hue

Adjusts the overall color balance between red and green. (This is only effective when the player is connected using the VIDEO OUT or S-VIDEO OUT jacks.)

#### <Progressive/auto progressive video settings>

##### DNR

Reduces noise.

##### Sharpness

Adjusts the sharpness of the mid-frequency (less detailed) elements in the picture.

##### Detail

Enhances picture edges.

##### Chroma delay

Adjusts luminance (Y) and color (C).

##### Gamma

Adjusts the black level.

- Use the cursor buttons (◀/▶) to adjust the settings.  
Adjust these while a disc is playing to see the effect of changes immediately.

- Repeat steps 4 and 5 to make adjustments to other settings.

If you would like to save the settings in the player's memory, be sure to select either [1], [2], or [3] in the [Memory] setting to establish which memory location to save the new settings in. Please note that if you select a location where settings have already been saved, the old settings will be replaced by the new ones.

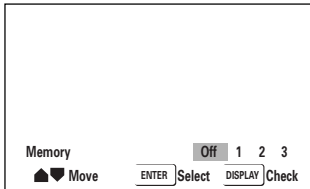

- When you are finished making adjustments, press ENTER to establish the new settings.

## ■ Adjusting the picture quality settings – To create your own setting (2)

- Use the cursor button (▶) to select [Start] then press ENTER.

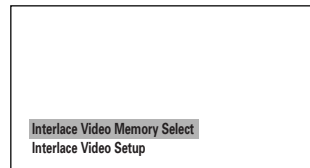

- Use the cursor button (▼) to select [Video Setup] and press ENTER.
- Press DISPLAY.

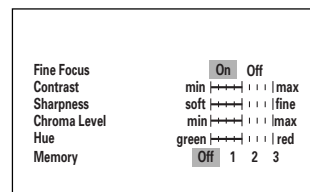

- Use the cursor buttons (▲/▼) to select the setting and use the cursor buttons (◀/▶) to adjust the settings.  
Adjust these while a disc is playing to see the effect of changes immediately.
- To memorize the setting, select Memory 1, 2, 3, then press ENTER.  
The previous setting will be erased.

# Adjusting Audio and Video Settings

## Setting the Video 2 Options

**Expert** denotes more detailed settings. If the item is not displayed, please refer to page 39 to display it.

### ■ Changing the Background of the Screen

You can select a background to appear when the player is in the stop mode.

Make changes to the [Background] setting in the Setup screen Video 2 menu.

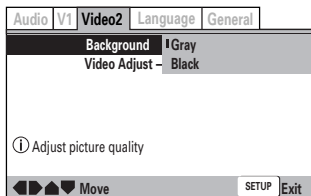

Settings: **Gray**  
**Black**

### ■ Selecting the Type of Paused Image to Display **Expert**

This function lets you view a clear still-image when DVD playback is paused.

Make changes in the [Still Picture] setting in the Setup screen Video 2 menu in the [Expert] menu mode (page 39).

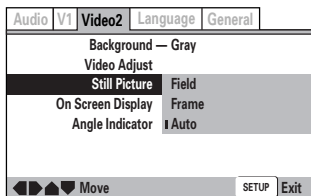

Settings: **Field** (Picture shake will be eliminated during a paused picture.)

**Frame** (Select to obtain higher picture quality.)

**Auto** (Selects [Field] or [Frame] automatically according to the disc.) (Factory setting)

### ■ Setting the Position of the On-screen Display **Expert**

When watching conventional software on a wide screen TV, the operation display is at the very top of the screen, and may be difficult to see. Changing the position of the display lets you see operation indicators clearly even on a wide screen TV. Alternatively, you can choose to turn them off completely with the [Off] setting.

Make changes in the [On Screen Display] in the Setup screen Video 2 menu in the [Expert] menu mode (page 39).

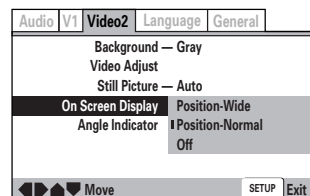

Settings: **Position-Wide**  
**Position-Normal** (Factory setting)  
**Off**

#### **Note**

This setting is only effective with DVDs that contain a 4:3 aspect ratio video presentation.

### ■ Turning the angle indicator on and off **Expert**

When a picture recorded in different angles is played back  is displayed on the screen. This setting lets you see clearly whether the playback picture is recorded in multiple angles or not.

Turn the angle indicator on or off in the [Angle Indicator] setting in the Setup screen Video 2 menu in the [Expert] menu mode (page 39).

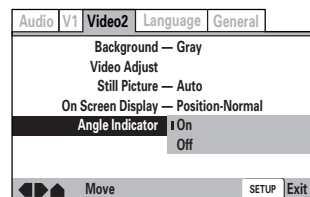

Settings: **On** ( is displayed) (Factory setting)  
**Off** (Not Displayed)

#### **Note**

Even when the [Angle Indicator] setting is set to [Off], the  indicator in the display panel of the player lights during multi-angle playback. Therefore, it is possible to know when the multi-angle function can be used without having to display the icon on the screen.

## Setting the Language Options

DVDs have the capacity to contain a great deal of audio information, which includes the ability to hold up to 8 different language tracks and subtitle information in as many as 32 different languages. This section outlines the variety of audio language and subtitle options available with this player. Please note that if you have completed the Setup Navigator, the audio and subtitle language options have automatically been set in accordance with the [OSD Language] (the language that appears on the screen).

### Note

DVDs differ in content and do not all contain multiple language or subtitle information. Therefore making settings in this section may have no effect on some DVDs.

### ■ Setting the On-screen Display (OSD) Language

This setting is used to establish the language that operation indicators and on-screen messages and operations display. Change this setting in the Setup screen Language menu [OSD Language] setting.

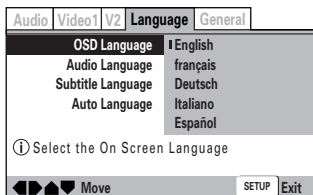

Settings: **English** (Factory setting)  
**français**  
**Deutsch**  
**Italiano**  
**Español**

### Notes

- The menu settings may be different from those shown above.
- The [OSD Language] setting is factory set to [English]. If you want English to be displayed, it is not necessary to adjust this setting.

### ■ Selecting an audio language preference

The audio language that you normally listen to can be selected from the various audio languages on a DVD. Even when the audio language is changed during playback by pressing AUDIO, the language selected at this setting will be selected as the default when the DVD is changed. Make changes to the [Audio Language] setting in the Setup screen Language menu.

You cannot make this setting with a disc playing.



Settings: **English** (Factory setting)  
**French**  
**German**  
**Italian**  
**Spanish**  
**Other** (For details on how to select other languages, see 'When [Other] is selected' on page 49.)

### Note

The menu settings may be different from those shown above.



# Adjusting Audio and Video Settings

## Setting the Language Options

**Expert** denotes more detailed settings. If the item is not displayed, please refer to page 39 to display it.

### ■ Selecting a subtitle language preference

The subtitle language that you will normally display can be selected from the subtitles programmed on a disc. Even when the subtitle language is changed during playback by pressing SUBTITLE, the language selected at this setting will be selected when the disc is changed.

Make changes to the [Subtitle Language] setting in the Setup screen Language menu.

You cannot make this setting with a disc playing.



Settings: **English** (Factory setting)

**French**  
**German**  
**Italian**  
**Spanish**

**Other** (For details on how to select other languages, see 'When [Other] is selected' on page 49.)

#### Note

The menu settings may be different from those shown above.

### ■ Setting Auto Language to control subtitle and audio language based on program content

When the Auto Language function is used, foreign movies are shown with the original audio soundtrack and subtitles in the language selected in the [Subtitle Language] menu option. Domestic films are shown with the original audio soundtrack and no subtitles. (This setting may not be effective with all DVD discs.)

Make changes to the [Auto Language] setting in the Setup screen Language menu.

You cannot make this setting with a disc playing.

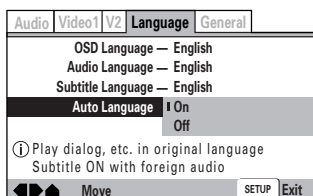

Settings: **On** (Factory setting)

**Off**

#### Note

The Auto Language function operates only when this function is set to [On], and the language set for the [Audio Language] and [Subtitle Language] settings is the same.

### ■ Selecting a DVD menu language preference

**Expert**

In addition to containing different audio languages, DVD may also contain menu screens in different languages as well. Setting a DVD language preference, sets the selected language as a default when DVDs with menu information in that language are encountered.

Selecting [w/ Subtitle Language] automatically assigns the language selected in the [Subtitle Language] setting.

Make changes to the [DVD Language] setting in the Setup screen Language menu in the [Expert] menu mode (page 39).

You cannot make this setting with a disc playing.



Settings: **w/ Subtitle Language** (Factory setting)

**English**  
**French**  
**German**  
**Italian**  
**Spanish**

**Other** (For details on how to select other languages, see 'When [Other] is selected' on page 49.)

#### Notes

- The menu settings may look different from the one shown above.
- If this function is not effective, the languages that can be selected may also be selected in the DVD menu. Press MENU to open the DVD menu and make your selection accordingly.



## ■ Selecting subtitles, assist subtitles or no subtitles Expert

Use this function to turn the subtitles on or off. Additionally, some DVDs provide assist subtitles that provide additional explanations of scenes in addition to the standard subtitles for viewers who are hard of hearing. Select [Assist Subtitle] to display these subtitles on DVDs where this function is offered. Make changes to the [Subtitle Display] setting in the Setup screen Language menu in the [Expert] menu mode (page 39). You cannot make this setting with a disc playing.

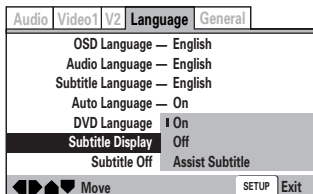

Settings: **On** (Factory setting)  
**Off**  
**Assist Subtitle**

### Notes

- If there is no subtitle information recorded on the DVD, no subtitles are displayed even if this function is set to [On].
- This setting serves as a default as whether or not to display subtitles. Even if this option is set to [Off], subtitles can be displayed by pressing SUBTITLE. Similarly, if this option is set to [On], the subtitles can be turned off by pressing SUBTITLE and then CLEAR.

## ■ Forcing subtitles to be displayed Expert

Even when the subtitles are turned off, some DVDs will nevertheless display them on the screen. This setting allows you to select the language of the subtitles to be displayed with this type of DVD.

Select [With Audio] to display the subtitles in the same language as the currently selected Audio Language. Select [Selected Subtitle] to display the subtitles in the language set in the [Subtitle Language] setting.

Make changes to the [Subtitle Off] setting in the Setup screen Language menu in the [Expert] menu mode (page 39).

You cannot make this setting with a disc playing.

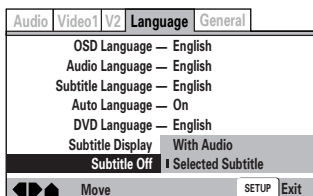

Settings: **With Audio**  
**Selected Subtitle** (Factory setting)

## ■ When [Other] is selected

When you want to select one of the 136 languages as the main audio language, follow the steps below when the following screen appears.

A language code list can be found on page 50.

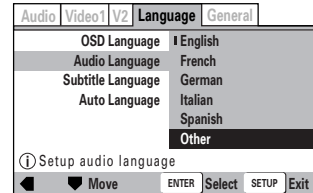

- 1 Use the cursor buttons to select [Other] and press ENTER. The language selection screen appears.



- 2 Use the cursor buttons (◀/▶) to select either "List of Languages" or "Code".
- 3 If you select "List of Languages", use the cursor buttons (▲/▼) to select the language. For languages which are only shown as a code, please refer to 'Language Code List' on page 50.

List of Languages

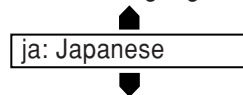

If you select "Code", use the cursor buttons (▲/▼) to input the numbers of the input code.

Use the cursor buttons (◀/▶) to change the position of the cursor. You can also use the number buttons to enter the code.

Code (0~2)

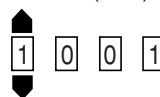

- 4 Press ENTER to set the new language. To exit the screen without making any changes, press RETURN.

# Adjusting Audio and Video Settings

## Language Code List

Language codes are used when setting the audio and subtitle language preferences (page 47, 48).

Language	Input-code
Japanese (ja)	1001
English (en)	0514
French (fr)	0618
German (de)	0405
Italian (it)	0920
Spanish (es)	0519
Chinese (zh)	2608
Dutch (nl)	1412
Portuguese (pt)	1620
Swedish (sv)	1922
Russian (ru)	1821
Korean (ko)	1115
Greek (el)	0512
Afar (aa)	0101
Abkhazian (ab)	0102
Afrikaans (af)	0106
Amharic (am)	0113
Arabic (ar)	0118
Assamese (as)	0119
Aymara (ay)	0125
Azerbaijani (az)	0126
Bashkir (ba)	0201
Byelorussian (be)	0205
Bulgarian (bg)	0207
Bihari (bh)	0208
Bislama (bi)	0209
Bengali (bn)	0214
Tibetan (bo)	0215
Breton (br)	0218
Catalan (ca)	0301
Corsican (co)	0315
Czech (cs)	0319
Welsh (cy)	0325
Danish (da)	0401
Bhutani (dz)	0426
Esperanto (eo)	0515
Estonian (et)	0520
Basque (eu)	0521
Persian (fa)	0601
Finnish (fi)	0609
Fiji (fj)	0610
Faroese (fo)	0615
Frisian (fy)	0625
Irish (ga)	0701
Scots-Gaelic (gd)	0704
Galician (gl)	0712
Guarani (gn)	0714

Language	Input-code
Gujarati (gu)	0721
Hausa (ha)	0801
Hindi (hi)	0809
Croatian (hr)	0818
Hungarian (hu)	0821
Armenian (hy)	0825
Interlingua (ia)	0901
Interlingue (ie)	0905
Inupiak (ik)	0911
Indonesian (in)	0914
Icelandic (is)	0919
Hebrew (iw)	0923
Yiddish (ji)	1009
Javanese (jw)	1023
Georgian (ka)	1101
Kazakh (kk)	1111
Greenlandic (kl)	1112
Cambodian (km)	1113
Kannada (kn)	1114
Kashmiri (ks)	1119
Kurdish (ku)	1121
Kirghiz (ky)	1125
Latin (la)	1201
Lingala (ln)	1214
Laothian (lo)	1215
Lithuanian (lt)	1220
Latvian (lv)	1222
Malagasy (mg)	1307
Maori (mi)	1309
Macedonian (mk)	1311
Malayalam (ml)	1312
Mongolian (mn)	1314
Moldavian (mo)	1315
Marathi (mr)	1318
Malay (ms)	1319
Maltese (mt)	1320
Burmese (my)	1325
Nauru (na)	1401
Nepali (ne)	1405
Norwegian (no)	1415
Occitan (oc)	1503
Oromo (om)	1513
Oriya (or)	1518
Panjabi (pa)	1601
Polish (pl)	1612
Pashto, Pushto (ps)	1619
Quechua (qu)	1721

Language	Input-code
Rhaeto-Romance (rm)	1813
Kirundi (rn)	1814
Romanian (ro)	1815
Kinyarwanda (rw)	1823
Sanskrit (sa)	1901
Sindhi (sd)	1904
Sangho (sg)	1907
Serbo-Croatian (sh)	1908
Sinhalese (si)	1909
Slovak (sk)	1911
Slovenian (sl)	1912
Samoan (sm)	1913
Shona (sn)	1914
Somali (so)	1915
Albanian (sq)	1917
Serbian (sr)	1918
Siswati (ss)	1919
Sesotho (st)	1920
Sundanese (su)	1921
Swahili (sw)	1923
Tamil (ta)	2001
Telugu (te)	2005
Tajik (tg)	2007
Thai (th)	2008
Tigrinya (ti)	2009
Turkmen (tk)	2011
Tagalog (tl)	2012
Setswana (tn)	2014
Tonga (to)	2015
Turkish (tr)	2018
Tsonga (ts)	2019
Tatar (tt)	2020
Twi (tw)	2023
Ukrainian (uk)	2111
Urdu (ur)	2118
Uzbek (uz)	2126
Vietnamese (vi)	2209
Volapük (vo)	2215
Wolof (wo)	2315
Xhosa (xh)	2408
Yoruba (yo)	2515
Zulu (zu)	2621

## Setting the Parental Lock Level

This player lets you set the Parental Lock if the DVD has a parental lock level recorded on it. With Parental Lock capable discs, you can block access to material you feel is inappropriate for your children. Refer to the DVD disc jacket and the accompanying documentation to see if a particular disc contains a parental lock level.

Make changes to the [Parental Lock] setting in the Setup screen General menu. Please note that changes to the Parental Lock level cannot be made when a disc is playing. Stop playback of the disc before attempting to make any changes.

You cannot select [Level] or [Country Code] until you have registered a password. Select [Password] to register a new password. See 'Entering the password' on the this page for how to register a new password.

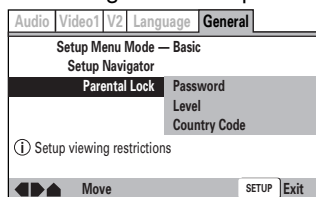

### Settings: Password

(For information, refer to 'Entering the Password' on the this page.)

### Level

(For information, refer to 'Setting the Parental Lock Level' on the following page.)

### Country Code

(For information, refer to 'Setting the Country Code' on the following page.)

### When a DVD with a set Parental Lock level is loaded

Playback cannot be started until the code number has been correctly input by using the cursor buttons (◀/▶/▲/▼) or the number buttons, and ENTER has been pressed.

## ■ Entering the Password

When you select either [Level] or [Country Code], it is necessary to register the password (4-digit code number). You'll be asked to confirm your existing password before registering a new one. Use the following steps at any time you are asked to enter or confirm your password.

- 1 Use the cursor buttons (▲/▼) or the number buttons to select a number between 0 and 9.  
You can also use the number buttons to enter the numbers directly. When entering your password for the first time, or changing it, you will be asked to reenter your password. When using the number buttons to confirm the password, the numbers appear as asterisks, and the cursor advances automatically to the next position.

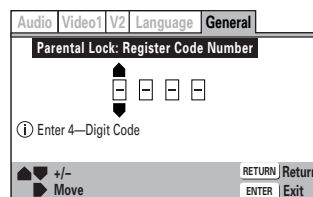

- 2 Use the cursor buttons (◀/▶) to move the cursor to a different position in the password.  
When all four numbers of the password have been entered, ENTER appears on the screen.

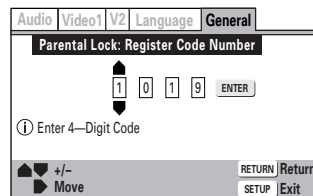

- 3 Press ENTER to set the password.  
The password is entered.

### Notes

- Be sure not to forget your password. If you should forget it, reset the system, and enter a new password. To reset the system, see 'Resetting the Player to System Settings' (page 54). Please note that this procedure resets the system, and clears all saved settings, not just the password.
- Some discs lock out violent scenes. Refer to instruction notes on discs.

# Adjusting Audio and Video Settings

## Setting the Parental Lock Level

### ■ Setting the Parental Lock Level

Change the Parental Lock level to a higher or lower level according to the settings printed on the DVD disc jacket or accompanying documentation. If you use the Condition Memory function to save the settings for a particular disc, the Parental Lock level is saved as well. Because it is saved in memory, Parental Lock levels can be set for individual discs according to their content rather than a set level for all DVDs.

- 1 Select [Level] in the [Parental Lock] setting and press ENTER.

The screen changes to the password input screen. You cannot select [Level] until you have registered a password. To enter the password, refer to 'Entering the Password' on the previous page.

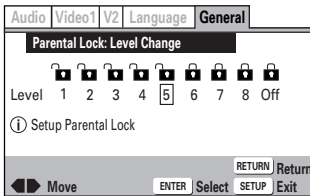

- 2 Use the cursor buttons (◀/▶) to adjust the Parental Lock Level.

The lock icons appear "unlocked" up to the selected level to indicate that access is available.

- 3 Press ENTER to set the new level.

The new Parental Lock level is set and the screen returns to the General menu screen. To go back to the General menu screen without making any changes, press RETURN.

### ■ Changing the Password

Change your password whenever you feel it is necessary. However, if you forget your existing password, you cannot enter this screen to change it.

- 1 Select [Password Change] in the [Parental Lock] setting and press ENTER.

The screen changes to the password input screen. To enter the password, refer to 'Entering the Password' on the previous page.

- 2 Use the cursor buttons (◀/▶/▲/▼) or the number buttons to enter the new password.

- 3 When the new password has been entered, press ENTER.

The new password is set and the screen returns to the General menu screen. To go back to the General menu screen without making any changes, press RETURN.

### ■ Setting the Country Code

Change your Country Code whenever you feel it is necessary. However, if you forget your existing password, you cannot enter this screen to change it.

- 1 Select [Country Code] in the [Parental Lock] setting and press ENTER.

The screen changes to the password input screen. To enter the password, refer to 'Entering the Password' on the previous page. The Country Code selection screen appear.

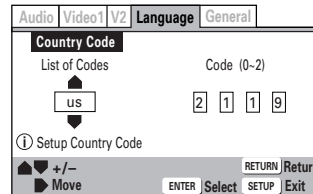

- 2 Use the cursor buttons (◀/▶) to select either "List of Codes" or "Code".

- 3 If you select "List of Codes", use the cursor buttons (▲/▼) to select the country.

For country codes which are only shown as a code, please refer to 'Country Code List' on page 53.

List of Codes



If you select "Code", use the cursor buttons (▲/▼) to input the numbers of the input code.

Use the cursor buttons (◀/▶) to change the position of the cursor. You can also use the number buttons to enter the code.

Code (0~2)

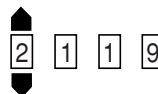

- 4 Press ENTER to set the new Country Code.

To exit the screen without making any changes, press RETURN.

## Country Code List

Country	Input-code	Country-code
ARGENTINA	0118	ar
AUSTRALIA	0121	au
AUSTRIA	0120	at
BELGIUM	0205	be
BRAZIL	0218	br
CANADA	0301	ca
CHILE	0312	cl
CHINA	0314	cn
DENMARK	0411	dk
FINLAND	0609	fi
FRANCE	0618	fr
GERMANY	0405	de
HONG KONG	0811	hk
INDIA	0914	in
INDONESIA	0904	id
ITALY	0920	it
JAPAN	1016	jp
KOREA, REPUBLIC OF	1118	kr
MALAYSIA	1325	my
MEXICO	1324	mx
NETHERLANDS	1412	nl
NEW ZEALAND	1426	nz
NORWAY	1415	no
PAKISTAN	1611	pk
PHILIPPINES	1608	ph
PORTUGAL	1620	pt
RUSSIAN FEDERATION	1821	ru
SINGAPORE	1907	sg
SPAIN	0519	es
SWEDEN	1905	se
SWITZERLAND	0308	ch
TAIWAN, PROVINCE OF CHINA	2023	tw
THAILAND	2008	th
UNITED KINGDOM	0702	gb
UNITED STATES OF AMERICA	2119	us

# Adjusting Audio and Video Settings

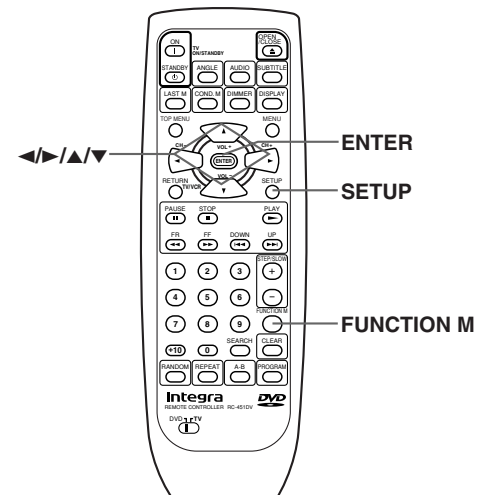

## Memorizing settings (Function Memory)

Up to 5 settings can be memorized.

<b>1</b>		<p><b>Press SETUP.</b> The Setup screen appears.</p>
<b>2</b>		<p><b>Use the cursor buttons (◀/▶) to select the menu you want.</b></p>
<b>3</b>		<p><b>Use the cursor buttons (▲/▼) to select the setting to be memorized.</b> As each menu is selected with the cursor, the settings appear below the menu heading.</p>
<b>4</b>		<p><b>Press FUNCTION M.</b> "FM" will appear on the screen, and the setting will be memorized.</p>

### ■ To clear the Function Memory

Press FUNCTION M. again

#### Note

Some settings cannot be memorized.

## Recalling memorized settings

<b>1</b>		<p><b>Press FUNCTION M.</b> Only memorized settings are displayed.</p>
<b>2</b>		<p><b>Use the cursor buttons (▲/▼) to select the menu to be recalled.</b></p>
<b>3</b>		<p><b>Press ENTER.</b></p>

## Resetting the Player to System Settings

To reset the player, press and hold Stop on the front panel when pressing Standby/On to turn the unit from standby to on .





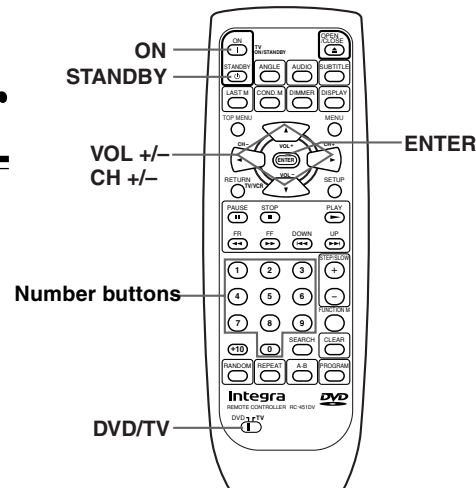



All program memory, saved settings from functions such as Video Memory, Last Memory and Condition Memory are cleared, TV System is reset to AUTO and all Setup screen menus are returned to factory settings.

# Pre-programming remote controller





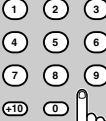

## Learning a pre-programming code

You can make RC-451DV remote controller to operate a TV from other brand than Integra/Onkyo by storing the pre-programming code of the brand in the RC-451DV.

<b>1</b>  	<b>Set the DVD/TV switch to TV.</b>
<b>2</b>	<b>Find the 2-digit number for the brand name of the component that you want to operate in the table on page 56.</b>
<b>3</b>	<b>Turn on the TV that you want to operate.</b>
<b>4</b>    	<b>While holding down the STANDBY button on the RC-451DV that you want to program, press the ENTER button, and then release both buttons.</b>
<b>5</b>  	<b>Within 30 seconds, enter the 2-digit code number.</b>
<b>6</b>	<b>Press some operation buttons for the component that you want to operate to check if the system operates properly.</b>  If the system operates properly, the code is correct. If the component does not operate properly, return to step 3.

## Controlling a TV

<b>1</b>  	<b>Set the DVD/TV switch to TV.</b>
<b>2</b>  	<b>Press the ON button to turn on the device.</b>
<b>3</b>	<b>Press the desired operation button.</b>  CH+ : Changes the TV channel upward.  CH- : Changes the TV channel downward.  TV VOL+ : Increases the TV volume. TV VOL- : Decrease the TV volume. TV/VCR : Switches the TV/VCR inputs.

### Notes

- With some brand's components, some buttons may not work correctly.
- If more than one code is given in the table, try the code one by one until you reach the code for your component (i.e. if the first code does not work, then try the next).
- The code can be retained by changing the batteries within 1 minute. If the code is lost, store the pre-programming code again.

# Pre-programming remote controller



## Pre-programming Code List

Brand	Code
ADMIRAL	01-03
AOC	04
BELL & HOWELL	01, 02
BROKSONIC	04
CRAIG	05-08
CROSLEX	09
CURTIS MATHIS	04, 08, 10
DAEWOO	04, 11, 12
DAYTRON	13
EMERSON	04-08, 13, 14
FISHER	15
GE	03, 04, 16-18
GOLDSTAR	04, 13, 19
HITACHI	04, 13, 20, 21
JC PENNEY	03, 04, 17, 19
JVC	22
KTV	04, 08, 13
LXI	03, 09, 10, 15
MAGNAVOX	04, 09, 13
MITSUBISHI	04, 23
NEC	04
PANASONIC	16-18, 24
PHILCO	04, 09, 13
PHILIPS	09
PIONEER	10, 18, 25
PORTLAND	04, 26
PROSCAN	03
QUASAR	17, 18
RADIO SHACK	03, 04, 08, 23
RCA	03, 04, 17, 26-28
SAMSUNG	04, 13, 29
SANYO	15
SCOTT	04, 08
SHARP	02, 13, 14
SIGNATURE 2000	01, 02
SONY	30
SYLVANIA	04, 09
SYMPHONIC	08
TOSHIBA	02, 10
VIDTECH	04, 20
WARDS	04, 13, 14
YAMAHA	02, 23
ZENITH	01, 31



# Troubleshooting

Check the following guide for the possible cause of a problem before contacting service. Refer also to the respective instruction manuals of the connected components and TV.

	Symptoms	Causes	Remedies	Pages
DVD Player	The DVD Player doesn't switch on.	<ul style="list-style-type: none"> <li>The mains lead is disconnected.</li> <li>The main power is set to OFF.</li> <li>There is external noise in the computer circuits of the DVD Player.</li> </ul>	<ul style="list-style-type: none"> <li>Check the connection of the mains lead.</li> <li>Turn on the main power.</li> <li>Switch off the main power, then switch it on again. If not recovered, disconnect the mains lead, then connect it again.</li> </ul>	15 15 –
	The disc tray comes back out automatically, shortly after the disc tray is closed.	<ul style="list-style-type: none"> <li>The disc is not placed properly on the disc tray.</li> <li>The disc is dirty or warped.</li> <li>Region number does not conform with this unit.</li> </ul>	<ul style="list-style-type: none"> <li>Use the disc tray guide to align the disc.</li> <li>Refer to 'Notes on Discs'.</li> <li>If the region number on the disc does not match the number on the player, the disc cannot be used</li> </ul>	19 5 4
	The DVD Player does not start playback.	<ul style="list-style-type: none"> <li>No disc is inserted.</li> <li>An unplayable disc is inserted.</li> <li>The disc is placed upside down.</li> <li>The disc is not placed within the disc tray guide.</li> <li>The disc is dirty.</li> <li>The parental lock function is activated.</li> </ul>	<ul style="list-style-type: none"> <li>Insert a disc. (Check that "DVD," "VCD," or "CD" is lit in the DVD Player's display.)</li> <li>Check the playable discs.</li> <li>Place the disc with the playback side down.</li> <li>Place the disc within the proper guide on the disc tray.</li> <li>Eject the disc and clean it.</li> <li>Deactivate the parental lock function or change the parental lock level.</li> </ul>	19 5 19 19 6 51-53
	The playback picture is occasionally distorted.	<ul style="list-style-type: none"> <li>The disc is dirty.</li> <li>It is in fast forward or fast reverse playback.</li> </ul>	<ul style="list-style-type: none"> <li>Eject the disc and clean it.</li> <li>Sometimes a small amount of picture distortion may appear. This is not a malfunction.</li> </ul>	6 –
	Brightness is unstable or noise is visible on the playback picture.	<ul style="list-style-type: none"> <li>Copy protection is activated.</li> </ul>	<ul style="list-style-type: none"> <li>Connect the DVD Player directly to the TV. Avoid connecting the DVD Player to the TV through a VCR.</li> </ul>	13
	The picture from the DVD Player doesn't appear on the TV screen.	<ul style="list-style-type: none"> <li>The TV is not set to receive the output signals from the DVD Player.</li> <li>The DVD Player is not properly connected.</li> </ul>	<ul style="list-style-type: none"> <li>Set the TV to the DVD Player's input.</li> <li>Check the connections to the DVD Player.</li> </ul>	– 13
	Settings are canceled.	<ul style="list-style-type: none"> <li>When the power is turned off by power failure or by unplugging the power cord, settings will be canceled.</li> </ul>	<ul style="list-style-type: none"> <li>Before unplugging the power cord, press STANDBY/ON and check that "--OFF--" disappears in the display.</li> </ul>	–
	Playback doesn't follow the course of the disc's programs.	<ul style="list-style-type: none"> <li>The DVD Player is in repeat playback mode, memory playback mode, or random playback mode, etc.</li> </ul>	<ul style="list-style-type: none"> <li>Resume normal playback.</li> </ul>	26-31
	The buttons on the remote controller and DVD Player do not operate.	<ul style="list-style-type: none"> <li>Power supply fluctuations or other abnormalities such as static electricity may interrupt correct operation.</li> </ul>	<ul style="list-style-type: none"> <li>Switch off the main power, then switch it on again. If not recovered, disconnect the mains lead, then connect it again.</li> </ul>	15
	 mark appears on screen.	<ul style="list-style-type: none"> <li>The selected function does not operate for that disc.</li> </ul>	–	–
	 mark appears on screen.	<ul style="list-style-type: none"> <li>The operation is prohibited by the player.</li> </ul>	–	–
	When making changes in the Setup screen menus,  is displayed.	<ul style="list-style-type: none"> <li>There is a Video CD, CD or MP3 loaded in the player and the setting that was changed only applies to DVD performance.</li> </ul>	<ul style="list-style-type: none"> <li>The setting will be effective the next time a DVD is loaded.</li> </ul>	39
	Some settings in the Setup Menu do not appear.	<ul style="list-style-type: none"> <li>The [Setup Menu Mode] is set to [Basic].</li> </ul>	Set the [Setup Menu Mode] to [Expert].	39

# Troubleshooting

	Symptoms	Causes	Remedies	Pages
DVD Player	No sound is reproduced.	<ul style="list-style-type: none"> <li>The Setup screen Audio menu [96 kHz PCM Out] setting is set to [96 kHz].</li> <li>The Setup screen Audio menu [Digital Out] is set to [Off].</li> <li>A wrong sound signal conversion method is selected.</li> <li>The pause mode is engaged.</li> <li>The volume level of TV or amplifier is set to minimum.</li> <li>The DVD or CD is recorded in DTS audio.</li> </ul>	<ul style="list-style-type: none"> <li>Either connect using the analog outputs, or set [96kHz PCM Out] in the Audio menu to [96kHz ▶ 48 kHz].</li> <li>Set [Digital Out] to [On].</li> <li>Check the current sound signal conversion method, and select the right setting.</li> <li>Press ▶ or    to exit the pause mode.</li> <li>Increase the volume level.</li> <li>DTS audio is only output from the digital output jacks. Connect the digital output on the player to the digital input on a receiver or amplifier with a built in DTS decoder to hear DTS audio.</li> </ul>	<p>41</p> <p>41</p> <p>40, 41</p> <p>23</p> <p>–</p> <p>14</p>
	The screen is stretched or aspect does not change.	<ul style="list-style-type: none"> <li>The multi aspect setting is not appropriate.</li> <li>The TV is connected with an S-video cord.</li> </ul>	<ul style="list-style-type: none"> <li>Change the aspect setting in the [TV Screen] setting in the Setup screen Video 1 menu to the screen type most appropriate to the TV or monitor you are using.</li> <li>If you connected your TV with an S-Video cord, in rare cases the TV picture may appear stretched. In this case switch the output from [S2] to [S1]</li> </ul>	<p>42</p> <p>43</p>
	Some MP3 tracks appear to be missing from a disc.	<ul style="list-style-type: none"> <li>The track name does not end in ".mp3" or ".MP3".</li> <li>More than 251 folders and tracks are recorded on a disc.</li> <li>A multi-session disc is inserted.</li> </ul>	<ul style="list-style-type: none"> <li>This system will not recognize file that does not end in ".mp3" or ".MP3" as an MP3 track. Change the track name.</li> <li>This player only recognizes the first 250 folders and tracks on a disc. If there are more folders/tracks than this, you will not be able to play them.</li> <li>This player is not compatible with multi-session discs. If the disc is multi-session, you will only be able to play tracks recorded onto the first session.</li> </ul>	<p>5</p> <p>5</p> <p>5</p>
Remote Controller	The buttons on the DVD Player operates but the buttons on the remote controller do not operate.	<ul style="list-style-type: none"> <li>No batteries are inserted in the remote controller.</li> <li>The batteries are worn out.</li> <li>The remote controller is not pointed at the remote sensor of the DVD Player.</li> <li>The remote controller is too far from the DVD Player</li> </ul>	<ul style="list-style-type: none"> <li>Insert new batteries.</li> <li>Replace with new batteries.</li> <li>Point the remote controller at the remote sensor of the DVD Player.</li> <li>Operate the remote controller within 5 m</li> </ul>	<p>9</p> <p>9</p> <p>9</p> <p>9</p>

Because the unit contains a microcomputer to provide advanced functions, it may malfunction due to external noise or static electricity. If this happens, press the Power switch on the unit and then press it again after about five seconds.

# Specifications

## ■ DVD Player

Power supply	AC 120 V, 60 Hz
Power consumption	14 W
Power consumption (standby mode)	1.4 W
Weight	3.4 kg, 7.5 lbs.
External dimensions	435 × 91 × 312 mm (W/H/D), 17-1/8" × 3-9/16" × 12-5/16"
Signal system	Standard NTSC
Regional restriction code	1
Laser	Semiconductor laser, wavelength 650 nm
Frequency range (digital audio)	DVD linear sound: 48 kHz sampling 4 Hz to 22 kHz 96 kHz sampling 4 Hz to 44 kHz Audio CD: 4 Hz to 20 kHz
Signal-to-noise ratio (digital audio)	More than 100 dB
Audio dynamic range (digital audio)	More than 96 dB
Harmonic distortion (digital audio)	Less than 0.015 %
Wow and flutter	Below measurable level (less than ±0.001 % (W.PEAK))
Operating conditions	Temperature: 5°C to 35°C (41°F to 95°F), Operation status: Horizontal

## ■ Outputs

Video output	1.0 V (p-p), 75 Ω, negative sync., pin jack × 1
S-video output	(Y) 1.0 V (p-p), 75 Ω, negative sync., Mini DIN 4-pin × 1 (C) 0.286 V (p-p), 75 Ω
Component video output	(Y) 1.0 V (p-p), 75 Ω, negative sync., pin jack × 1 (P <sub>B</sub> )/(P <sub>R</sub> ) 0.7 V (p-p), 75 Ω
Audio output (digital output Optical)	-22.5 dBm × 1
Audio output (digital output Coaxial)	0.5 V (p-p), 75 Ω, pin jack × 1
Audio output (analog audio)	2.0 V (rms), 470 Ω, pin jack (L, R) × 2
Audio output (Mono)	2.0 V (rms), 470 Ω, pin jack × 1

---

Integra Division of  
**ONKYO U.S.A. CORPORATION**  
18 park Way, Upper Saddle River, N.J. 07458, U.S.A.  
Tel: 201-785-2600 Fax: 201-785-2650 <http://www.integrahometheater.com>

Integra Division of  
**ONKYO CORPORATION**  
Sales & Product Planning Div. : 2-1, Nisshin-cho, Neyagawa-shi, OSAKA 572-8540, JAPAN  
Tel: 072-831-8111 Fax: 072-833-5222

## Free Manuals Download Website

<http://myh66.com>

<http://usermanuals.us>

<http://www.somanuals.com>

<http://www.4manuals.cc>

<http://www.manual-lib.com>

<http://www.404manual.com>

<http://www.luxmanual.com>

<http://aubethermostatmanual.com>

Golf course search by state

<http://golfingnear.com>

Email search by domain

<http://emailbydomain.com>

Auto manuals search

<http://auto.somanuals.com>

TV manuals search

<http://tv.somanuals.com>