

Integra

DVD AUDIO/VIDEO Player

DPS-9.1

Instruction Manual

Thank you for purchasing the **Integra** DVD AUDIO/VIDEO Player.

Please read this manual thoroughly before making connections and turning on the power.

Following the instructions in this manual will enable you to obtain optimum performance and listening enjoyment from your new Player. Please retain this manual for future reference.



Contents

Before Using Your DVD Player 2

Getting Started 8

Basic Playback 20

Advanced Playback 27

Quick Control and Performance Options 36

Function Setup 44

Remote Controller 56

Others 61

WARNING:

TO REDUCE THE RISK OF FIRE OR ELECTRIC SHOCK, DO NOT EXPOSE THIS APPLIANCE TO RAIN OR MOISTURE.

CAUTION:

TO REDUCE THE RISK OF ELECTRIC SHOCK, DO NOT REMOVE COVER (OR BACK). NO USER-SERVICEABLE PARTS INSIDE. REFER SERVICING TO QUALIFIED SERVICE PERSONNEL.



WARNING
RISK OF ELECTRIC SHOCK
DO NOT OPEN

AVIS
RISQUE DE CHOC ELECTRIQUE
NE PAS OUVRIR



The lightning flash with arrowhead symbol, within an equilateral triangle, is intended to alert the user to the presence of uninsulated "dangerous voltage" within the product's enclosure that may be of sufficient magnitude to constitute a risk of electric shock to persons.



The exclamation point within an equilateral triangle is intended to alert the user to the presence of important operating and maintenance (servicing) instructions in the literature accompanying the appliance.

Important Safeguards

- 1. Read Instructions** – All the safety and operating instructions should be read before the appliance is operated.
- 2. Retain Instructions** – The safety and operating instructions should be retained for future reference.
- 3. Heed Warnings** – All warnings on the appliance and in the operating instructions should be adhered to.
- 4. Follow Instructions** – All operating and use instructions should be followed.
- 5. Cleaning** – Unplug the appliance from the wall outlet before cleaning. The appliance should be cleaned only as recommended by the manufacturer.
- 6. Attachments** – Do not use attachments not recommended by the appliance manufacturer as they may cause hazards.
- 7. Water and Moisture** – Do not use the appliance near water –for example, near a bath tub, wash bowl, kitchen sink, or laundry tub; in a wet basement; or near a swimming pool; and the like.
- 8. Accessories** – Do not place the appliance on an unstable cart, stand, tripod, bracket, or table. The appliance may fall, causing serious injury to a child or adult, and serious damage to the appliance. Use only with a cart, stand, tripod, bracket, or table recommended by the manufacturer, or sold with the appliance. Any mounting of the appliance should follow the manufacturer's instructions, and should use a mounting accessory recommended by the manufacturer.
- 9. An appliance and cart combination should be moved with care. Quick stops, excessive force, and uneven surfaces may cause the appliance and cart combination to overturn.**

PORTABLE CART WARNING



S3125A
- 10. Ventilation** – Slots and openings in the cabinet are provided for ventilation and to ensure reliable operation of the appliance and to protect it from overheating, and these openings must not be blocked or covered. The openings should never be blocked by placing the appliance on a bed, sofa, rug, or other similar surface. The appliance should not be placed in a built-in installation such as a bookcase or rack unless proper ventilation is provided. There should be free space of at least 5 cm (2 in.) and an opening behind the appliance.
- 11. Power Sources** – The appliance should be operated only from the type of power source indicated on the marking label. If you are not sure of the type of power supply to your home, consult your appliance dealer or local power company.
- 12. Grounding or Polarization** – The appliance may be equipped with a polarized alternating current line plug (a plug having one blade wider than the other). This plug will fit into the power outlet only one way. This is a safety feature. If you are unable to insert the plug fully into the outlet, try reversing the plug. If the plug should still fail to fit, contact your electrician to replace your obsolete outlet. Do not defeat the safety purpose of the polarized plug.
- 13. Power-Cord Protection** – Power-supply cords should be routed so that they are not likely to be walked on or pinched by items placed upon or against them, paying particular attention to cords at plugs, convenience receptacles, and the point where they exit from the appliance.
- 14. Lightning** – For added protection for the appliance during a lightning storm, or when it is left unattended and unused for long periods of time, unplug it from the wall outlet and disconnect the antenna or cable system. This will prevent damage to the appliance due to lightning and power-line surges.
- 15. Overloading** – Do not overload wall outlets, extension cords, or integral convenience receptacles as this can result in a risk of fire or electric shock.
- 16. Object and Liquid Entry** – Never push objects of any kind into the appliance through openings as they may touch dangerous voltage points or short-out parts that could result in a fire or electric shock. Never spill liquid of any kind on the appliance.
- 17. Servicing** – Do not attempt to service the appliance yourself as opening or removing covers may expose you to dangerous voltage or other hazards. Refer all servicing to qualified service personnel.
- 18. Damage Requiring Service** – Unplug the appliance from the wall outlet and refer servicing to qualified service personnel under the following conditions:
 - When the power-supply cord or plug is damaged,
 - If liquid has been spilled, or objects have fallen into the appliance,
 - If the appliance has been exposed to rain or water,
 - If the appliance does not operate normally by following the operating instructions. Adjust only those controls that are covered by the operating instructions as an improper adjustment of other controls may result in damage and will often require extensive work by a qualified technician to restore the appliance to its normal operation,
 - If the appliance has been dropped or damaged in any way, and
 - When the appliance exhibits a distinct change in performance – this indicates a need for service.
- 19. Replacement Parts** – When replacement parts are required, be sure the service technician has used replacement parts specified by the manufacturer or have the same characteristics as the original part. Unauthorized substitutions may result in fire, electric shock, or other hazards.
- 20. Safety Check** – Upon completion of any service or repairs to the appliance, ask the service technician to perform safety checks to determine that the appliance is in proper operation condition.
- 21. Wall or Ceiling Mounting** – The appliance should be mounted to a wall or ceiling only as recommended by the manufacturer.
- 22. Heat** – The appliance should be situated away from heat sources such as radiators, heat registers, stoves, or other appliances (including amplifiers) that produce heat.

Precautions

This unit contains a semiconductor laser system and is classified as a "CLASS 1 LASER PRODUCT". So, to use this model properly, read this Instruction Manual carefully. In case of any trouble, please contact the store where you purchased the unit. To prevent being exposed to the laser beam, do not try to open the enclosure.

CAUTION:

VISIBLE LASER RADIATION WHEN OPEN AND INTERLOCK FAILED OR DEFEATED. DO NOT STARE INTO BEAM.

CAUTION:

THIS PRODUCT UTILIZES A LASER. USE OF CONTROLS OR ADJUSTMENTS OR PERFORMANCE OF PROCEDURES OTHER THAN THOSE SPECIFIED HEREIN MAY RESULT IN HAZARDOUS RADIATION EXPOSURE.

The label on the right is applied on the rear panel except for USA and Canadian models.

**"CLASS 1 LASER
PRODUCT"**

1. This unit is a CLASS 1 LASER PRODUCT and employs a laser inside the cabinet.
2. To prevent the laser from being exposed, do not remove the cover. Refer servicing to qualified personnel.

For U.S. model

The laser is covered by a housing which prevents exposure during operation or maintenance. However, this product is classified as a Laser Product by CDRH (Center for Devices and Radiological Health) which is a department of the Food and Drug Administration. According to their regulations 21 CFR section 1002.30, all manufactures who sell Laser Products must maintain records of written communications between the manufacturer, dealers and customers concerning radiation safety. If you have any complaints about instructions or explanations affecting the use of this product, please feel free to write to the address on the back page of this manual. When you write us, please include the model number and serial number of your unit.

In compliance with Federal Regulations, the certification, identification and the period of manufacture are indicated on the rear panel.

FCC INFORMATION FOR USER

CAUTION:

The user changes or modifications not expressly approved by the party responsible for compliance could void the user's authority to operate the equipment.

NOTE:

This equipment has been tested and found to comply with the limits for a Class B digital device, pursuant to Part 15 of the FCC Rules. These limits are designed to provide reasonable protection against harmful interference in a residential installation. This equipment generates, uses and can radiate radio frequency energy and, if not installed and used in accordance with the instructions, may cause harmful interference to radio communications. However, there is no guarantee that interference will not occur in a particular installation. If this equipment does cause harmful interference to radio or television reception, which can be determined by turning the equipment off and on, the user is encouraged to try to correct the interference by one or more of the following measures:

- Reorient or relocate the receiving antenna.
- Increase the separation between the equipment and receiver.
- Connect the equipment into an outlet on a circuit different from that to which the receiver is connected.
- Consult the dealer or an experienced radio/TV technician for help.

For Canadian model

This class B digital apparatus complies with Canadian ICES-003.

For models having a power cord with a polarized plug:

CAUTION: TO PREVENT ELECTRIC SHOCK, MATCH WIDE BLADE OF PLUG TO WIDE SLOT, FULLY INSERT.

Modele pour les Canadien

Cet appareil numérique de la classe B est conforme à la norme NMB-003 du Canada.

Sur les modeles dont la fiche est polarisee:

ATTENTION: POUR EVITER LES CHOCS ELECTRIQUES, INTRODUIRE LA LAME LA PLUS LARGE DE LA FICHE DANS LA BORNE CORRESPONDANTE DE LA PRISE ET POUSSER JUSQU'AU FOND.

Precautions

1. Regional Restriction Codes (Region Number)

Regional restriction codes are built into DVD Players and DVD-Video media for each sales region. If the regional code of the DVD Player does not match one of the regional codes on the DVD-Video, playback is not possible.

The regional number can be found on the rear panel of the DVD

Player. (e.g.  for Region 1)

2. About This Manual

This manual explains the basic procedures for operating the DVD Player. Some DVD-Video and DVD-Audio discs do not support the full potential of the DVD technology. Your DVD Player may therefore not respond to all operating commands. Refer to instruction notes on discs.

A “” mark may appear on the TV screen during operation. It means that the operation is not permitted by the DVD Player or the disc.

3. Warranty Claim

You can find the serial number on the rear panel of the unit. In case of warranty claim, please report this number.

4. Recording Copyright

Recording of copyrighted material for other than personal use is illegal without permission of the copyright holder.

5. Power

WARNING

BEFORE PLUGGING IN THE UNIT FOR THE FIRST TIME, READ THE FOLLOWING SECTION CAREFULLY.

The voltage of the available power supply differs according to country or region. Be sure that the power supply voltage of the area where the unit will be used meets the required voltage (e.g., AC 120 V, 60 Hz) written on the rear panel.

6. Do not touch the unit with wet hands

Do not handle the unit or power cord when your hands are wet or damp. If water or any other liquid enters the case, take the unit to an authorized service center for inspection.

7. Location of the unit

- Place the unit in a well-ventilated location.
Take special care to provide plenty of ventilation on all sides of the unit especially when it is placed in an audio rack. If ventilation is blocked, the unit may overheat and malfunction.
- Do not expose the unit to direct sunlight or heating units as the unit's internal temperature may rise and shorten the life of the pickup.
- Avoid damp and dusty places and places directly affected by vibrations from the speakers. In particular, avoid placing the unit on or above one of the speakers.
- Be sure the unit is placed in a horizontal position. Never place it on its side or on a slanted surface as it may malfunction.
- When you place the unit near a TV, radio, or VCR, the playback picture may become poor and the sound may be distorted. In this case, place the unit away from the TV, radio, or VCR.

8. Care

From time to time you should wipe the front and rear panels and the cabinet with a soft cloth. For heavier dirt, dampen a soft cloth in a weak solution of mild detergent and water, wring it out dry, and wipe off the dirt. Following this, dry immediately with a clean cloth.

Do not use rough material, thinners, alcohol or other chemical solvents or cloths since these could damage the finish or remove the panel lettering.

9. Notes on Handling

- When shipping the unit, use the original shipping carton and packing materials. For maximum protection, repack the unit as it was originally packed at the factory.
- Do not use volatile liquids, such as insect spray, near the unit. Do not leave rubber or plastic products in contact with the unit for a long time. They will leave marks on the finish.
- The top and rear panels of the unit **may become warm after a long period of use. This is not a malfunction.**
- When the unit is not in use, be sure to remove the disc and turn off the power.
- If you do not use the unit for a long period, the unit may not function properly in the future. Turn on and use the unit occasionally.

10. To Obtain a Clear Picture

The unit is a high technology, precision device. If the optical pick-up lens and disc drive parts are dirty or worn down, the picture quality becomes poor. To obtain a clear picture, we recommend regular inspection and maintenance (cleaning or parts replacement) every 1,000 hours of use depending on the operating environment. For details, contact your nearest dealer.

11. Notes on Moisture Condensation

Moisture condensation damages the unit.

Please read the following carefully.

- What is moisture condensation?**
Moisture condensation occurs, for example, when you pour a cold drink into a glass on a warm day. Drops of water form on the outside of the glass. In the same way, moisture may condense on the optical pick-up lens inside the unit, one of the most crucial internal parts of the unit.
- Moisture condensation occurs in the following cases.**
 - When you bring the unit directly from a cold place to a warm place.
 - When you use the unit in a room where you just turned on the heater, or a place where the cold wind from the air conditioner directly hits the unit.
 - In summer, when you use the unit in a hot and humid place just after you move the unit from an air conditioned room.
 - When you use the unit in a humid place.
- Do not use the unit when moisture condensation may occur.**
If you use the unit in such a situation, it may damage discs and internal parts. Remove the disc, connect the power cord of the unit to the wall outlet, turn on the unit, and leave it for two or three hours. After a few hours, the unit will have warmed up and evaporated any moisture. Keep the unit connected to the wall outlet and moisture condensation will seldom occur.

Table of Contents

Important Safeguards/Precautions/Table of Contents/Notes on Discs	2 - 6
---	-------

Getting Started

Features/Supplied Accessories	8
Preparing the Remote Controller	9
Making Connections	10
Control Position and Names	14
Connecting the Power/Turning on the DVD Player	17
Setting up the DVD Player for Optimal Performance	18

Basic Playback

Playing DVD-Video/Audio, Video CD, and CD	20
Locating a Specific Title/Group/Chapter/Track/Location	24

Advanced Playback

Playing Repeatedly	27
Playing in a Favorite Order	28
Playing in Random Order	29
Zooming a Picture	30
Improving Picture Quality	31
Selecting the Camera Angle	32
Selecting the Subtitle Language/Turning On/Off Subtitles	33
Selecting the Audio Language	34
Output Sound Conversion Table	35

Quick Control and Performance Options

Using the Graphic Remote Control - V.REMOTE	36
Selecting the Playback Function - QUICK	37
Accessing Playback Features - NAVI	38
Selecting Progressive Video Output	42
Turning Off the Video Signal Output	43

Function Setup

Customizing the Function Settings	44
Table of Languages	55

Remote Controller

Using the Remote Controller	56
Programming the Commands of Other Remote Controller Units into the Remote Controller	58

Others

Troubleshooting	61
Specifications	62

Notes on Discs

This section shows you how to handle, clean, and store discs.

Playable Discs

This DVD Player can playback the following discs.

	Disc mark	Contents	Disc size
DVD-Video		Audio + Video (moving pictures)	12 cm
			8 cm
DVD-Audio		Audio	12 cm
			8 cm
Video CD		Audio + Video (moving pictures)	12 cm
			8 cm
CD		Audio	12 cm
			8 cm (CD single)

- CD-R and CD-RW discs recorded by CD-DA method can also be played. Some CD-R/RW discs may be incompatible.
- You cannot playback discs other than those listed above.
- You cannot play discs such as CD-ROM, DVD-RAM, DVD-RW, etc., even if the marks in the above table are labeled on those discs.
- This DVD Player uses the NTSC color system, and cannot playback video media recorded in any other color system (SECAM, etc.).
- Avoid using heart-shaped or octagonal discs. Playing irregularly shaped discs may damage the internal mechanism of the DVD Player.

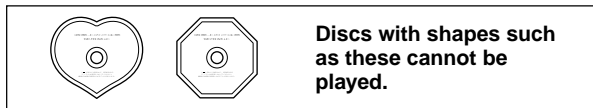

- Do not use discs that have residue from adhesive tape, rental discs that have peeling labels, or discs that have custom labels or stickers. Otherwise, you may not be able to eject the discs or the DVD Player may become inoperative.

Handling Discs

- Do not touch the playback side of the disc.

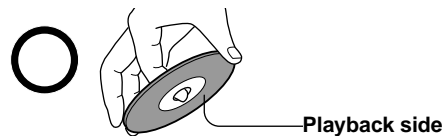

- Do not attach paper or tape to discs.



Cleaning Discs

- Fingerprints and dust on the disc cause picture and sound deterioration. Wipe the disc from the center outwards with a soft cloth. Always keep the disc clean.

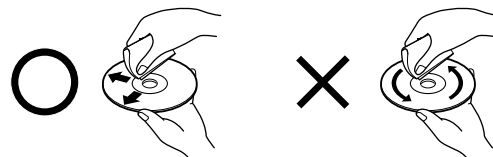

- If you cannot wipe off the dust with a soft cloth, wipe the disc lightly with a slightly moistened soft cloth and finish with a dry cloth.
- Do not use any type of solvent such as thinner, benzene, commercially available cleaners or antistatic spray for vinyl LPs. It may damage the disc.

Storing Discs

- Do not store discs in a place subject to direct sunlight or near heat sources.
- Do not store discs in places subject to moisture and dust such as a bathroom or near a humidifier.
- Store discs vertically in a case. Stacking or placing objects on discs outside of their case may cause warping.

About Video CDs

This DVD Player supports Video CDs equipped with the PBC (Version 2.0) function. (PBC is the abbreviation of Playback Control.) You can enjoy two playback variations depending on the type of disc.

- **Video CD not equipped with PBC function (Version 1.1)**
Sound and movies can be played on this DVD Player in the same way as a CD.
- **Video CD equipped with PBC function (Version 2.0)**
In addition to operation of the Video CD not equipped with the PBC function, you can enjoy playback with interactive software and search function using the menu displayed on the TV screen (Menu Playback). Some of the functions described in this Instruction Manual may not work with some discs.

Notes on Copyright

It is forbidden by law to copy, broadcast, show, broadcast on cable, play in public, and rent copyrighted material without permission. The video recorded on DVD-Video is copy protected, and any recordings made from these discs will be distorted. This product incorporates copyright protection technology that is protected by method claims of certain U.S. patents and other intellectual property rights owned by Macrovision Corporation and other rights owners. Use of this copyright protection technology must be authorized by Macrovision Corporation, and is intended for home and other limited viewing uses only unless otherwise authorized by Macrovision Corporation. Reverse engineering or disassembly is prohibited.

The Structure of the Disc Content

DVD-Video

Normally, the contents of DVD-Video are divided into titles, and the titles are subdivided into chapters.

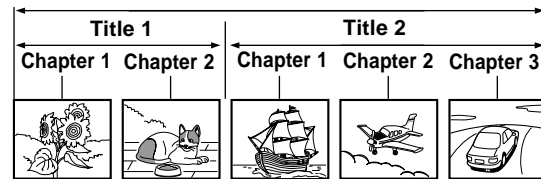

DVD-Audio

The contents of DVD-Audio are divided into groups, and the groups are subdivided into tracks.

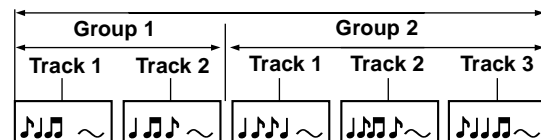

Video CD/CD

Video CD and CD are divided into tracks.



Features/Supplied Accessories

Features

- THX*¹ Ultra Certified
- Plays DVD-Audio & Video Discs, Video CDs, CD-Rs & CDs
- 54 MHz/10-bit Video DAC
- 192 kHz/24-bit DACs
- DB-25 and RCA-6ch Multichannel Outputs
- 2 Gold-Plated Progressive Component-Video Outputs
- 4 Digital Outputs pass DTS*², Dolby*³ Digital and PCM Signals
- Dolby® Digital decoder Built In
- Separate Transformers for Digital and Analog Sections
- Electrical and Magnetic Shielded Mechanism
- Heavy-Duty Mechanical Tray Door
- Full-function remote controller with “Learning” function for control of other component

*¹ Manufactured under licence from Lucasfilm Ltd. Lucasfilm and THX are registered trademarks of Lucasfilm Ltd.

*² Manufactured under license from Digital Theater Systems, Inc. US Pat. No.5,451,942 and other worldwide patents issues and pending. “DTS” and “DTS Digital Surround” are trademarks of Digital Theater Systems, Inc. ©1996 Digital Theater Systems, Inc. All Rights reserved.

*³ Manufactured under license from Dolby Laboratories. “Dolby”, “Pro Logic” and the double-D symbol are trademarks of Dolby Laboratories. Confidential Unpublished Works. ©1992-1997 Dolby Laboratories, Inc. All rights reserved.

THX Ultra

Before any home theatre component can be THX Ultra certified, it must pass a rigorous series of quality and performance tests. Only then can product feature the THX Ultra logo, which is your guarantee that the Home Theatre products you purchase will give you superb performance for many years to come.

Supplied Accessories

Make sure your box contains everything listed below.
The number of accessories is indicated in brackets [].

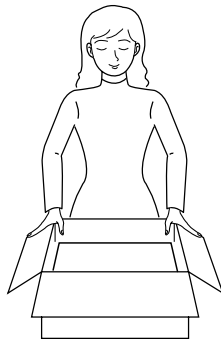

Remote controller (RC-439DV) [1]

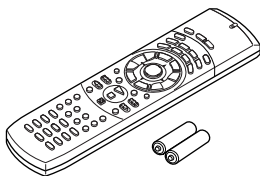

Batteries (size AA/UM-3) [2]

S-video cable [1]

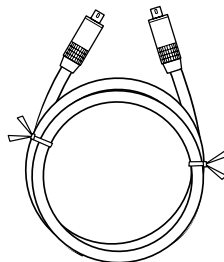

Power cord [1]

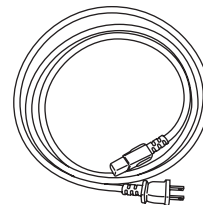

Audio/video connection cable [1]

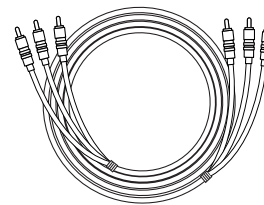

DB-25 cable [1]

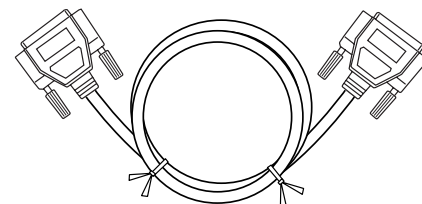

Preparing the Remote Controller

Inserting the Batteries

- 1 Open the battery compartment cover.

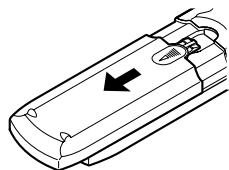

- 2 Insert the two R6 (size AA) batteries. Be sure to match the + and - ends of the batteries with the diagram inside the battery compartment.

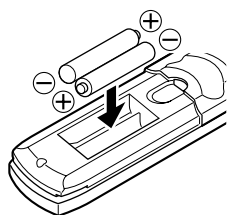

- 3 Close the battery compartment cover.

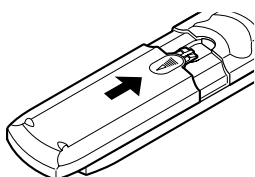

Notes

- Do not mix new batteries with old batteries or different kinds of batteries.
- To avoid corrosion, remove the batteries if the remote controller is not to be used for a long time.
- Remove dead batteries immediately to avoid damage from corrosion. If the remote controller does not operate smoothly, replace both batteries at the same time.
- The life of the batteries supplied is about six months but this will vary depending on usage.

Using the Remote Controller

Point the remote controller toward the remote control sensor.

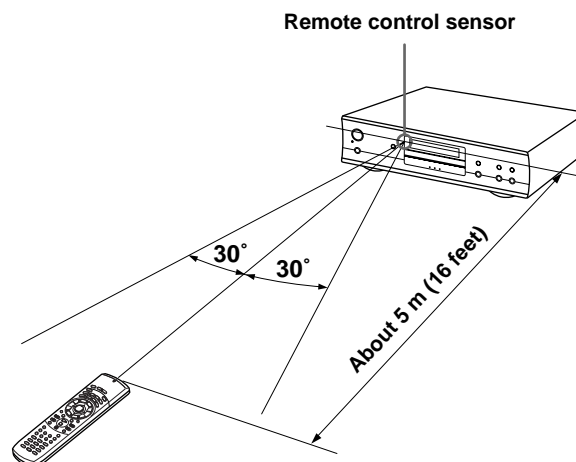

Notes

- Place the unit away from strong light such as direct sunlight or inverted fluorescent light which can prevent proper operation of the remote controller.
- Using another remote controller of the same type in the same room or using the unit near equipment which uses infrared rays may cause operational interference.
- Do not put any object such as a book on the remote controller. The buttons of the remote controller may be pressed by mistake and drain the batteries.
- Make sure the audio rack doors do not have colored glass. Placing the unit behind such doors may prevent proper remote controller operation.
- If there is any obstacle between the remote controller and the remote control sensor, the remote controller will not operate.

Making Connections

To accommodate a wide range of home entertainment systems, this player features numerous connection types for both audio and video. Please refer to the instructions on this and the following pages to determine the best possible type of connections for your system.

Before Connecting

- Refer to the instruction manuals supplied with any and all components that you plan to connect the DVD Player to.
- Be sure to turn off the power of all components to be connected and unplug them from the wall outlet before making any connections.
- Connect the DVD Player to the TV directly. If you connect the DVD Player to a VCR, TV/VCR combination, or video selector, the playback picture may be distorted as DVD Video images are copy protected.
- Please note that video connections to a TV or monitor are necessary because some discs require on-screen menu interaction before they can be played.
- Connect the plugs securely.

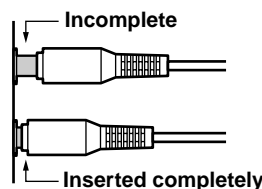

Connections to a TV

The diagram below shows how to make connections to a TV with built-in stereo speakers using the supplied audio/video cable. After making the connections on this page, you will be able to start using the DVD Player.

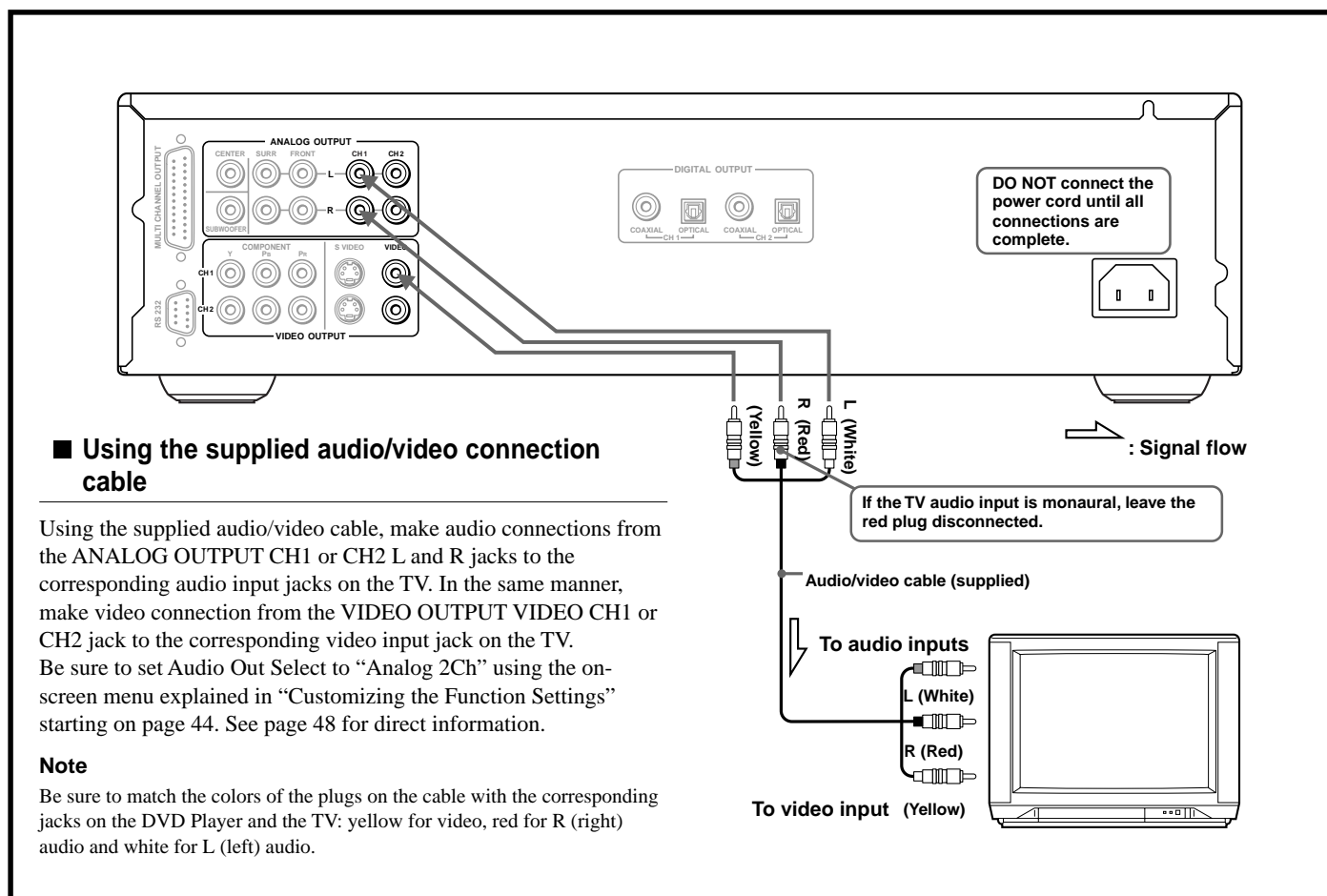

Optional Video Connections

Visible improvements in DVD-Video quality can be achieved by making either S-video or component video connections to a TV or monitor compatible with these types of connections.

Note

When either S-video or component video connection is made, it is not necessary to make composite video connections using the yellow cord of the audio-video cable.

■ Making component video connections

If the TV or monitor has component video inputs, making this type of video connection will produce the ideal picture quality for the presentation of DVD-Video. Using a component video cable (sold separately), connect the VIDEO OUTPUT COMPONENT CH1 or CH2 jacks to the corresponding component video input jacks on the TV.

Actual labels for component video inputs may vary depending on the TV manufacturer. (e.g. Y, R-Y, B-Y or Y, CB, CR)

In some TVs or monitors, the color levels of the playback picture may be reduced slightly or the tint may change. In such a case, adjust the TV or monitor for optimum performance.

Be sure to set Audio Out Select to "Analog 2Ch" using the on-screen menu explained in "Customizing the Function Settings" starting on page 44. See page 48 for direct information.

PROGRESSIVE outputs/inputs

Some TVs or monitors are equipped with component video inputs that are capable of reproducing a progressively scanned video signal. Connecting to these inputs allows you to view the highest quality pictures with less flicker.

Interlaced outputs/inputs

Some TVs or monitors are equipped with component video inputs. Connecting to these inputs allows you to enjoy higher quality picture playback.

In some TVs or monitors, the color levels of the playback picture may be reduced slightly or the tint may change. In such a case, adjust the TV or monitor for optimum performance.

To switch the output signal (Progressive/Interlaced)

Press **PROGRESSIVE** on the remote control.

The output signal alternates between component progressive and component interlaced. For details, refer to "Selecting Progressive Scan Video Output" on page 42.

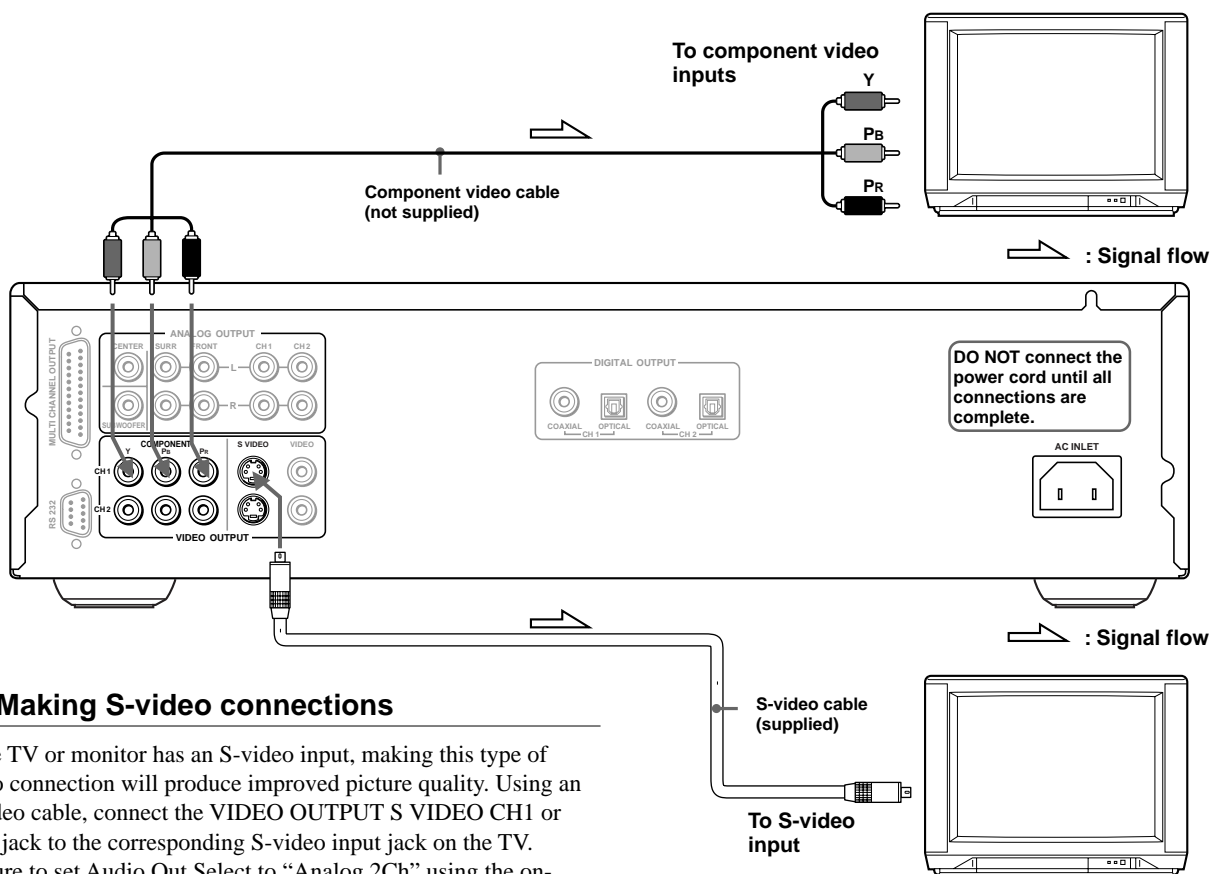

■ Making S-video connections

If the TV or monitor has an S-video input, making this type of video connection will produce improved picture quality. Using an S-video cable, connect the VIDEO OUTPUT S VIDEO CH1 or CH2 jack to the corresponding S-video input jack on the TV.

Be sure to set Audio Out Select to "Analog 2Ch" using the on-screen menu explained in "Customizing the Function Settings" starting on page 44. See page 48 for direct information.

Making Connections

Optional Audio Connections

This DVD Player provides numerous ways to take full advantage of the digital multi channel sound recorded on DVD media.

When listening to DVD-Audio

For full enjoyment of DVD-Audio media, it is recommended to make connections to the 6-channel ANALOG OUTPUT jacks. Audio output of DVD-Audio cannot be played back efficiently when output as a bitstream or PCM from the DIGITAL OUTPUT jacks.

Analog connections

In addition to offering two stereo outputs for connection to a stereo system, two types of multi channel analog output allow you to make connections to an AV component that features multi channel analog input for full enjoyment of multi channel DVD-Audio discs.

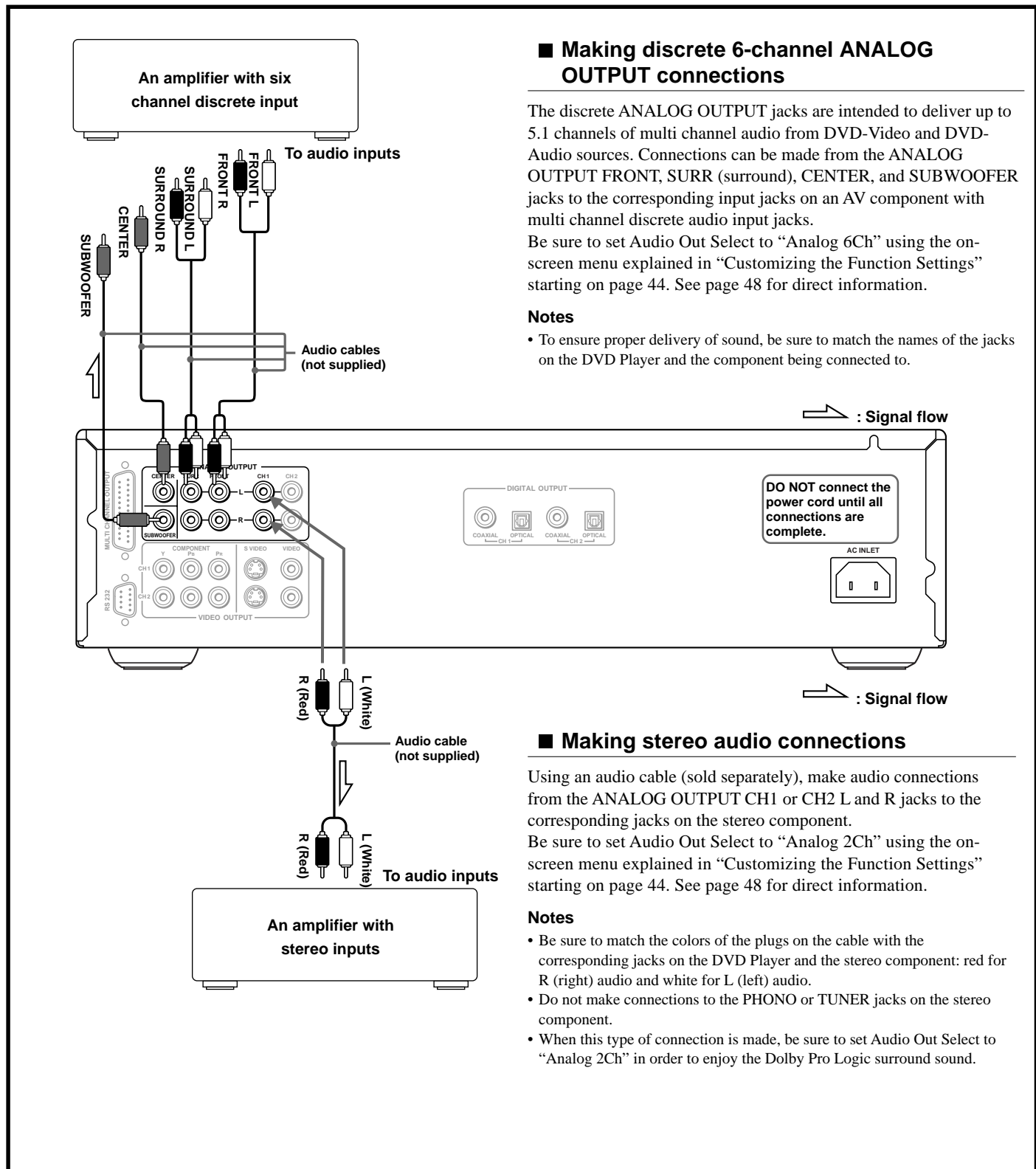

■ Making MULTI CHANNEL OUTPUT connection

The MULTI CHANNEL OUTPUT is a DB-25 port that can output up to 5.1 channels of decoded analog audio from DVD-Video and DVD-Audio sources to a receiver or other AV component that features a similar input port. Ideally you want to connect two identical ports together via a single DB-25 cable. Be sure to set Audio Out Select to "Analog 6Ch" using the on-screen menu explained in "Customizing the Function Settings" starting on page 44. See page 48 for direct information.

Notes

- When connecting the cable, be sure to secure the locking screws on the DB-25 connectors.
- The output from this port is the same as from the 6-channel ANALOG OUTPUT jacks.

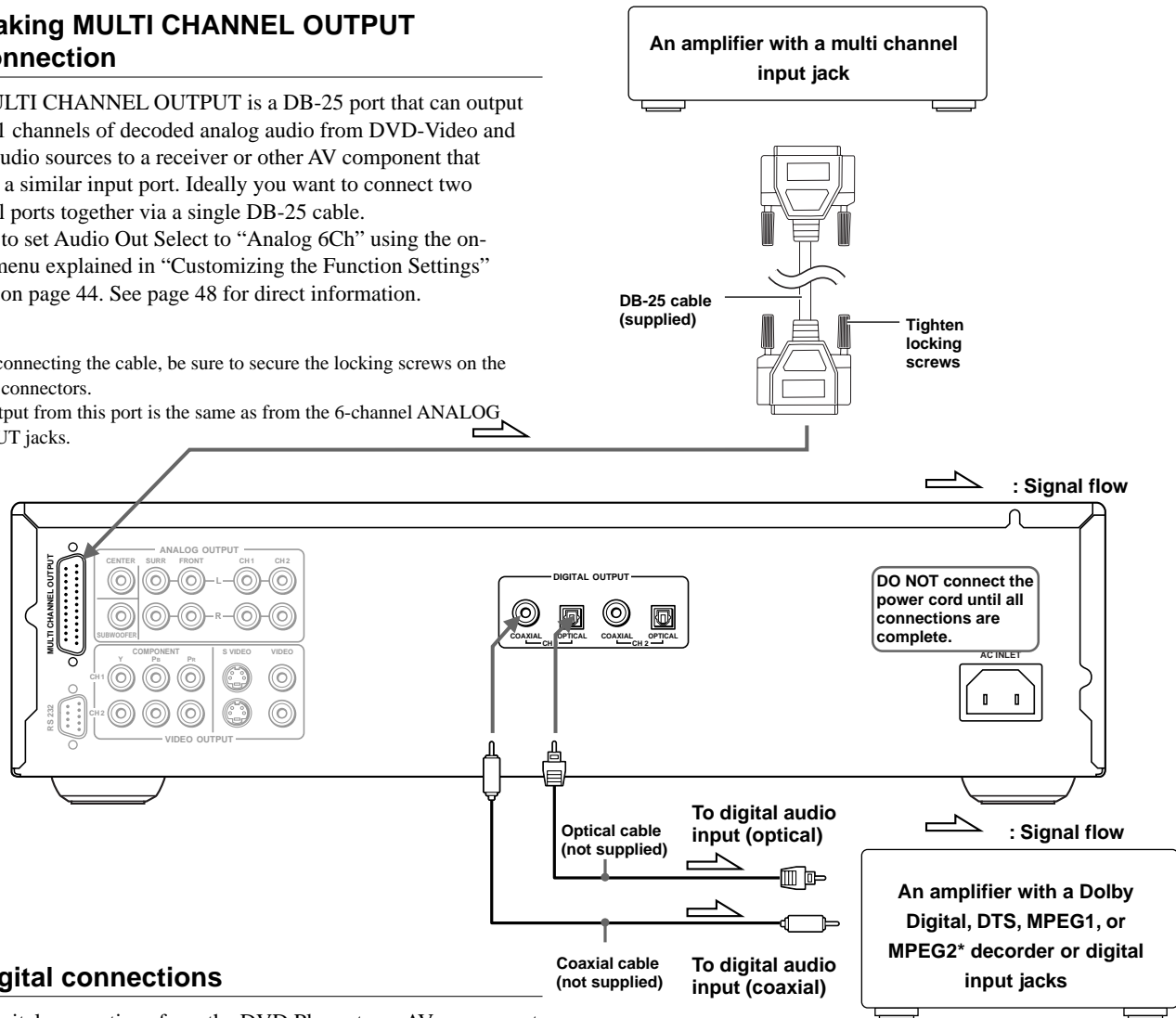

■ Digital connections

Make digital connections from the DVD Player to an AV component that features digital input capability or one or more multi-channel audio decoders to realize the full cinematic experience made possible by the DVD format. This DVD Player features two sets of optical and coaxial digital audio output jacks and can output Dolby Digital, DTS, and MPEG2* bitstreams as well as outputting standard PCM.

Make connections from the DIGITAL OUTPUT OPTICAL CH1 or CH2 jacks to the digital optical input jack on the AV component using an optical fiber cable (sold separately). Make connections from the DIGITAL OUTPUT COAXIAL CH1 or CH2 jacks to the digital coaxial input jack on the AV component using a coaxial cable (sold separately). It is not necessary to make more than one type of digital connection to a single component.

When you are making connections to an amp or receiver that has internal Dolby Digital, DTS, or MPEG decoding capabilities, set Audio Out Select to "Bitstream" using the on-screen menu explained in "Customizing the Function Settings" starting on page 44. See page 48 for direct information.

When you are making connections to an amp or receiver that has digital input capabilities, but no internal decoder, set Audio Out Select to "PCM" using the on-screen menu explained in "Customizing the Function Settings" starting on page 44. See page 48 for direct information. Setting Audio Out Select to any other setting could result in digital noise being output that could cause harm your hearing and may also damage your speakers.

Notes

- Refer to the instructions supplied with the AV component for details on what digital audio formats it is compatible with.
- After making digital audio connections, be sure to set Audio Out Select appropriately for the type of digital signal the connected AV component is compatible with using the on-screen menu explained in "Customizing the Function Settings" starting on page 44. See page 48 for direct information.
- Even if digital audio connections are made, it is also recommended to make analog connections, because some conditions or media may prohibit digital audio output.

* Not applicable for USA and Canadian models

Control Position and Names

Rear panel

For operational instructions, see the page indicated in brackets [].

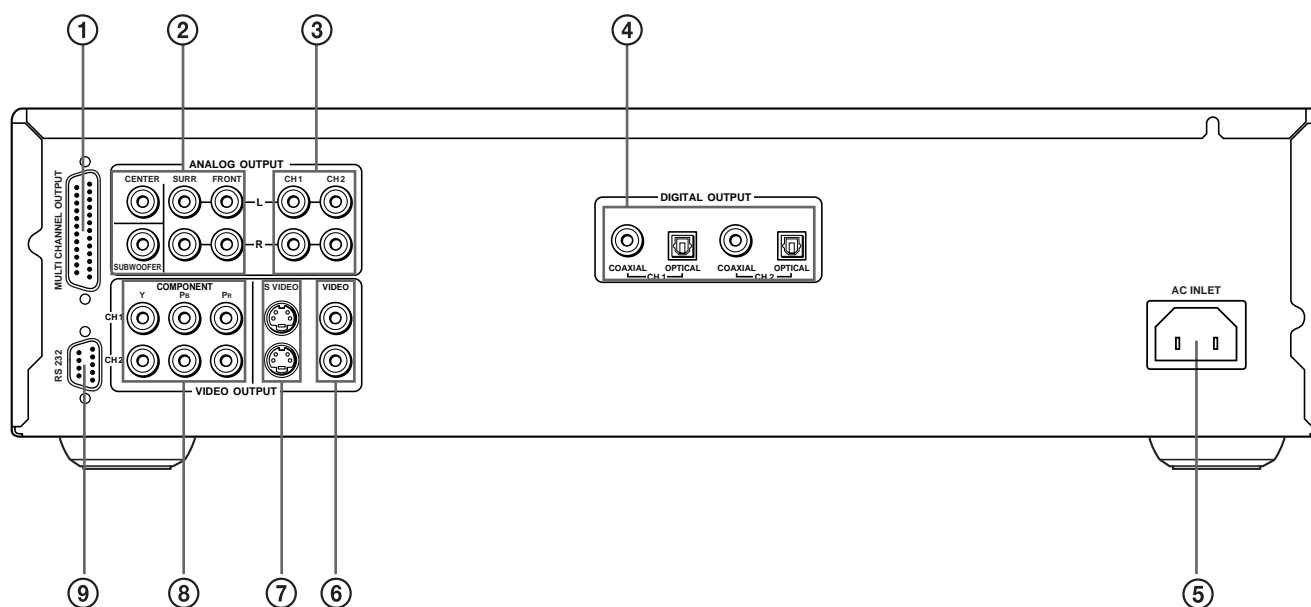

- ① 5.1-Channel SURROUND AUDIO OUT MULTI CHANNEL OUTPUT terminal [13]
- ② 5.1-Channel ANALOG OUTPUT [12]
- ③ 2-Channel ANALOG OUTPUT [10,12]
- ④ DIGITAL OUTPUT COAXIAL, OPTICAL [13]
- ⑤ AC INLET [17]
- ⑥ VIDEO output [10]
- ⑦ S VIDEO output [11]
- ⑧ COMPONENT (PROGRESSIVE) VIDEO output (Y/P_B/P_R) [11]
- ⑨ RS 232 port (This port is to be used in conjunction with an external controller to control the operation of the DPS-9.1 using an external device.)



Front Panel

For operational instructions, see the page indicated in brackets [].

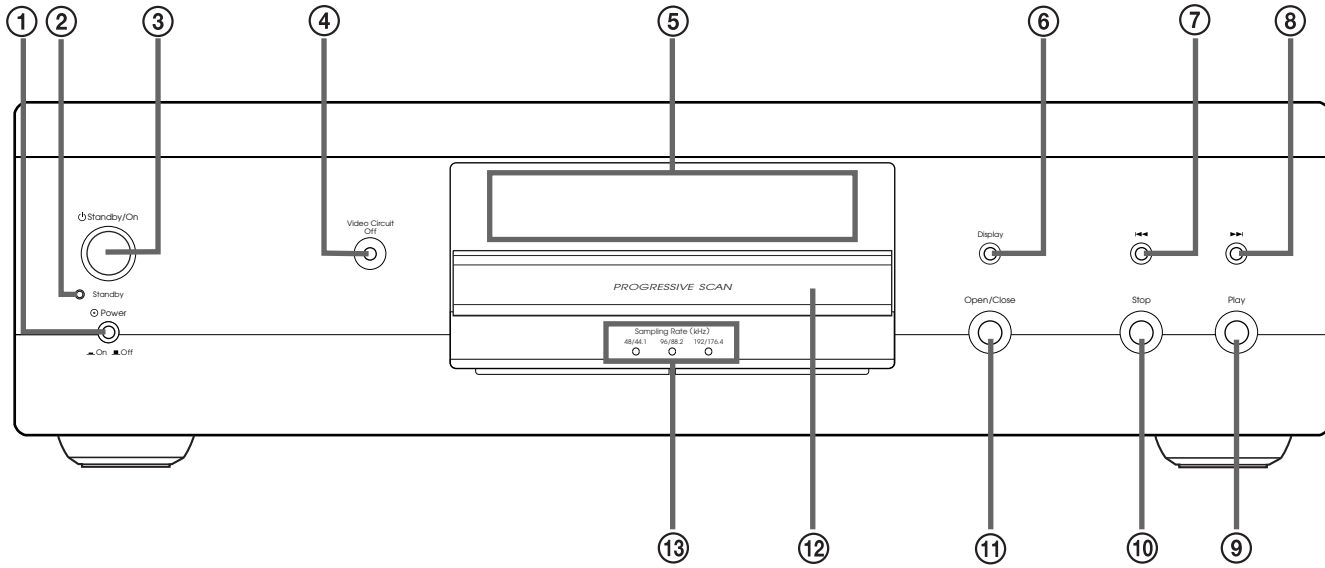

- ① Power button [17]
- ② Standby indicator [17]
- ③ ⏻ Standby/On button [17]
- ④ Video Circuit Off button [43]
- ⑤ Front panel display [16]
- ⑥ Display button [16, 38]
- ⑦ ⏪ button [26]
- ⑧ ⏩ button [26]
- ⑨ Play button [20]
- ⑩ Stop button [21]
- ⑪ Open/Close button [20]
- ⑫ Disc tray [20]
- ⑬ Audio sampling rate indicators [20]

Control Position and Names

Display

For operational instructions, see the page indicated in brackets [].

■ Repeatedly pressing DIMMER on the remote controller changes the brightness of the display

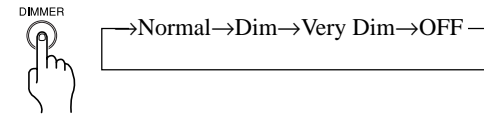
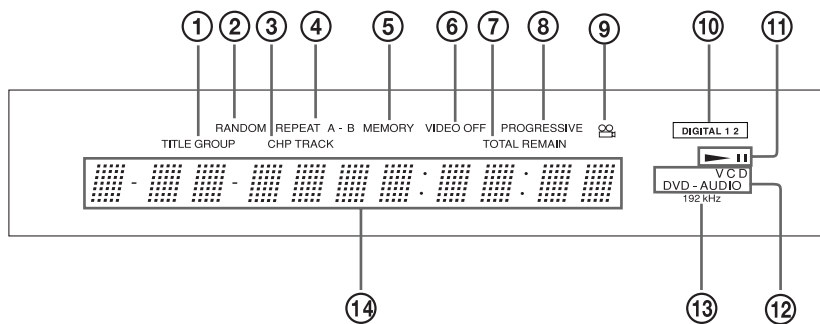

- ① TITLE/GROUP indicator
- ② RANDOM indicator [29]
- ③ CHP (Chapter)/TRACK indicator
- ④ REPEAT indicators [27]
- ⑤ MEMORY indicator [28]
- ⑥ VIDEO OFF indicator [43]
- ⑦ TOTAL playing time/REMAINING time elapsed time indicator
- ⑧ PROGRESSIVE indicator [42]
- ⑨ Angle icon indicator [32]
- ⑩ Play mode indicators
- ⑪ Inserted disc indicator [20]
- ⑫ 192 kHz Processing indicator
- ⑬ Multifunction indicator (Indicates operating status, messages, etc.)

By repeatedly pressing **DISPLAY** on the front panel of the DVD Player, you can switch between the elapsed time and remaining time displays.

■ DVD-Video

During playback:

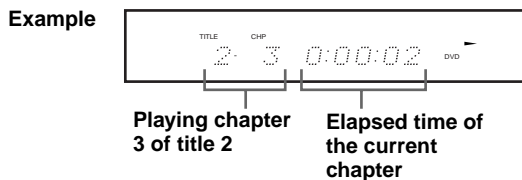

Notes

- Some discs may not display chapter numbers.
- A time indication not accompanied with a chapter number shows elapsed time of a segment within the current time.

■ Video CD

During playback:

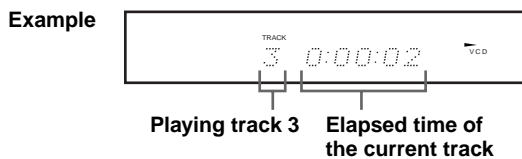

Note

Some discs may not display track numbers or elapsed time.

■ DVD-Audio

During playback:

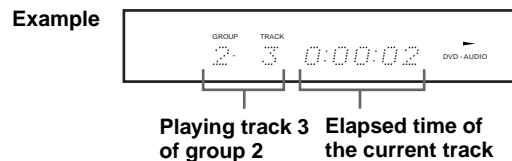

■ CD

During playback:

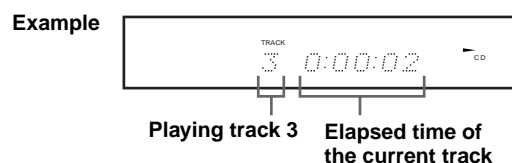

Connecting the Power/ Turning on the DVD Player

Before connecting the POWER

- The DPS-9.1 is shipped with the main power (Power) switch in the on position (■ On). When the power cord is plugged in for the first time, the DPS-9.1 will automatically enter the standby state and the Standby indicator will light (same condition after step 2 below).
- Make sure that all appropriate connections have been completed as described on pages 10 to 13.
- Turning on the DVD Player may cause a momentary power surge, which might interfere with other electrical equipment such as computers. To prevent interference, use a wall outlet on a different circuit.

1 Plug the supplied power cord into the AC INLET and then into the power outlet on the wall.

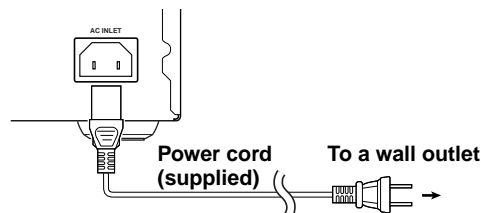

Notes

- Do not use a power cord other than the one supplied with the DPS-9.1. The power cord supplied is designed for use with the DPS-9.1 and should not be used with any other device.
- Never have the power cord disconnected from the DPS-9.1 while the other end is plugged into the wall outlet. Doing so may cause an electric shock. Always connect by plugging into the wall outlet last and disconnect by unplugging from the wall outlet first.

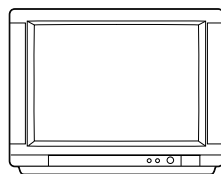

2 Press Power to switch on the main power.

The DVD Player enters standby mode.
The Standby indicator lights up.

Notes

- The buttons on the remote controller do not operate if the Power switch is set to OFF.
- To switch off the main power, press **Power** again.

3 Press Standby/On on the DVD Player or ON on the remote controller.

The DVD Player turns on and the Standby indicator turns off.

The first time you turn on the DVD Player, the Initial Setup screen appears.

Press **ENTER**, then follow the procedure on page 54 to set up your DVD Player for the first time.

Notes

- To put the DVD Player in the standby mode, press  **Standby/On** on the DVD Player, or **STNBY** (or **ON**) on the remote controller. Be sure to set the volume to minimum before putting the DVD Player in the standby mode for the next use to avoid sudden loud sound reproduction.
- While the Standby indicator lights up, the DVD Player can receive signals from the remote controller. However, if you press **Power** on the DVD Player to switch off the main power, the remote controller cannot be used to turn on the DVD Player.
- You can change the First Setup later with "Customizing the Function Settings" starting from page 44.
- Setting the **Standby** button to standby does not shut off the power completely.

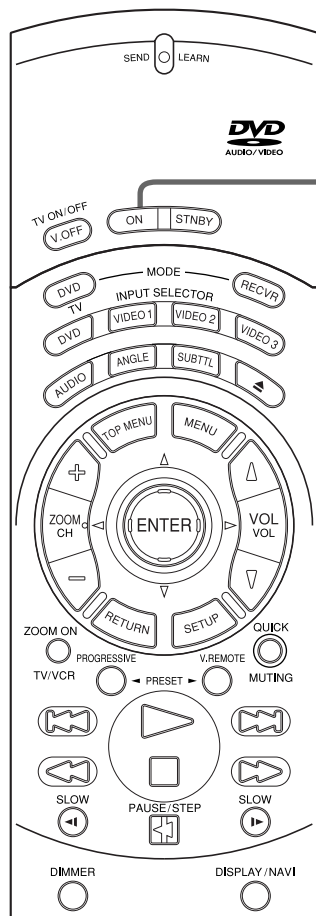

Setting up the DVD Player for Optimal Performance

Using the Remote Control to Navigate On-screen Displays

On-screen navigation is a simple procedure that is done mostly by using ▲/▼/◀/▶ and **ENTER** on the supplied remote controller. To move the highlighted section on the screen (cursor), simply press the edge of the button that corresponds to the direction you wish to move in (▲/▼/◀/▶). Press the center of the button (**ENTER**) to enter settings or selections.

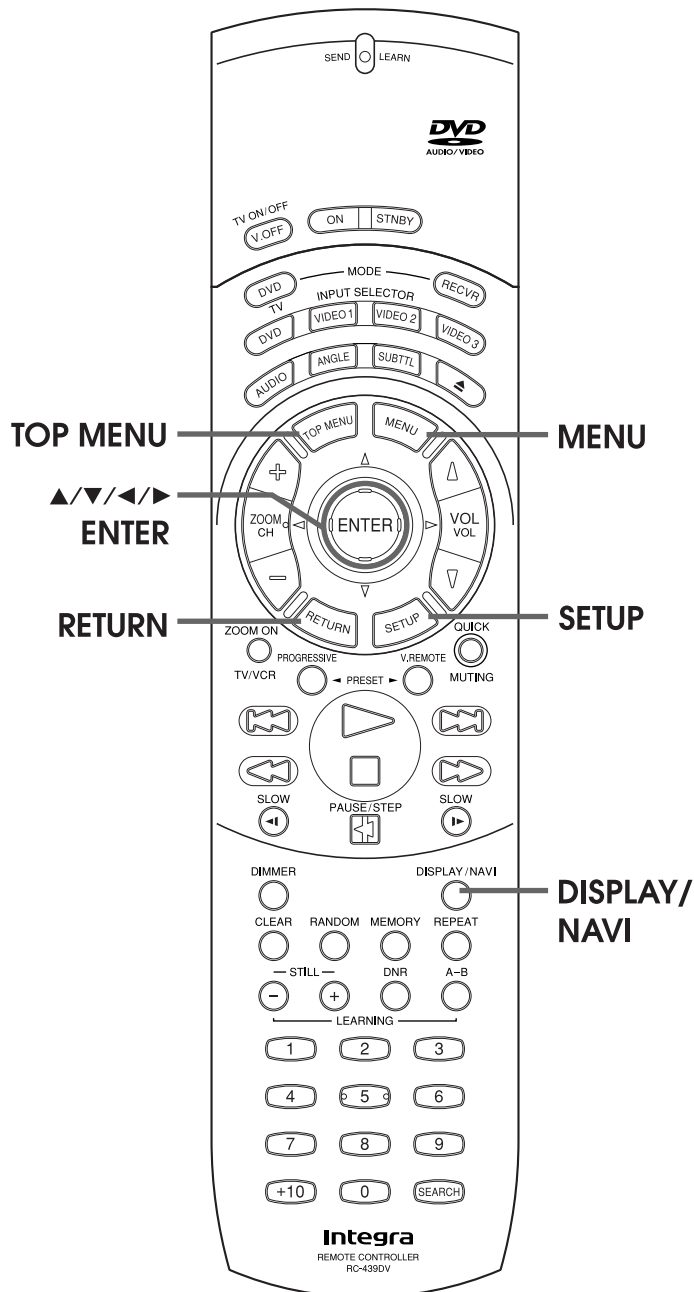

About the disc menu DVD-V DVD-A

A DVD-Video or DVD-Audio may include more than one language and more than one sound system. In many instances, such DVD let you choose the language (e.g. disc menu language/audio language/subtitle language), sound system, and so on using the menu.

Depending on the disc, the name of the disc menu varies and the disc menu may be included in the main menu.

About the title menu DVD-V DVD-A VCD

DVD-Video, DVD-Audio, or Video CD with PBC (Playback Control) function (see "About Video CDs" on page 7) may let you locate a title, chapter, group, or track (see page 7) using the menu.

Depending on the disc, the name of the title menu varies and the title menu may be included in the main menu.

The following buttons are also used in conjunction with on-screen navigation.

- SETUP:** Press to display the Setup screen when you wish to make changes or adjustments in the DVD Player performance settings. For details of the DVD Player settings, refer to "Customizing the Function Settings" starting from page 44.
- MENU and TOP MENU:** These button select the menu screen(s) recorded on DVD media.
- DISPLAY/NAVI:** This button displays information about the current settings of the disc loaded in the player and also offers a variety of playback options (see page 38).
- RETURN:** Press to return to a previous screen or setting. This button is convenient when you do not wish to change a setting or selection.



DVD-V DVD-A

Various sound formats and sound effects

Minimum speaker configuration for DTS/Dolby Digital/MPEG2* surround sounds

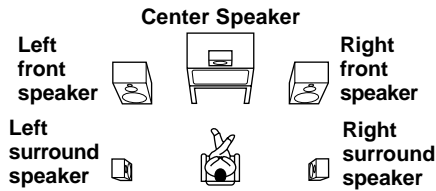

The 5.1-channel digital surround format of DOLBY DIGITAL/DTS/MPEG2* enables you to individually play five full-range (20 Hz-20 kHz) channels (left and right front, center, two surround channels) plus an LFE (Low Frequency Effect) channel for the low-range effect sound. It will create a realistic sound as heard in theaters and concert halls.

DOLBY DIGITAL Surround

DVD Video that have the  mark are recorded using this system.

DTS Surround

DVD Video and CD that have the  mark are recorded using this system.

MPEG2*

DVD Video that have the  Multichannel mark are recorded using this system. MPEG2* may have 8 channels. In this case, left and right center speakers in addition to the above speaker configuration are used.

DOLBY PRO LOGIC Surround

This surround format consists of 4 channels (left and right front, center, and monaural surround channel) and emphasizes the center channel. This format is very effective for panning music, conversation, and three-dimensional sound movement output from three front channels. It also simulates the atmosphere and surround effects of the sound reflected from the side and rear walls of the theater.

DVD Video that have the  mark are recorded using this system.

* Not applicable for USA and Canadian models



Playing DVD-Video/Audio, Video CD, and CD

Before playing

- DVD-Video, DVD-Audio, Video CD, CD, CD-R and CD-RW can be played with the DVD Player (see "Playable Discs" on page 6). Do not play anything else.
- When playing DVD-Video, Video CD, or DVD-Audio with video features, turn on the TV and set the TV to the DVD Player's input.
- If an audio system is connected to the DVD Player, turn on the audio system and set it to the DVD Player's input.

About the DVD-V, DVD-A, VCD and CD marks in the pages related to disc operation

- DVD-A means the function or title is related to DVD-Audio operation.
- DVD-V means the function or title is related to DVD-Video operation.
- VCD means the function or title is related to Video CD operation.
- CD means the function or title is related to audio CD operation.

Warning

If the DVD Player is connected to the TV or amplifier through the analog audio jacks, do not play DTS-encoded discs. Excessive noise may be output from the analog stereo jacks, which may damage the connected equipment.

To reproduce DTS surround sounds, digital connection to an amplifier with a DTS decoder is needed.

DVD-V DVD-A VCD CD

Basic Playback

1 Press Open/Close.

The disc tray opens.

If the DVD Player is in standby mode when the button is pressed
The DVD Player turns on and the disc tray opens. In this case, it takes several seconds until the disc tray opens.

2 Place a disc on the disc tray.

Put the disc in the tray with the label side facing up.
There are two different disc sizes. Place the disc in the correct guide on the disc tray.

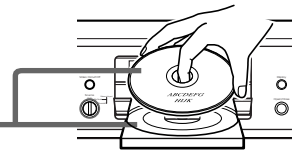

Whenever a disc is loaded in the player, Stop and Play are highlighted.

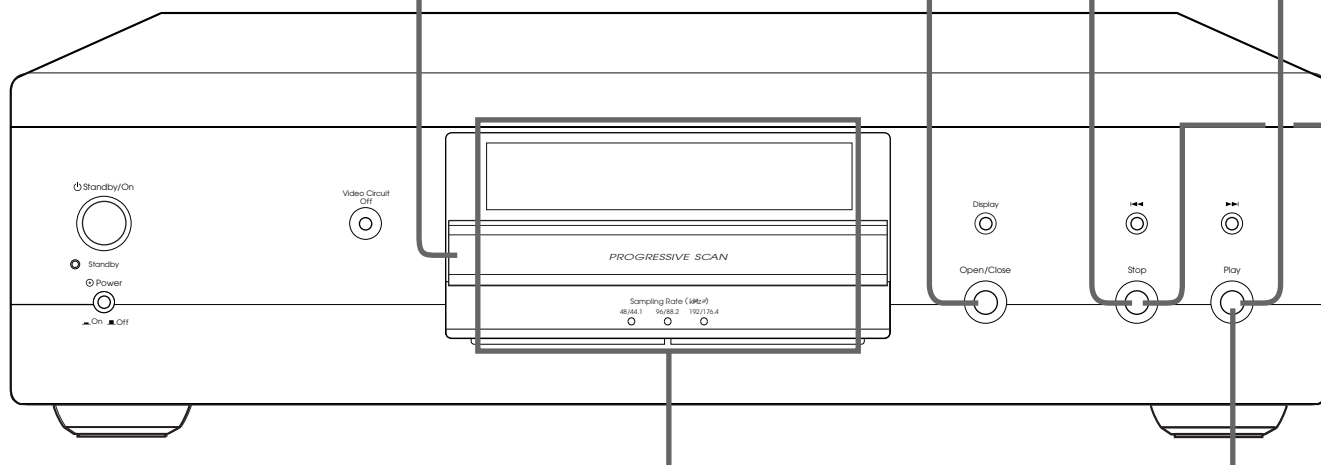

3 Press Play.

The disc tray closes and playback starts.
If you press Open/Close to close the tray after step 2, playback may automatically start depending on the disc.

The appropriate disc indicator lights, and the audio sampling rate indicator also lights. For the other information that appears in the display, see page 35.

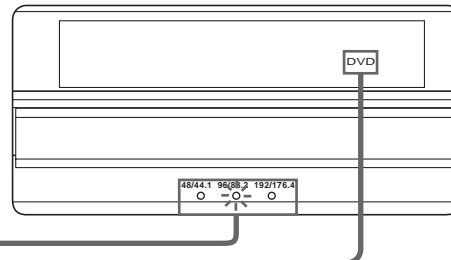

CAUTION

Keep your fingers well clear of the disc tray as it is closing. Neglecting to do so may cause serious personal injury.

If the screen on the right appears - Screen Saver

If you pause for a long time, the screen saver operates.
To resume normal playback, press ►
(You can set this function to Off using the menu explained in "Customizing the Function Settings" starting from page 44. See page 51 for direct information.)



Tip to obtain a higher quality picture

Occasionally, some picture noise not usually visible during a normal broadcast may appear on the TV screen while playing a DVD-Video because the high resolution pictures on these discs include a lot of information. While the amount of noise depends on the TV you use, you should generally adjust the TV to reduce sharpness when viewing DVD-Videos.

■ To remove the disc

Press ▲ to open the disc tray.
Remove the disc after the disc tray opens completely.
After removing the disc, be sure to press the button again to close the tray.

■ To pause playback (still mode)/ Playing frame by frame

Press [] during playback.
To start playback, press ►.

To play frame by frame

Press the button repeatedly during pause. Each time you press the button the picture advances one frame.
To resume normal playback, press ►.

Notes

- The sound is muted during still mode and frame by frame playback.
- When using a DVD-Audio that includes pictures, this operation may be permitted in some picture segments.

■ To stop playback

Press ■.
When you press ► to restart playback, playback starts from the location where you stopped playback because the location index is stored in memory.

Note

The location where playback resumes may vary depending on the disc or the scene where you stopped.

Resuming playback from the beginning

Press ■ again after stopping playback to clear the location index memory, then press ► to start playback.

- Playback starts from the beginning of the current title.
- Playback starts from the beginning of the current group.
- Playback starts from the beginning of the disc.

To start playback from the beginning of the DVD-Video or DVD-Audio, press ▲ to open the disc tray then press ► to close the disc tray and start playback.

Notes

- The location index memory will also be cleared when:
- The power cord is unplugged.
 - The disc tray is opened.
 - The parental lock setting is changed (see page 52) or a disc menu language is selected (see page 50).
 - The location where playback resumes may vary depending on the disc or the scene where you stopped. With DVD-Audio, playback may restart from the beginning of the track.
 - To change the Audio Out Select (see page 48) or the On-Screen Language (see page 50) settings, press ■ after stopping playback to clear the location index. Please note that resumed playback is not possible after this is done.

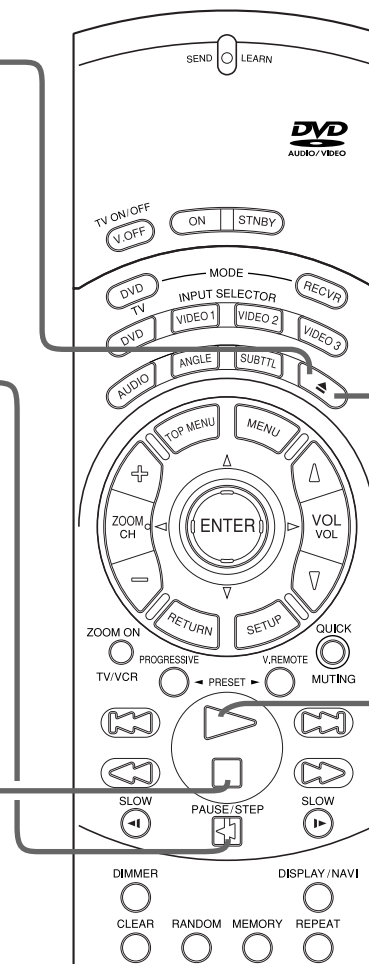

Notes

- Do not move the DVD Player during playback. Doing so may damage the disc.
- Use ▲ on the remote controller or DVD Player to open and close the disc tray. Do not touch the disc tray while it is moving. Doing so may cause the DVD Player to malfunction.
- Do not press down on the disc tray or put any objects other than playable discs on the disc tray. Doing so may cause the DVD Player to malfunction.
- In many instances, a menu screen appears when playback of a movie is complete. Prolonged display of an on-screen menu may damage your television set, permanently etching that image onto its screen. To avoid this, be sure to press ■ once the movie is complete.

Playing DVD-Video/Audio, Video CD, and CD

■ To play in fast reverse or fast forward

DVD-V DVD-A VCD CD

During normal playback, press ◀◀ for fast reverse playback or ▶▶ for fast forward playback.

Each press of the same button changes the playback speed.

The rate and direction of playback is indicated by arrow marks (◀ or ▶) in the corner of the screen.

To resume normal playback.

Press ▶.

Notes

- The DVD Player mutes sounds and omits subtitles during reverse and forward scan of DVD-Video.
- The playback speed may differ depending on the disc.
- Fast reverse and fast forward playback may not be possible with some DVD-Audio.

■ To play in slow-motion

DVD-V VCD

Press SLOW during playback.

▶▶ :Each time you press ▶▶, the slow-motion speed changes.

◀◀ :If you press ◀◀ during playback, you can view the picture in reverse slow motion. (Only when using a DVD-Video.)

Each time you press ◀◀, the slow motion speed changes.

To resume normal playback.

Press ▶.

Notes

- The sound is muted during slow-motion playback.
- The playback speed may differ depending on the disc.
- When using a DVD-Audio that includes pictures, this operation may be permitted in some picture segments.

■ To control still pictures

DVD-A

DVD-Audio may include still pictures, which are classified into two large groups.

Slideshow: Still pictures appear one after another automatically consistent with the disc program.

Browsable pictures: You can display your favorite still picture selected with the buttons on the remote control.

STILL +/-: To select a picture. (The order of pictures vary depending on the disc.)

RETURN: To return to an initial one programmed on the disc.

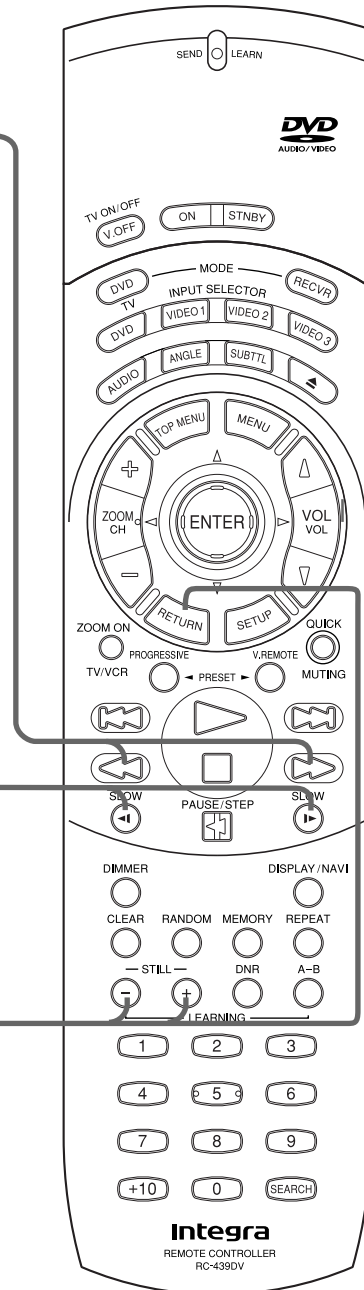



Locating a Specific Title/Group/Chapter/Track/Location

The structure of the disc content

DVD-Video

Normally, the contents of DVD-Video are divided into titles, and the titles are subdivided into chapters.

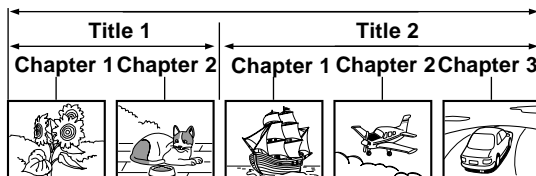

DVD-Audio

The contents of DVD-Audio are divided into groups, and the groups are subdivided into tracks.

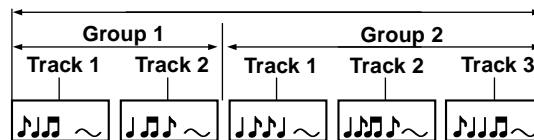

DVD-V

Locating a Title Using the Title Menu

If a DVD-Video contains a title menu, you can locate a specific title using the title menu function.

1



Press TOP MENU. (Depending on the DVD-Video, press MENU.)

The title menu appears on the TV screen.

Example of a title menu.

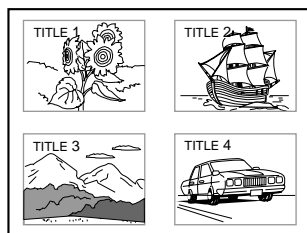

2



Press ▲/▼/◀/▶ to select the title you want.

If the titles in the title menu are assigned a number, you can also directly locate a specific title using the number buttons.

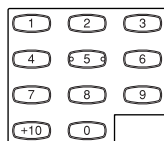

3

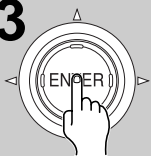

Press ENTER.

The DVD Player starts playback from chapter 1 of the selected title.

Notes

- The instructions above describe basic procedures which may vary depending on the contents of the DVD-Video. If different instructions appear on the TV screen, follow those instructions.
- If you display the title menu during playback and press **TOP MENU** again without selecting any title, the DVD Player usually resumes playback from the point where you first pressed **TOP MENU**. (There may be exceptional cases depending on the disc.)
- This method of locating a title is available only on a disc that contains a top menu.
- The name of the button in the instruction notes of discs varies depending on the disc.



Video CD/CD

Video CD and CD are divided into tracks.

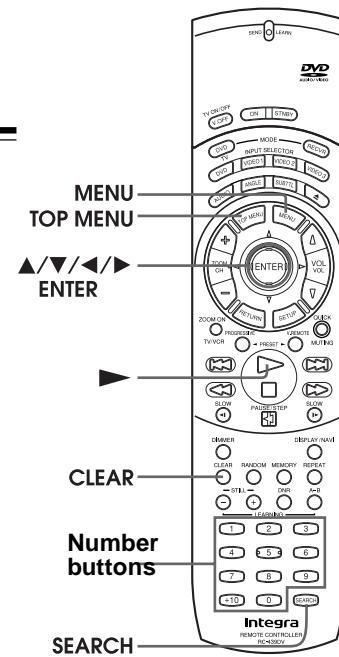

DVD-V DVD-A VCD CD

Locating a specific title and chapter or group and track by entering the numbers

If a DVD-Video or DVD-Audio contains the numbers corresponding to the titles and chapters, or group and tracks you can locate a specific chapter in a specific title directly by entering the numbers.

1



Press SEARCH.

Skip steps 1 and 2 if you are using a Video CD/CD.

The following display appears.

e.g.

DVD-V	DVD-A
Title: 1	Group: 1
Chapter: 1	Track: 1

2

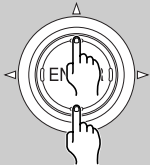

Press ▲/▼ to select a section you want to locate.

e.g. When you want to locate a chapter or track.

e.g.

DVD-V	DVD-A
Title: 1	Group: 1
Chapter: 1	Track: 1

3

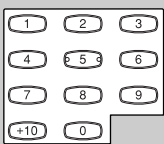

Press the corresponding number buttons for the section you want.

e.g. To select chapter or track 25.

2 → 5 3
or
+10 → +10 → 5 3

4

Repeat steps 2 and 3 if necessary.

5



Press ►.

The DVD Player starts playback from the selected section.

Notes

- Pressing **CLEAR** resets the numbers. To clear the display, press **SEARCH** several times.
- This method of locating a title/group is available only on a disc that contains title/group numbers.

■ Playing bonus groups of DVD-Audio

Some DVD-Audio may include an extra content called "Bonus Group".

If you select it to play, a display appears to enter a key number. Press the number buttons on the remote control to enter the key number.

When the number is entered correctly, playback of the bonus group starts.

To get key numbers, refer to instruction note of discs.

Notes

- A key number may be called in some cases such as when removing the disc. Enter the key number again if necessary.
- When you use a bonus group in a programmed play such as memory playback, enter the key number beforehand.

Locating a Specific Title/ Group/Chapter/Track/Location

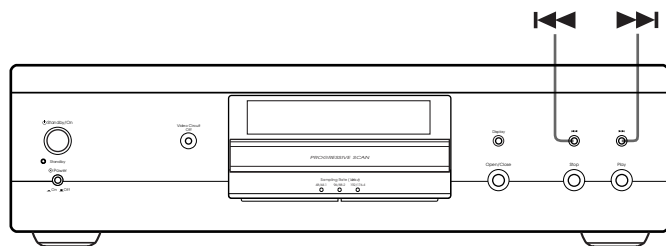

DVD-V DVD-A VCD CD

Locating a Specific Chapter or Track Consecutively

You can locate consecutive chapters or tracks.

Remote controller

DVD Player

Press ◀◀ or ▶▶ (repeatedly) to select the chapter or track you wish to start playing.

Press ◀◀ once to start playback from the beginning of the current chapter or track. Press ◀◀ repeatedly to select the former chapters or tracks in reverse order. Press ▶▶ repeatedly to select the next chapter or track in order.

Notes

- Some titles may not display chapter numbers. Some groups may not display track numbers.
- When you set "Title/Group Stop" to "Off" (see page 53), you can locate consecutive chapters in another title or tracks in another group. If you go back to the preceding title or group by pressing ◀◀, the DVD Player locates the first chapter of the title or the first track of the group. When "Title/Group Stop" is set to "On", you can locate consecutive chapters or tracks only within the current title or group.

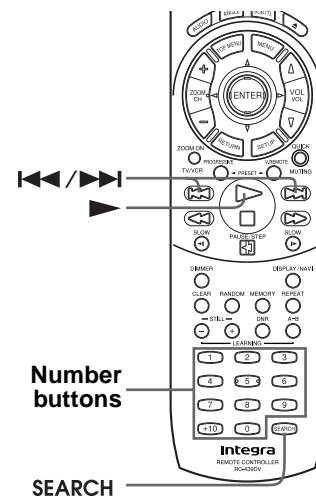

DVD-V VCD CD

Locating a Specific Location by Entering the Time

You can locate a specific location by entering its corresponding time (hours, minutes, and seconds).

- 1 Press SEARCH twice.**

You may need to press the button more than twice (depending on the disc) until the following display appears.

Time ■■■■■■
- 2 Press the number buttons to enter the location's time.**

The entered number appears on the right end of the field, then shifts to the left each time the next number is entered.

e.g. 1 → 2 → 5 3 → 3 → 0

Hours	Minutes	Seconds
Time	1	25:30

Note
If the location time you enter exceeds the total playing time of the disc, the setting will be cancelled.
- 3 Press ▶.**

The DVD Player starts playback from the entered location.

Notes

- Some discs may not respond to this procedure.
- Some scenes may not be located precisely.
- This method for accessing specific locations is available only within the current title of the DVD-Video or within the current track of the Video CD/CD.

Playing Repeatedly

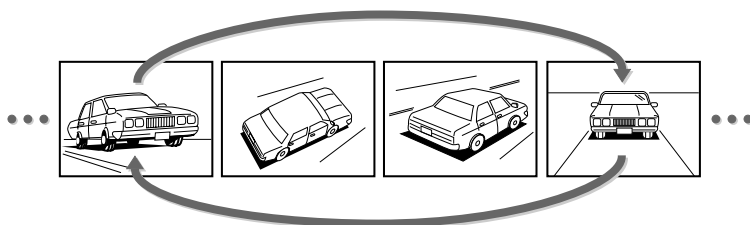

You can play a specific title, group, chapter, track, or segment repeatedly (Title/Group repeat, chapter/track repeat, A-B repeat).

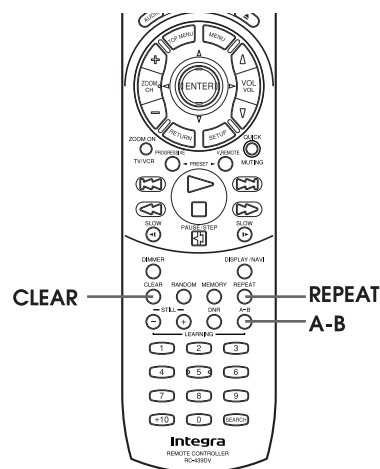

DVD-V DVD-A VCD CD

Repeating a Title, Group, Chapter, or Track

You can play the same title, group, chapter, or track repeatedly (Title/group, chapter/track repeat).

Press REPEAT.
Each time you press **REPEAT**, the repeat mode changes as follows.

	Chapter Repeat	Repeats the current chapter.
DVD-V	Chapter Repeat	Repeats the current chapter.
DVD-A	Track Repeat	Repeats the current track.
DVD-V	Title Repeat	Repeats the current title.
DVD-A	Group Repeat	Repeats the current group.
VCD	Track Repeat	Repeats the current track.
CD	Track Repeat	Repeats the current track.
DVD-V	All Repeat	Repeats the entire disc.
DVD-A	All Repeat	Repeats the entire disc.
VCD	All Repeat	Repeats the entire disc.
CD	All Repeat	Repeats the entire disc.
	Repeat Off	Resumes normal playback.

To resume normal playback

Press CLEAR.

Note

- Some discs may not permit repeat operation.
- When playback is stopped, be sure to press within about 5 seconds after you select the repeat play mode.

DVD-V VCD CD

Repeating a Specific Segment

You can play a specific segment repeatedly (A-B repeat).

- Press A-B at the beginning of the segment (point A) you want to play repeatedly.**

A -
- Press A-B again at the end of the segment (point B).**

A - B

The DVD Player automatically returns to point A and starts repeat playback of the selected segment (A-B).

To resume normal playback

Press CLEAR.

Notes

- Some discs may not permit A-B repeat operation.
- You can play a specific segment only within the current title, chapter, or track.
- You cannot set the A-B repeat function for segments that include multiple camera angles.
- There may be a slight difference between point A and the location where playback actually resumes depending on the disc.

Playing in a Favorite Order



You can combine your favorite titles, groups, chapters, or tracks and play them in any order. You can program up to 30 selections into the memory (Memory playback).

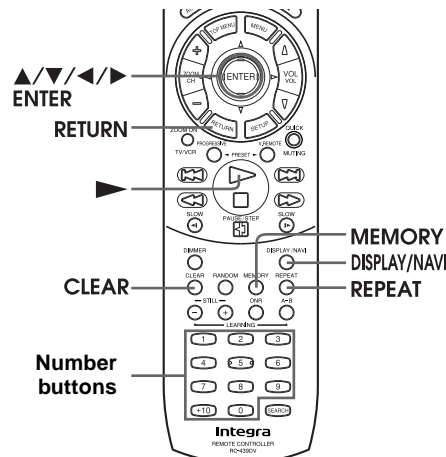

DVD-V DVD-A VCD CD

Setting Titles, Groups, Chapters, or Tracks in a Favorite Order

The DVD Player automatically plays titles, groups, chapters, or tracks in the order you program.

1 **MEMORY**

Insert a disc and press MEMORY while the disc is stopped.

The following display appears.

TG: Title number or group number
CT: Chapter number or track number

VCD CD

Press the number button(s) to select the track number, then press ENTER to confirm.

Repeat this step to select the next track. The space of "TG" may be showing a number. Neglect this number when using a Video-CD/CD.

2

1 Press the number button(s) to enter the title or group number.
2 Press ► to highlight "--" below CT.
3 Press the number button(s) to enter the chapter or track number.
4 Press ENTER to confirm.

To select another chapter/track in the same title/group
Press the number button(s) for another chapter/track.

e.g. To play chapter 25 in title 2, chapter 12 in title 2, all the chapters in title 1, and chapter 2 in title 4.

	Title number	Chapter number
Step 1	2	25
Step 2		12
Step 3	1	
Step 4	4	2

3 **While the Memory List is displayed, press ►.**

The DVD Player starts memory playback.

■ To change the entered step

While the Memory List is displayed, press ▲/▼ to highlight the item. To select another title/chapter, group/track, or track, follow step 2.

■ To cancel the entered step

While the Memory List is displayed, press ▲/▼ to highlight the item. To cancel, press CLEAR.

■ To resume normal playback

Press CLEAR.
The memory playback indicator disappears.

■ To program during playback

If you press MEMORY during playback, the display to accept your programming appears. To display the Memory List, press QUICK, press ▲/▼ to select Memory List, then follow steps 2 and 3.

Notes

- You can also use +10 (plus ten button) to add ten to the number.
- Some discs may not permit memory playback operation.
- If you press REPEAT during memory playback, the DVD Player repeats the current memory playback.
- If you press MEMORY or RETURN while the "Memory List" display appears on the TV screen, the "Memory List" display disappears.
- The programmed selections will be cleared when you turn off the DVD Player.

Playing in Random Order

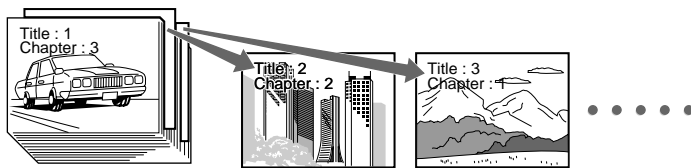

You can play titles, chapters within a title, or tracks in random order (Random playback).

DVD-V VCD CD

Playing Titles, Chapters or Tracks in Random Order

The DVD Player automatically selects the titles in DVD-Video, or tracks in Video-CD, CD, and plays them randomly.

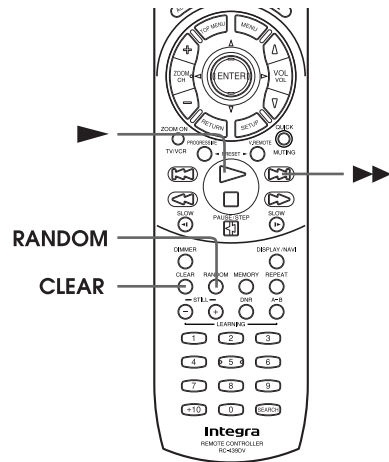

Press RANDOM repeatedly to change the random play mode as follows.

	Chapter Random	Plays the chapters within the current title in random order.
↓	Title Random	Plays the titles in random order.
↓	Track Random	Plays the tracks in random order.
↓	Track Random	Plays the tracks in random order.
↓	Random Off	Resume normal playback.

If you press **RANDOM** during playback, the DVD Player automatically starts random playback after finishing the current title, chapter or track.

■ To resume normal playback



Press CLEAR.

Notes

- Some discs may not permit random playback operation.
- You cannot use the random playback function together with the memory playback function.
- If you press **▶▶▶** during random playback, the DVD Player goes to another title or track and continues random playback.

Note

When playback is stopped, be sure to press **▶** within about 5 seconds after you select the random play mode.

Zooming a Picture

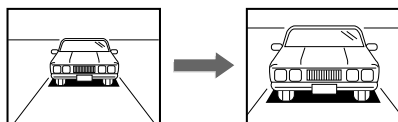

You can magnify areas within a picture.

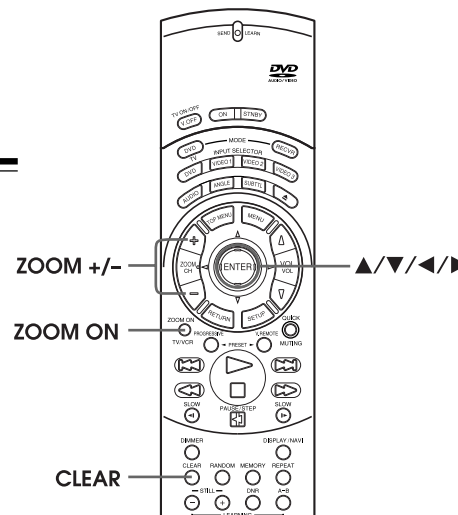

DVD-V

Zooming a Picture and Shifting the Zoom Point

You can zoom in on a picture. You can also shift the zoom point.

ZOOM ON



ZOOM



ZOOM +/-



CLEAR



Press ZOOM ON during normal, slow, or still playback.
Adjust the magnification of the screen using ZOOM + (to enlarge) and ZOOM - (to reduce).

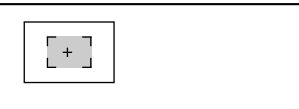

To shift the zoom point
Press ▲/▼/◀/▶.

To restore the original zoom point (center of the picture)
Press CLEAR.

■ To resume normal playback



Press ZOOM ON repeatedly so that "Zoom Off" appears.

Notes

- Some discs may not permit zoom operation.
- During some scenes, the buttons may not work as described above.
- Zooming does not work on subtitles or menu screens included on DVD-Video.
- While a zoom operation is being performed, it is not possible to select the DVD menu. To select the DVD menu, cancel the zoom operation to resume normal playback, and then select the DVD menu.
- The magnification level varies depending on the picture size you select (see pages 44 and 46).
- When using a DVD-Audio disc that includes pictures, this operation may be permitted in some picture segments.

Improving Picture Quality

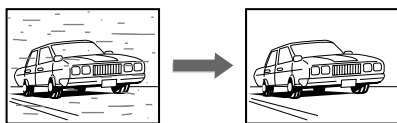

You can view a picture with less video noise.

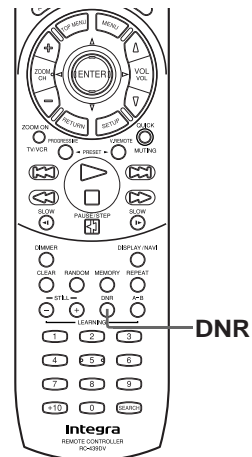

DVD-V VCD

Selecting DNR Picture Enhancement



Press DNR on the remote controller during playback.

The current setting is displayed. Each time you press **DNR**, the setting changes as follows.

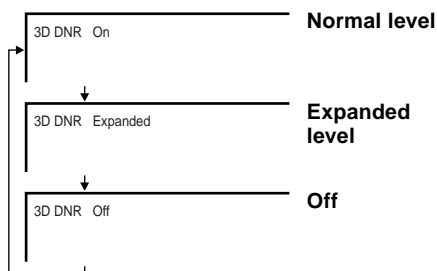

3D DNR: Three Dimension Digital Noise Reduction

Notes

- Actual picture enhancement may vary depending on the quality of the disc.
- Depending on the DNR setting selected, there may be no improvement in the picture quality. When this is the case, set DNR to "Off".
- Depending on the DNR setting, some kinds of picture details may be lost by the picture enhancement.
- Depending on the disc, some kinds of picture details may be lost by the picture enhancement.
- When using a DVD audio disc that includes pictures, this operation may be permitted in some picture segments.



Selecting the Camera Angle

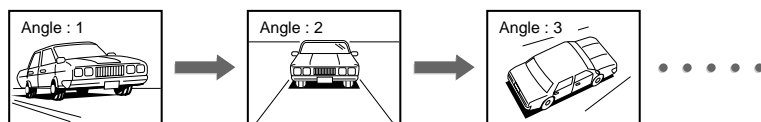

You can select a preferred camera angle to watch a scene.

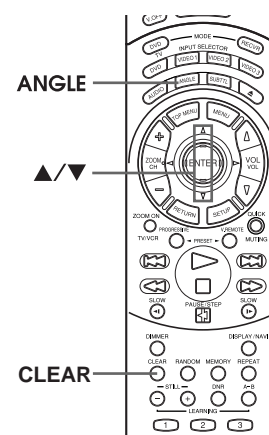

DVD-V

Changing the Camera Angle

If the scene was recorded from multiple angles, you can easily change the camera angle of the scene you are watching.

1



Press ANGLE while playing a scene recorded with multiple angles.

While playing a scene recorded with multiple angles, the angle icon (📷) appears in the DVD display and on the TV screen. Press **ANGLE** while the angle icon is displayed.

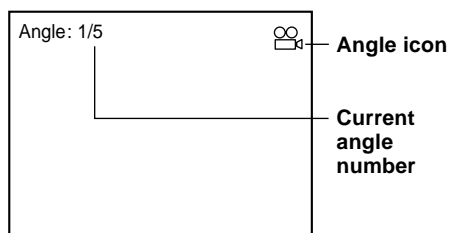

To disable the angle icon display on the TV

Set "On-Screen Displays" to "Off" using the setting menu (see pages 44 and 51).

Monitor the DVD display when you want to change the camera angle.

Notes

- You can change the camera angle during still playback. The camera angle changes to the new setting when you resume normal playback.
- If you pause a picture immediately after changing the camera angle, the resumed playback picture may not use the new camera angle.
- When using a DVD-Audio that includes pictures, if there are sections during which multiple angles are recorded, it may be possible to change the camera angle.

2



Press ANGLE or ▲ while the angle number is displayed on the TV screen.

Each time you press **ANGLE** or **▲**, the camera angle changes.

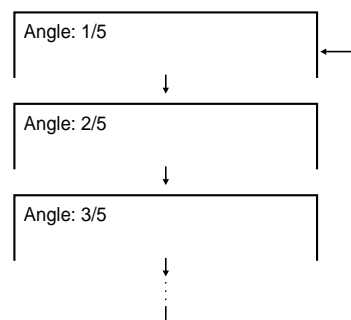
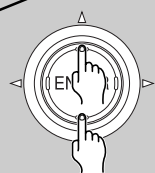

▼ : Cycles backwards

You can also change the camera angle directly by pressing the number buttons corresponding to the angle number.

To turn off the angle number display

Press **CLEAR**.

Selecting the Subtitle Language/ Turning On/Off Subtitles

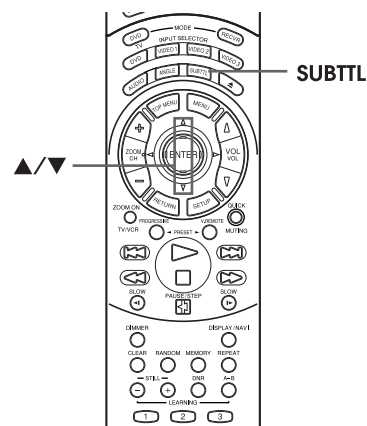

You can display subtitles on the TV screen and select a subtitle language from those included on the DVD-Video.

DVD-V

Selecting a Subtitle Language

You can select a subtitle language from those included on the DVD-Video.

1



Press SUBTTL during playback.

The current subtitle setting is displayed for about 3 seconds.

Subtitle: 1 ENG On
Language

The abbreviation of the language appears instead of the language name. See the list of languages and their abbreviations on page 55.

2



Press SUBTTL or ▲ while the subtitle setting is displayed on the TV screen.

Each time you press **SUBTTL** or **▲**, the subtitle languages included on the DVD-Video disc change.

e.g.

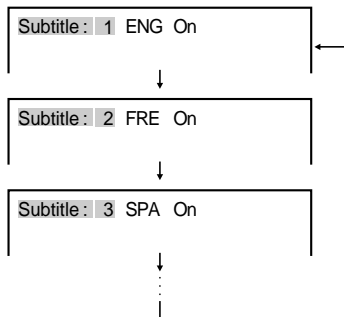

▼ : Cycles backwards

To turn off the subtitle setting display Press **CLEAR**.

DVD-V

Turning Subtitles On/Off

1



Press SUBTTL during playback.

The current subtitle setting is displayed for about 3 seconds.

2

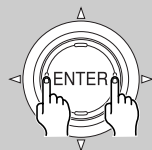

Press ◀▶ while the subtitle setting is displayed on the TV screen, to select "On" or "Off".

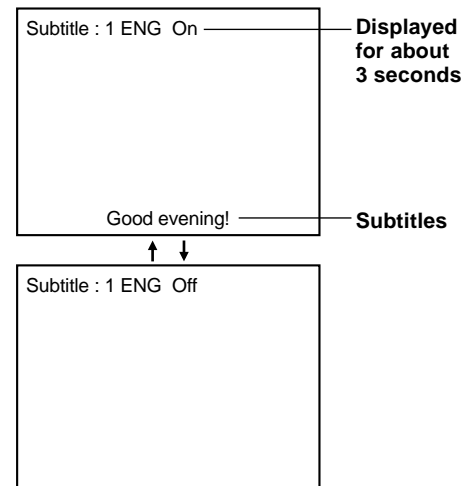

Notes

- Some DVD-Video are set to display subtitles automatically, and you cannot turn them off even if you set the subtitle function to off.
- During some scenes, the subtitles may not appear immediately after you select "On".
- Some DVD-Video will allow you to make subtitle selections and turn subtitles on or off only by using the disc menu.
- When using a DVD-Audio that includes pictures, if subtitle information has been recorded on the disc, it may be possible to select a subtitle language.

Notes

- When you turn on the DVD Player or replace a disc, the DVD Player returns to the automatic setting in the setting menu (see pages 44 and 50).
- When you select a subtitle language which is not included on the disc, the DVD Player plays the prior language programmed on the disc.
- During some scenes, the subtitles may not appear immediately after you change the subtitle language by pressing ▲/▼.

Selecting the Audio Language

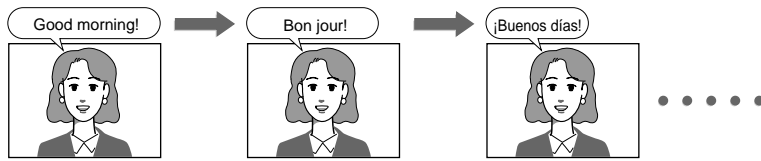

You can select a preferred audio language and sound system.

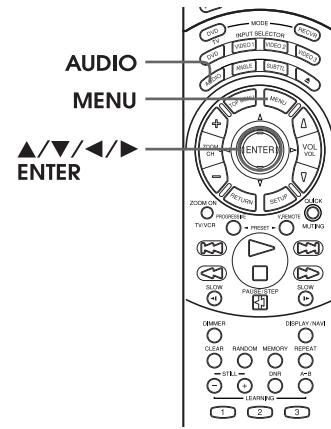

DVD-V DVD-A

Selecting a Playback Audio Setting

You can select the preferred audio language and sound system as a set from those included on the disc. This function lets you temporarily change the audio language which you selected as the automatic setting in the setting menu (see pages 44 and 50), and choose the sound system if the disc is recorded in more than one sound format.

Notes

- Depending on the disc, it may be necessary to select the audio sound track using the DVD menu. When this is the case, press **MENU** to open the DVD menu and select the appropriate sound track as indicated on the DVD menu screen.
- When the DVD Player is turned on or when the disc is changed, the audio settings are restored to the presets. In some cases, a language recorded on the disc may be given priority and selected automatically when the disc is loaded regardless of the setting.
- Depending on the DVD-Audio, the sampling frequency and bitrate may be displayed.
- When using a DVD-Audio, changing the audio sound track may cause playback to start again from the beginning of the current track.

1 Press **AUDIO** during playback.

e.g. DVD-V

Audio language
Sound system
Audio channel

Audio: 1 ENG PCM 2CH
Audio OUT Select : Bitstream

Audio Out Select (see page 48)

The abbreviation of the language appears. Refer to the list of languages on page 55.

2 Press **AUDIO** or **▲** while the audio setting is displayed on the TV screen.

Each time you press **AUDIO** or **▲**, the language and audio recording system set changes.

e.g. DVD-V

Audio: 1 ENG □□ 5.1CH
↓
Audio: 2 ENG PCM 2CH
↓
Audio: 3 FRE □□ 5.1CH
↓

▼ : Cycles backwards

To turn off the audio setting display
Press **CLEAR**.

Notes

- Dolby Digital 5.1 Channel sound may be displayed as "□□D 6CH".
- You can change the "Audio Out Select" setting temporarily by pressing **◀▶**.
- When using a DVD-Audio, it may not be possible to change the "Audio Out Select" setting.
- Before changing the setting, read through the explanation on "Audio Out Select" on page 48 and carefully select the setting.

VCD

Selecting Sound Channels on Video CD

A Video CD may have left and right sound channels which contain sounds or languages on each channel. You can switch these two channels to hear a preferred sound or language.

During playback, press **AUDIO** (repeatedly) to select the sound channel.

L.R

Both the left and right channels are heard.

L

The left channel is heard.

R

The right channel is heard.

Output Sound Conversion Table

Audio Output from the DIGITAL OUTPUT and ANALOG OUTPUT Jacks Corresponding to Disc Formats and the DVD Player Settings

Disc	Sound System	Audio Out Select setting and the output jacks								
		Bitstream		Analog 6Ch		Analog 2Ch		PCM		
		DIGITAL OUTPUT	ANALOG OUTPUT	DIGITAL OUTPUT	ANALOG OUTPUT	DIGITAL OUTPUT	ANALOG OUTPUT	DIGITAL OUTPUT	ANALOG OUTPUT	
DVD Video	DOLBY DIGITAL	Bitstream	48 kHz/20 bit	—	48 kHz/20 bit	Bitstream	48 kHz/20 bit	48 kHz/16 bit	48 kHz/20 bit	
	Linear PCM	48 kHz/16 bit	48 kHz/16 bit	48 kHz/16 bit	48 kHz/16 bit	48 kHz/16 bit	48 kHz/16 bit	48 kHz/16 bit	48 kHz/16 bit	48 kHz/20 bit
		48 kHz/20 bit	48 kHz/16 bit	48 kHz/20 bit	48 kHz/16 bit	48 kHz/20 bit	48 kHz/16 bit	48 kHz/20 bit	48 kHz/16 bit	48 kHz/20 bit
		48 kHz/24 bit	48 kHz/16 bit	48 kHz/24 bit	48 kHz/16 bit	48 kHz/20 bit	48 kHz/16 bit	48 kHz/24 bit	48 kHz/16 bit	48 kHz/24 bit
		96 kHz/16 bit	48 kHz/16 bit	48 kHz/16 bit	48 kHz/16 bit	48 kHz/16 bit	—	96 kHz/16 bit	48 kHz/16 bit	48 kHz/16 bit
		96 kHz/20 bit	48 kHz/16 bit	48 kHz/20 bit	48 kHz/16 bit	48 kHz/20 bit	—	96 kHz/20 bit	48 kHz/16 bit	48 kHz/20 bit
	96 kHz/24 bit	48 kHz/16 bit	48 kHz/24 bit	48 kHz/16 bit	48 kHz/20 bit	—	96 kHz/24 bit	48 kHz/16 bit	48 kHz/24 bit	
DTS	Bitstream	—	Bitstream	—	Bitstream	—	—	—		
MPEG2 ^{*1}	Bitstream	48 kHz/16 bit	—	48 kHz/16 bit	Bitstream	48 kHz/16 bit	48 kHz/16 bit	48 kHz/16 bit		
Video CD	MPEG1	44.1 kHz/16 bit	44.1 kHz/16 bit	—	44.1 kHz/16 bit	44.1 kHz/16 bit	44.1 kHz/16 bit	44.1 kHz/16 bit	44.1 kHz/16 bit	
CD	Linear PCM 44.1 kHz/16 bit	44.1 kHz/16 bit	44.1 kHz/16 bit	44.1 kHz/16 bit	44.1 kHz/16 bit	44.1 kHz/16 bit	44.1 kHz/16 bit	44.1 kHz/16 bit	44.1 kHz/16 bit	
	DTS	Bitstream	(Noise is output)	Bitstream	(Noise is output)	Bitstream	(Noise is output)	Bitstream	(Noise is output)	
DVD Audio	Linear PCM or packed PCM	44.1 kHz/16 bit	44.1 kHz/16 bit	44.1 kHz/16 bit	—	44.1 kHz/16 bit	44.1 kHz/16 bit	44.1 kHz/16 bit	44.1 kHz/16 bit	
		48 kHz/16 bit	48 kHz/16 bit	48 kHz/16 bit	—	48 kHz/16 bit	48 kHz/16 bit	48 kHz/16 bit	48 kHz/16 bit	
		44.1 kHz/20 bit	44.1 kHz/16 bit	44.1 kHz/20 bit	—	44.1 kHz/20 bit	44.1 kHz/16 bit	44.1 kHz/20 bit	44.1 kHz/16 bit	
		48 kHz/20 bit	48 kHz/16 bit	48 kHz/20 bit	—	48 kHz/20 bit	48 kHz/16 bit	48 kHz/20 bit	48 kHz/16 bit	
		44.1 kHz/24 bit	44.1 kHz/16 bit	44.1 kHz/24 bit	—	44.1 kHz/24 bit	44.1 kHz/16 bit	44.1 kHz/24 bit	44.1 kHz/16 bit	
		48 kHz/24 bit	48 kHz/16 bit	48 kHz/24 bit	—	48 kHz/24 bit	48 kHz/16 bit	48 kHz/24 bit	48 kHz/16 bit	
		88.2 kHz/16 bit	44.1 kHz/16 bit	44.1 kHz/16 bit	—	88.2 kHz/16 bit	—	88.2 kHz/16 bit	44.1 kHz/16 bit	
		96 kHz/16 bit	48 kHz/16 bit	48 kHz/16 bit	—	96 kHz/16 bit	—	96 kHz/16 bit	48 kHz/16 bit	
		88.2 kHz/20 bit	44.1 kHz/16 bit	44.1 kHz/20 bit	—	88.2 kHz/20 bit	—	88.2 kHz/20 bit	44.1 kHz/16 bit	
		96 kHz/20 bit	48 kHz/16 bit	48 kHz/20 bit	—	96 kHz/20 bit	—	96 kHz/20 bit	48 kHz/16 bit	
		88.2 kHz/24 bit	44.1 kHz/16 bit	44.1 kHz/24 bit	—	88.2 kHz/24 bit	—	88.2 kHz/24 bit	44.1 kHz/16 bit	
		96 kHz/24 bit	48 kHz/16 bit	48 kHz/24 bit	—	96 kHz/24 bit	—	96 kHz/24 bit	48 kHz/16 bit	
		*2 176.4 kHz/16 bit	—	176.4 kHz/16 bit	—	176.4 kHz/16 bit	—	176.4 kHz/16 bit	—	
		*2 192 kHz/16 bit	—	192 kHz/16 bit	—	192 kHz/16 bit	—	192 kHz/16 bit	—	
		*2 176.4 kHz/20 bit	—	176.4 kHz/20 bit	—	176.4 kHz/20 bit	—	176.4 kHz/20 bit	—	
*2 192 kHz/20 bit	—	192 kHz/20 bit	—	192 kHz/20 bit	—	192 kHz/20 bit	—			
*2 176.4 kHz/24 bit	—	176.4 kHz/24 bit	—	176.4 kHz/24 bit	—	176.4 kHz/24 bit	—			
*2 192 kHz/24 bit	—	192 kHz/24 bit	—	192 kHz/24 bit	—	192 kHz/24 bit	—			

*1 Not applicable for USA and Canadian models

*2 2Ch Audio Output

—: No signal

Notes

- When using only two speakers for playback and play a multi channel disc that prohibits stereo downmixing, the sound from the right and left speakers will be the right and left channels of the multi channel sound track as recorded on the disc. With these types of discs, it is often possible that a 2-channel stereo sound track may also be recorded. Change the sound track to hear the audio correctly. (For details, refer to the documentation supplied with the disc.)
- During playback of discs recorded with sampling rates higher than 48 kHz (for example 96 kHz), the 48/44.1 sampling rate indicator lights when Audio Out Select is set to either Bitstream or PCM.
- When Audio Out Select is set to Analog 6Ch, two channel audio sources are output with DOLBY PRO LOGIC surround processing (except for DVD-Audio).

Using the Graphic Remote Control - V.REMOTE

Pressing one button can display a graphics based on-screen remote control that allows you to control playback as if you were doing it from the actual remote control.

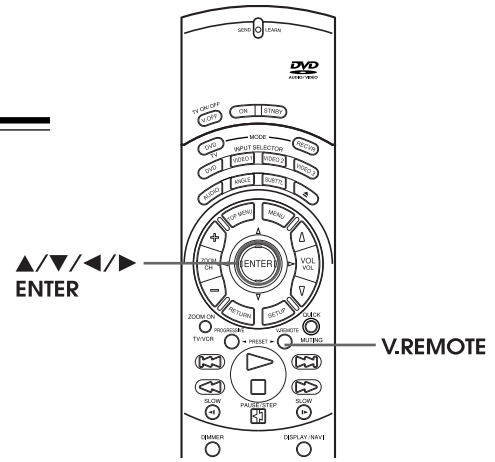

DVD-V VCD CD

Using the Graphic Remote Control

1



During playback, press V.REMOTE.
The graphic remote controller (Virtual Remote) appears on the screen.

e.g. DVD-V

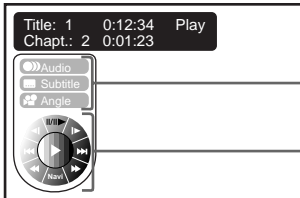

Switch the audio sound track and video selection.

Change the speed and direction of playback.

To turn off the Virtual Remote



Press V.REMOTE.

Note
Some discs may not permit this operation.

2

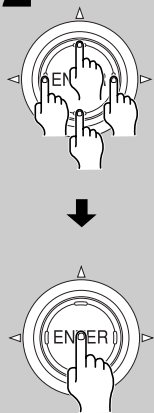

Press ▲/▼/◀/▶ to select a desired item, and press ENTER.

- ⏸/⏪: Pause [21]/Frame by frame [21]
- ▶: Normal playback [20]
- ⏩: Slow [22]
- ⏭: Forward skip [26]
- ⏮: Fast forward [22]
- ⏪: Reverse slow [22]
- ⏮: Reverse skip [26]
- ⏮: Fast reverse [22]
- Navi:** Accesses the Navi menu (DVD-Video only) [38]
- Audio:** Move the cursor control (▲/▼) to select a desired audio language, and press **ENTER**.
For details, see page 34.
Selecting the output sound format is not possible here.
- Subtitle:** Move the cursor control (▲/▼) to select a desired subtitle language, and press **ENTER**.
For details, see page 33.
- Angle:** Move the cursor control (▲/▼) to select a desired camera angle, and press **ENTER**.
For details, see page 32.

Selecting the Playback Function - QUICK

Pressing one button can display a list of playback functions which are relevant to your current playback mode. You can check and modify them from the list.

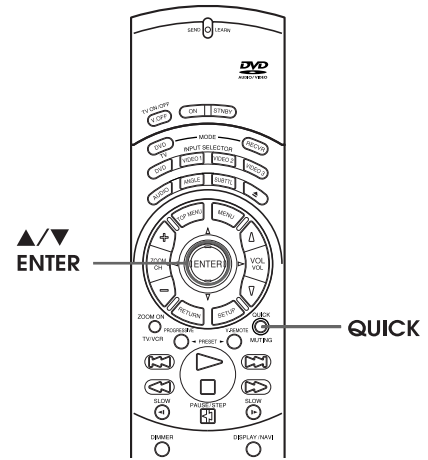

DVD-V DVD-A VCD CD

Selecting the Playback Function

- 1** **QUICK**



During playback, press QUICK.
The following on-screen display appears.
(The actual display will vary depending on the playback status.)

e.g. DVD-V

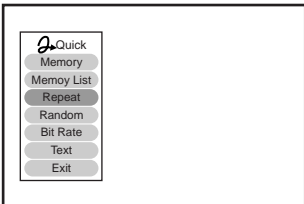

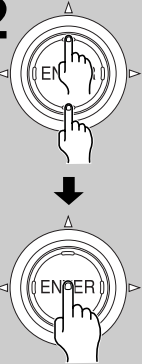
- 2**

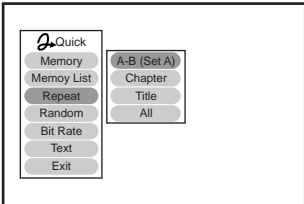

Press ▲/▼ to select a desired item, and press ENTER.

e.g. To change the repeat mode:

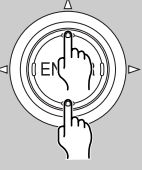

- 3**

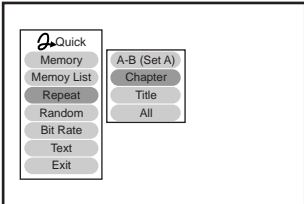

Press ▲/▼ to change the setting.

e.g. To select the chapter repeat mode:

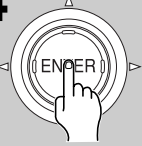
- 4**



Press ENTER.
The on-screen display disappears and playback will resume according to your selection.

Quick menu

For details, see the respective pages.

- Memory:** To program memory playback (see page 28).
- Memory List:** To list memory settings (see page 28).
- Repeat:** To select the repeat playback mode (see page 27).
- Random:** To select the random playback mode (see page 29).
- Bit Rate:** To activate/disable the bitrate display (see page 38).
- Text:** To activate/disable the Text display.
Text display:
Displays DVD-Text data or CD-Text data if included on the disc.
With DVD-Audio, Album text data is displayed if it is recorded on the disc. Track information is not displayed.
(Some text content recorded on the disc may not be displayed properly depending on the disc.)
- Exit:** To quit the on-screen display.

Note

Pressing **QUICK** again also exits the on-screen display.

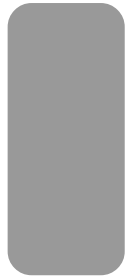

Accessing Playback Features - NAVI

The NAVI menu provides an icon based display from which you can easily access key playback function.

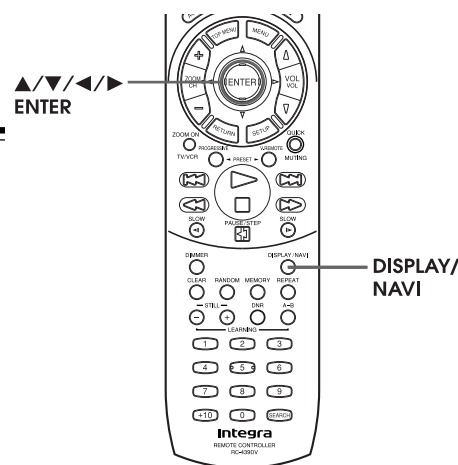

DVD-V DVD-A VCD CD

NAVI menu items

1

DISPLAY/NAVI



Press DISPLAY/NAVI.

The NAVI menu appears.

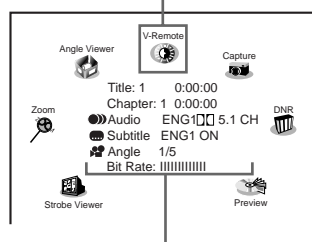

Each time you press DISPLAY/NAVI, the display changes.

Title/Chapter: Elapsed time and remaining time of the current title/chapter.

Audio: Current audio setting.

Subtitle: Current subtitle setting.

Angle: Current angle setting.

Bit Rate: Data transfer rate (Mbit/s)
Amount of picture, sound and subtitle data in the DVD-Video disc transferred per second.
The larger the value, the more data processed, but this does not necessarily insure better picture quality.

Status display (playback mode, current DNR setting, current zoom status, etc.)

When a DVD-Audio is loaded in the player, depending on the audio format (sampling frequency/bitrate) the corresponding indicators are displayed as follows.

C (mono)

The audio is monaural.

L, R (L: Left channel, R: Right channel)

The audio is in stereo.

Lf, Rf, C, LFE, S, Ls, Rs

(Lf: Left front, R: Right front, C: Center,

LFE: subwoofer, S: Surround, Ls: Left surround,

Rs: Right surround)

The audio is multi channel.

2



Press ▲/▼/◀/▶ to select a desired feature icon.

For details on each feature, refer to the list on this page.

3

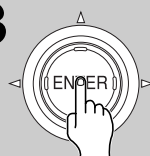

Press ENTER.

Selection details appears.

4

Refer to the list on the next page and follow the instructions detailed on subsequent pages.

Notes

- The NAVI menu will disappear by pressing DISPLAY/NAVI several times.
- The number of feature icons on the display will vary depending on the disc.
- Feature icons are displayed only when you play a DVD-Video.

■ Navi menu selections

V-Remote



You can control key playback functions using the graphic based on-screen control (see page 36).

Angle Viewer



You can display all camera angles simultaneously and select your preferred one from them (see page 39).

Zoom



You can magnify areas within a picture (see page 30).



Strobe Viewer

You can divide a desired scene into stop action frames for careful analysis (see page 39).

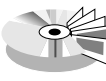

Preview

You can display thumbnail views of the first scenes of titles or chapters and select a preferred one (see page 40).

DNR



You can view a picture with less video noise (see page 40).

Capture



You can sample a scene from a playback picture and transform it into a background picture (see page 41).



Angle Viewer You can display all camera angles simultaneously and select your preferred one from them.



After selecting this icon and pressing **ENTER**, the following on-screen display appears:

e.g.

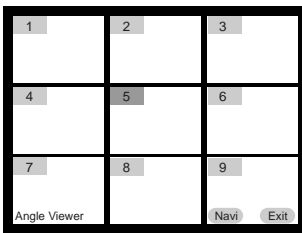

When the scene contains 9 camera angles:

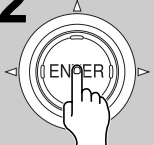
1		<p>Press ▲/▼/◀▶ to select.</p> <p>1-9: To select the camera angle. Navi: To return to the NAVI menu. Exit: To quit the on-screen display.</p>
2		<p>Press ENTER.</p>

Note
Some discs or scenes may not permit this operation.

Strobe Viewer You can divide a desired scene into stop action frames for careful analysis.



Strobe Viewer

After selecting this icon and pressing **ENTER**, the following on-screen display appears:

e.g.

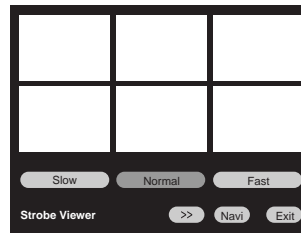

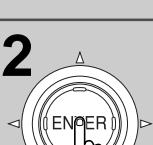
1		<p>Press ▲/▼/◀▶ to select.</p> <p>Slow: Still pictures at shorter intervals. Normal: Still pictures at normal intervals. Fast: Still pictures at longer intervals. >>: To view the next series of 6 pictures. Navi: To return to the NAVI menu. Exit: To quit the on-screen display.</p>
2		<p>Press ENTER.</p>

Note
Some discs or scenes may not permit this operation.

Accessing Playback Features - NAVI

NAVI menu items



You can display thumbnail views of the first scenes of titles or chapters and select a preferred one.

After selecting this icon and pressing **ENTER**, the following on-screen display appears:

e.g.

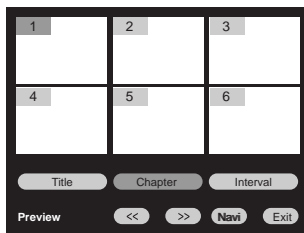

You can view a picture with less video noise.

After selecting this icon and pressing **ENTER**, the following on-screen display appears.

e.g.

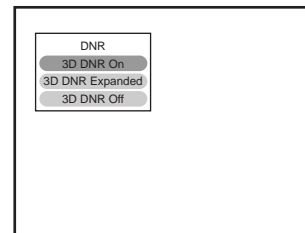

1	<p>Press ▲/▼/◀▶ to select.</p> <p>1 - 6: To locate the scene. Title: To display the first scene of titles (1 to 6). Chapter: To display the first scenes of chapters (1 to 6). Interval: To display scenes at intervals of about 10 minutes apart. <<: To go to the previous page. >>: To go to the next page. Navi: To return to the NAVI menu. Exit: To quit the on-screen display.</p>
2	<p>Press ENTER.</p>

1	<p>Press ▲/▼ to select.</p> <p>3D DNR On: Normal level. 3D DNR Expanded: Expanded level. 3D DNR Off: Off.</p>
2	<p>Press ENTER.</p>

Note

For details and notes on the DNR picture enhancement, see page 31.

Notes

- Some discs or scenes may not permit this operation.
- Some items may not be selected depending on the disc or scene.
- Some of the first scenes may not be picked up depending on the disc.



Capture



You can sample a scene from a playback picture and transform it into a background picture.

After selecting this icon and pressing **ENTER**, the following on-screen display appears.

e.g.

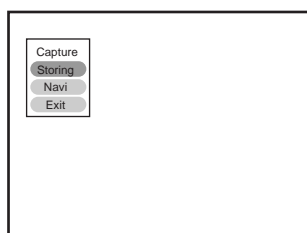

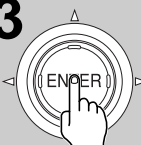
1	Pause playback at a scene you want to capture.
2 	Press ▲/▼ to select. Storing: To sample and store the current picture in the player memory. Navi: To return to the NAVI menu. Exit: To quit the on-screen display.
3 	Press ENTER. The stored picture will be displayed as a background picture when the player is in the stop mode. It is necessary to confirm this process via the setup menu (see page 51).

Notes

- You can store only one picture. Storing a new picture will erase the old one.
- No operations are permitted during the process of the sampling and storage of background picture.



Selecting Progressive Video Output

The DVD Player is capable of outputting progressive scan video. As its name suggests, progressive scan delivers the video image sequentially across the horizontal lines of the TV or monitor rather than the alternating odd and even delivery of an interlace scan. The result is a picture quality that best reflects the quality digital video recorded on the DVD.



DVD-V

Selecting progressive scan

PROGRESSIVE



Press PROGRESSIVE on the remote controller.

The PROGRESSIVE indicator lights in the front panel.

To turn off the progressive scan, press the button again until the PROGRESSIVE indicator disappears.

Notes

- In order for this function to be effective, it is necessary to have made component video connections to a TV or monitor that is compatible with progressive scan.
- This function only works when the color system recorded on the disc is NTSC.

Turning Off the Video Signal Output

The DVD-Player can be set playing audio exclusively. In this case, you can obtain sound of better quality, as the DVD Player does not process video signals. (All the video output jacks send no video signals.)

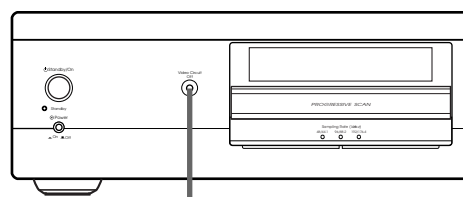

VIDEO CIRCUIT OFF

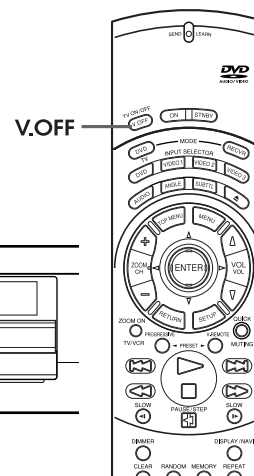

DVD-V DVD-A VCD CD

Switching the video signal off

DVD Player

VIDEO CIRCUIT OFF



Remote controller



Press VIDEO CIRCUIT OFF on the DVD Player or V.OFF on the remote controller repeatedly.

The VIDEO OFF indicator appears on the display. To turn on the video circuitry, press the button again.

Notes

- Some discs cannot be played without some on-screen menu interaction. If this is the case, be sure to perform the on-screen procedures as indicated before turning off the video signal processing circuitry.
- The VIDEO CIRCUIT OFF setting is canceled whenever the DVD Player is turned off.

Customizing the Function Settings

When you insert a DVD-Video, DVD-Audio, Video CD, or CD, the various functions of the DVD Player will be set (reset) according to the setting menu. You can customize this setting menu according to your preferences.

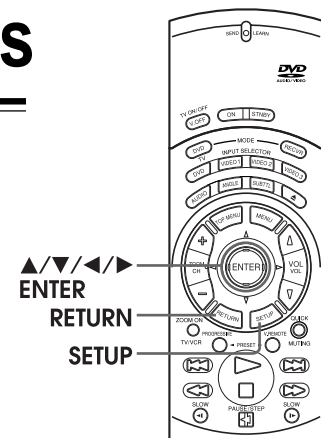

DVD-V DVD-A VCD CD

Making Adjustments to Setting

1 Press **SETUP**.
The following setting menu appears.

Category symbols

Picture	
TV Shape	4:3 LB
Blacker than Black	Off
Setting : Interlaced	1
Setting : Progressive	1
Progressive 4:3 Output Full	
Progressive Conversion Auto	

2 Press **◀▶** to select a category symbol for the setting you want to change.

- Picture performance settings
- Output sound settings
- Language settings
- Display settings
- Operational setting
- Initial settings

3 Press **▲/▼** to select the item you want to change, then press **ENTER**.
e.g. When you select "PICTURE" as the category in step 2, then select "TV Shape" as the item in this step.

Picture	
TV Shape	4:3 LB
Blacker than Black	Off
Setting : Interlaced	1
Setting : Progressive	1
Progressive 4:3 Output Full	
Progressive Conversion Auto	

4:3 LetterBox
4:3 Normal
16:9 Widescreen

4 Press **▲/▼** to change the setting, then press **ENTER**.
e.g. When you change the "TV Shape" setting to "16:9 Widescreen".

Picture	
TV Shape	4:3 LB
Blacker than Black	Off
Setting : Interlaced	1
Setting : Progressive	1
Progressive 4:3 Output Full	
Progressive Conversion Auto	

4:3 LetterBox
4:3 Normal
16:9 Widescreen

5 Further steps may be needed depending on the item or setting. Follow the steps described in the explanation of each item starting from page 46.

6

- To change the setting of other items in the same category, repeat steps 3 to 4.
- To change the setting of an item in a different category, repeat steps 2 to 4.

7 To close the setting menu, press **SETUP**.





















































■ To return to the previously displayed menu

Press **RETURN**.

Notes

- The on-screen display disappears when you press **SETUP**.
- **SETUP** can function even during normal playback, however some operations may be inaccessible, and a message will appear. In this case, try again after playback is stopped.

Reference Table of the Setting Menu

Menu item	Related to*	Details	Page
 TV Shape		To select a picture size according to the aspect ratio of your TV.	46
Blacker than Black	 	To make an adjustment of the black level on your TV using a commercially available test disc that contains adjustment signals.	46
Setting: Interlaced	 	To adjust the picture quality.	46
Setting: Progressive	 	To adjust the picture quality. (Only when connected to a PROGRESSIVE TV.)	47
Progressive 4:3 Output	 	To select the video output of pictures recorded in 4:3 format. (Only when connected to a PROGRESSIVE TV.)	47
Progressive Conversion		To select the system of output signal. (Only when connected to a PROGRESSIVE TV.)	47
 Audio Out Select	   	To select an output sound format corresponding to your system connection.	48
Dynamic Range Control		To turn on or off a function that makes faint sounds easier to hear even if you lower the volume during late hours playback.	49
Karaoke Vocal		To turn on or off the vocal output during DVD KARAOKE disc playback.	49
 On-Screen Language	   	To select a preferred language for on-screen displays.	50
Disc Menu Language		To select a preferred language for disc menus.	50
Audio Language		To select a preferred language for the sound.	50
Subtitle Language		To select a preferred language for subtitles.	51
 On-Screen Displays	   	To turn on or de-activate the operation status display on the TV screen.	51
Background	   	To select the background color or background picture.	51
Screen Saver		To turn the screen saver on or off.	51
 Pause/Still		To select the resolution of still pictures.	52
Parental Lock		To turn the parental lock function on or off.	52
Remote Confirmation	   	To turn on or off the confirmation beeper announcing when each remote command received.	53
Title/Group Stop	 	To turn on or off a feature that automatically stops playback after a title/group has been viewed.	53
PBC		To use the menu screen when playing a PBC-controllable Video CD.	53
Priority Contents	 	To select the playback priority between DVD-Video and DVD-Audio format signals.	53
 On-screen Language TV Shape Audio Out Select	   	To install the initial system setting.	54

* When using a DVD-Audio disc that includes pictures, some setting marked  may be effective.

Customizing the Function Setting

Explanation of Each Item in the Picture Category

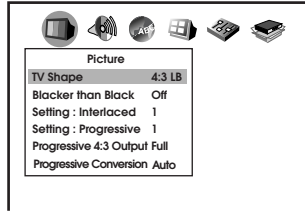

TV Shape



4:3 Letterbox:

Select when a 4:3 TV is connected. Displays theatrical images with masking bars above and below the picture.

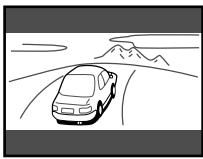

4:3 Normal:

Select when a 4:3 TV is connected. Displays pictures cropped to fill your TV screen. Either or both sides of the picture are cut off.



16:9 Widescreen: Select when a 16:9 wide TV is connected.

Notes

- The displayable picture size is preset on each DVD-Video. Therefore, the playback picture of some DVD-Video may not conform to the picture size you select.
- When you play a DVD-Video recorded in the 4:3 picture size only, the playback picture always appears in the 4:3 picture size regardless of the TV shape setting.
- If you select "16:9 Widescreen" and you own a 4:3 TV set, the DVD playback picture will be horizontally distorted during playback. Images will appear to be horizontally compressed. Make sure the TV Shape conforms to the actual TV in use.

Blacker than Black



Off: For normal use.

On: Select when you adjust the black level of your TV using a commercially available test disc that contains adjustment signals.

Note

With certain discs, the played picture may be disturbed if this item is set to On. In this case, set this item to Off.

Setting: Interlaced



You can fine adjust picture quality and store up to 3 custom picture settings in the memory of the DVD Player.

To select a preset memory setting:

- Press ▲/▼ to select a memory number (1 to 3), and press **ENTER**.

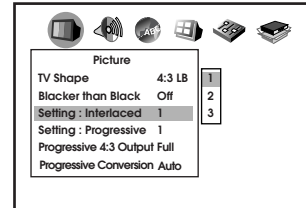

- Press ▲/▼ to select the element, and press **ENTER**.

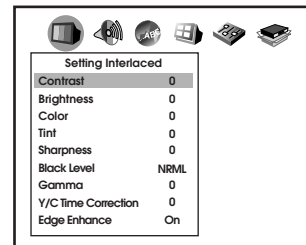

- Press ◀▶ to adjust the value, and press **ENTER**.

(-7) Lower	Contrast	Higher (+7)
(-7) Darker	Brightness	Brighter (+7)
(-7) Duller	Color	Brighter (+7)
(-7) Redder	Tint	Greener (+7)
(-7) Softer	Sharpness	Sharper (+7)
Normal	Black Level	Enhanced
(-)	Gamma*1	(+)
(-3)	Y/C Time Correction*2	(+3)
On	Edge Enhance*3	Off

*1: Adjust when playback pictures are too dark or too whitish.

*2: Adjust horizontal color deviations. Pictures may shift horizontally during the adjustment.

*3: Sharpens the edges of images.

Notes

- These adjustments are not available when connecting to a PROGRESSIVE TV.
- The Tint adjustment is not available when connecting to a TV via the component video jacks (Y, Pb, Pr).



Setting: Progressive



You can fine adjust picture quality and store up to 3 picture setting in the memory of the DVD Player. (Only when connected to a PROGRESSIVE TV.)

To select a preset memory setting:

- 1 Press ▲/▼ to select a memory number (1 to 3), and press the **ENTER** button.

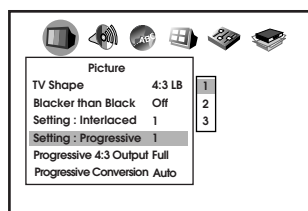

- 2 Press ▲/▼ to select the element, and press the **ENTER** button.

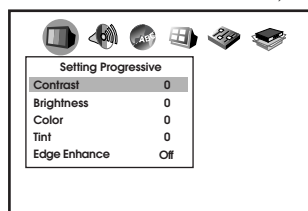

- 3 Press ◀▶ to adjust the value, and press the **ENTER** button.

(-7) Lower Contrast Higher (+7)
(0) Darker Brightness Brighter (+14)
(-7) Duller Color Brighter (+7)
(-7) Redder Tint Greener (+7)

Edge Enhance

To enhance picture edges.

(Off < On < Expanded1 < Expanded2)

Progressive Conversion



There are two types of source content in pictures recorded in DVD-Video: film content (pictures recorded from films at 24 frames per second) and video content (video signals recorded at 30 frames per second). Make this selection according to the type of content being viewed.

- Auto:** Displays this operation normally.
The DVD Player automatically detects source content, film or video, of playback source, and converts it in the progressive output format in an appropriate method.
- Video:** The DVD Player filters video signal, and converts it in the progressive output format appropriately.
Suitable for playback of video content pictures.
- Film:** The DVD Player converts film content pictures in the progressive output format appropriated. Suitable for playback of film content pictures. The progressive output feature will be most effective under this selection.

Note
Depending on the disc, pictures may be cut off or doubled. In this case, select "Video".

Progressive 4:3 Output



Select the video output of pictures recorded in 4:3 format. (Only when connected to a PROGRESSIVE TV.)

- 4:3:** Displays images in 4:3 aspect ratio with masking bars to the left and right of the picture.
- Full:** Displays pictures expanded horizontally to fill the 16:9 screen.



Customizing the Function Settings

Explanation of Each Item in the Audio Category

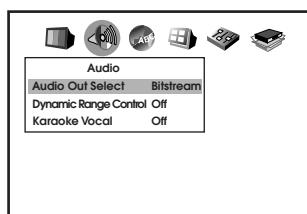

Audio Out Select



Select the output sound format corresponding to your system connection.

For details of sound recording systems, see “Output Sound Conversion Table” on page 35.

- Bitstream:** Select when you connected to an amplifier equipped with a Dolby Digital, DTS, MPEG1 or MPEG2* decoder (see page 13).
The DVD Player outputs digital audio information in the bitstream format when you play a DVD-Video recorded in the Dolby Digital, DTS, MPEG1 or MPEG2* recording system.
- Analog 6Ch:** Select when connected to an AV amplifier equipped with 5.1ch audio inputs.
This DVD Player is equipped with a Dolby Digital and MPEG decoder. The next screen will detail the appropriate settings.
- Analog 2Ch:** Select when connected to a TV, or Dolby Pro Logic or stereo system via the analog audio jacks (see page 12).
- PCM:** Select when connected to a 2 channel digital stereo amplifier (see page 13).
The DVD Player outputs sounds in the PCM 2ch format when you play a DVD-Video disc recorded on the Dolby Digital, MPEG1 or MPEG2* recording system.

* Not applicable for USA and Canadian models

When you select “Analog 6Ch”:

Make the following setting for the built-in 5.1ch surround decoder.

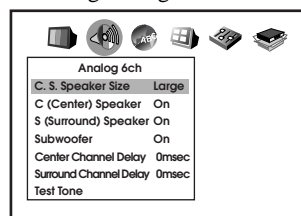

- 1 Select an item by pressing ▲/▼, and press **ENTER**.
- 2 Make the setting (see below) by pressing (▲/▼/◀/▶), and press **ENTER**.

C. S. Speaker Size

Small: When the center speaker or surround speakers cannot reproduce low frequency signals below 120 Hz.

Large: When the center speaker and surround speakers can reproduce low frequency signals below 120 Hz.

C (Center) Speaker

Off: When center speaker is not connected.

On: When you connect center speaker.

S (Surround) Speaker

Off: When surround speakers are not connected.

On: When you connect surround speakers.

Subwoofer

Off: When a subwoofer is not connected.

On: When you connect a subwoofer.

Note

Depending on the DVD-Audio, the audio may be output based only on the channel information recorded on the disc regardless of the speaker settings.



Adjusting the delay time:

When enjoying 5.1ch surround playback, it is ideal to choose a listening position that is the same distance from each speaker. By adjusting the delay time of center/surround speakers, you can virtually create an ideal listening environment (as if the center/surround speakers were at their ideal locations respectively as below).

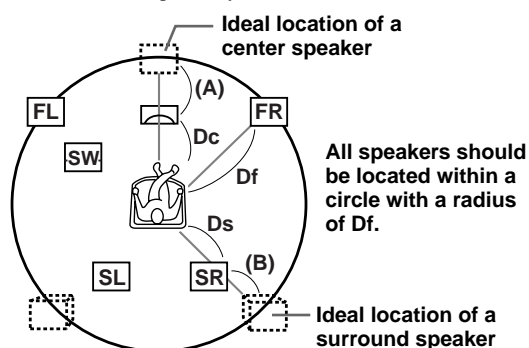

Center Channel Delay

- 0 msc:** When Df equals Dc.
- 1 msc:** When (A) is approx. 34 cm (13 inch)
- 2 msc:** When (A) is approx. 68 cm (27 inch)
- 3 msc:** When (A) is approx. 102 cm (40 inch) . . .

$*(A)=Df - Dc$

Get your optimum value (0, 1, 2 . . . 5) dividing (A) by 34.

Surround Channels Delay

- 0 msc:** When Df equals Ds.
- 1 msc:** When (B) is approx. 34 cm (13 inch)
- 2 msc:** When (B) is approx. 68 cm (27 inch)
- 3 msc:** When (B) is approx. 102 cm (40 inch)

$*(B)=Df - Ds$

Get your optimum value (0, 1, 2 . . . 15) dividing (B) by 34.

Note

Depending on the DVD-Audio, the audio may be output with delay times of 0 ms regardless of the setting.

- 3 Select "Test Tone" and press **ENTER**.
The DVD Player outputs a test signal to each speaker when it is in stop mode. When playing a DVD-Video, it substitutes the current sound for the test signal.
Press **◀▶** to select the receiving speakers, and adjust the volume of each speaker at the same level by pressing **▲▼**.
If all the volume levels cannot be equalized, adjust them on the amplifier.
Press **ENTER** again to turn off the test tone once adjustments are complete.

Note

Depending on the disc, 6 channel sounds may not be output via the MULTI CHANNEL OUTPUT/ANALOG OUTPUT jacks.

Dynamic Range Control



- Off:** Full dynamic range is maintained.
- On:** Dynamic range is reduced.

Notes

- This function works only during playback of Dolby Digital recorded discs.
- The level of Dynamic Range Reduction may differ depending on the DVD.

Karaoke Vocal



- Off:** The primary vocal is not output.
- On:** The primary vocal is output when it is recorded on the disc.

Notes

- The vocal output feature is used during playback of Dolby Digital (multi-channel) recorded DVD KARAOKE discs. This feature allows you to turn off vocal audio tracks, or restore them for background accompaniment.
- When playing KARAOKE, connect appropriate audio equipment such as an amplifier to the DVD player.



Customizing the Function Settings

Explanation of Each Item in the Language Category

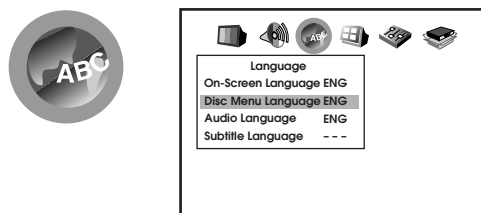

On-Screen Language



- English:** To view on-screen displays in English.
- Français:** To view on-screen displays in French.
- Español:** To view on-screen displays in Spanish.

Disc Menu Language



- English:** To display disc menus in English.
- French:** To display disc menus in French.
- Spanish:** To display disc menus in Spanish.
- Others:** To make a further choice.

After pressing **ENTER**, follow steps 1 - 4 below.

- 1 Obtain the abbreviation of the preferred language from “Table of Languages” on page 55.
- 2 Select the first character by pressing ▲/▼.
- 3 Press ◀▶ to shift and select the second character by pressing ▲/▼.

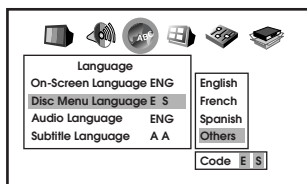

- 4 Press **ENTER**.

Note

Some DVD-Video may not include your pre-selected language. In this case, the DVD Player automatically displays disc menus consistent with the disc’s initial language setting.

Audio Language



- English:** To play sound tracks in English.
- French:** To play sound tracks in French.
- Spanish:** To play sound tracks in Spanish.
- Others:** To make a further choice.

After pressing **ENTER**, follow steps 1 - 4 below.

- 1 Obtain the abbreviation of the preferred language from “Table of Languages” on page 55.
- 2 Select the first character by pressing ▲/▼.
- 3 Press ◀▶ to shift and select the second character by pressing ▲/▼.

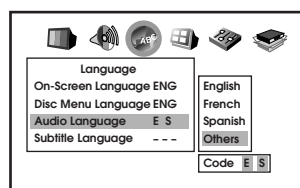

- 4 Press **ENTER**.

Note

Depending on the disc, a language recorded on the disc may be given priority and selected automatically when the disc is loaded regardless of the setting.



Explanation of Each Item in the Display Category

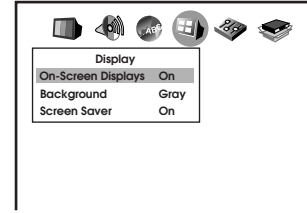

Subtitle Language DVD-V

- English:** To display subtitles in English.
- French:** To display subtitles in French.
- Spanish:** To display subtitles in Spanish.
- No Subtitles:** To disable subtitles.
- Others:** To make a further choice.
After pressing **ENTER**, follow steps 1 - 4 below.

- 1 Obtain the abbreviation of the preferred language from "Table of Languages" on page 55.
- 2 Select the first character by pressing ▲/▼.
- 3 Press ◀/▶ to shift and select the second character by pressing ▲/▼.

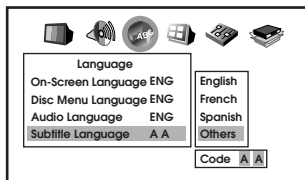

- 4 Press **ENTER**.

Notes

- Some DVD-Video may be set to display subtitles in a different language than you selected. A prior subtitle language may be programmed on the disc.
- Some DVD-Video allow you to change subtitle selections only via the disc menu. If this is the case, Press **MENU** and choose the appropriate subtitle language from the selection on the disc menu.

On-Screen Displays DVD-V DVD-A VCD CD

- Off:** Operational modes (e.g. "▶", "⊞") are not displayed.
- On:** Operational modes (e.g. "▶", "⊞") are displayed on-screen.

Background DVD-V DVD-A VCD CD

- Blue:** Blue background.
- Gray:** Gray background.
- Capture:** To use a picture you sample and store in the memory using the Capture feature as a background (see page 41).
- Jacket:** To use the jacket picture included on some discs as a background. If it is not included, a gray background will be substituted.

Screen Saver DVD-V

- Off:** The screen saver is disengaged.
- On:** The screen saver operates.



Customizing the Function Settings

Explanation of Each Item in the Operation Category

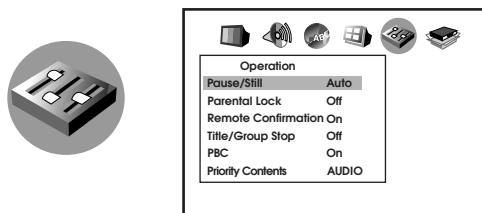

Pause/Still DVD-V

- Auto:** For normal use. Still and fast motion images can be paused.
- Frame:** The resolution of still pictures is improved, so that you can make a motionless picture clearer when you pause it.

Parental Lock DVD-V

DVD-Video equipped with the parental lock function are rated according to their content. The content allowed by a parental lock level and the way a DVD-Video can be controlled may vary from disc to disc. For example, some discs allow you to edit out violent scenes unsuitable for children and replace them with more suitable scenes, or lock out playback of the disc altogether.

Note

DVD-Video may or may not respond to the parental lock setting. This is not a defect in the DVD Player. Make sure this function works with your DVD-Video.

- Off:** The parental lock feature does not function. After pressing **ENTER**, follow step 1 below.
- On:** To activate the parental lock feature or change the settings. After pressing **ENTER**, follow steps 1 - 3 below.

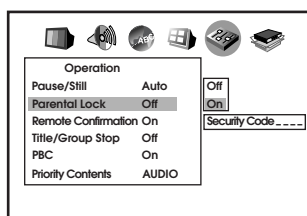

- 1 Press the number buttons to create a personal 4-digit security code, then press **ENTER**.
If you make a mistake before pressing the **ENTER** button, press **CLEAR** and enter your 4-digit security code again.
- 2 Enter the code of an area whose standards were used to rate the DVD-Video, referring to the list below.

Area	Code
AUSTRALIA	AU
BELGIUM	BE
CANADA	CA
CHINA	CN
DENMARK	DK
FINLAND	FI
FRANCE	FR
GERMANY	DE
HONG KONG	HK
INDONESIA	ID
ITALY	IT
JAPAN	JP
MALAYSIA	MY
NETHERLANDS	NL
NORWAY	NO
PHILIPPINES	PH
RUSSIAN FEDERATION	RU
SINGAPORE	SG
SPAIN	ES
SWEDEN	SE
SWITZERLAND	CH
TAIWAN	TW
THAILAND	TH
UNITED KINGDOM	GB
UNITED STATES	US

- a Select the first character by pressing **▲/▼**.
- b Press **◀▶** to shift and select the second character by pressing **▲/▼**.
- c Press **ENTER**.



- 3 Press ▲/▼ to select the parental lock level, then press **ENTER**.

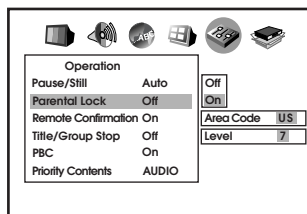

You cannot play DVD Video rated higher than the level you selected unless you cancel the parental lock function.
For example, when you select level 7, discs rated higher than level 7 are locked out and cannot be played.

The parental lock level is equivalent to the following U.S. movie ratings.

- Level 7: NC-17
- Level 6: R
- Level 4: PG 13
- Level 3: PG
- Level 1: G

The parental lock levels for other areas than U.S. are included for future use. Check the appropriate parental lock level when you buy a DVD-Video equipped with the parental lock feature in the future.

■ To change the parental lock level

Follow step 1 - 3.

■ To change your 4-digit security code

- 1 After selecting "On" or "Off", press ■ four times, then press **ENTER**.

The 4-digit security code is cleared.

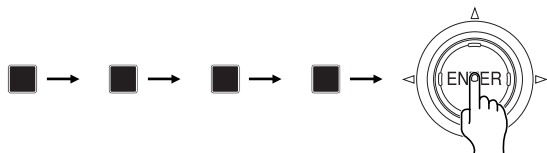

- 2 Press the number buttons to create a new 4-digit security code.
- 3 Press **ENTER**.

Remote Confirmation



Off: The beeper does not sound.

On: The beeper sounds with each remote operation.

Title/Group Stop



Off: The DVD Player continues after playback of a title/group is complete.

On: The DVD Player stops after playback of a title/group is complete.

PBC



Off: When playing a Video-CD without using the menu.

On: To use the menu when playing a PBC-featured Video-CD.

Priority Contents



Select the playback priority between DVD-Video and DVD-Audio format signals when playing a DVD disc that contains both DVD-Video and DVD-Audio format signals.

DVD-AUDIO: DVD Audio format signals take priority over DVD Video format signals.

DVD-VIDEO: DVD Video format signals take priority over DVD Audio format signals.



Customizing the Function Settings

Explanation of Each Item in the Initial Setup Category

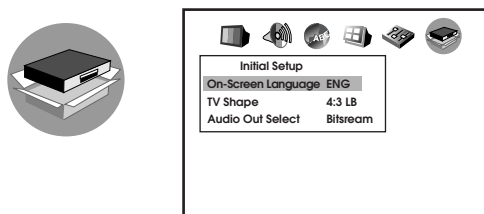

Initial Setup

DVD-V DVD-A VCD CD

- 1 Press ▲/▼ to select “On-Screen Language”, then press **ENTER**.

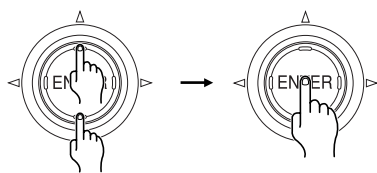

- 2 Press ▲/▼ to select a language, then press **ENTER**.

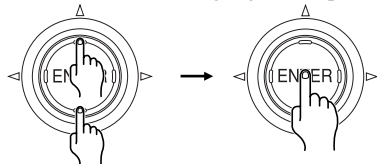

For details, see “On-Screen Language” on page 50.

- 3 Press ▼ to select “TV Shape”, then press **ENTER**.

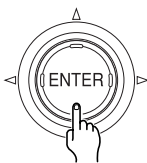

- 4 Press ▲/▼ to select the aspect ratio of the TV screen, then press **ENTER**.

For details, see “TV Shape” on page 46.

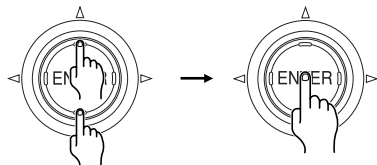

- 5 Press ▼ to select “Audio Out Select”, then press **ENTER**.



- 6 Press ▲/▼ to select the audio output, then press **ENTER**.

For details, see “Audio Out Select” on page 48.

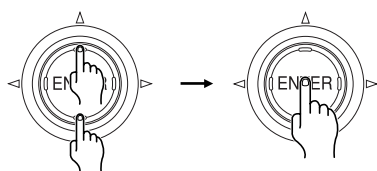

- 7 Finally press **SETUP**.

Table of Languages

Table of Languages and Their Abbreviations

Abbreviation of the Language	Language	Abbreviation of the Language	Language	Abbreviation of the Language	Language	Abbreviation of the Language	Language
—	No alternate language	EO	Esperanto	LN	Lingala	SL	Slovenian
CHI (ZH)	Chinese	ET	Estonian	LO	Laotian	SM	Samoan
DUT (NL)	Dutch	EU	Basque	LT	Lithuanian	SN	Shona
ENG (EN)	English	FA	Persian	LV	Latvian, Lettish	SO	Somali
FRE (FR)	French	FI	Finnish	MG	Malagasy	SQ	Albanian
GER (DE)	German	FJ	Fiji	MI	Maori	SR	Serbian
ITA (IT)	Italian	FO	Faroese	MK	Macedonian	SS	Siswati
JPN (JA)	Japanese	FY	Frisian	ML	Malayalam	ST	Sesotho
KOR (KO)	Korean	GA	Irish	MN	Mongolian	SU	Sundanese
MAY (MS)	Malay	GD	Scottish, Gaelic	MO	Moldavian	SV	Swedish
SPA (ES)	Spanish	GL	Galician	MR	Marathi	SW	Swahili
AA	Afar	GN	Guarani	MT	Maltese	TA	Tamil
AB	Abkhazian	GU	Gujarati	MY	Burmese	TE	Telugu
AF	Afrikaans	HA	Hausa	NA	Nauru	TG	Tajik
AM	Amharic	HI	Hindi	NE	Nepali	TH	Thai
AR	Arabic	HR	Croatian	NO	Norwegian	TI	Tigrinya
AS	Assamese	HU	Hungarian	OC	Occitan	TK	Turkmen
AY	Aymara	HY	Armenian	OM	(Afan) Oromo	TL	Tagalog
AZ	Azerbaijani	IA	Interlingua	OR	Oriya	TN	Setswana
BA	Bashkir	IE	Interlingue	PA	Panjabi	TO	Tongan
BE	Belorussian	IK	Inupiak	PL	Polish	TR	Turkish
BG	Bulgarian	IN	Indonesian	PS	Pashto, Pushto	TS	Tsonga
BH	Bihari	IS	Icelandic	PT	Portuguese	TT	Tatar
BI	Bislama	IW	Hebrew	QU	Quechua	TW	Twi
BN	Bengali, Bangla	JI	Yiddish	RM	Rhaeto-Romance	UK	Ukrainian
BO	Tibetan	JW	Javanese	RN	Kirundi	UR	Urdu
BR	Breton	KA	Georgian	RO	Rumanian	UZ	Uzbek
CA	Catalan	KK	Kazakh	RU	Russian	VI	Vietnamese
CO	Corsican	KL	Greenlandic	RW	Kinyarwanda	VO	Volapük
CS	Czech	KM	Cambodian	SA	Sanskrit	WO	Wolof
CY	Welsh	KN	Kannada	SD	Sindhi	XH	Xhosa
DA	Danish	KS	Kashmiri	SG	Sango	YO	Yoruba
DZ	Bhutani	KU	Kurdish	SH	Serbo-Croatian	ZU	Zulu
EL	Greek	KY	Kirghiz	SI	Singhalese		
		LA	Latin	SK	Slovak		

Using the Remote Controller

This section explains how to get the best use out of the supplied remote controller. In addition to being able to operate the DVD Player, it is also equipped to handle a number of the functions of an Integra receiver. The remote controller can also be set up to "learn" a number of remote commands to control the components of other manufacturers.

Using the remote controller to operate the DVD player

Before attempting to operate the DVD Player, press DVD to set the remote controller to operate the DVD Player. The following buttons can be used to operate the DVD Player. Refer to the pages in brackets [] for details on each function.

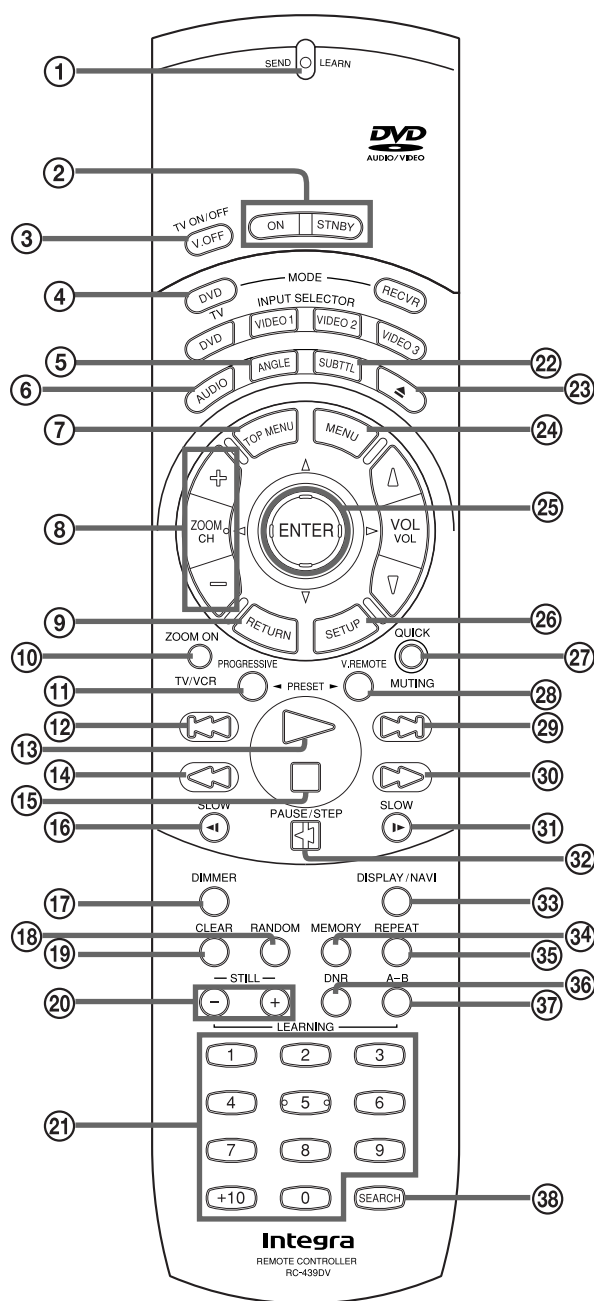

- ① **SEND/LEARN indicator [58]**
Lights when the remote controller is sending a command to the DVD Player or other preprogrammed component, and when learning the command of another remote control unit.
- ② **ON/STNBY buttons [17]**
Press **ON** to turn the DVD Player on and **STNBY** to put the DVD Player in standby. (The Standby indicator lights up.)
- ③ **V.OFF (TV ON/OFF) button [43]**
Press to turn off the video output circuitry for a more dedicated audio performance. This button can also be used to learn the commands to turn your TV or monitor on and off.
- ④ **DVD button [58]**
Press to select the DVD mode. In this mode, the remote controller is set to control the DVD Player.
- ⑤ **ANGLE button [32]**
Press repeatedly to select a camera angle when a DVD-Video is recorded with multiple angle playback.
- ⑥ **AUDIO button [34]**
Press repeatedly to select an audio and/or language track recorded on a DVD-Audio/Video.
- ⑦ **TOP MENU button [18]**
Press to select the top menu on a DVD-Video. This menu may be the same as the DVD menu.
- ⑧ **ZOOM (CH) +/- buttons [30]**
When the Zoom function is turned on, use these buttons to enlarge and reduce the screen image.
- ⑨ **RETURN button [18]**
Press to go back to a previous menu screen.
- ⑩ **ZOOM ON button [30]**
Press to turn the Zoom function on and off.
- ⑪ **PROGRESSIVE button [42]**
Press to select progressive scan from the DVD Player.
- ⑫ **◀◀ (skip back) button [26]**
Press to return to previous titles, groups, chapters, or tracks.
- ⑬ **▶▶ (play) button [20]**
Press to start playback.
- ⑭ **◀◀ (fast reverse) button [22]**
Press to scan rapidly backward through the contents on a disc.
- ⑮ **■ (stop) button [21]**
Press to stop playback.
- ⑯ **SLOW ◀ button [22]**
Press to perform slow reverse playback of a DVD.
- ⑰ **DIMMER button [16]**
Press repeatedly to change the brightness of the front panel display in four grades (including turning the front panel display off). The dimmer setting is restored to normal brightness whenever the DVD Player is turned off.
- ⑱ **RANDOM button [29]**
Press to start random playback.
- ⑲ **CLEAR button [25-30]**
Press to clear entered values and settings.
- ⑳ **STILL +/- buttons [22]**
When still pictures have been recorded on a DVD-Audio, use these buttons to select the picture.



Remote controller buttons that can be used to control your Integra receiver

- ⑳ **Number buttons [24, 28]**
Use to enter numeric values.
- ㉑ **SUBTTL button [33]**
Press repeatedly to select one of the subtitle languages recorded on a DVD-Video.
- ㉒ **▲ button [21]**
Press to open and close the disc tray.
- ㉓ **MENU button [18]**
Press to display the DVD menu.
- ㉔ **▲/▼/◀▶ and ENTER multi control [18]**
Use to navigate menu screens and enter settings.
- ㉕ **SETUP button [18]**
Press to display the Setup screen menu.
- ㉖ **QUICK button [37]**
Press to display the Quick list of functions relevant to the current playback mode.
- ㉗ **V.REMOTE button [36]**
Press to display the Virtual Remote on the screen.
- ㉘ **▶▶ (skip forward) button [26]**
Press to advance through titles, groups, chapters, or tracks.
- ㉙ **▶▶▶ (fast forward) button [22]**
Press to scan rapidly forward through the contents on a disc.
- ㉚ **SLOW ▶▶ button [22]**
Press to perform slow forward playback of a DVD or Video CD.
- ㉛ **PAUSE/STEP  button [21]**
Press to playback. Pressing repeatedly causes the still video image to be advanced a single frame at a time.
- ㉜ **DISPLAY/NAVI button [38]**
Press to display the on-screen navigational.
- ㉝ **MEMORY button [28]**
Press to playback titles, chapters, or tracks in a specific order.
- ㉞ **REPEAT button [27]**
Press to repeat playback.
- ㉟ **DNR button [31]**
Press repeatedly to select one of the digital noise reduction processes for a clearer video presentation.
- ㊱ **A-B button [27]**
Press to repeat a specific section on a disc.
- ㊲ **SEARCH button [25]**
Press to find the specific section on a disc where you want to start playback.

Press **RECVR** to set the remote controller to operate an Integra receiver. The following buttons can be used to operate an Integra receiver. Refer to the manual supplied with your receiver for details on each function.

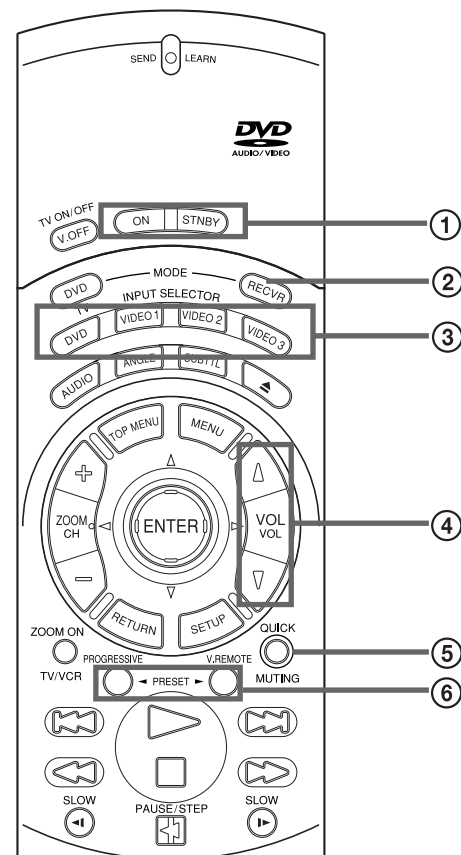

- ① **ON/STNBY buttons**
Press **ON** to turn the receiver on and **STNBY** to put the receiver in standby. Depending on the receiver, pressing **ON** may alternately turn the receiver on and put it in standby.
- ② **RECVR button**
Press to select the Receiver mode. In this mode, the remote controller is set to control an Integra receiver.
- ③ **Input selector buttons**
Press to select the input. These buttons can be used in either DVD or RECEIVER mode.
- ④ **VOL ▲/▼ buttons**
Press to adjust the volume. These buttons can be used in either DVD or RECEIVER mode, and can also be programmed to adjust the volume of other components.
- ⑤ **MUTING button**
Press to mute the audio output.
- ⑥ **PRESET ◀▶ buttons**
Press to select the radio presets if the receiver has radio features.



Programming the Commands of Other Remote Control Units into the Remote Controller

This remote controller features a learning function that allows you to program the remote codes of other remote control units for more singular control of your home entertainment system. A number of commands can be programmed for operation for when the remote controller is in DVD mode and when it is in Receiver mode. Please follow the procedure in this section to program your remote controller to your preferences.

Programming procedure

The first step in the procedure is to determine whether the new command is to be learned in the DVD mode or in the Receiver mode. Generally speaking, this should be decided by the command being learned. After deciding which mode is to be used, you will then transfer the individual commands from the other remote control unit to the RC-439DV remote controller one at a time. Each command is then programmed to one of the available buttons on the RC-439DV remote controller.

Even after the commands have been programmed, keep the other remote control unit in a safe place in the case that the programmed commands should be lost (e.g., when the batteries run down). If the commands are lost, it will then be necessary to program them again.

- 1** Place the remote controller and the other remote control unit of the other component facing each other at a distance of 5 to 15 cm (2 to 6 inches) apart.

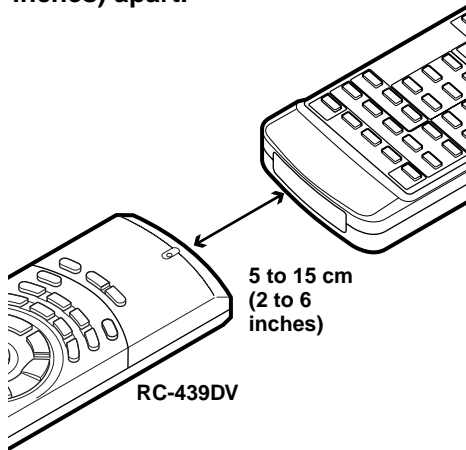

- 2** While pressing and holding down the desired **MODE** button (**DVD** or **RECVR**) on the remote controller, press **SEARCH** and then release both buttons.

When you press and hold down the desired **MODE** button, the **SEND/LEARN** indicator lights up. When you press **SEARCH**, the indicator turns off. When you release both buttons, the indicator lights up again.

- 3** Press and release the button on the remote controller to which you want to transfer the new command.

The buttons that can be selected in this step depend on the mode. Refer to the shaded areas in the illustrations below to determine what buttons can be programmed in each mode.

If you press the wrong button by mistake, press that same button again. The **SEND/LEARN** indicator flashes three times and the remote controller exits the programming mode. When this is the case, start again at step 1.

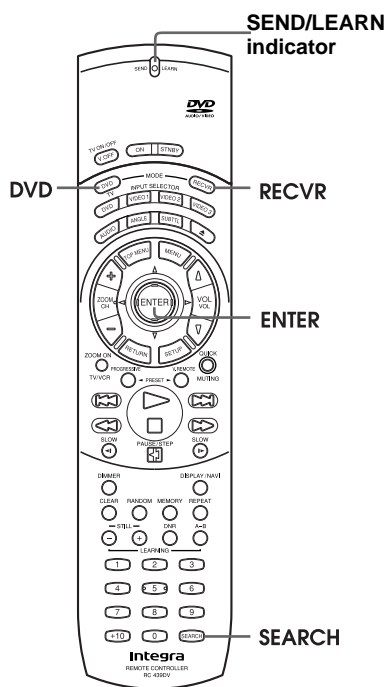

DVD MODE

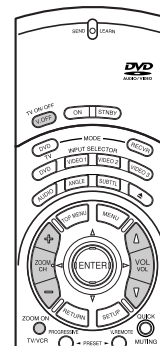

RECEIVER MODE

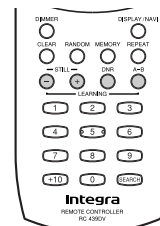

■ : Buttons that can be programmed.



4	<p>Press and hold down the button on the other remote control unit that corresponds to the command you want to program until the SEND/LEARN indicator flashes twice to indicate that the command has been successfully programmed.</p> <p>After flashing twice, the SEND/LEARN indicator lights up again.</p>
5	<p>Repeat steps 3 and 4 to program other commands within the same mode.</p> <p>Repeat step 2 to 4 to program commands to the other mode.</p>
6	<p>Press the MODE button (DVD or RECVR) that you pressed in step 2 to complete the programming.</p>
7	<p>Use the remote controller to perform the newly learned command to confirm that it was learned correctly.</p>

Notes

- Some buttons have already been programmed to control functions of an Integra receiver. Therefore, it is recommended to program additional functions of the receiver that are not already programmed in the remote controller.
- If no buttons are pressed for more than 30 seconds during the programming, or if you perform an invalid operation, the SEND/LEARN indicator flashes three times quickly and the remote controller exits the programming mode. Resume programming from step 2.
- If you perform an invalid operation during programming, the SEND/LEARN indicator flashes three times quickly and the remote controller exits the programming mode. Resume from Step 2.
- When you want to program a command to a button to which you have already programmed a command, simply follow the same procedure and programming for that button will be overwritten.
- The remote controller uses infrared rays to send its commands, as do most other remote control units. Though most remote control units can be memorized by the remote controller, be aware that some remote control units use a system that is quite different from the remote controller and therefore may not be able to be programmed.
- Some remote control units have a single button that performs multiple functions (for example, the function may change each time the button is pressed). If this is the case, each function must be programmed to a separate button on the remote controller.
- Once you have programmed the commands from the other remote control unit, refer to the instructions supplied with the other component to operate.
- Make sure that both the remote controller and the other remote control unit have new batteries. If either of them has batteries that are low, you may not be able to program the commands of the other remote control unit properly into the remote controller.
- After programming another function to the **ZOOM ON** button or **ZOOM +/-** buttons, it is no longer possible to perform the Zoom function. To use the Zoom function again, it is necessary to erase the commands programmed to those buttons. For details, see page 60.
- Removing the batteries from the remote controller for at least 10 minutes erases all of the commands that have been programmed in the remote controller.



Programming the Commands of Other Remote Control Units into the Remote Controller

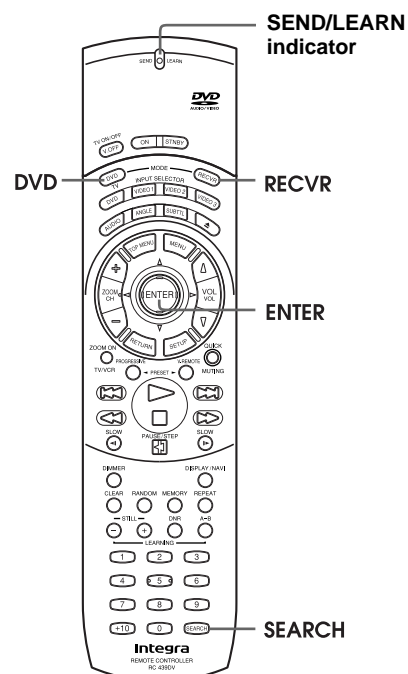

Erasing the programmed command from one button

You can only erase memorized commands and not preset ones.

1	<p>Press and hold down the desired MODE button for the command, press the SEARCH button, and then release both buttons.</p> <p>When you release the buttons, the SEND/LEARN indicator lights.</p>
2	<p>Press and release the button for the command you wish to erase.</p> <p>When you press the button, the SEND/LEARN indicator turns off. When you release the button, the lamp lights again.</p>
3	<p>Press and release the same button again.</p> <p>The SEND/LEARN lamp flashes twice. The memorized command is erased.</p>

Note

If no button is pressed for more than 30 seconds during the programming, the SEND/LEARN indicator flashes three times quickly, and the remote controller exits the programming mode. Resume from Step 1.

Erasing all the commands programmed under a MODE button

1	<p>Press and hold down the desired MODE button, press the SEARCH button twice, and then release both buttons.</p> <p>When you release the buttons, the SEND/LEARN indicator flashes twice slowly and then lights again.</p>
2	<p>Press and release the same MODE button again.</p> <p>When you release the button, the SEND/LEARN indicator flashes twice slowly. This erases all the commands memorized to the MODE button.</p>

Notes

- If no button is pressed for more than 30 seconds, the SEND/LEARN indicator flashes three times quickly and the remote controller exits the programming mode. Resume Step 1.
- If you perform an invalid operation during programming, the SEND/LEARN indicator flashes three times quickly and the remote controller exits the programming mode. Resume from Step 1.
- If many commands have been programmed to the MODE button, then the SEND/LEARN indicator may remain lit for some time during Step 2. This is not a malfunction.

Troubleshooting

Check the following guide for the possible cause of a problem before contacting service. Refer also to the respective instruction manuals of the connected components and TV.

	Symptoms	Causes	Remedies	Pages
DVD Player	The DVD Player doesn't switch on.	<ul style="list-style-type: none"> The power cord is disconnected. The main power is set to OFF. There is external noise in the computer circuits of the DVD Player. The AC fuse is blown. 	<ul style="list-style-type: none"> Check the connection of the power cord. Turn on the main power. Switch off the main power, then switch it on again. If not recovered, disconnect the power cord, then connect it again. Contact your nearest Integra/Onkyo authorized service center. 	17 17 17 –
	The DVD Player doesn't start playback.	<ul style="list-style-type: none"> No disc is inserted. The region number of the disc does not match that of the DVD Player. An unplayable disc is inserted. The disc is placed upside down. The disc is not placed within the disc tray guide. The disc is dirty. The parental lock function is activated. 	<ul style="list-style-type: none"> Insert a disc. (Check that "DVD," "VCD," or "CD" is lit in the DVD Player's display). See "1. Regional Restriction Codes (Region Number)" on page 4. Check the playable discs. Place the disc with the playback side down. Place the disc within the proper guide on the disc tray. Eject the disc and clean it. Deactivate the parental lock function or change the parental lock level. 	20 4 6 20 20 6 52
	Brightness is unstable or noise is visible on the playback picture.	<ul style="list-style-type: none"> Copy protection is activated. 	<ul style="list-style-type: none"> Connect the DVD Player directly to the TV. Avoid connecting the DVD Player to the TV through a VCR. 	10
	The playback picture is occasionally distorted.	<ul style="list-style-type: none"> The disc is dirty. It is in fast forward or fast reverse playback. 	<ul style="list-style-type: none"> Eject the disc and clean it. Sometimes a small amount of picture distortion may appear. This is not a malfunction. 	6 –
	Playback doesn't follow the course of the disc's programs.	<ul style="list-style-type: none"> The DVD Player is in repeat playback mode, memory playback mode, or random playback mode, etc. 	<ul style="list-style-type: none"> Resume normal playback. 	27-29
	The picture from the DVD Player doesn't appear on the TV screen.	<ul style="list-style-type: none"> The TV is not set to receive the output signals from the DVD Player. The DVD Player is not properly connected. The video output circuitry has been switched off. 	<ul style="list-style-type: none"> Set the TV to the DVD Player's input. Check the connections to the DVD Player. Turn the video circuitry on. 	10 10 43
	No sound or inaccurate sound is reproduced.	<ul style="list-style-type: none"> A wrong sound signal conversion method (Audio Out Select) is selected. The TV is not set to receive the output signals from the DVD Player. The DVD Player is not properly connected. 	<ul style="list-style-type: none"> Check the current sound signal conversion method, and select the right setting for "Audio Out Select". Also refer to "Output Sound Conversion Table" on page 35. Set the TV to the DVD Player's input. Check the connections to the DVD Player. 	35, 48 10-13
	The buttons on the remote controller and DVD Player do not operate.	<ul style="list-style-type: none"> Power supply fluctuations or other abnormalities such as static electricity may interrupt correct operation. 	<ul style="list-style-type: none"> Switch off the main power, then switch it on again. If not recovered, disconnect the power cord, then connect it again. 	17
Remote Controller	The buttons on the DVD Player operate but the buttons on the remote controller do not operate.	<ul style="list-style-type: none"> No batteries are inserted in the remote controller. The batteries are worn out. The remote controller is not pointed at the remote sensor of the DVD Player. The remote controller is too far from the DVD Player. 	<ul style="list-style-type: none"> Insert new batteries. Replace with new batteries. Point the remote controller at the remote sensor of the DVD Player. Operate the remote controller within 5 m (16 feet). 	9 9 9 9
	Learned functions of the remote controller do not work.	<ul style="list-style-type: none"> The remote controller is not aimed at the other component. The mode selection is incorrect. Learning was not successful. 	<ul style="list-style-type: none"> Aim the remote controller at the component you wish to operate. Check that the mode is correct for the command you are attempting. Reprogram the command into the remote controller. 	58 58 58

Because the unit contains a microcomputer to provide advanced functions, it may malfunction due to external noise or static electricity. If this happens, press the POWER switch on the unit and then press it again after about five seconds.

Specifications

■ DVD Player

Power supply	AC 120 V, 60 Hz
Power consumption	45 W
Weight	24.7 lbs
External dimensions	17 1/8" x 4 13/16" x 14 7/8" (W/H/D)
Signal system	Standard NTSC
Laser	Semiconductor laser, wavelength 650/780 nm
Frequency range (digital audio)	DVD linear sound: 48 kHz sampling 4 Hz to 22 kHz 96 kHz sampling 4 Hz to 44 kHz 192 kHz sampling 4 Hz to 96 kHz
Signal-to-noise ratio (digital audio)	More than 112 dB
Audio dynamic range (digital audio)	More than 106 dB
Harmonic distortion (digital audio)	Less than 0.002 %
Wow and flutter	Below measurable level (less than ± 0.001 % (W.PEAK))
Operating conditions	Temperature: 5°C to 35°C (41°F to 95°F), Operation status: Horizontal

■ Outputs

Video output	1.0 V (p-p), 75 Ω , negative sync., pin jack $\times 2$
S-video output	(Y) 1.0 V (p-p), 75 Ω , negative sync., Mini DIN 4-pin $\times 2$ (C) 0.286 V (p-p), 75 Ω
Component video output	(Y) 1.0 V (p-p), 75 Ω , negative sync., pin jack $\times 2$ (Pb)/(Pr) 0.7 V (p-p), 75 Ω , pin jack $\times 4$
Audio output (digital output Optical)	Optical connector $\times 2$
Audio output (digital output Coaxial)	0.5 V (p-p), 75 Ω , pin jack $\times 2$
Audio output (2-Channel Audio)	2.0 V (rms), 320 Ω , pin jack (L, R) $\times 2$
Audio output (5.1-Channel Surround)	2.0 V (rms), 320 Ω , pin jack $\times 6$ 2.0 V (rms), 320 Ω , DB25 $\times 1$

■ Supplied Accessories

Audio/video connection cable	1
Remote controller (RC-439DV)	1
Batteries (size AA/UM-3)	2
Power cord	1
S-video cable	1
DB-25 cable	1

Specifications and features are subject to change without notice.





Integra Division of
ONKYO U.S.A. CORPORATION
200 Williams Drive, Ramsey, N.J. 07446, U.S.A.
Tel: 201-825-7950 Fax: 201-825-8150 E-mail: integra@onkyousa.com

Integra Division of
ONKYO CORPORATION
Sales & Product Planning Div. : 2-1, Nisshin-cho, Neyagawa-shi, OSAKA 572-8540, JAPAN
Tel: 072-831-8111 Fax: 072-833-5222

SN 29343004

Printed in Japan
W0009-1



Free Manuals Download Website

<http://myh66.com>

<http://usermanuals.us>

<http://www.somanuals.com>

<http://www.4manuals.cc>

<http://www.manual-lib.com>

<http://www.404manual.com>

<http://www.luxmanual.com>

<http://aubethermostatmanual.com>

Golf course search by state

<http://golfingnear.com>

Email search by domain

<http://emailbydomain.com>

Auto manuals search

<http://auto.somanuals.com>

TV manuals search

<http://tv.somanuals.com>